



[www.vokel.com](http://www.vokel.com)

# Katalog 25

Dio. 2/3







## UVOD

Poštovani,

Predstavljamo Vam novo izdanje **KATALOG 25, dio 2/3** u kojem smo Vam pokušali na najbolji način predstaviti naš široki prodajni asortiman iz područja opreme za kupaonice (kade, tuš kade, tuš kabine, baterije/slavine, namještaji za kupaonice, kupaonička galanterija, ugradni elementi, bojleri i oprema), wellness&spa (masažne kade i kabine, masažni bazeni, saune i sl.).

Smatramo važnim informirati Vas da smo prethodnih godina tiskali jedinstveni katalog VOKEL ali s obzirom na činjenicu da se broj artikala iz našeg prodajnog asortimana značajno povećao odlučili smo novi katalog tiskati iz tri dijela:

- **KATALOG 25 – dio 1/3** u kojem se nalazi široki prodajni asortiman iz područja materijala za vodovodne instalacije, transportnih i distribucijskih vodovoda, opreme za centralno grijanje i klimatizaciju, obnovljivih izvora energije, kanalizacije, alata za instalatere i sl.
- **KATALOG 25 – dio 2/3** kojeg smo predstavili na početku ovog uvoda i koji upravo imate pred Vama.
- **KATALOG 25 – dio 3/3** u kojem se nalazi bogati asortiman keramičkih pločica, hidroizolacije, keramičkih ljepila, laminata, profila za keramiku i alata za keramičare.

Uvjereni smo da će Vam ova nova koncepcija kataloga iz tri dijela omogućiti jednostavnije snalaženje i odabir roba koje želite imati u svom prodajnom asortimanu ili ih želite nabaviti za vlastite potrebe.

Većina proizvoda koje predstavljamo u katalogu imaju fotografiju, šifru Vokel i tvornički broj artikla. Važno je napomenuti da prigodom slanja Vaših narudžbi obvezno koristite šifru Vokel kako bi se izbjegle nepotrebne greške u isporukama. Za artikle koji nisu označeni šifrom Vokel molimo da u narudžbama koristite njihov tvornički broj.

U katalogu smo predstavili samo dio prodajnog programa pojedinih dobavljača. Informacije za artikle koji nisu u katalogu možete pronaći na web stranicama svakog od naših dobavljača ili direktno kontaktirati naš odjel nabave i prodaje.

Proizvodi koje nabavljate od Vokel-a imaju redovito odgovarajuće certifikate i ateste te sve informacije vezane za garantne rokove, održavanje i servisiranje proizvoda.

Nadamo se da će Vam naš novi katalog, u novom poboljšanom izdanju omogućiti bolje snalaženje i uspješno služenje istim.

Hvala na povjerenju!

Direktor Društva VOKEL d.o.o.

Veljko Lončar

## O nama

Vokel d.o.o. je ugledno trgovačko društvo koje već više od dvadeset pet godina djeluje na tržištu BiH i izvan njega, od svog osnutka 1989.godine. Strpljivim radom i upornošću, noseći se sa svim nepoznanicama i poteškoćama na tržištu, Vokel se razvio u prepoznatljivi brand i postao sinonim kvalitete i pouzdanosti. Tijekom 25 godina poslovanja Društvo Vokel je sa svojim partnerima ostvarilo kvalitetnu, poslovnu vezu dobrom komunikacijom i suradnjom. Trenutno Vokel broji preko 150 dugogodišnjih partnera s čijom suradnjom Vokel sigurno korača prema uspješnijoj budućnosti.

Društvo Vokel upošljava preko 230 visoko osposobljenih i motiviranih osoba. Svjesni važnosti razvoja i ulaganja u ljudske potencijale, svojim zaposlenicima omogućava kontinuiranu edukaciju, doprinoseći na taj način kvaliteti usluga za krajnje potrošače i poslovne partnere.

Osnovna djelatnost Društva Vokel d.o.o. je uvoz, izvoz i prodaja materijala za vodovodne instalacije, transportnih i distribucijskih vodovoda, keramike, sanitarija, parketa, laminata te uređaja i opreme za centralno grijanje i klimatizaciju.

Svoje poslovne uspjehe Vokel d.o.o. ostvaruje u 12 poslovnica smještenih u Sarajevu, Mostaru, Banja Luci, Tuzli, Bihaću, Jajcu, Livnu, Brčkom, Prijedoru, Bijeljini i Imotskom te centralnim sjedištem u Vinjanima – Posušju. Navedeni objekti se protežu na 43,280 m<sup>2</sup> popraćeni 111,210 m<sup>2</sup> okolnog zemljišta. Za kvalitetno obavljanje poslovnih obaveza prema kupcima i dobavljačima, Vokel d.o.o. posjeduje preko 40 dostavnih vozila, velikog i malog kapaciteta zapremanja robe, kako bi u što kraćem vremenskom roku isporučio robu svojim kupcima i poslovnim partnerima.

Tijekom 25 godina poslovanja Društvo Vokel je prepoznato od strane tržišta svojom raznovrsnom ponudom asortimana renomiranih svjetskih proizvođača te je steklo veliko povjerenje kod poslovnih partnera. Svoj uspjeh Vokel može zahvaliti dobroj lokalnoj i regionalnoj pokrivenosti tržišta, dosljednosti u provođenju poslovne strategije Uprave Društva, iskustvu i profesionalnosti zaposlenika te timskim radom i planiranjem.

Zahvaljujući gore navedenom Društvo Vokel d.o.o. bilježi svake godine svoj gospodarski rast a 25-tu obljetnicu poslovanja prigodno obilježava otvaranjem novog, modernog salona u svojoj centrali u Vinjanima – Posušju.

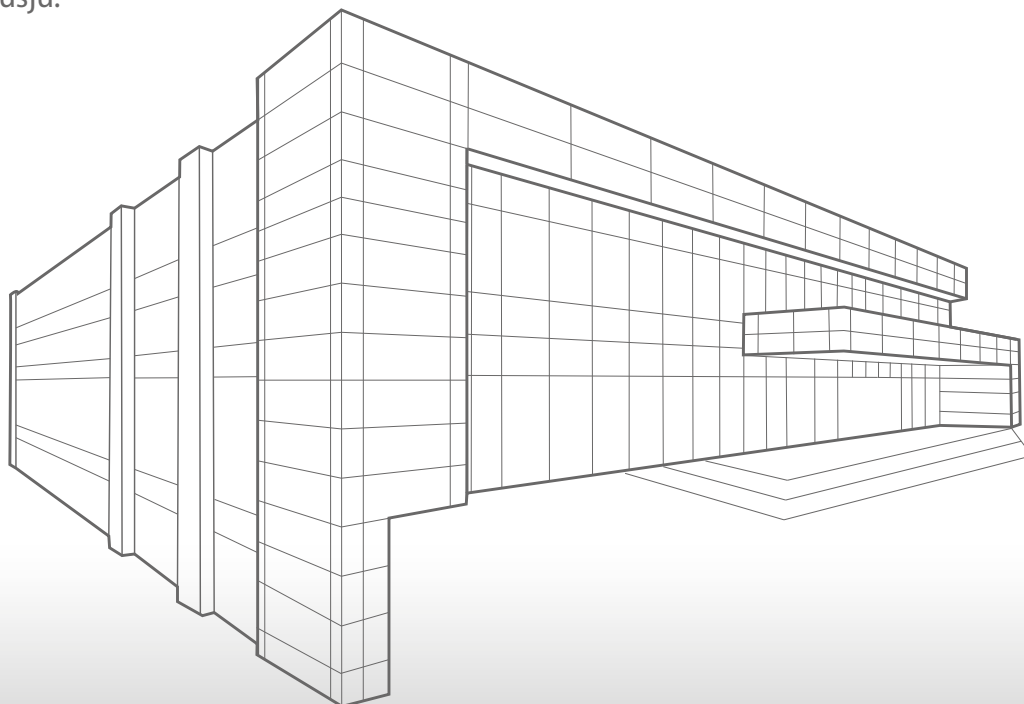



# Sjedište tvrtke Vokel d.o.o.







**VOKEL d.o.o. Laktaši**  
Objekat: 2300 m<sup>2</sup> Zemljišta: 3400 m<sup>2</sup>



**VOKEL d.o.o. Prijedor**  
Objekat: 1250 m<sup>2</sup> Zemljišta: 3800 m<sup>2</sup>



**VOKEL d.o.o. Bihać**  
Objekat: 1350 m<sup>2</sup> Zemljišta: 5100 m<sup>2</sup>

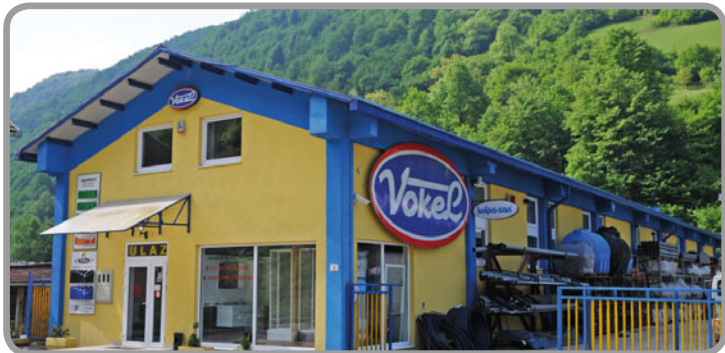

**VOKEL d.o.o. Jajce**  
Objekat: 820 m<sup>2</sup> Zemljišta: 1350 m<sup>2</sup>



[www.vokel.com](http://www.vokel.com)

## Prodajni centri

**VOKEL d.o.o. VINJANI - POSUŠJE**  
Objekti: 28 500 m<sup>2</sup> Zemljišta: 77 000 m<sup>2</sup>



**CENTRALA VOKEL d.o.o.**







**VOKEL d.o.o. Livno**  
Objekat: 450 m<sup>2</sup> Zemljišta: 700 m<sup>2</sup>



**VOKEL d.o.o. Brčko**  
Objekat: 2550 m<sup>2</sup> Zemljišta: 7901 m<sup>2</sup>



**VOKEL d.o.o. Bijeljina**  
Objekat: 1500 m<sup>2</sup> Zemljišta: 4900 m<sup>2</sup>



**VOKEL d.o.o. Tuzla**  
Objekat: 350 m<sup>2</sup> Zemljišta: 300 m<sup>2</sup>



**VOKEL d.o.o. Sarajevo**  
Objekat: 2500 m<sup>2</sup> Zemljišta: 4160 m<sup>2</sup>



**VOKEL d.o.o. Mostar**  
Objekat: 1450 m<sup>2</sup> Zemljišta: 2600 m<sup>2</sup>



**VINJANI - POSUŠJE**



# Prodajni centri

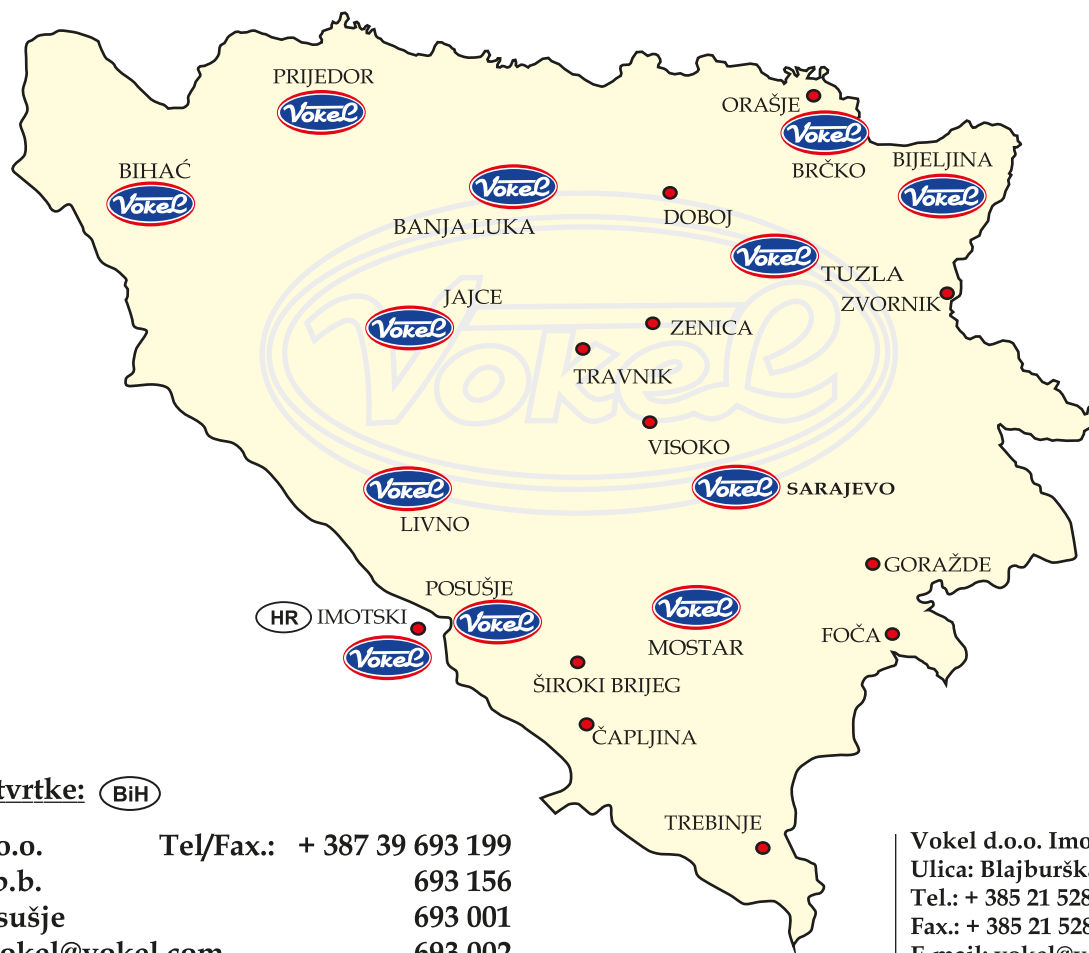

## Sjedište tvrtke: (BiH)

Vokel d.o.o. Tel/Fax.: + 387 39 693 199  
Vinjani b.b. 693 156  
88240 Posušje 693 001  
E-mail: vokel@vokel.com 693 002

Vokel d.o.o. Imotski (HR)  
Ulica: Blajburška ulica 131  
Tel.: + 385 21 528 427  
Fax.: + 385 21 528 198  
E-mail: vokel@vokel.com

## Podružnice: (BiH)

Vokel d.o.o. Sarajevo  
Ulica: Kurta Schorka 5a-Stup  
Tel.: + 387 33 768 605  
Fax: + 387 33 768 606  
E-mail: sarajevo@vokel.com

Vokel d.o.o. Prijedor  
Ulica: Svale b.b.  
Tel.: + 387 52 243 810  
Fax: + 387 52 243 811  
E-mail: prijedor@vokel.com

Vokel d.o.o. Jajce  
Ulica: Skela b.b.  
Tel.: + 387 30 654 088  
Fax.: + 387 30 654 089  
E-mail: jajce@vokel.com

Vokel d.o.o. Brčko  
Ulica: Grbavica b.b.  
Tel.: + 387 49 213 874  
Fax.: + 387 49 213 874  
E-mail: brcko@vokel.com

Vokel d.o.o. Bihać  
Ulica: Pritoka b.b.  
Tel.: + 387 37 328 128  
Fax.: + 387 37 361 784  
E-mail: bihac@vokel.com

Vokel d.o.o. Bijeljina  
Ulica: Ljeljenča b.b.  
Tel.: + 387 55 256 050  
Fax.: + 387 55 256 212  
E-mail: bijeljina@vokel.com

Vokel d.o.o. Livno  
Ulica: Župana Želimira b.b.  
Tel.: + 387 34 202 665  
Fax.: + 387 34 203 042  
E-mail: livno@vokel.com

Vokel d.o.o. Trn-Laktaši  
Ulica: Cara Dušana 74  
Tel.: + 387 51 507 300  
Fax.: + 387 51 507 303  
E-mail: banjaluka@vokel.com

Vokel d.o.o. Tuzla  
Ulica: Mitra Trifunovića Uče 1  
Tel.: + 387 35 398 580  
Fax.: + 387 35 302 045  
E-mail: tuzla@vokel.com

Vokel d.o.o. Mostar  
Ulica: Bišće polje b.b.  
Tel.: + 387 36 351 900  
Fax.: + 387 36 351 903  
E-mail: mostar@vokel.com



<p><b>kolpa·san</b><sup>®</sup> by kolpa</p> <p>KUPAONSKE KADE</p>		<p>Stranica: <b>21-60</b></p>
<p><b>kolpa·san</b><sup>®</sup> by kolpa</p> <p>KUPAONSKE KADE</p>		<p>Stranica: <b>21-60</b></p>
<p><b>kolpa·san</b><sup>®</sup> by kolpa</p> <p>TUŠ KADE</p>		<p>Stranica: <b>61-74</b></p>
<p><b>kolpa·san</b><sup>®</sup> by kolpa</p> <p>TUŠ KADE</p>		<p>Stranica: <b>61-74</b></p>
<p><b>kolpa·san</b><sup>®</sup> by kolpa</p> <p>MASAŽNE KADE I SISTEMI</p>		<p>Stranica: <b>75-78</b></p>
<p><b>kolpa·san</b><sup>®</sup> by kolpa</p> <p>MASAŽNE KABINE, PARNE SAUNE, MASAŽNE STIJENKE</p>		<p>Stranica: <b>79-88</b></p>
<p><b>kolpa·san</b><sup>®</sup> by kolpa</p> <p>MASAŽNE KABINE, PARNE SAUNE, MASAŽNE STIJENKE</p>		<p>Stranica: <b>79-88</b></p>
<p><b>kolpa·san</b><sup>®</sup> by kolpa</p> <p>TUŠ KABINE</p>		<p>Stranica: <b>89-132</b></p>
<p><b>kolpa·san</b><sup>®</sup> by kolpa</p> <p>TUŠ KABINE</p>		<p>Stranica: <b>89-132</b></p>
<p><b>kolpa·san</b><sup>®</sup> by kolpa</p> <p>KUPAONSKI NAMJEŠTAJ</p>		<p>Stranica: <b>133-176</b></p>
<p><b>kolpa·san</b><sup>®</sup> by kolpa</p> <p>KUPAONSKI NAMJEŠTAJ</p>		<p>Stranica: <b>133-176</b></p>











 <b>inda</b> bathroom interiors <b>TUŠ KABINE</b>		Stranica: <b>177-178</b>
<b>BELLAVIA</b> <b>TUŠ KABINE</b>		Stranica: <b>179-182</b>
 <b>HAFRO</b> MASAŽNE KABINE, PARNE SAUNE, MASAŽNE STIJKENKE		Stranica: <b>183-195</b>
 <b>Jacuzzi</b> MASAŽNI SISTEMI		Stranica: <b>196</b>
 <b>myline Wellis</b> MASAŽNI SISTEMI		Stranica: <b>197</b>
 <b>treeesse</b> MASAŽNI SISTEMI		Stranica: <b>198</b>
 <b>weka</b> SAUNE		Stranica: <b>199-201</b>
 <b>ROYO GROUP</b> Bath & Habitat Design KUPAONSKI NAMJEŠTAJ		Stranica: <b>202-208</b>
 <b>PROGETTO IDEA STELLA</b> KUPAONSKI NAMJEŠTAJ		Stranica: <b>209-242</b>
 <b>omegapaneli</b> KUPAONSKI NAMJEŠTAJ		Stranica: <b>243-244</b>
 <b>gala</b> UMIVAONICI, WC ŠKOLJKE, BIDEI		Stranica: <b>245-249</b>









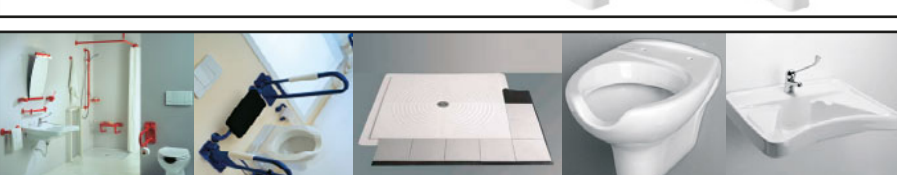



<p><b>UGRADNI I NADGRADNI UMIVAONICI</b></p>		<p>Stranica: <b>250-251</b></p>
<p> <b>QUARELLA</b> POVRŠINSKE PLOČE MRAMOR/SMOLA • QUARTZ/SMOLA</p>		<p>Stranica: <b>252-254</b></p>
<p><b>kristal</b><sup>®</sup> Vaš svijet stakla <b>OGLEDALA</b></p>		<p>Stranica: <b>255</b></p>
<p><b>INKER zoom</b> SERIJA JULIA</p>		<p>Stranica: <b>260-264</b></p>
<p><b>INKER zoom</b> SERIJA SARA</p>		<p>Stranica: <b>265-267</b></p>
<p><b>INKER zoom</b> SERIJA VALENTINA</p>		<p>Stranica: <b>268-271</b></p>
<p><b>INKER zoom</b> SERIJA POLO</p>		<p>Stranica: <b>272-277</b></p>
<p><b>INKER zoom</b> INDIVIDUALNI ARTIKLI</p>		<p>Stranica: <b>278-284</b></p>
<p><b>INKER zoom</b> SERIJA NEO</p>		<p>Stranica: <b>285-289</b></p>
<p> <b>DURAVIT</b> SERIJA DELOS, PURA VIDA</p>		<p>Stranica: <b>294</b></p>
<p> <b>DURAVIT</b> SERIJA STARCK 2, STARCK 3</p>		<p>Stranica: <b>295-296</b></p>









 <b>DURAVIT</b> SERIJA D-CODE, D-CODE COMPACT		Stranica: <b>297-298</b>
 <b>DURAVIT</b> SERIJA DURASTYLE, DURASTYLE BASIC		Stranica: <b>299-300</b>
<i>hatria</i> SERIJA FUSION		Stranica: <b>302-303</b>
<i>hatria</i> SERIJA FUSION 48		Stranica: <b>304</b>
<i>hatria</i> SERIJA FUSION Q		Stranica: <b>305</b>
<i>hatria</i> SERIJE GRANDANGOLO I G-FULL		Stranica: <b>306</b>
<i>hatria</i> SERIJA SCULTURE		Stranica: <b>307-310</b>
<i>hatria</i> SERIJA DAYTIME		Stranica: <b>311-312</b>
<i>hatria</i> SERIJA DOLCEVITA		Stranica: <b>313-315</b>
<i>hatria</i> SERIJA HAPPY HOUR		Stranica: <b>316-318</b>
<i>hatria</i> SERIJA NIDO		Stranica: <b>319-322</b>























<p><i>hatria</i> SERIJA ERIKA PRO Q</p>		<p>Stranica: <b>323-325</b></p>
<p><i>hatria</i> SERIJA ERIKA PRO</p>		<p>Stranica: <b>326-328</b></p>
<p><i>hatria</i> SERIJA ERIKA</p>		<p>Stranica: <b>329-330</b></p>
<p><i>hatria</i> SERIJE CAROLINE, OVALINE, MARINE</p>		<p>Stranica: <b>331</b></p>
<p><i>hatria</i> SERIJA SOPHIE</p>		<p>Stranica: <b>332</b></p>
<p><i>hatria</i> SERIJA DROP</p>		<p>Stranica: <b>333-334</b></p>
<p><i>hatria</i> SERIJA LIF.ST</p>		<p>Stranica: <b>335-337</b></p>
<p>@ galassia KERAMIČKE TUŠ KADE</p>		<p>Stranica: <b>338-339</b></p>
<p><b>LAUFEN</b> Bathroom Culture since 1892  www.laufen.com SERIJA IL BAGNO ALESSI</p>		<p>Stranica: <b>340-341</b></p>
<p><b>LAUFEN</b> Bathroom Culture since 1892  www.laufen.com SERIJA PALOMBA</p>		<p>Stranica: <b>342-343</b></p>
<p><b>LAUFEN</b> Bathroom Culture since 1892  www.laufen.com KARTELL BY LAUFEN</p>		<p>Stranica: <b>344</b></p>



















<p><b>LAUFEN</b> Bathroom Culture since 1892  www.laufen.com</p> <p>SERIJA LAUFEN PRO</p>		<p>Stranica: <b>345-348</b></p>
<p><b>Roca</b></p> <p>SERIJA SENSO COMPACTO, CHIC</p>		<p>Stranica: <b>350</b></p>
<p><b>Roca</b></p> <p>SERIJA DAMA SENSO</p>		<p>Stranica: <b>351</b></p>
<p><b>Roca</b></p> <p>SERIJA HALL</p>		<p>Stranica: <b>352-353</b></p>
<p><b>Roca</b></p> <p>SERIJA MERIDIAN</p>		<p>Stranica: <b>354-356</b></p>
<p><b>Roca</b></p> <p>SERIJA NEXO</p>		<p>Stranica: <b>357-358</b></p>
<p><b>Roca</b></p> <p>SERIJA THE GAP</p>		<p>Stranica: <b>359</b></p>
<p><b>Roca</b></p> <p>SERIJA TIPO</p>		<p>Stranica: <b>360</b></p>
<p><b>Roca</b></p> <p>SERIJA VICTORIA</p>		<p>Stranica: <b>361</b></p>
<p><b>Roca</b></p> <p>SERIJA ACCESS</p>		<p>Stranica: <b>362</b></p>
<p><b>PONTE GIULIO</b><sup>®</sup> spa</p> <p>OPREMA ZA OSOBE S POSEBNIM POTREBAMA</p>		<p>Stranica: <b>363-365</b></p>



















<p><b>BEMETA®</b> OPREMA ZA OSOBE S POSEBNIM POTREBAMA</p>		<p>Stranica: <b>366-369</b></p>
<p><b>HARO®</b> WC DASKE</p>		<p>Stranica: <b>370-372</b></p>
<p><b>RAZNO WC DASKE</b></p>		<p>Stranica: <b>373</b></p>
<p><b>BACCHETTA®</b> KUPAONSKE ZAVJESE</p>		<p>Stranica: <b>374</b></p>
<p><b>GROHE</b> <i>Pure Freude an Wasser</i> SERIJA BAUEDGE</p>		<p>Stranica: <b>376-377</b></p>
<p><b>GROHE</b> <i>Pure Freude an Wasser</i> SERIJA EUROSMART</p>		<p>Stranica: <b>378</b></p>
<p><b>GROHE</b> <i>Pure Freude an Wasser</i> SERIJA EUROSMART COSMOPOLITAN</p>		<p>Stranica: <b>379</b></p>
<p><b>GROHE</b> <i>Pure Freude an Wasser</i> SERIJA EUROSTYLE COSMOPOLITAN</p>		<p>Stranica: <b>381-382</b></p>
<p><b>GROHE</b> <i>Pure Freude an Wasser</i> SERIJA ESSENCE</p>		<p>Stranica: <b>383-384</b></p>
<p><b>GROHE</b> <i>Pure Freude an Wasser</i> SERIJA EUROCUBE</p>		<p>Stranica: <b>385-386</b></p>
<p><b>GROHE</b> <i>Pure Freude an Wasser</i> SERIJA LINEARE</p>		<p>Stranica: <b>387</b></p>









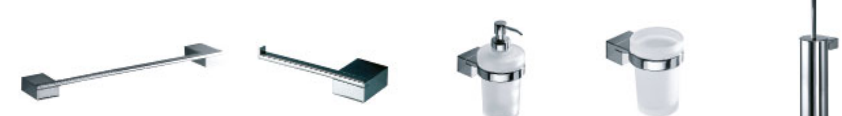













<p><b>GROHE</b> Pure Freude an Wasser SERIJA CONCETTO</p>		<p>Stranica: <b>388-389</b></p>
<p><b>GROHE</b> Pure Freude an Wasser TERMOSTATSKE I SPECIJALNE BATERIJE</p>		<p>Stranica: <b>390-391</b></p>
<p><b>GROHE</b> Pure Freude an Wasser KUHNJSKE BATERIJE</p>		<p>Stranica: <b>392-394</b></p>
<p><b>GROHE</b> Pure Freude an Wasser  TUŠ SUSTAVI</p>		<p>Stranica: <b>395-397</b></p>
<p><b>GROHE</b> Pure Freude an Wasser PODŽBUKNI MEHANIZMI, VENTILI I BATERIJE</p>		<p>Stranica: <b>398-401</b></p>
<p><b>GROHE</b> Pure Freude an Wasser IZLJEVI, KONZOLE, TUŠ RUČICE I SL.</p>		<p>Stranica: <b>402-407</b></p>
<p><b>paffoni</b> SERIJA LEVEL</p>		<p>Stranica: <b>408-412</b></p>
<p><b>paffoni</b> SERIJA BERRY</p>		<p>Stranica: <b>413-417</b></p>
<p><b>paffoni</b> SERIJA CANDY</p>		<p>Stranica: <b>418-421</b></p>
<p><b>paffoni</b> SERIJA SLY</p>		<p>Stranica: <b>422-424</b></p>

















 <b>SERIJA BIRILLO</b>		Stranica: <b>425-426</b>
 <b>SERIJA DUEMILA</b>		Stranica: <b>427-430</b>
 <b>SERIJA BELINDA, IRIS</b>		Stranica: <b>431-434</b>
 <b>SERIJE FYNE, LIGHT</b>		Stranica: <b>435-437</b>
 <b>SERIJE APOLLO 3, EQUO</b>		Stranica: <b>438-439</b>
 <b>IZLJEVI, KONZOLE, TUŠ RUČICE I SL.</b>		Stranica: <b>440-443</b>
 <b>SERIJA PRESTIGE</b>		Stranica: <b>446-448</b>
 <b>SERIJA FRESH</b>		Stranica: <b>449-456</b>
 <b>SERIJA SIMPATY</b>		Stranica: <b>457-461</b>
 <b>SERIJA HARMONY</b>		Stranica: <b>462-465</b>
 <b>SERIJA PROJECT</b>		Stranica: <b>466-469</b>

 <b>UNITAS</b> SERIJA INFINITY		Stranica: <b>470-471</b>
 <b>UNITAS</b> ZIDNE I USADNE SLAVINE		Stranica: <b>472-474</b>
 <b>UNITAS</b> UGRADNE I SENZORSKE BATERIJE		Stranica: <b>475-479</b>
 <b>UNITAS</b> SERIJA STIL		Stranica: <b>480-484</b>
 <b>UNITAS</b> SERIJA VAL		Stranica: <b>485-489</b>
 <b>UNITAS</b> KLASIČNE BATERIJE		Stranica: <b>490-492</b>
 <b>UNITAS</b> IZLJEVI, KONZOLE, TUŠ RUČICE I SL.		Stranica: <b>493-496</b>
 <b>UNITAS</b> VENTILI, I REZERVNI DIJELOVI		Stranica: <b>497-500</b>
 <b>GRB</b> intelligentmixers SERIJA ENTER PLUS		Stranica: <b>501-503</b>
 <b>GRB</b> intelligentmixers HIGIJENSKE BATERIJE, USPONSKI TUŠEVI		Stranica: <b>504</b>
<b>SERIJA LANDQUART</b>		Stranica: <b>505</b>



<p><b>SERIJE VOLGA, TAJO, EBRO, SCARPE, DIVE</b></p>		<p>Stranica: <b>506</b></p>
<p><b>SERIJA TICINO</b></p>		<p>Stranica: <b>507</b></p>
<p><b>SERIJA ELBE</b></p>		<p>Stranica: <b>508</b></p>
<p><b>SERIJE THAMES LOIRE</b></p>		<p>Stranica: <b>509</b></p>
<p><b>KONZOLE, TUŠ RUČICE I CRIJEVA</b></p>		<p>Stranica: <b>510-512</b></p>
<p> SENZORSKE BATERIJE I INOX SANITARIJA</p>		<p>Stranica: <b>513-514</b></p>
<p> SERIJA EXPORT 2200</p>		<p>Stranica: <b>515-520</b></p>
<p> SERIJA HOTELLERIE</p>		<p>Stranica: <b>521-527</b></p>
<p> SERIJA TOUCH</p>		<p>Stranica: <b>528-530</b></p>
<p> SERIJA EGO 1300</p>		<p>Stranica: <b>531-533</b></p>
<p> SERIJA LOGIC 3300</p>		<p>Stranica: <b>534-536</b></p>

 <i>Pure Freude an Wasser</i> <b>SERIJA ESSENTIALS CUBE</b>		Stranica: <b>537-538</b>
 <i>Pure Freude an Wasser</i> <b>SERIJA ESSENTIALS</b>		Stranica: <b>539-540</b>
 <b>KUPAONSKI DRŽAČI I SL.</b>		Stranica: <b>541</b>
 <b>KUPAONSKI DRŽAČI I SL.</b>		Stranica: <b>542-545</b>
 <b>SERIJA OMEGA</b>		Stranica: <b>546-548</b>
 <b>SERIJA PLAZA</b>		Stranica: <b>549</b>
 <b>SERIJA RETRO</b>		Stranica: <b>550</b>
 <b>SERIJA NEO</b>		Stranica: <b>551-552</b>
 <b>SERIJA CYTRO I KOZMETIČKA OGLEDALA</b>		Stranica: <b>553</b>
 <b>HOTELSKA OPREMA, RUKOHVATI</b>		Stranica: <b>554-555</b>
 <b>OPREMA ZA OSOBE S POSEBNIM POTREBAMA</b>		Stranica: <b>556-559</b>

<b>SERIJA RENNE</b>		Stranica: <b>560-561</b>
<b>SERIJA TERESA</b>		Stranica: <b>562-563</b>
<b>SERIJA LILLY</b>		Stranica: <b>564-565</b>
<b>KUPAONSKI DRŽAČI, RUKOHVATI, OGLEDALA I SL.</b>		Stranica: <b>566-567</b>
 <b>RUBINETTERIE</b> IZLJEVI, KONZOLE, TUŠ RUČICE I SL.		Stranica: <b>568-572</b>
<b>Alca PLAST®</b> UGRADNI ELEMENTI		Stranica: <b>573-577</b>
 Pure Freude an Wasser UGRADNI ELEMENTI		Stranica: <b>578-591</b>
 UGRADNI ELEMENTI		Stranica: <b>592-597</b>
 UGRADNI ELEMENTI I PVC VODOKOTLIČI		Stranica: <b>598-601</b>
 VODOKOTLIČI		Stranica: <b>602</b>
 VODOKOTLIČI I OPREMA		Stranica: <b>603</b>

 <b>SIFONI I SLIVNICI</b>		Stranica: <b>604-613</b>
 <b>SIFONI, SLIVNICI, PLOVCI</b>		Stranica: <b>614-616</b>
<b>LOŽ METALPRES</b> <b>SIFONI, SLIVNICI I POŠTANSKI ORMARIĆI</b>		Stranica: <b>617-619</b>
 <b>SIFONI</b>		Stranica: <b>620</b>
 <b>SIFONI</b>		Stranica: <b>621-622</b>
 <b>SIFONI, SLIVNICI, PLOVCI</b>		Stranica: <b>623-624</b>
 <b>SIFONI, SLIVNICI, WC PRIKLJUČCI</b>		Stranica: <b>625</b>
<b>TREMOLADA</b> <b>BATERIJE, VENTILI I SL.</b>		Stranica: <b>626-627</b>
<b>Alca PLAST®</b> <b>TUŠ KANALICE, SIFONI, REŠETKE I SL.</b>		Stranica: <b>628-635</b>
 <b>VENTILI I SLAVINE</b>		Stranica: <b>636-637</b>
 <b>REDUKCIJE, PRODUŽETCI I SL.</b>		Stranica: <b>638-639</b>



 <p><b>REDUKCIJE, PRODUŽETCI I SL.</b></p>		<p>Stranica: <b>640-641</b></p>
 <p><b>REDUKCIJE, PRODUŽETCI I SL.</b></p>		<p>Stranica: <b>642-643</b></p>
 <p><b>FLEX-CIJEVI</b></p>		<p>Stranica: <b>644-647</b></p>
<p><b>RAZNO</b></p>		<p>Stranica: <b>648-654</b></p>
<p><b>KADE, TUŠ KADE I ČUČAVCI EMAJLI RANI I KERAMIČKI</b></p>		<p>Stranica: <b>655</b></p>
 <p><b>TIPLE, VIJCI, OSTALA OPREMA</b></p>		<p>Stranica: <b>656-658</b></p>
<p><b>SILIKONI, PUR PJENE, MONTAŽNA LJEPILA</b></p>		<p>Stranica: <b>659-663</b></p>
 <p><b>BOJLERI</b></p>		<p>Stranica: <b>664-665</b></p>

<p><b>gorenje</b></p> <p>BOJLERI</p>		<p>Stranica: <b>666-669</b></p>
<p><b>Termorad</b> WATER HEATERS Termorad Group</p> <p>BOJLERI I OPREMA</p>		<p>Stranica: <b>670-672</b></p>
<p><b>ARISTON</b></p> <p>BOJLERI</p>		<p>Stranica: <b>673-681</b></p>
<p><i>Windy</i></p> <p>PROFESIONALNA SUŠILA I OPREMA</p>		<p>Stranica: <b>682-683</b></p>
<p><b>VORTICE</b></p> <p>VENTILATORI</p>		<p>Stranica: <b>684</b></p>
<p><b>TELCON</b></p> <p>VENTILATORI ROZETNE, GRIJALICE ZA KUPATILO</p>		<p>Stranica: <b>685-686</b></p>
<p><b>VECAMCO</b></p> <p>REŠETKE, VENTILATORI I SL.</p>		<p>Stranica: <b>687-691</b></p>



**kolpa·san**<sup>®</sup>  
by kolpa



[www.kolpa.si](http://www.kolpa.si)

## Kupaonske kade – pregled po oblicima i dimenzijama

a x b	70	72	75	80			88	90			95	105
275		Symbiosis										
200								Rapido				
196												
192												
190								Elektra			Norma	
185								Rapido				
180				Aida	Soave			Vanessa	Libero			
				Armida	Adonis***							
				Carmen								
				Copelia								
				Destiny								
178							Siris-FS***					
170	Destiny		Aida	Carol**						Arabela		Grazia**
	Elektra		Carmen	Elektra								
	Tamia		Destiny	Valis								
			Elektra									
			Figaro									
160	Adela		Aida			Fidelio				Calando**		
150	Destiny		Elektra									
145	Tamia											
140	Valis											
130	Adela											
	Figaro											
	Tamia											
120	Accordo**											
110	Accordo											
100	Tamia											
	TamiaS**											
130	Ester											
120	Cavatina		Boogie*									
110												
100	Mini*											

**a x b** dimenzije u cm: oblik: materijal: akril  
 klasični kerrock  
 kutni polirock  
 ovalni  
 okrugli  
 asimetrični



## Kupaonske kade – pregled po oblicima i dimenzijama

a x b	110	117	120	130	140	145	150	160
275								
200								
196		Tristan*						
192								
190	Gloriana		Nabucco					
185								
180								Samson
178								
170		Beatrice Lulu**	Chad**					
160							Swan**	Vivo
150							Alba** Largo Loco**	
145						Piano**		
140					Allegro** Divante**			
130					Royal**			
120				Royal**				
110								
100								

\* kada bez obloge

\*\* kada s ugrađenim sjedištem

\*\*\* kada i obloga od jednoga komada

<p><b>Kupaonske kade</b> Rock line</p>	<p><b>Kupaonske kade</b></p>	 <p>ADONIS 180x80 FS</p>	 <p>PIANO 145x145 (PIANO 145/O)</p>
 <p>SYMBIOSIS PLUS 275x72 FS</p>	 <p>GLORIANA 190x110 (GLORIANA 190/O)</p>	 <p>EROICA 180x80 FS</p>	 <p>ALLEGRO 140x140 (ALLEGRO 140/O)</p>
 <p>SYMBIOSIS 275x72 FS</p>	 <p>COMODO 185x90 FS</p>	 <p>VIVO Ø 160 (VIVO 160/O)</p>	 <p>DIVANTE 140x140 (DIVANTE 140/O)</p>
 <p>SOAVE 180x80 FS</p>	 <p>OTHELLO 185x90 FS White OTHELLO 185x90 FS B&amp;W OTHELLO 185x90 OTHELLO BOX</p>	 <p>SWAN 160x160 (SWAN 160/O)</p>	 <p>ROYAL 130x130 (ROYAL 130/O) ROYAL 120x120 (ROYAL 120/O)</p>
 <p>COPELIA 180x80 FS</p>	 <p>LIBERO 180x90 (LIBERO 180/O)</p>	 <p>LARGO 150x150 (LARGO 150/O)</p>	 <p>CHAD-L 170x120 (CHAD 170/O)</p>
 <p>TRISTAN 196x117 FS</p>	 <p>SIRIS 178x88 FS</p>	 <p>ALBA 150x150 (ALBA 150/O)</p> <p>LOCO 150x150 (LOCO 150/O)</p>	 <p>CHAD-D 170x120 (CHAD 170/O)</p>
<p>www.kolpa.si</p>	 <p>SIRIS 178x88 FS</p>	 <p>LOCO 150x150 (LOCO 150/O)</p>	 <p>CHAD-D 170x120 (CHAD 170/O)</p>

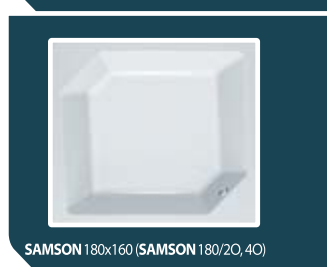
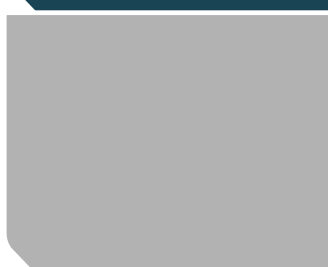
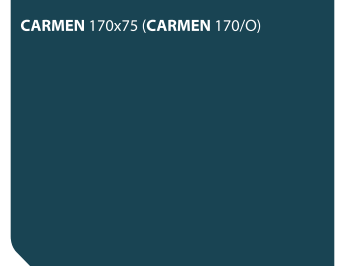



**DESTINY 180x80 (DESTINY 180/O)**  
**DESTINY 170x75 (DESTINY 170/O)**  
**DESTINY 170x70 (DESTINY 170/O)**  
**DESTINY 160x70 (DESTINY 160/O)**

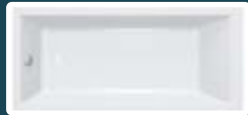

**FIGARO 170x75 (FIGARO 170/O)**  
**FIGARO 150x70 (FIGARO 150/O)**



**MINI 100x70**



**ADELA 160x70 (ADELA 160/O)**  
**ADELA 150x70 (ADELA 150/O)**

**Masažne kupaonske kade**



**VALIS 170x80 (VALIS 170/O)**  
**VALIS 160x70 (VALIS 160/O)**



**ACCORDO 140x70/S (ACCORDO 140/SO)**



**LILY 150x150 (LILY 150/O)**



**CAROL 170x80/S (CAROL 170/SO)**



**ACCORDO 140x70 (ACCORDO 140/O)**



**OPERA 180x180 (OPERA 180/O)**



**TAMIA 170x75 (TAMIA 170/O)**  
**TAMIA 170x70 (TAMIA 170/O)**  
**TAMIA 160x70 (TAMIA 160/O)**  
**TAMIA 150x70 (TAMIA 150/O)**  
**TAMIA 140x70 (TAMIA 140/O)**



**ESTER 130x70 (ESTER 130/O)**



**GAIA 160x160 (GAIA 160/O)**



**CAVATINA 120x70/S (CAVATINA 120/SO)**



**SAMSON 180x160 (SAMSON 180/O)**



**TAMIA 140x70/S (TAMIA 140/SO)**



**BOOGIE 120x75**



\* tuš kad bez obloge

\*\* kada sa sjedištem

## Tuš kade – pregled po oblicima i dimenzijama

a x b	70	75	80		90			100		
oblik	klasični	klasični	klasični	polukružni	asimetrični	klasični	polukružni	asimetrični	klasični	polukružni
180			Flamenco							
			Re-Walk							
170		Flamenco	Flamenco							
160	Flamenco					Flamenco				
						Salsa				
140			Flamenco			Bono*				
			Re-Walk			Canary				
						Flamenco				
						Salsa				
130						Flamenco				
	Flamenco		Canary			Canary		Malur		
			Flamenco			Flamenco				
			Haka			Haka				
			Salsa			Lerock Zero				
			Vals			Salsa				
						Step Zero				
						Vals				
110			Flamenco			Flamenco				
			Canary		Malur	Flamenco			Boston	Blues
100			Flamenco						Canary	Eisa
									Lerock Zero	Macarena
									Rock	
									Salsa	
									Step Zero	
90	Flamenco	Canary	Ska			Beat-IN	Bebop			
						Boston	Blues			
						Canary	Bossanova			
						Flamenco	Dixie**			
						Haka	Eisa			
						Horon**	Macarena			
						Rock	Ontex			
						Salsa	Pony			
						Trin				
					Vals					
80			Boston	Ontex						
			Rock	Pony						
			Trin							
70	Flamenco									

www.kolpa.si

a x b dimenzije u cm:

- oblik:
- klasični
  - polukružni
  - asimetrični

materijal:

- sanitarni akril
- kerrock
- ljevani mramor

**Tuš kade**  
Rock line



VIP 120x90



HAKA 120x90 (HAKA 120/O)  
HAKA 120x80 (HAKA 120/O)  
HAKA 90x90 (HAKA 90/O)

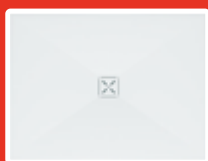

Rock line

LEROCK ZERO 120x90  
LEROCK ZERO 100x100  
LEROCK ZERO 120x90 CREPE  
LEROCK ZERO 100x100 CREPE



VALS 120x90 (VALS 120/O)  
VALS 120x80 (VALS 120/O)  
VALS 90x90 (VALS 90/O)

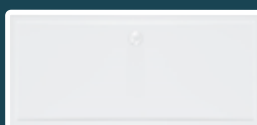

FLAMENCO 180x80 (FLAMENCO 180/O)  
FLAMENCO 170x80 (FLAMENCO 170/O)  
FLAMENCO 170x75 (FLAMENCO 170/O)  
FLAMENCO 160x90 (FLAMENCO 160/O)  
FLAMENCO 160x70 (FLAMENCO 160/O)  
FLAMENCO 140x90 (FLAMENCO 140/O)  
FLAMENCO 140x80 (FLAMENCO 140/O)  
FLAMENCO 130x90 (FLAMENCO 140/O)  
FLAMENCO 120x90 (FLAMENCO 120/O)  
FLAMENCO 120x80 (FLAMENCO 120/O)  
FLAMENCO 120x70 (FLAMENCO 120/O)  
FLAMENCO 110x90 (FLAMENCO 120/O)  
FLAMENCO 110x80 (FLAMENCO 120/O)  
FLAMENCO 100x90 (FLAMENCO 100/O)  
FLAMENCO 100x80 (FLAMENCO 100/O)  
FLAMENCO 90x90 (FLAMENCO 90/O)  
FLAMENCO 90x70 (FLAMENCO 90/O)  
FLAMENCO 70x70 (FLAMENCO 70/O)

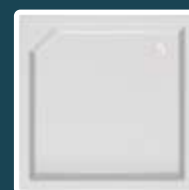

ROCK 100x100 (ROCK 100/O)  
ROCK 90x90 (ROCK 90/O)  
(ROCK 90/30)  
ROCK 80x80 (ROCK 80/O)  
(ROCK 80/30)

**Tuš kade**



RE-WALK 180x80  
RE-WALK 140x80



CANARY 140x90 (CANARY 140/O)  
CANARY 120x90 (CANARY 120/O)  
CANARY 120x80 (CANARY 120/O)  
CANARY 100x100 (CANARY 100/O)  
CANARY 100x80 (CANARY 100/O)  
CANARY 90x90 (CANARY 90/O)  
CANARY 90x75 (CANARY 90/O)



MACARENA 100x100 (MACARENA 100/O)  
MACARENA 90x90 (MACARENA 90/O)

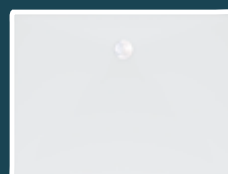

SALSA 160x90 (SALSA 160/O)  
SALSA 140x90 (SALSA 140/O)  
SALSA 120x90 (SALSA 120/O)  
SALSA 120x80 (SALSA 120/O)  
SALSA 100x100 (SALSA 100/O)  
SALSA 90x90 (SALSA 90/O)



STEP ZERO 120x90  
STEP ZERO 100x100

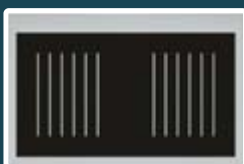

BONO 140 x90

[www.kolpa.si](http://www.kolpa.si)

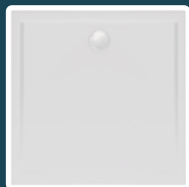

**BOSTON 100x100 (BOSTON 100/O)**

**BOSTON 90x90 (BOSTON 90/O)**

**BOSTON 80x80 (BOSTON 80/O)**



**TRIN 90x90 (TRIN 90/O)**

**TRIN 80x80 (TRIN 80/O)**



**EISA 100x100 (EISA 100/O)**

**EISA 90x90 (EISA 90/O)**



**DIXIE 90x90 (DIXIE 90/O)**



**BEBOP 90x90 (BEBOP 90/O)**



**BEAT-IN 90x90 (BEAT-IN 90/O)**



**MALUR-D 120x90 (MALUR 120/O)**

**MALUR-D 100x80 (MALUR 100/O)**



**BLUES 100x100 (BLUES 100/O)**

**BLUES 90x90 (BLUES 90/O)**

**(BLUES 90/30)**



**ONTEX 90x90 (ONTEX 90/O)**

**ONTEX 80x80 (ONTEX 80/O)**



**SKA 90x80 (SKA-L 90x80/O)**



**MALUR-L 120x90 (MALUR 120/O)**

**MALUR-L 100x80 (MALUR 100/O)**



**PONY 90x90 (PONY 90/O)**

**PONY 80x80 (PONY 80/O)**



**HORON 90 (HORON 90/O)**



**BOSSANOVA 90x90 (BOSSANOVA 90/O)**

[www.kolpa.si](http://www.kolpa.si)

## Tuš kabine – pregled po oblicima i dimenzijama

Postavljanje

program										
<b>Terra</b>										
	TKK	TKP	TV + TSv				TV/S			
<b>Terra flat</b>										
	TKK						TV/S			
<b>Corona</b>										
	TK	TS OPEN	TS OPEN + TS				TV/S	TK OPEN	TK OPEN + TS	PS
<b>Virgo</b>										
	TK						TV2D/S			
<b>Kronos</b>										
	TK						TV2D/S			
<b>Orion</b>										
	TKP/EN									
<b>Sole</b>										
							TV/S			
<b>Luna</b>										
							TVZ/S			
<b>Free line</b>										
	TKK	TV4D/S + TS					TV4D/S			
<b>Q line</b>										
	TKK	TKP	TV2D/S + TS	TV4D/S + TS	TKK HORON	TKP DIXIE	TV2D/S	TV4D/S	TVO/S	
<b>Quat</b>										
	TKK	TKP								

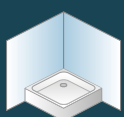

kutno postavljanje



postavljanje u niši



postavljanje uz zid



## Tuš kabine – pregled po oblicima i dimenzijama

Postavljanje

program										
Terra										
Terra flat										
Corona										
	TP GRAZIA									
Virgo										
Kronos										
Orion										
	TV/2D + TSv	TV/4D + TSv							TV/2D + U pr.	TV/4D + U pr.
Sole										
	TP 75/77	TP 112	TP BEATRICE	TP FIDELIO	TP CHAD	TP 102/123	TP 104	TP LOCO	TP ARABELA	
Luna										
Free line										
Q line										
Quat										
	TP 75	TP 110	TP 140	TP 105, 108						

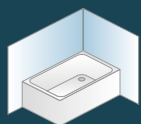

kutno postavljanje

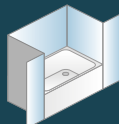

postavljanje u niši

Masažne kabine,  
masažni paneli,  
parne saune



MIGNON 128 -L, -D

Rock line



DIABLO 1700 3f



DIABLO 1550 2f



TV/S 90, 100 -L, -D

Terra



TV 90 + TSv 90, 80 -L, -D

Terra



TK OPEN 120 x 80, 120 x 90, 140 x 80,  
140 x 90 + TS OPEN 28

Corona



TS OPEN 90, 100, 120, 140

Corona



MELBA 100 M5, M6, M3Q



BORA 1420 3f



TKK 90, 100

Terra flat



TS OPEN 120, 140 + TS OPEN 28

Corona



NOTUS 2200 5f

Rock line



ARIA 90 QUAT A0, A3



TV/S 70, 80, 90

Terra flat

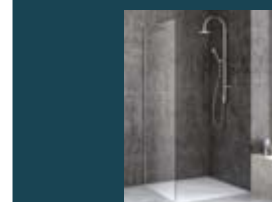

PS 72, 82

Corona



NOTUS 1400 5f

Rock line

Tuš kabine



TK 120x80, 120x90, 140x90 -L, -D

Corona



TP 92 GRAZIA -L, -D

Corona



ZONDA 1500 3f

Rock line



TKK 90, 100

Terra



TV/S 120, 130, 140 -L, -D

Corona



TK 120, 140, 160 -L, -D

Virgo



MISTRAL 1200 3f NEW

Rock line



TKP 90, 100

Terra



TK OPEN 120 x 80, 120 x 90,  
140 x 80, 140 x 90

Corona

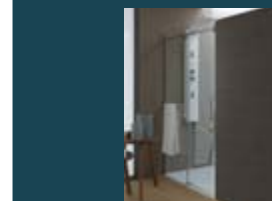

TV2D/S 120, 140, 160 -L, -D

Virgo

**Kronos**  
TK 120, 140, 160-L, -D

**Sole**  
TV/S 100, 130 -L, -D

**Sole**  
TP 102 CHAD -L, -D

**Free line**  
TV4D/S 120, 140, 160, 170

**Kronos**  
TV2D/S 120, 140, 160 -L, -D

**Sole**  
TP 75 -L, -D

**Sole**  
TP 104 -L, -D

**Free line**  
TV4D/S 120, 140, 160, 170  
+ TS 70, 75, 80, 90 NEW

**Orion**  
Orion TKP 80/EN

**Sole**  
TP 77 -L, -D

**Sole**  
TP 123 -L, -D

**Q line**  
TKK 70 x 70, 70 x 90, 75 x 90 80,  
80 x 90, 80 x 100, 90, 90 x 100, 100

**Orion**  
TV/2D 120, 130 + U profil

**Sole**  
TP 112-L, -D

**Sole**  
TP 143 LOCO -L, -D

**Q line**  
TKP 80, 80 x 100, 90,  
90 x 120, 100

**Orion**  
TV/2D 120, 130 + TSv 70, 75, 80

**Sole**  
TP 112 Beatrice -L, -D

**Sole**  
TP 80 ARABELA -L, -D

**Q line**  
TV2D/S 100, 110, 120, 130

**Orion**  
TV/4D 140, 150, 160, 170,  
180 + U profil

**Sole**  
TP 90 Fidelio -L, -D 129

**Luna**  
TVZ/S 80, 90

**Q line**  
TV2D/S 100, 110, 120, 130  
+ TS 70, 75, 80, 90 NEW

**Orion**  
TV/4D 140, 150, 160, 170,  
180 + TSv 70, 75, 80

**Sole**  
TP 102 -L, -D

**Free line**  
TKK 100

**Q line**  
TV4D/S 140, 160, 170



Q line

TV4D/S 140, 160, 170  
+ TS 70, 75, 80, 90 NEW

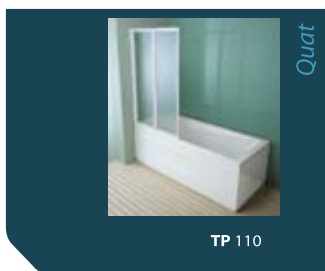

Quat

TP 110

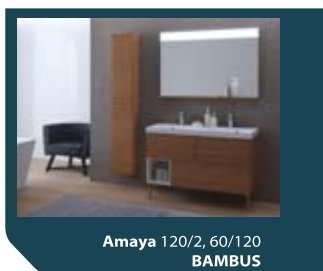

Amaya 120/2, 60/120  
BAMBUS

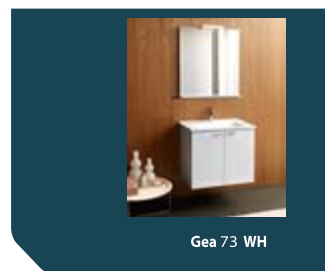

Gea 73 WH



Q line

TKK 90 HORON

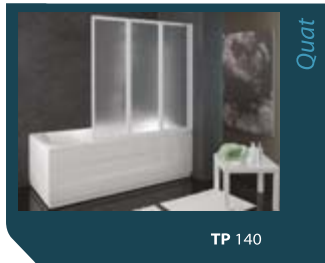

Quat

TP 140



Oxana 105, 80, 60  
WH, ACACIA, HACIENDA



Sara 82, 62  
TEX LIGHT, TEX DARK



Q line

TKP 90 DIXIE

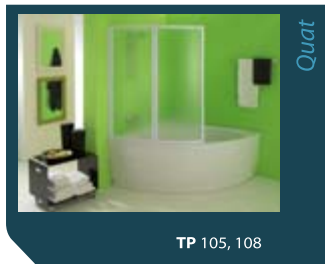

Quat

TP 105, 108

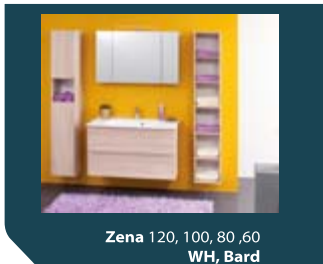

Zena 120, 100, 80, 60  
WH, Bard

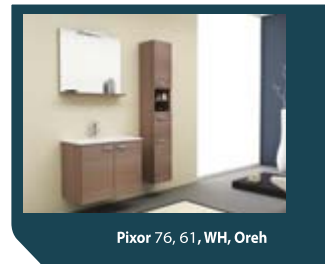

Pixor 76, 61, WH, Oreh

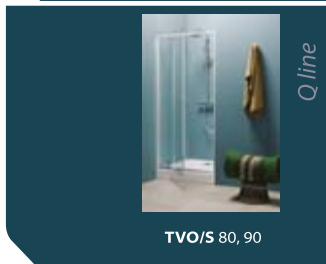

Q line

TVO/S 80, 90

## Kupaonski namještaj

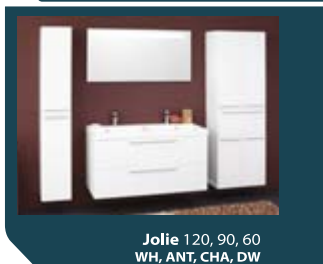

Jolie 120, 90, 60  
WH, ANT, CHA, DW



Pixor II 76, 61, WH, Oreh



Quat

TKK 80, 90



Nayra 120, 100  
WH, LAR, WENGE



Uma 90, 60  
WH, WH 3D



Demi 65 -L, -D  
WH, ACACIA

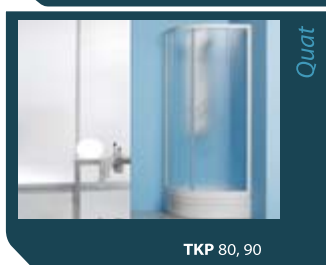

Quat

TKP 80, 90

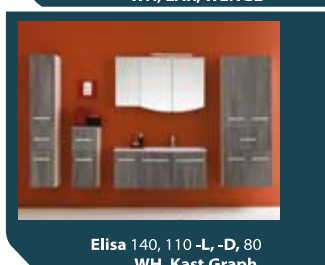

Elisa 140, 110 -L, -D, 80  
WH, Kast.Graph.



Viva 70, 60, 50 WH, RED,  
MANHATAN, KIWI, BEIGE



Kiki 40 WH, Wenge

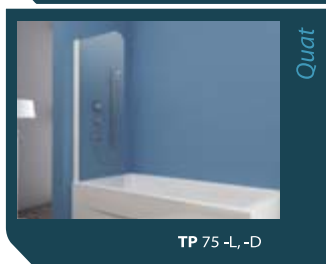

Quat

TP 75 -L, -D

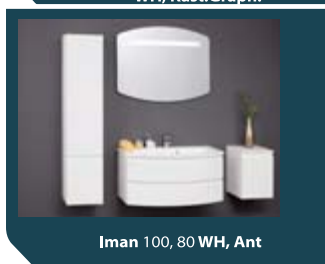

Iman 100, 80 WH, Ant

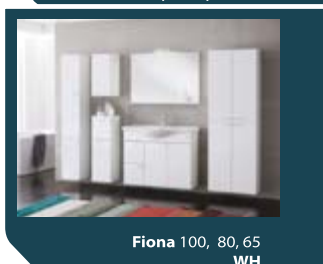

Fiona 100, 80, 65  
WH



Toaletni ormarić  
TOP 75



## Tehnologija i materijali

### Lijevani sanitarni akril



Kolpa d.d. ima više od 35 godina radnog iskustva u preradi sanitarnog lijevanog akrila, materijala iz kojega proizvodimo kade za kupanje i tuš kade.

Svojstva lijevanog sanitarnog akrila:

- najplemenitiji polimerni materijal
- trajan i ne stari
- Ugodan je na dodir
- Ima visok sjaj
- u brojnim bojama
- Otporan je na razrijeđene kiseline i lužine, alkohol, sredstva za dezinfekciju, izbjeljivače...
- Budući da je dobar toplinski izolator štedi energiju
- Obojen je po cijeloj debljini, što omogućava jednostavno saniranje mehaničkih oštećenja

### Polirock



Polirock je kompozitni materijal koji je više nego primjeren za kupaonice.

Odlikuju ga:

- prijatan osjećaj na dodir
- lakoća čišćenja
- jednaka struktura kroz cijelu debljinu
- otpornost na kemikalije i toplotu

Napravljen je od visokokvalitetnog aluminijum trihidrata i kvalitetne akrilno - poliestarske smole.

### Kerrock



Kerrock je kompozitni materijal koji je na tržištu već godinama poznat kao izdržljiv i vječni materijal. Sastoji se od aluminijeva hidroksida i polimernog veziva na akrilnoj bazi.

Odlikuju ga sljedeća svojstva :

- ugodnost na dodir
- lakoća čišćenja
- neporoznost
- jednaka struktura cijelom debljinu
- otpornost na kemikalije i na mehanička oštećenja
- negorivost

U programu Kolpa-san od njega izrađujemo kupaonske kade, tuš kade i umivaonike za kupaonski namještaj.

### Lijevani mramor

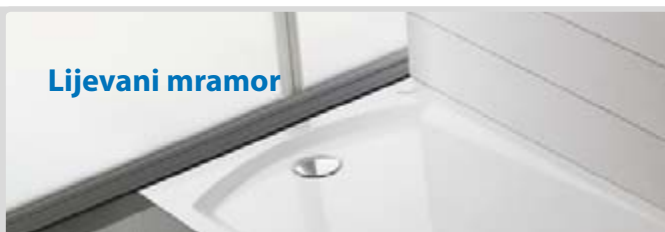

Proizvodi od lijevanog mramora već su više godina prisutni na tržištu jer udovoljavaju vrlo visokim kriterijima dizajna, estetike i otpornosti.

Odlikuje ih:

- glatka sjajna površina,
- lakoća čišćenja,
- dugi vijek trajanja,
- jednostavnost ugradnje
- otpornost na kemikalije

U programu Kolpa-san od njega izrađujemo tuš kade i umivaonike za kupaonski namještaj. Sastoje se od površinskog sloja od obojene visokokvalitetne poliesterske smole i središnjeg dijela od poliesterskoga betona - 80% kalcita i poliesterske smole.

## Tuš kabine posebnih dimenzija



Mogućnost prilagodbe visine



Mogućnost prilagodbe širine



Mogućnost prilagođavanja nagibnog kuta



Mogućnost prilagođavanja oblika



Mogućnost odabira boje profila

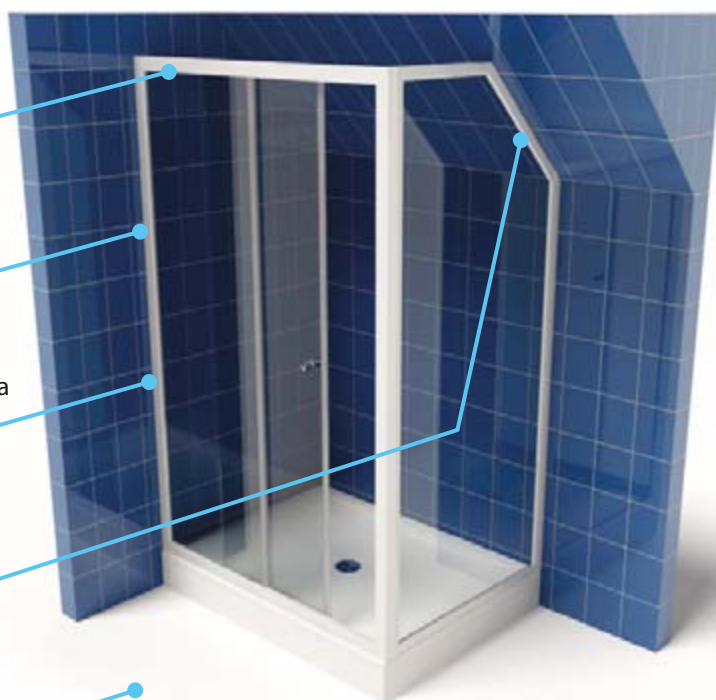

## Dodatni profili za tuš kabine

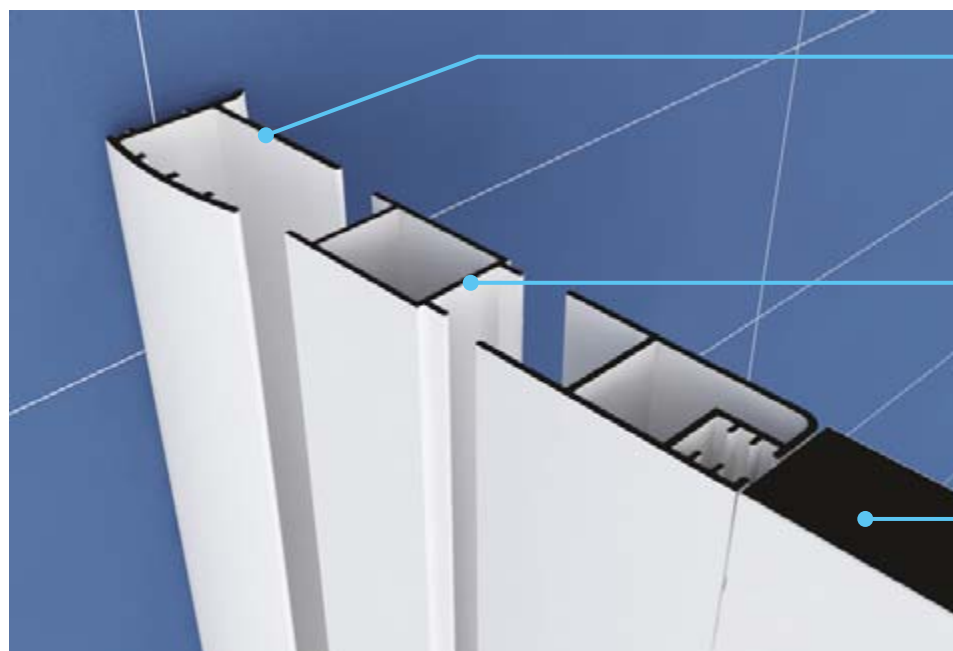

Zidni profil

Dodatni kompenzacijski profil

Tuš vrata



## Vrste stakala i profila kod tuš kabina



Nudimo Vam rješenje za svaki ukus!

Pogledajte mogućnosti izbora između različitih kombinacija stakla i profila koje nudimo u našim programima na sljedećoj stranici.



**Silver Brill profili**  
(visokopolirana srebrna galvanska prevlaka)



**Silver profili**  
(polirana srebrna galvanska prevlaka)



**Bijeli profili**  
(plastificiranje)



Kaljeno prozirno staklo

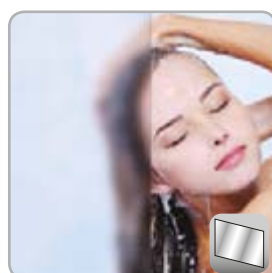

Kaljeno satinirano staklo

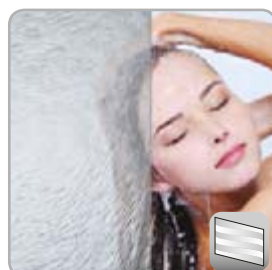

Kaljeno chincilla staklo

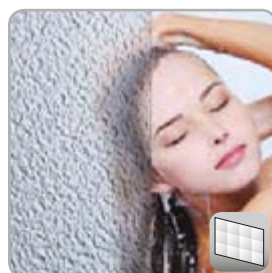

Kaljeno ornament staklo

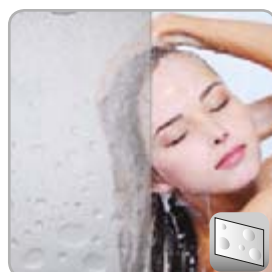

Polistirensko staklo Quat

## Tablica stakla i profila po programima

<b>Terra</b>												
TKK		•										•
TKP		•										•
TV/S		•										•
TV, TSv		•										•
<b>Terra flat</b>												
TKK		•										•
TV/S		•										•
<b>Corona</b>												
TK		•										•
TK OPEN		•										•
TS OPEN		•										•
TV/S		•										•
TP GRAZIA		•										•
PS		•										•
<b>Virgo</b>												
TK		•										•
TV/2D/S		•										•
<b>Kronos</b>												
TK		•										•
TV/2D/S		•										•
<b>Orion</b>												
TKP/EN				•	•						•	
TV/2D	•		•		•	•					•	
TV/4D	•		•		•	•					•	
TSv	•		•		•	•					•	
<b>Sole</b>												
TV/S			•									•
TP 75	•		•									•
TP 77	•											•
TP 112	•	•			•		•	•	•			•
TP Beatrice, TP Fidelio		•										•
TP Arabela	•											•
TP 102, 104, 123, 143		•										•
<b>Luna</b>												
TVZ/S			•		•						•	
<b>Free line</b>												
TKK			•									•
TV4D/S			•									•
TS			•									•
<b>Q line</b>												
TKK	•		•		•	•					•	
TKP	•		•		•	•					•	
TV2D/S, TV4D/S, TS	•		•		•	•					•	
TKP Dixie					•	•					•	
TKK Horon					•	•					•	
TVO/S			•		•						•	
<b>Quat</b>												
TKP	•			•							•	
TKK	•			•							•	
TP 75	•											•
TP 110, 140								•				•
TP 108, 105								•				•

## Zaštita od prskanja vode kod tuš zaslona

### Unatoč brtvilima na tuš kabini voda još uvijek otječe. Je li normalno?

Tuš kabine nude različite stupnjeve brtvljenja, ali potpunu zaštitu od otjecanja vode nije moguće osigurati.



**F 1**

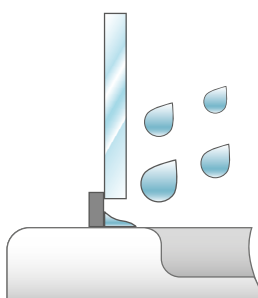

#### Kabine s donjim okvirom

Čimbenik 1

Modeli tuš kabina u izvedbi s aluminijskim okvirom

Ti modeli omogućuju posebno dobra vodonepropusna svojstva.

Preporučuju se za tuširanja s većom frekvencijom i uporabom masažnih tuševa s velikom količinom vode.



**F 2**

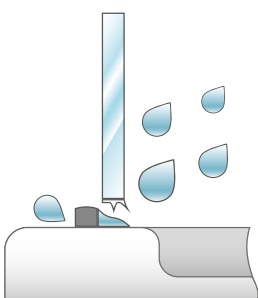

#### Dodatni zaštitni profil

Čimbenik 2

Modeli tuš kabina s dodatnim zaštitnim profilom

Dodatno postavljen profil poboljšava stupanj zaštite vodonepropusnosti, ali ju ne može 100% osigurati.



**F 3**

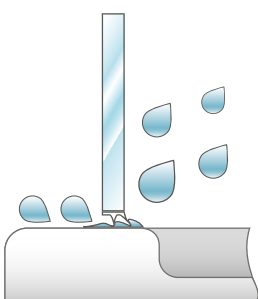

#### Kabine bez okvira

Čimbenik 3

Modeli tuš kabina u izvedbi bez aluminijskog okvira

Imaju zadovoljavajući stupanj zaštite u smislu vodonepropusnosti. Zbog manjkajućega donjeg okvira voda ima mogućnost lakšega istjecanja/curenja. Unatoč tomu ti su modeli kabina elegantni, ekskluzivni i omogućuju lakše čišćenje.

Dizajni tuš zaslona određuju stupanj vodonepropusnosti. Osnovno je pravilo: što je veći i viši donji profil, toliko je viši stupanj zaštite.

## Legenda

	Ulazni otvor		Polumjer		Boja profila		Srebrna brill
	Širina – dužina		Visina		Bijela		Srebrna
	Ugradbena mjera						Vrste stakla
	Ugradbena mjera na tuš kadu		D Dužina		VM Minimalna ugradbena mjera		
	Ugradbena mjera na pod (pločice)		Š Širina				

	Mogućnost ugradnje tuš kabine		Mogućnost ugradnje sistema za masažu		
	Mogućnost ugradnje pipe s tušom		Mogućnost postavljanja kade samostojeću u prostor		
	Masažni paneli		Kromoterapija		Radio
	Nasloni za glavu				
	Kupaonska sjedala		Dužina, Širina, Visina		Stepenica
	Sredstva za čišćenje, dezinfekcijska sredstva, premazi				
	Mogućnost montaže na sve klasične kade				
	Mogućnost montaže na klasične kade širina 70-80 cm				
	Mogućnost montaže na klasične kade dužine 120-130 cm				
	Mogućnost montaže na klasične kade dužine 120-190 cm				
	Mogućnost montaže na klasične kade dužine 140-180 cm				
	Mogućnost montaže na slijedeće tuš kade				

		Kaljeno prozirno staklo
		Kaljeno chincilla staklo
		Kaljeno ornament staklo
		Polistirensko staklo Quat
		Kaljeno satinirano staklo

	Čimbenici vodonepropusnosti tuš kabina po modelima
	Kabine s donjim okvirom
	Dodatni zaštitni profil
	Kabine bez okvira

**LED:** LED svjetlo  
**NEON:** Neonsko svjetlo  
**HAL:** Halogeno svjetlo  
**E14:** obično svjetlo  
**T:** svjetlo s senzorskim prekidačem ili na dodir  
**SW:** svjetlo s prekidačem  
**S:** utičnica  
**C:** sat

svjetlo

**A++ A+ A C** energetski razred

tiho zatvaranje ladice

tiho zatvaranje vrata

push zatvaranje ladice

push zatvaranje vrata



# Kupaonske kade



[www.kolpa.si](http://www.kolpa.si)

## Masažni sistemi u kupaonskim kadama

	Vodeni masažni sistem I. PNEUMATSKI	Vodeni masažni sistem II. ELEKTRONSKI	Vodeni masažni sistem III. PNEUMATSKI	Vodeni i zračni masažni sistem ELEKTRONSKI	Zračni masažni sistem ELEKTRONSKI	Vital masažni sistem ELEKTRONSKI	Opcija za masažni sistem VODENE MIKRO-MLAZNICE
Gloriana 190	•	•			•		•
Gloriana 190/O	•	•			•		•
Comodo 185 FS						•	
Othello 185	•	•			•		•
Othello 185 FS						•	
Libero 180	•	•			•		•
Libero 180/O	•	•			•		•
Siris 178 FS						•	
Adonis 180 FS						•	
Eroica 180 FS						•	
Vivo 160	•	•					•
Vivo 160/O	•	•					•
Swan 160		•					•
Swan 160/O		•					•
Largo 150	•	•			•		•
Largo 150/O	•	•			•		•
Alba 150	•	•			•		•
Alba 150/O	•	•			•		•
Loco 150	•	•			•		•
Loco 150/O	•	•			•		•
Piano 145	•	•			•		•
Piano 145/O	•	•			•		•
Allegro 140	•	•			•		•
Allegro 140/O	•	•			•		•
Divante 140				•			
Divante 140/O				•			
Royal 130	•	•			•		
Royal 130/O	•	•			•		
Chad 170	•	•			•		•
Chad 170/O	•	•			•		•
Lulu 170	•	•			•		•
Lulu 170/O	•	•			•		•



## Masažni sistemi u kupaonskim kadama

	Vodeni masažni sistem I. PNEUMATSKI	Vodeni masažni sistem II. ELEKTRONSKI	Vodeni masažni sistem III. PNEUMATSKI	Vodeni i zračni masažni sistem ELEKTRONSKI	Vital masažni sistem ELEKTRONSKI	Luxus+ masažni sistem ELEKTRONSKI	Opcija za masažni sistem VODENE MIKRO-MLAZNICE
Beatrice 170	•	•			•		•
Beatrice 170/O	•	•			•	•	•
Grazia 170	•	•					•
Grazia 170/O	•	•					•
Arabela 170	•				•		
Arabela 170/O	•				•		
Calando 160	•	•			•		•
Calando 160/O	•	•			•		•
Fidelio 160	•	•					
Fidelio 160/O	•	•					
Rapido 200, Rapido 190	•	•			•		•
Rapido 200/O, Rapido 190/O	•	•			•	•	•
Nabucco 190	•	•			•	•	•
Nabucco 190/O	•	•			•	•	•
Norma 190	•	•			•	•	•
Norma 190/O	•	•			•	•	•
Elektra 190, Elektra 180, Elektra 170x75, Elektra 160	•	•			•		•
Elektra 190/O, Elektra 180/O, Elektra 170x75/O, Elektra 160/O	•	•			•	•	•
Samson 180					•		•
Samson 180/O					•		•
Vanessa 180	•	•			•		•
Vanessa 180/O	•	•			•	•	•
Armida 180	•	•			•		•
Armida 180/O	•	•			•	•	•
Aida 180, Aida 170	•	•			•		•
Aida 180/O, Aida 170/O	•	•			•	•	•
Carmen 180, Carmen 170	•	•			•		•
Carmen 180/O, Carmen 170/O	•	•			•	•	•
Destiny 180, Destiny 170, Destiny 160				•			
Destiny 180/O, Destiny 170/O, Destiny 160/O				•			
Valis 170, Valis 160	•	•			•		•
Valis 170/O, Valis 160/O	•	•			•		•
Tamia 170x75				•			
Tamia 170x75/O				•			

## Vodeni masažni sistem

Vodeni masažni sistem djeluje na taj način da crpka za vodu stvara pritisak i protok vode kroz masažne mlaznice. Mlaznice umjeravaju mlaz vode izmiješane sa zrakom. Tisuće zračnih mjehurića nošenih velikom brzinom vode intenzivno masira tijelo. Regulacijom dotoka zraka u masažu mlaznicu regulira se snaga masažnoga mlaza.



### Vodeni masažni sistem I. (pneumatski)



Vodeni masažni sistem I. (pneumatski)

#### Funkcije sistema:

- \* ● crpka za vodu
- \* ● 6 mlaznica za vodu
- \* ● pneumatski prekidač
- \* ● regulator protoka zraka min-max
- \* ● odvodno-preljevna garnitura
- \* ● podnožje kade za kupanje
- ○ 6 vodenih mikro-mlaznica s preklopnikom i jačom vodenom crpkom (za masažu leđa)
- ○ 2 dodatne vodene mikro-mlaznice (za masažu stopala)
- \* ○ obloga kadi za kupanje (za određene modele)

○ OPCIJE ZA ODREĐENE MODELE KUPAONSKIH KADA:

\* važi i za Vodeni masažni sistem III



## Vodeni masažni sistem II. (elektronski)



### Funkcije sistema:

- crpka za vodu
- 6 super mlaznica za vodu
- elektronski prekidač
- senzor za nivo vode
- odvodno-preljevna garnitura
- postolje kade za kupanje
- 6 vodenih mikro-mlaznica s preklopnikom i jačom vodenom crpkom (za masažu leđa)
- 2 dodatne vodene mikro-mlaznice (za masažu stopala)
- obloga kadi za kupanje (za određene modele)



○ OPCIJE ZA ODREĐENE MODELE KUPAONSKIH KADA:



## Vodeni i zračni masažni sistem

U taj su sistem ugrađeni svi elementi vodenog i zračnog masažnog sistema. Sinergija učinaka obaju sistema intenzivno djeluje na ljudski organizam, regenerira ga i opušta. Zračni masažni sistem djeluje na taj način da zračna crpka stvara protok komprimiranog zraka kroz zračne mlaznice. Mlaznice razbijaju zrak u sitne zračne mjehuriće, koji se miješaju s vodom te svojom kinetičkom energijom intenzivno masiraju tijelo.



### Vodeni i zračni masažni sistem (elektronski)



#### Funkcije sistema:

- zračna crpka
- vodena crpka
- 6 vodenih mlaznica
- 10 - 12 zračnih mlaznica
- elektronički prekidač za vodenu i zračnu crpku
- elektronička regulacija broja okretaja zračne crpke
- senzor za nivo vode
- odljevno-preljevna garnitura
- postolje kade za kupanje
- super vodene mlaznice
- 6 vodenih mikro-mlaznica s preklopnikom i jačom vodenom crpkom (za masažu leđa)
- 2 dodatne vodene mikro-mlaznice (za masažu stopala)
- obloga kadi za kupanje (za određene modele)



○ OPCIJE ZA ODREĐENE MODELE KUPAONSKIH KADA:



## Zračni masažni sistem (FS)



### Funkcije sistema:

- zračna crpka
- 10-11 zračnih mlaznica
- elektronički prekidač za zračnu crpku
- senzor za nivo vode
- odljevno-preljevna garnitura
- podnožje kade za kupanje
- obloga kade za kupanje



## Vital masažni sistem

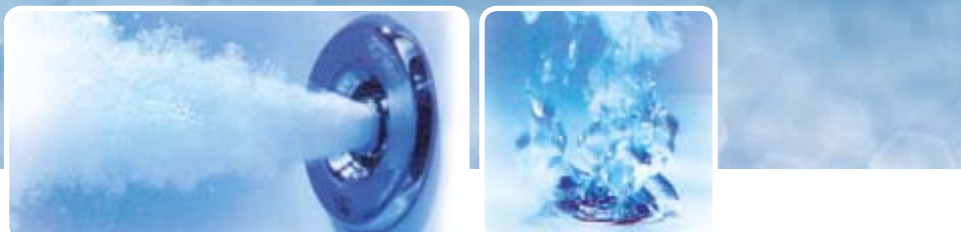

### Funkcije sistema:

- zračna crpka
- vodena crpka
- 6 super vodenih mlaznica
- 10 - 12 zračnih mlaznica
- 2 dodatne vodene mikro-mlaznice
- 6 vodenih mikro-mlaznica s preklopnikom
- regulator protoka zraka min-max
- elektronički prekidač za vodenu i zračnu crpku
- senzor za nivo vode
- svjetlo s chromoterapijo
- ozon
- intervalna regulacija za vodu
- oscilirajuća regulacija za zrak
- grijač za održavanje temperature vode
- programiranje željene temperature vode
- odljevno-preljevna garnitura
- podnožje kade za kupanje
- obloga kade za kupanje (za određene modele)



○ OPCIJE:



## Luxus + masažni sistem

Samo za kupaonsku kadu SAMSON i GAIA



### Funkcije sistema:

- vodna crpka
- zračna crpka
- elektronički prekidač za vodenu i zračnu crpku, svjetlo, chromoterapijo, filtriranje i grijanje vode
- grijač za održavanje temperature vode
- 2x regulatora protoka zraka min-max
- programiranje željene temperature vode
- ugrađen filter za filtraciju vode
- svjetlo s chromoterapijom
- senzor za razinu vode
- 7-8 mikro vodenih mlaznica
- 10-12 zračnih mlaznica
- 8 vodnih super mlaznica
- 2 prekidača za mikro-mlaznice
- odlivno prelivna garnitura
- podnožje kade za kupanje
- obloga masažne kade



- OPCJE:



## SYMBIOSIS 275 x 72 PLUS FS



### Symbiosis PLUS 275 FS

Samostojeća kupaonska kada od Kerrocka s integriranim umivaonikom i armaturom, bežičnim BLUETOOTH zvučnikom, jednoručnom armaturom s deflektorom za punjenje kade preko preljeva ili tuš ručice i odljevno prelivnom garniturom. Regulacija Bluetooth sustava preko kvadratne tipkovnice uz rub kade.

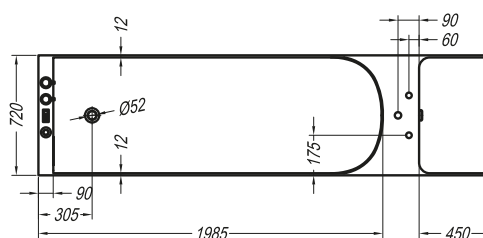
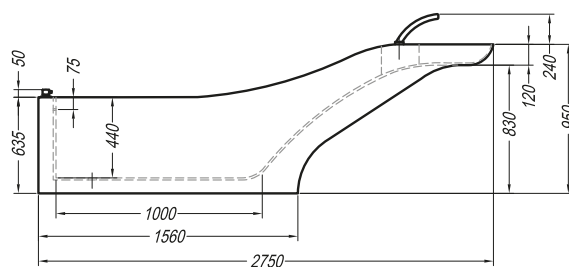



**SYMBIOSIS 275 x 72 FS**

Š. Vokel	D	Š	VM	Vol.
Symbiosis 275 x 72 FS	2750	720	950(635)	230 l



**Symbiosis 275 FS**

Samostojeća kupaonska kada od Kerrocka s integriranim umivaonikom i armaturom, odljevno preljevnom garniturom i bežičnim BLUETOOTH zvučnikom. Regulacija Bluetooth sustava preko kvadratne tipkovnice uz rub kade.

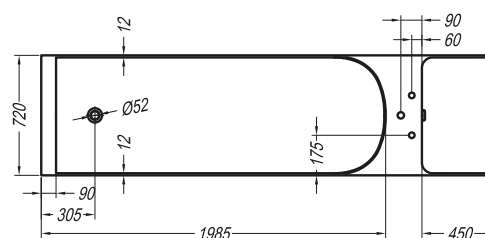
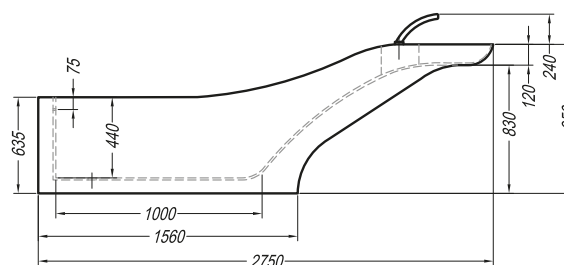



### Symbiosis 275 x 72 FS

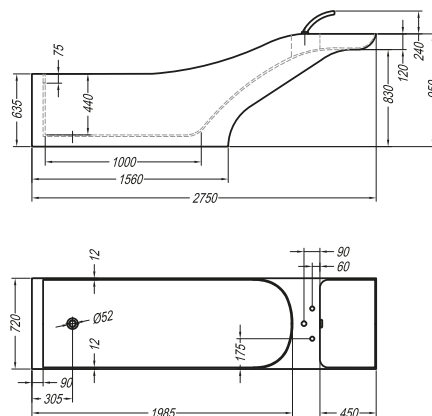

	D	Š	VM	Vol.
Symbiosis 275 x 72 FS	2750	720	950(635)	230 l
<b>Š.Vokel</b>	<b>Opis</b>			
	KADA SYMBIOSIS 275x72 FS BIJELA			



### Symbiosis PLUS 275 x 72 FS

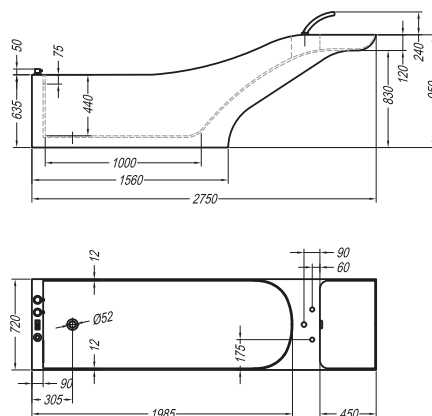

	D	Š	VM	Vol.
Symbiosis PLUS 275 x 72 FS	2750	720	950(635)	230 l
<b>Š.Vokel</b>	<b>Opis</b>			
	KADA SYMBIOSIS PLUS 275x72 FS BIJELA			



### Soave 180 x 80 FS

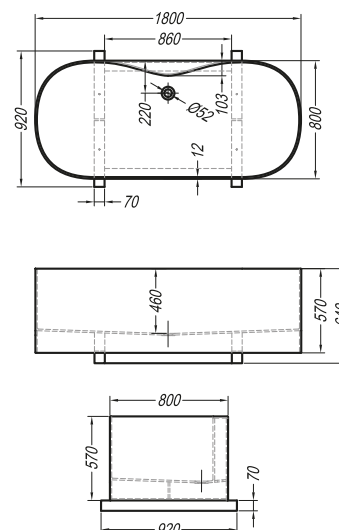

	D	Š	VM	Vol.
Soave 180 x 80 FS	1800	800	640	415 l
<b>Š.Vokel</b>	<b>Opis</b>			
<b>0401387</b>	KADA SOAVE 180x80 FS BIJELA KERROCK			







**Copelia 180 × 80 FS**

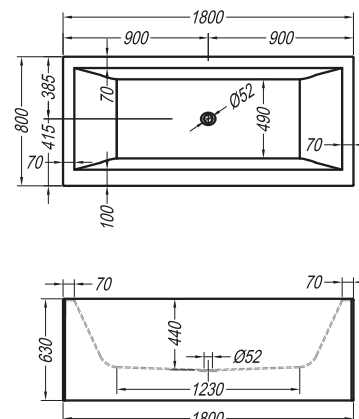

	D	Š	VM	Vol.
<b>Copelia 180 × 80 FS</b>	1800	800	630	245 l
<b>Š.Vokel</b>	<b>Opis</b>			
<b>0401373</b>	<b>KADA COPELIA 180x80 FS BIJELA</b>			



**Tristan 198 × 118 FS**

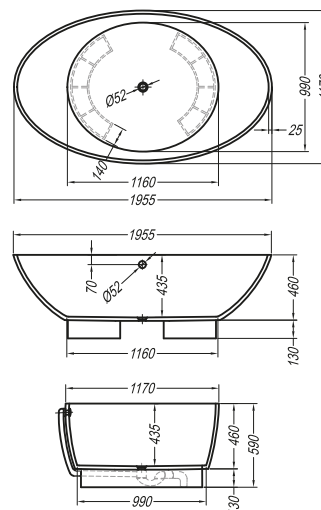

	D	Š	VM	Vol.
<b>Tristan 198 × 118 FS</b>	1960	1170	590	470 l
<b>Š.Vokel</b>	<b>Opis</b>			
<b>0401270</b>	<b>KADA TRISTAN 198x118 FS BIJELA POLIROCK</b>			





**Gloriana 190 × 110**

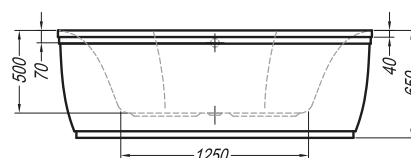
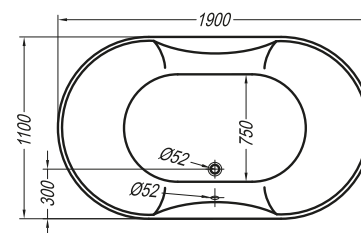

		D	Š	VM	Vol.
▪ Gloriana 190 × 110		1900	1100	650	345 l
▪ ▪ Gloriana 190 × 110 / O		1900	1100	650	345 l
Š.Vokel	Opis				
66113	KADA GLORIANA 190x110 BIJELA				
06242	KADA GLORIANA 190x110 S OBLOGOM BIJELA				



**Comodo 185 × 90 FS**

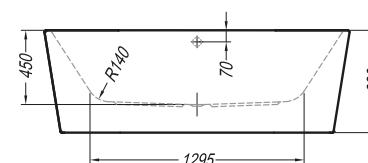
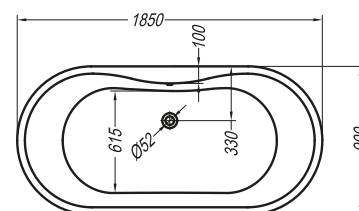

		D	Š	VM	Vol.
▪ ▪ ▪ Comodo 185 × 90 FS		1850	900	630	285 l
Š.Vokel	Opis				
0401389	KADA COMODO 185x90 FS BIJELA				



**Libero 180 × 90**

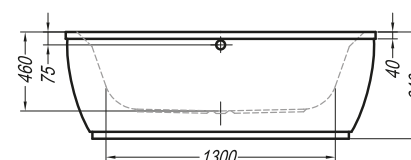
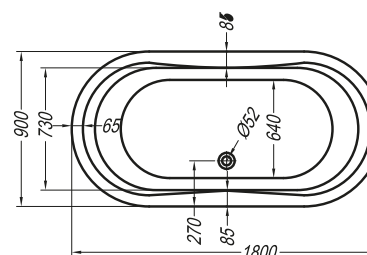

		D	Š	VM	Vol.
▪ ▪ Libero 180 × 90		1800	900	640	285 l
▪ ▪ Libero 180 × 90 / O		1800	900	640	285 l
Š.Vokel	Opis				
0401338	KADA LIBERO 180x90 BIJELA				
0401281	KADA LIBERO 180x90 S OBLOGOM BIJELA				





**Othello 185 × 90 FS white**

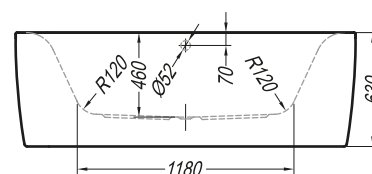
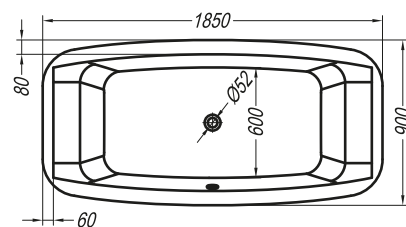

			D	Š	VM	Vol.	
▪	▪	▪	Othello 185 × 90 FS white	1850	900	630	275 l
<b>Š.Vokel</b>	<b>Opis</b>						
<b>0401369</b>	<b>KADA OTHELLO 185x90 FS S OBLOGOM BIJELA</b>						



**Othello 185 × 90 FS black & white**

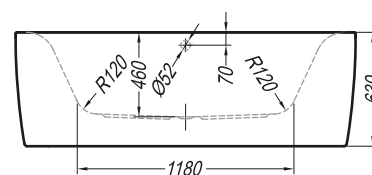
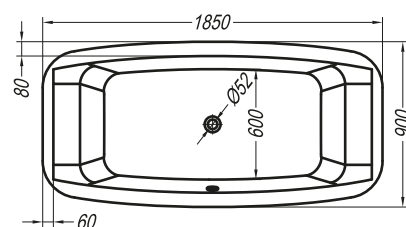

			D	Š	VM	Vol.	
▪	▪	▪	Othello 185 × 90 FS black & white	1850	900	630	275 l
<b>Š.Vokel</b>	<b>Opis</b>						
<b>0401367</b>	<b>KADA OTHELLO 185x90 FS S OBLOGOM CRNO/BIJELO</b>						



**Othello 185 × 90 BOX**

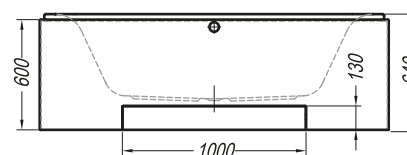
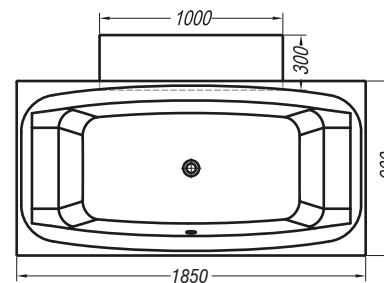

			D	Š	VM	Vol.	
▪			Othello BOX	1850	900	640	/
<b>Š.Vokel</b>	<b>Opis</b>						
	<b>KADA OTHELLO BOX 185x90 CRNO/BIJELO</b>						

Opcije:



Mogućnost ugradnje tuš kabine



Mogućnost ugradnje sistema za masažu



Mogućnost ugradnje pipe s tušem



Mogućnost postavljanja kade samostalno u prostor



**Siris 178 × 88 FS**

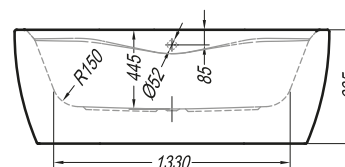
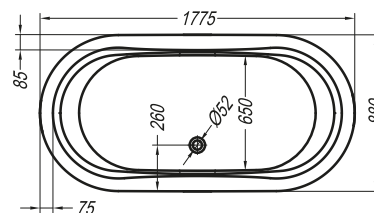

		D	Š	VM	Vol.
		1780	880	635	285 l
<b>Š.Vokel</b>	<b>Opis</b>				
<b>0401372</b>	<b>KADA SIRIS 178x88 FS S OBLOGOM BIJELA</b>				



**Adonis 180 × 80 FS**

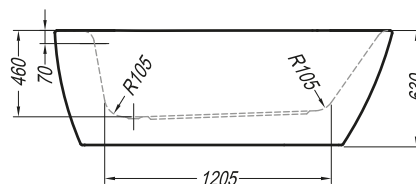
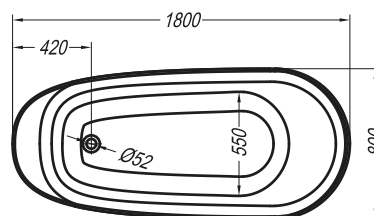

		D	Š	VM	Vol.
		1800	800	630	235 l
<b>Š.Vokel</b>	<b>Opis</b>				
<b>0401380</b>	<b>KADA ADONIS 180x80 FS S OBLOGOM BIJELA</b>				



**Eroica 180 × 80 FS**

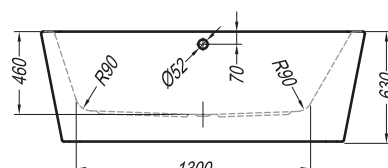
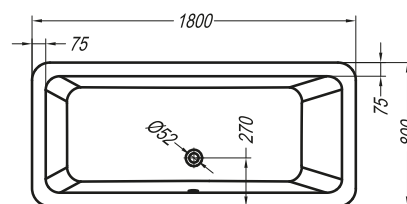

		D	Š	VM	Vol.
		1800	800	630	275 l
<b>Š.Vokel</b>	<b>Opis</b>				
	<b>KADA EROICA 180x80 FS S OBLOGOM BIJELA</b>				







		D	Š	VM	Vol.
▪	Vivo Ø 160	1600	1600	670	460 l
▪	Vivo Ø 160 / O	1600	1600	670	460 l

Š.Vokel	Opis
0401364	KADA VIVO Ø 160 BIJELA
0401363	KADA VIVO Ø 160 S OBLOGOM BIJELA

### Vivo Ø 160

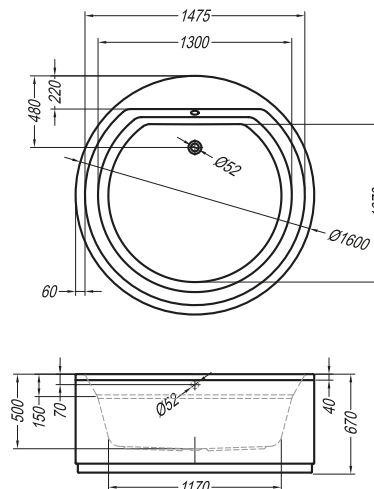

		D	Š	VM	Vol.
▪	Swan 160 x 160	1600	1600	670	340 l
▪	Swan 160 x 160 / O	1600	1600	670	340 l

Š.Vokel	Opis
0401375	KADA SWAN 160x160 BIJELA
0401368	KADA SWAN 160x160 S OBLOGOM BIJELA

### Swan 160 x 160

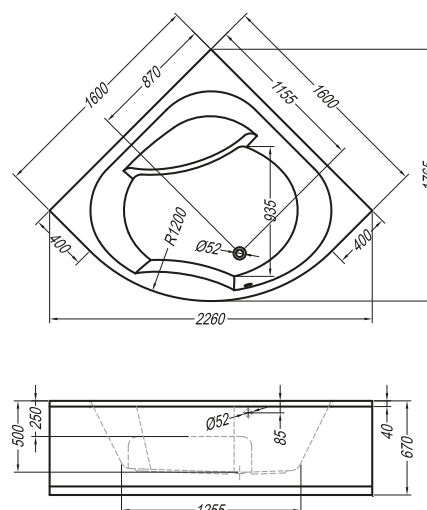

		D	Š	VM	Vol.
▪	Largo 150 x 150	1500	1500	640	310 l
▪	Largo 150 x 150 / O	1500	1500	640	310 l

Š.Vokel	Opis
0401293	KADA LARGO 150x150 BIJELA
0402074	OBLOGA ZA LARGO, ALBA 150
0402068	PODNOŽJE ZA KADE CK 120-150

### Largo 150 x 150

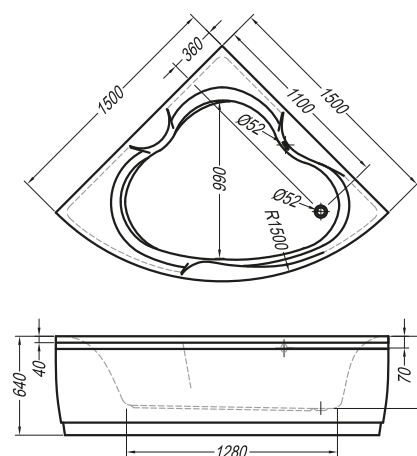

Opcije:



Mogućnost ugradnje tuš kabine



Mogućnost ugradnje sistema za masažu



Mogućnost ugradnje pipe s tušem



Mogućnost postavljanja kade samostalno u prostor



		D	Š	VM	Vol.
▪	Alba 150 × 150	1500	1500	640	280 l
▪	Alba 150 × 150 / O	1500	1500	640	280 l
Š.Vokel	Opis				
0401294	KADA ALBA 150x150 BIJELA				
0402074	OBLOGA ZA LARGO, ALBA 150				
0402068	PODNOŽJE ZA KADE CK 120-150				

### Alba 150 × 150

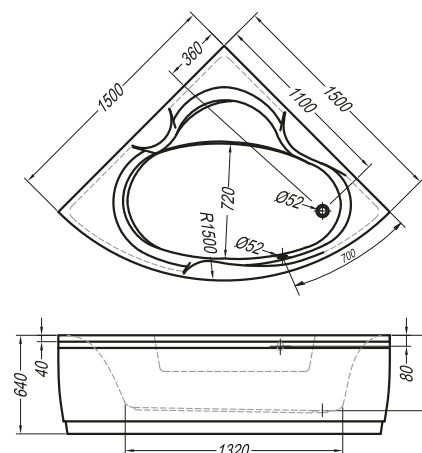

		D	Š	VM	Vol.
▪	Loco 150 × 150	1500	1500	680	385 l
▪	Loco 150 × 150 / O	1500	1500	680	385 l
Š.Vokel	Opis				
0401307	KADA LOCO 150x150 BIJELA				
0402077	OBLOGA LOCO 150 BIJELA				
0402068	PODNOŽJE ZA KADE CK 120-150				

### Loco 150 × 150

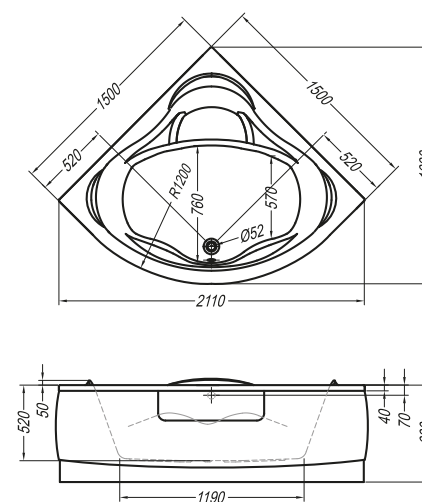

		D	Š	VM	Vol.
▪	Piano 145 × 145	1450	1450	610	210 l
▪	Piano 145 × 145 / O	1450	1450	610	210 l
Š.Vokel	Opis				
0401291	KADA PIANO 145x145 BIJELA				
0402067	OBLOGA PIANO 145 BIJELA				
0402068	PODNOŽJE ZA KADE CK 120-150				

### Piano 145 × 145

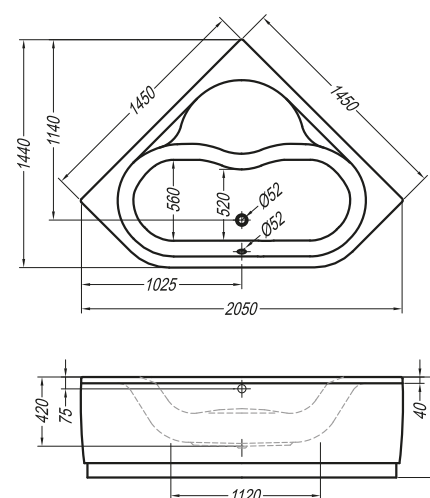



### Allegro 140 × 140

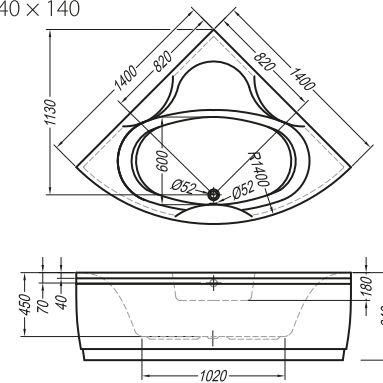

Š.Vokel	Opis
0401295	KADA ALLEGRO 140x140 BIJELA
0402075	OBLOGA ALLEGRO 140 BIJELA
0402068	PODNOŽJE ZA KADE CK 120-150

	D	Š	VM	Vol.
▪ ▪ Allegro 140 × 140	1400	1400	640	230 l
▪ ▪ ▪ Allegro 140 × 140 / O	1400	1400	640	230 l



### Divante 140 × 140

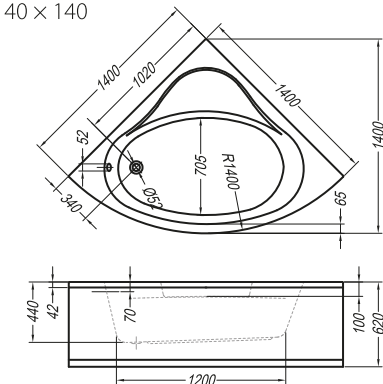

Š.Vokel	Opis
0401346	KADA DIVANTE 140x140 BIJELA
0402106	OBLOGA DIVANTE 140 BIJELA
0402107	PODNOŽJE DIVANTE CD 140

	D	Š	VM	Vol.
▪ ▪ Divante 140 × 140	1400	1400	620	240 l
▪ ▪ Divante 140 × 140 / O	1400	1400	620	240 l



### Royal 130 × 130 / 120 × 120

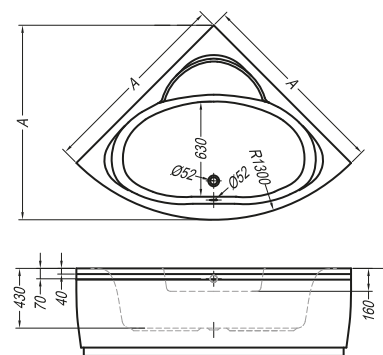

Š.Vokel	Opis
0401292	KADA ROYAL 130x130 BIJELA
0402081	OBLOGA ZA KADU ROYAL 130
0401314	KADA ROYAL 120x120 BIJELA
0402082	OBLOGA ZA KADU ROYAL 120
0402068	PODNOŽJE ZA KADE CK 120-150

	A	B	Vol.
▪ ▪ Royal 130 × 130	1300	640	220 l
▪ ▪ Royal 130 × 130 / O	1300	640	220 l
▪ ▪ Royal 120 × 120	1200	620	180 l
▪ ▪ Royal 120 × 120 / O	1200	620	180 l

Opcije:



Mogućnost ugradnje tuš kabine



Mogućnost ugradnje sistema za masažu



Mogućnost ugradnje pipe s tušem



Mogućnost postavljanja kade samostalno u prostor



		D	Š	VM	Vol.
▪	▪ Chad-L 170 × 120	1700	1200	640	325 l
▪	▪ Chad-L 170 × 120 / O	1700	1200	640	325 l

Š.Vokel	Opis
	KADA CHAD L 170x120 BIJELA
	KADA CHAD L 170x120 S OBLOGOM BIJELA

### Chad-L 170 × 120

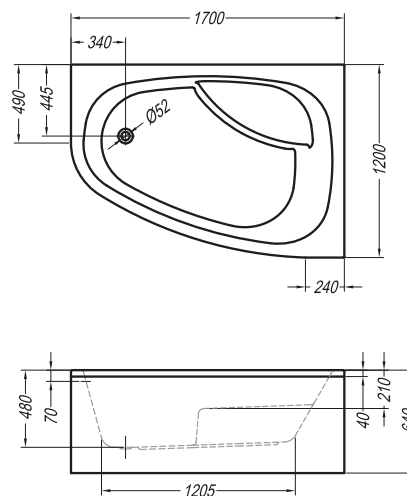

		D	Š	VM	Vol.
▪	▪ Chad-D 170 × 120	1700	1200	640	325 l
▪	▪ Chad-D 170 × 120 / O	1700	1200	640	325 l

Š.Vokel	Opis
	KADA CHAD D 170x120 BIJELA
	KADA CHAD D 170x120 S OBLOGOM BIJELA

### Chad-D 170 × 120

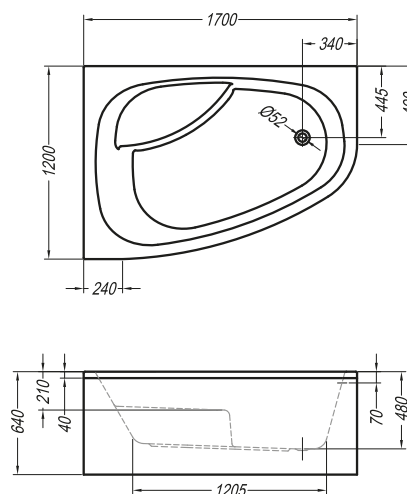

		D	Š	VM	Vol.
▪	▪ Lulu-L 170 × 110	1700	1100	750	350 l
▪	▪ Lulu-L 170 × 110 / O	1700	1100	750	350 l

Š.Vokel	Opis
0401320	KADA LULU L 170x110 BIJELA
0402078	OBLOGA LULU 170 L i D BIJELA
0402069	PODNOŽJE ZA KADU LULU CL 170

### Lulu-L 170 × 110

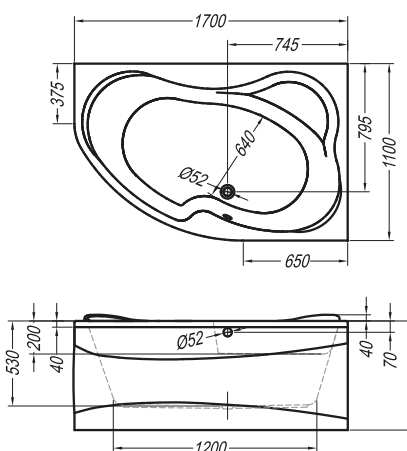





	D	Š	VM	Vol.
▪ ▪ Lulu-D 170 × 110	1700	1100	750	350 l
▪ ▪ ▪ Lulu-D 170 × 110 / O	1700	1100	750	350 l

Š.Vokel	Opis
0401343	KADA LULU D 170x110 BIJELA
0402078	OBLOGA LULU 170 L i D BIJELA
0402069	PODNOŽJE ZA KADU LULU CL 170

### Lulu-D 170 × 110

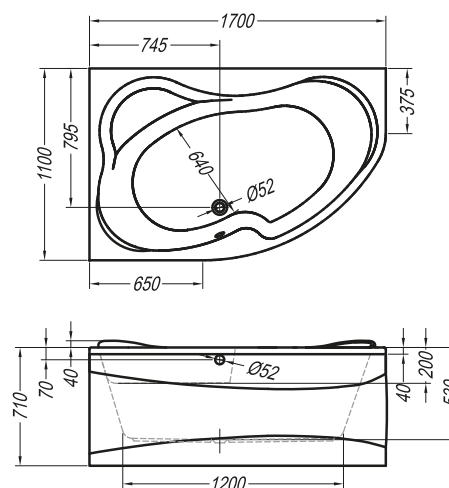

	D	Š	VM	Vol.
▪ ▪ Beatrice-L 170 × 110(70)	1700	1100(700)	610	305 l
▪ ▪ ▪ Beatrice-L 170 × 110(70) / O	1700	1100(700)	610	305 l

Š.Vokel	Opis
	KADA BEATRICE L 170x110 (70) BIJELA
0401371	KADA BEATRICE L 170x110 (70) S OBLOGOM BIJELA

### Beatrice-L 170 × 110(70)

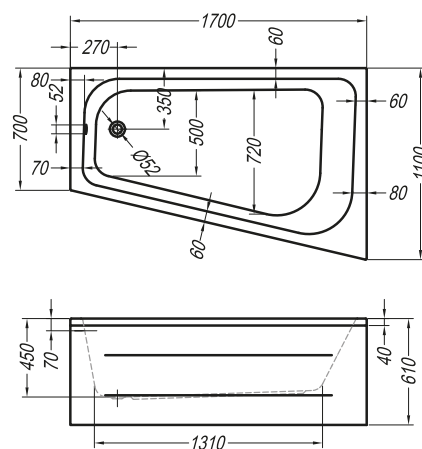

	D	Š	VM	Vol.
▪ ▪ Beatrice-D 170 × 110(70)	1700	1100(700)	610	305 l
▪ ▪ ▪ Beatrice-D 170 × 110(70) / O	1700	1100(700)	610	305 l

Š.Vokel	Opis
	KADA BEATRICE D 170x110 (70) BIJELA
0401365	KADA BEATRICE D 170x110 (70) S OBLOGOM BIJELA

### Beatrice-D 170 × 110(70)

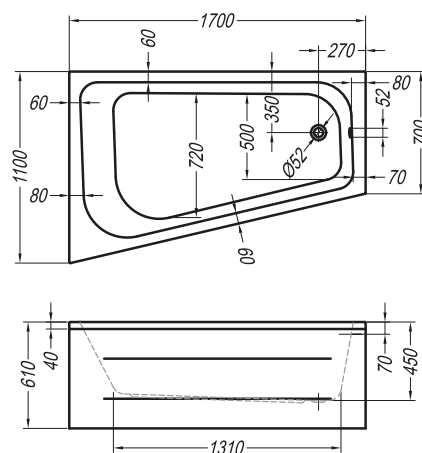

Opcije:



Mogućnost ugradnje tuš kabine



Mogućnost ugradnje sistema za masažu



Mogućnost ugradnje pipe s tušem



Mogućnost postavljanja kade samostalno u prostor



		D	Š	VM	Vol.
<ul style="list-style-type: none"> <li>▪ ▪ ▪ Grazia-L 170 × 80(105)/O</li> </ul>		1700	800(1050)	610	250 l
Š.Vokel	Opis				
0401377	KADA GRAZIA L 170x80(105) S OBLOGOM BIJELA				

### Grazia-L 170 × 80(105)

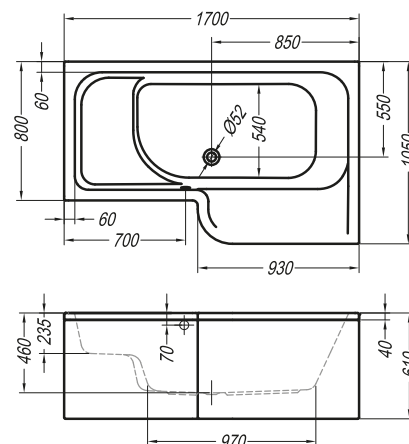

		D	Š	VM	Vol.
<ul style="list-style-type: none"> <li>▪ ▪ ▪ Grazia-D 170 × 80(105)/O</li> </ul>		1700	800(1050)	610	250 l
Š.Vokel	Opis				
0401378	KADA GRAZIA D 170x80(105) S OBLOGOM BIJELA				

### Grazia-D 170 × 80(105)

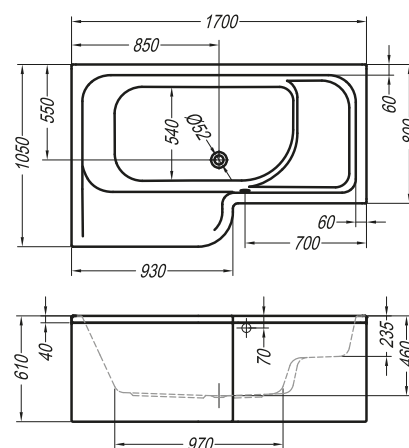

		D	Š	VM	Vol.
<ul style="list-style-type: none"> <li>▪ ▪ Arabela-L 170 × 75(90)</li> </ul>		1700	750(900)	610	245 l
<ul style="list-style-type: none"> <li>▪ ▪ ▪ Arabela-L 170 × 75(90)/O</li> </ul>		1700	750(900)	610	245 l
Š.Vokel	Opis				
	KADA ARABELA L 170x75 (90) BIJELA				
0401235	KADA ARABELA L 170x75 (90) S OBLOGOM BIJELA				

### Arabela-L 170 × 75(90)

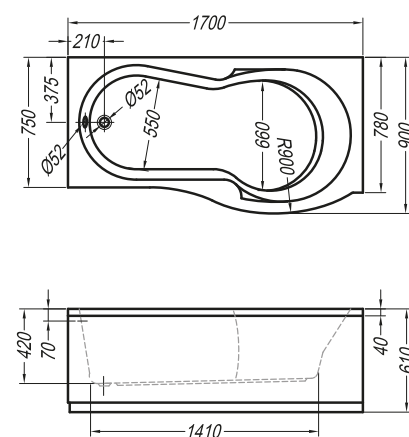



**Arabela-D 170 × 75(90)**

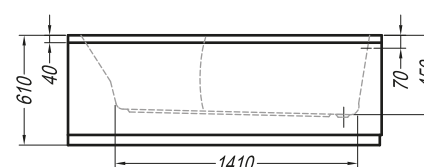
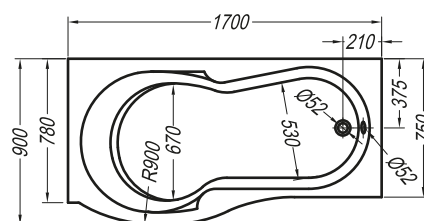

		D	Š	VM	Vol.	
▪	▪	Arabela-D 170 × 75(90)	1700	750(900)	610	245 l
▪	▪	▪ Arabela-D 170 × 75(90)/O	1700	750(900)	610	245 l

Š.Vokel	Opis
66005	KADA ARABELA D 170x75 (90) BIJELA
66139	KADA ARABELA D 170x75 (90) S OBLOGOM BIJELA



**Calando-L 160 × 90**

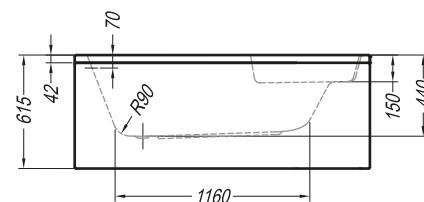
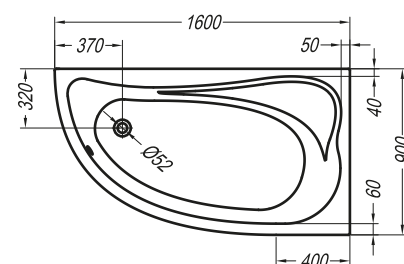

		D	Š	VM	Vol.	
▪	▪	Calando-L 160 × 90	1600	900	615	205 l
▪	▪	▪ Calando-L 160 × 90/O	1600	900	615	205 l

Š.Vokel	Opis
0401381	KADA CALANDO L 160x90 BIJELA
0402126	OBLOGA CALANDO 160 BIJELA
0402060	PODNOŽJE CALANDO 150-180 (ROMEO, VOICE)



**Calando-D 160 × 90**

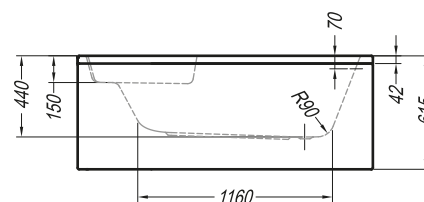
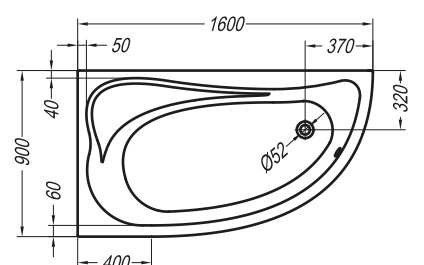

		D	Š	VM	Vol.	
▪	▪	Calando-D 160 × 90	1600	900	615	205 l
▪	▪	▪ Calando-D 160 × 90/O	1600	900	615	205 l

Š.Vokel	Opis
0401382	KADA CALANDO D 160x90 BIJELA
0402126	OBLOGA CALANDO 160 BIJELA
0402060	PODNOŽJE CALANDO 150-180 (ROMEO, VOICE)

Opcije:



Mogućnost ugradnje tuš kabine



Mogućnost ugradnje sistema za masažu



Mogućnost ugradnje pipe s tušem



Mogućnost postavljanja kade samostalno u prostor



**Fidelio-L 160 × 80(45)**

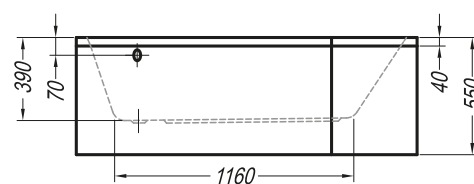
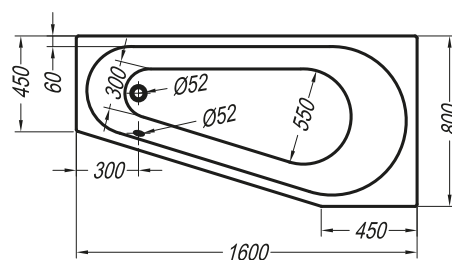

P	D	Š	VM	Vol.
▪ Fidelio-L 160 × 80(45)	1600	800(450)	560	150 l
▪ Fidelio-L 160 × 80(45)/O	1600	800(450)	560	150 l
<b>Š.Vokel</b>	<b>Opis</b>			
<b>06488</b>	KADA FIDELIO L 160x80 (45) BIJELA			
	KADA FIDELIO L 160x80 (45) S OBLOGOM BIJELA			



**Fidelio-D 160 × 80(45)**

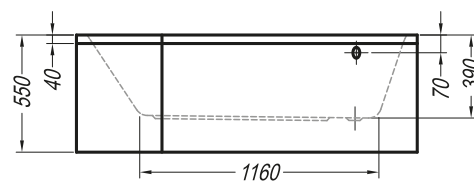
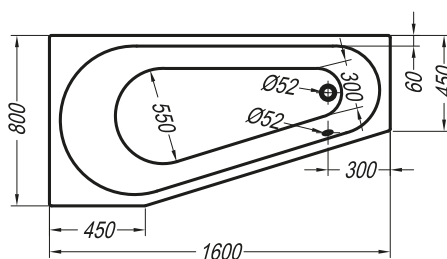

P	D	Š	VM	Vol.
▪ Fidelio-D 160 × 80(45)	1600	800(450)	560	150 l
▪ Fidelio-D 160 × 80(45)/O	1600	800(450)	560	150 l
<b>Š.Vokel</b>	<b>Opis</b>			
<b>06513</b>	KADA FIDELIO D 160x80 (45) BIJELA			
	KADA FIDELIO D 160x80 (45) S OBLOGOM BIJELA			



**Nabucco 190 × 120**

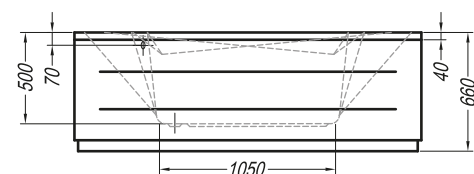
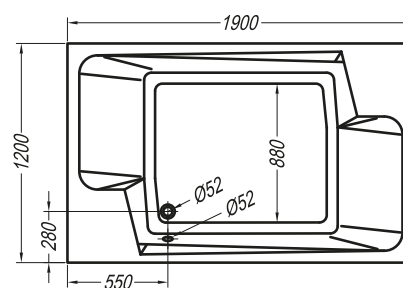

P	D	Š	VM	Vol.
▪ ▪ Nabucco 190 × 120	1900	1200	660	450 l
▪ ▪ Nabucco 190 × 120/O	1900	1200	660	450 l
<b>Š.Vokel</b>	<b>Opis</b>			
<b>06239</b>	KADA NABUCCO 190x120 BIJELA			
<b>0401242</b>	KADA NABUCCO 190x120 S OBLOGOM BIJELA			







**Rapido** 200 × 90 / 190 × 90

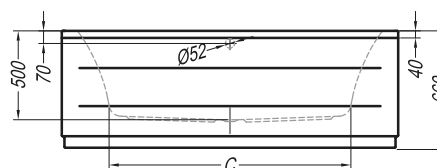
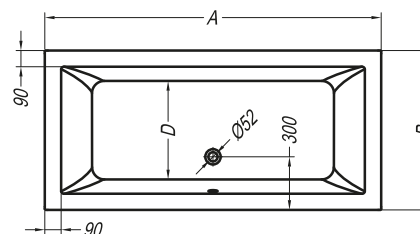

	A	B	C	D	VM	Vol.
▪ ▪ Rapido 200 × 90	2000	900	1470	560	660	360 l
▪ ▪ ▪ Rapido 200 × 90 / O	2000	900	1470	560	660	360 l
▪ ▪ Rapido 190 × 90	1900	900	1370	560	660	345 l
▪ ▪ ▪ Rapido 190 × 90 / O	1900	900	1370	560	660	345 l

Š.Vokel	Opis
0401355	KADA RAPIDO 200x90 BIJELA
0402114	OBLOGA RAPIDO C 200/66 BIJELA
0402115	OBLOGA RAPIDO C 90/66 BIJELA
0402070	PODNOŽJE ZA KADE C 190
0401361	KADA RAPIDO 190x90 BIJELA
0402083	OBLOGA NORMA C 190/66 BIJELA
0402115	OBLOGA RAPIDO C 90/66 BIJELA
0402070	PODNOŽJE ZA KADE C 190



**Norma** 190 × 95

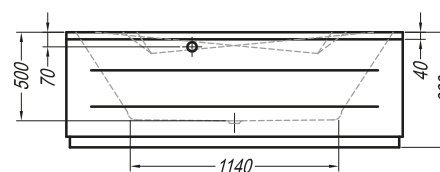
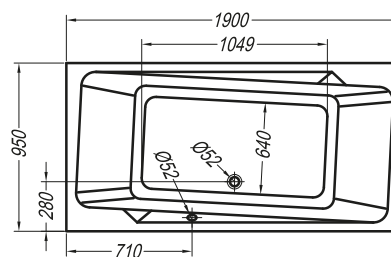

	D	Š	VM	Vol.
▪ ▪ Norma 190 × 95	1900	950	660	360 l
▪ ▪ ▪ Norma 190 × 95 / O	1900	950	660	360 l

Š.Vokel	Opis
0401297	KADA NORMA 190x95 BIJELA
0402083	OBLOGA NORMA C 190/66 BIJELA
0402092	OBLOGA NORMA C 95/66 BIJELA
0402070	PODNOŽJE ZA KADE C 190

Opcije:



Mogućnost ugradnje tuš kabine



Mogućnost ugradnje sistema za masažu



Mogućnost ugradnje pipe s tušem



Mogućnost postavljanja kade samostalno u prostor



### Elektra

190 × 90 / 180 × 80 / 170 × 80 /  
170 × 75 / 170 × 70 / 160 × 75

	A	B	C	D	VM	Vol.
▪ Elektra 190 × 90	1900	900	1345	640	610	360 l
▪ Elektra 190 × 90 / O	1900	900	1345	640	610	360 l
▪ Elektra 180 × 80	1800	800	1200	540	610	265 l
▪ Elektra 180 × 80 / O	1800	800	1200	540	610	265 l
▪ Elektra 170 × 80	1700	800	1145	540	610	245 l
▪ Elektra 170 × 80 / O	1700	800	1145	540	610	245 l
▪ Elektra 170 × 75	1700	750	1080	490	610	205 l
▪ Elektra 170 × 75 / O	1700	750	1080	490	610	205 l
▪ Elektra 170 × 70	1700	700	1145	440	610	200 l
▪ Elektra 170 × 70 / O	1700	700	1145	440	610	200 l
▪ Elektra 160 × 75	1600	750	970	450	610	205 l
▪ Elektra 160 × 75 / O	1600	750	970	450	610	205 l

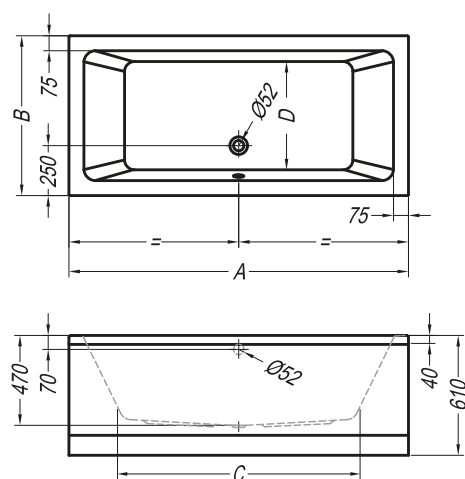

Š.Vokel	Opis
0401299	KADA ELEKTRA 190x90 BIJELA
0402084	OBLOGA ELEKTRA G 190/61 BIJELA
0402094	OBLOGA ELEKTRA G 90/61 BIJELA
0402070	PODNOŽJE ZA KADE C 190
0401300	KADA ELEKTRA 180x80 BIJELA
0402087	OBLOGA ELECTRA, TOSCA G 180/61 BIJELA
0402097	OBLOGA ELECTRA, TOSCA G 80/61 BIJELA
0402066	PODNOŽJE ZA KADE C 160-180
0401301	KADA ELEKTRA 170x80 BIJELA
0402062	OBLOGA DUGA G 170/61 BIJELA
0402097	OBLOGA ELECTRA, TOSCA G 80/61 BIJELA
0402066	PODNOŽJE ZA KADE C 160-180
0401302	KADA ELEKTRA 170x75 BIJELA
0402062	OBLOGA DUGA G 170/61 BIJELA
0402063	OBLOGA KRATKA G 75/61 BIJELA
0402066	PODNOŽJE ZA KADE C 160-180
0401303	KADA ELEKTRA 170x70 BIJELA
0402062	OBLOGA DUGA G 170/61 BIJELA
0402064	OBLOGA KRATKA G 70/61 BIJELA
0402066	PODNOŽJE ZA KADE C 160-180
0401304	KADA ELEKTRA 160x75 BIJELA
0402061	OBLOGA DUGA G 160/61 BIJELA
0402063	OBLOGA KRATKA G 75/61 BIJELA
0402066	PODNOŽJE ZA KADE C 160-180





**Samson 180 × 160**

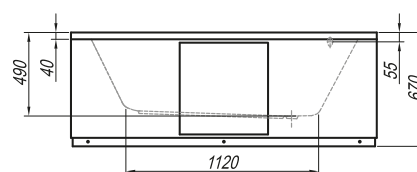
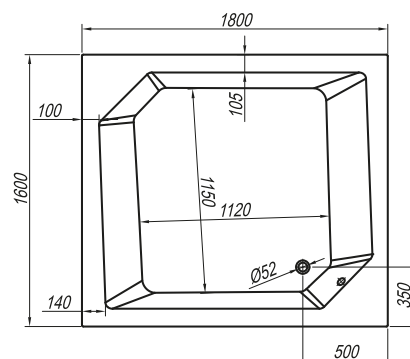

	D	Š	VM	Vol.
▪ ▪ Samson 180 × 160	1800	1600	670	650 l
▪ ▪ ▪ Samson 180 × 160 / 20	1800	1600	670	650 l
▪ ▪ ▪ Samson 180 × 160 / 40	1800	1600	670	650 l

Š.Vokel	Opis
0401276	KADA SAMSON 180x160 BIJELA
0401342	KADA SAMSON 180x160 S 2 OBLOGE BIJELA
0401353	KADA SAMSON 180x160 S 4 OBLOGE BIJELA
0401285	KADA SAMSON 180x160 S 4 OBLOGE + PIPA BIJELO



**Vanessa 180 × 90**

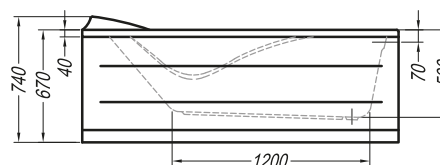
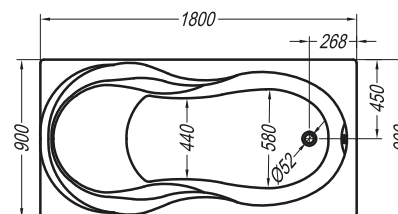

	D	Š	VM	Vol.
▪ ▪ Vanessa 180 × 90	1800	900	660	265 l
▪ ▪ ▪ Vanessa 180 × 90 / O	1800	900	660	265 l

Š.Vokel	Opis
0401308	KADA VANESSA 180x90 BIJELA
0402121	OBLOGA DUGA C 180/66 BIJELA
0402115	OBLOGA RAPIDO C 90/66 BIJELA
0402066	PODNOŽJE ZA KADE C 160-180

Opcije:



Mogućnost ugradnje tuš kabine



Mogućnost ugradnje sistema za masažu



Mogućnost ugradnje pipe s tušem



Mogućnost postavljanja kade samostalno u prostor



**Aida** 180 × 80 / 170 × 75 / 160 × 75

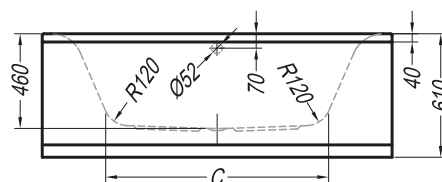
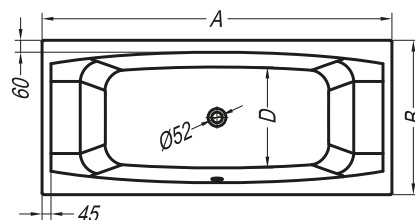

	A	B	C	D	VM	Vol.
Aida 180 × 80	1800	800	1150	525	610	250 l
Aida 180 × 80 / O	1800	800	1150	525	610	250 l
Aida 170 × 75	1700	750	1085	490	610	205 l
Aida 170 × 75 / O	1700	750	1085	490	610	205 l
Aida 160 × 75	1600	750	990	490	610	195 l
Aida 160 × 75 / O	1600	750	990	490	610	195 l

Š.Vokel	Opis
0401370	KADA AIDA 180x80 BIJELA
0402087	OBLOGA ELECTRA, TOSCA G 180/61 BIJELA
0402097	OBLOGA ELECTRA, TOSCA G 80/61 BIJELA
0402066	PODNOŽJE ZA KADE C 160-180
0401374	KADA AIDA 170x75 BIJELA
0402062	OBLOGA DUGA G 170/61 BIJELA
0402063	OBLOGA KRATKA G 75/61 BIJELA
0402066	PODNOŽJE ZA KADE C 160-180
0401376	KADA AIDA 160x75 BIJELA
0402061	OBLOGA DUGA G 160/61 BIJELA
0402063	OBLOGA KRATKA G 75/61 BIJELA
0402066	PODNOŽJE ZA KADE C 160-180



**Armida** 180 × 80

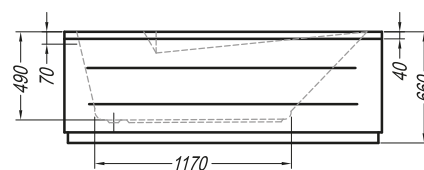
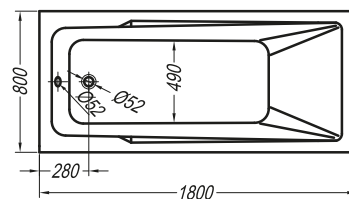

	D	Š	VM	Vol.
Armida 180 × 80	1800	800	660	280 l
Armida 180 × 80 / O	1800	800	660	280 l

Š.Vokel	Opis
0401298	KADA ARMIDA 180x80 BIJELA
0402121	OBLOGA DUGA C 180/66 BIJELA
0402122	OBLOGA KRATKA C 80/66 BIJELA
0402066	PODNOŽJE ZA KADE C 160-180





**Carmen 180 × 80 / 170 × 75**

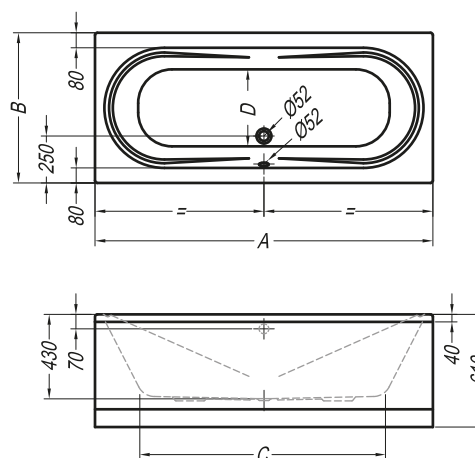

	A	B	C	D	VM	Vol.
▪ ▪ Carmen 180 × 80	1800	800	1240	520	610	255 l
▪ ▪ ▪ Carmen 180 × 80 / O	1800	800	1240	520	610	255 l
▪ ▪ ▪ Carmen 170 × 75	1700	750	1140	430	610	215 l
▪ ▪ ▪ ▪ Carmen 170 × 75 / O	1700	750	1140	430	610	215 l

Š.Vokel	Opis
0401318	KADA CARMEN 180x80 BIJELA
0402087	OBLOGA ELECTRA, TOSCA G 180/61 BIJELA
0402097	OBLOGA ELECTRA, TOSCA G 80/61 BIJELA
0402066	PODNOŽJE ZA KADE C 160-180
0401319	KADA CARMEN 170x75 BIJELA
0402062	OBLOGA DUGA G 170/61 BIJELA
0402063	OBLOGA KRATKA G 75/61 BIJELA
0402066	PODNOŽJE ZA KADE C 160-180



**Valis 170 × 80 / 160 × 70**

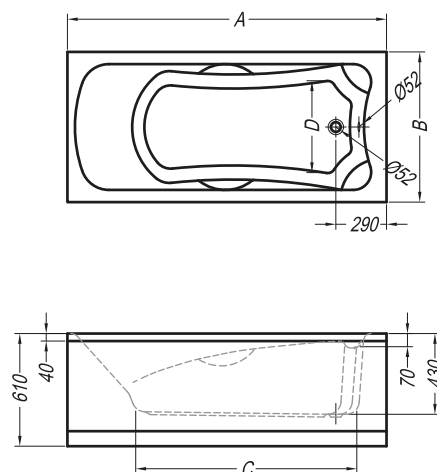

	A	B	C	D	VM	Vol.
▪ ▪ Valis 170 × 80	1700	800	1180	580	610	230 l
▪ ▪ ▪ Valis 170 × 80 / O	1700	800	1180	580	610	230 l
▪ ▪ Valis 160 × 70	1600	700	1000	510	610	210 l
▪ ▪ ▪ Valis 160 × 70 / O	1600	700	1000	510	610	210 l

Š.Vokel	Opis
0401321	KADA VALIS 170x80 BIJELA
0402062	OBLOGA DUGA G 170/61 BIJELA
0402097	OBLOGA ELECTRA, TOSCA G 80/61 BIJELA
0402066	PODNOŽJE ZA KADE C 160-180
0401322	KADA VALIS 160x70 BIJELA
0402061	OBLOGA DUGA G 160/61 BIJELA
0402064	OBLOGA KRATKA G 70/61 BIJELA
0402066	PODNOŽJE ZA KADE C 160-180

Opcije:



Mogućnost ugradnje tuš kabine



Mogućnost ugradnje sistema za masažu



Mogućnost ugradnje pipe s tušem



Mogućnost postavljanja kade samostalno u prostor





### Destiny

180 × 80 / 170 × 75 / 170 × 70 / 160 × 70

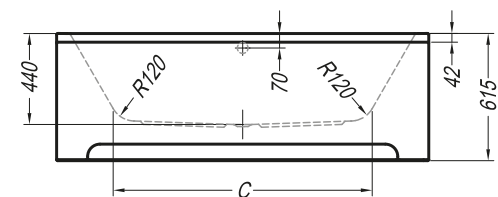
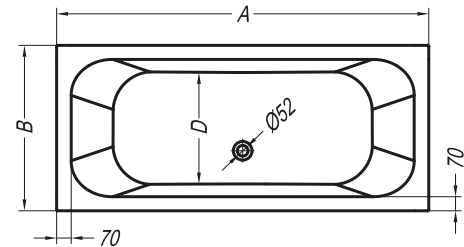

	A	B	C	D	VM	Vol.
▪ ▪ Destiny 180 × 80	1800	800	1250	540	615	250 l
▪ ▪ Destiny 180 × 80 / O	1800	800	1250	540	615	250 l
▪ ▪ Destiny 170 × 75	1700	750	1150	490	615	220 l
▪ ▪ Destiny 170 × 75 / O	1700	750	1150	490	615	220 l
▪ ▪ Destiny 170 × 70	1700	700	1150	440	615	205 l
▪ ▪ Destiny 170 × 70 / O	1700	700	1150	440	615	205 l
▪ ▪ Destiny 160 × 70	1600	700	1050	440	615	190 l
▪ ▪ Destiny 160 × 70 / O	1600	700	1050	440	615	190 l

Š.Vokel	Opis
0401386	KADA DESTINY 180x80 BIJELA
0402130	OBLOGA DESTINY 180x80 BIJELA
0401384	KADA DESTINY 170x75 BIJELA
0402128	OBLOGA DESTINY 170x75 BIJELA
0401385	KADA DESTINY 170x70 BIJELA
0402129	OBLOGA DESTINY 170x70 BIJELA
0401383	KADA DESTINY 160x70 BIJELA
0402127	OBLOGA DESTINY 160x70 BIJELA



### Carol/S 170 × 80

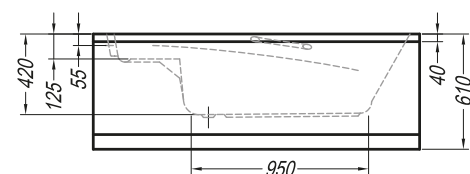
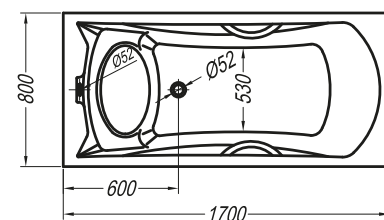

	D	Š	VM	Vol.
▪ Carol 170 × 80/S	1700	800	610	190 l
▪ Carol 170 × 80 / SO	1700	800	610	190 l

Š.Vokel	Opis
0401325	KADA CAROL 170x80 SA SJEDALOM BIJELA
0402062	OBLOGA DUGA G 170/61 BIJELA
0402097	OBLOGA ELECTRA, TOSCA G 80/61 BIJELA
0402072	PODNOŽJE ZA KADE CS 140-170





### Tamia

170 × 75 / 170 × 70 / 160 × 70 / 150 × 70 / 140 × 70

Icon	A	B	C	D	VM	Vol.	
▪	Tamia 170 × 75	1700	750	1290	520	615	230 l
▪	Tamia 170 × 75 / O	1700	750	1290	520	615	230 l
▪	Tamia 170 × 70	1700	700	1260	460	615	215 l
▪	Tamia 170 × 70 / O	1700	700	1260	460	615	215 l
▪	Tamia 160 × 70	1600	700	1195	480	615	180 l
▪	Tamia 160 × 70 / O	1600	700	1195	480	615	180 l
▪	Tamia 150 × 70	1500	700	1100	480	615	170 l
▪	Tamia 150 × 70 / O	1500	700	1100	480	615	170 l
▪	Tamia 140 × 70	1400	700	1000	480	615	155 l
▪	Tamia 140 × 70 / O	1400	700	1000	480	615	155 l

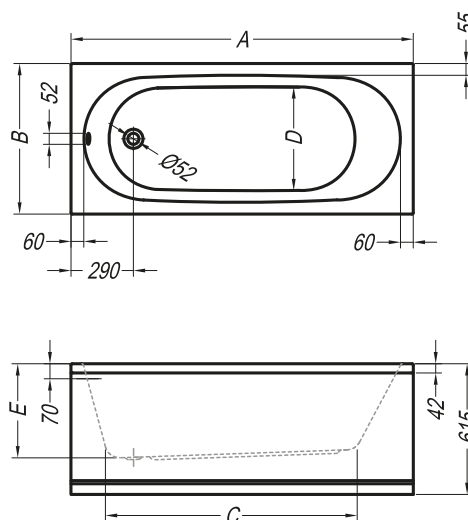

Š.Vokel	Opis
0401347	KADA TAMIA 170x75 BIJELA
0402108	OBLOGA S PODNOŽJEM TAMIA 170x75 BIJELA
0401362	KADA TAMIA 170x70 BIJELA
0402119	OBLOGA S PODNOŽJEM TAMIA 170x70 BIJELA
0401348	KADA TAMIA 160x70 BIJELA
0402109	OBLOGA S PODNOŽJEM TAMIA 160x70 BIJELA
0401349	KADA TAMIA 150x70 BIJELA
0402110	OBLOGA S PODNOŽJEM TAMIA 150x70 BIJELA
0401350	KADA TAMIA 140x70 BIJELA
0402111	OBLOGA S PODNOŽJEM TAMIA 140x70 BIJELA



### Tamia/S 140 × 70

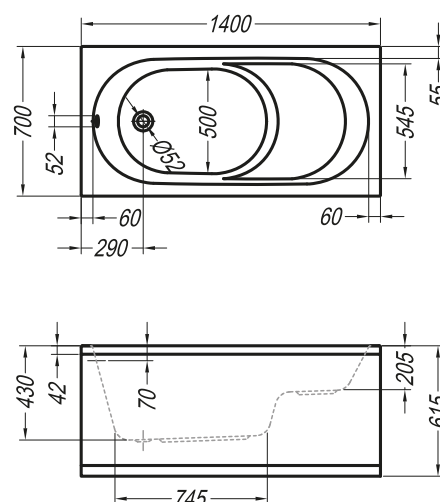

Icon	A	B	C	D	VM	Vol.	
▪	Tamia 140 × 70/S	1400	700	745	500	615	135 l
▪	Tamia 140 × 70 / SO	1400	700	745	500	615	135 l

Š.Vokel	Opis
0401351	KADA TAMIA 140x70 SA SJEDALOM BIJELA
0402111	OBLOGA S PODNOŽJEM TAMIA 140x70 BIJELA

Opcije:



Mogućnost ugradnje tuš kabine



Mogućnost ugradnje sistema za masažu



Mogućnost ugradnje pipe s tušem



Mogućnost postavljanja kade samostalno u prostor



**Figaro** 170 × 75 / 150 × 70

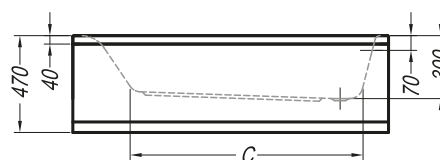
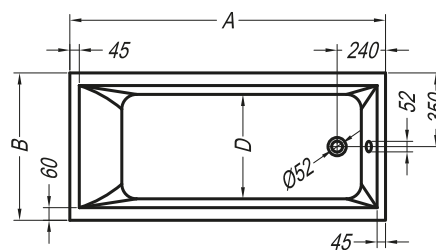

	A	B	C	D	VM	Vol.
▪ ▪ Figaro 170 × 75	1700	750	1320	520	470	145 l
▪ ▪ Figaro 170 × 75 / O	1700	750	1320	520	470	145 l
▪ ▪ Figaro 150 × 70	1500	700	1110	500	470	120 l
▪ ▪ Figaro 150 × 70 / O	1500	700	1110	500	470	120 l

Š.Vokel	Opis
0401332	KADA FIGARO 170x75 BIJELA
0402088	OBLOGA ZA KADU FIGARO G 170/46 BIJELA
0402098	OBLOGA ZA KADU FIGARO G 75/46 BIJELA
0402071	PODNOŽJE ZA KADU CF 170
0401357	KADA FIGARO 150x70 BIJELA
0402116	OBLOGA ZA KADU FIGARO G 150/46 BIJELA
0402117	OBLOGA ZA KADU FIGARO G 70/46 BIJELA
0402071	PODNOŽJE ZA KADU CF 170



**Adela** 160 × 70 / 150 × 70

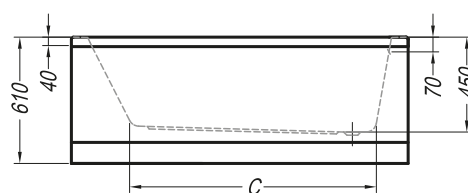
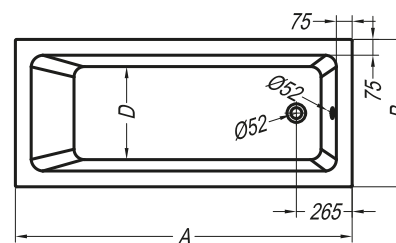

	A	B	C	D	VM	Vol.
▪ ▪ Adela 160 × 70	1600	700	1170	440	610	220 l
▪ ▪ Adela 160 × 70 / O	1600	700	1170	440	610	220 l
▪ ▪ Adela 150 × 70	1500	700	1070	440	610	200 l
▪ ▪ Adela 150 × 70 / O	1500	700	1070	440	610	200 l

Š.Vokel	Opis
0401305	KADA ADELA 160x70 BIJELA
0402061	OBLOGA DUGA G 160/61 BIJELA
0402064	OBLOGA KRATKA G 70/61 BIJELA
0402066	PODNOŽJE ZA KADE C 160-180
0401306	KADA ADELA 150x70 BIJELA
0402089	OBLOGA DUGA G 150/61 BIJELA
0402064	OBLOGA KRATKA G 70/61 BIJELA
0402073	PODNOŽJE ZA KADE C 130-150





### Accordo 140 × 70

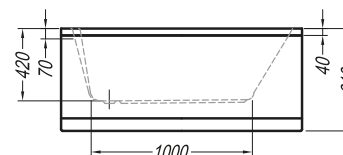
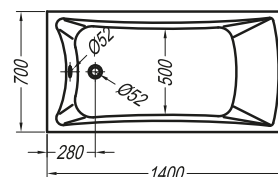

Š.Vokel	Opis
0401330	KADA ACCORDO 140x70 BIJELA
0402090	OBLOGA ACCORDO G 140-61 BIJELA
0402064	OBLOGA KRATKA G 70/61 BIJELA
0402073	PODNOŽJE ZA KADE C 130-150

■ ■	D	Š	VM	Vol.	
■ ■	Accordo 140 × 70	1400	700	610	180 l
■ ■	Accordo 140 × 70 / O	1400	700	610	180 l



### Accordo/S 140 × 70

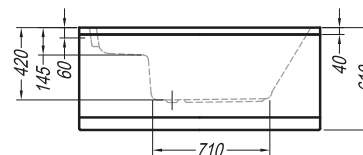
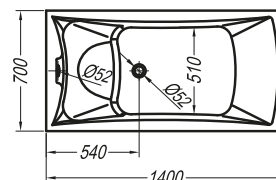

Š.Vokel	Opis
0401329	KADA ACCORDO 140x70 SA SJEDALOM BIJELA
0402090	OBLOGA ACCORDO G 140-61 BIJELA
0402064	OBLOGA KRATKA G 70/61 BIJELA
0402072	PODNOŽJE ZA KADE CS 140-170

■ ■	D	Š	VM	Vol.	
■ ■	Accordo 140 × 70/S	1400	700	610	130 l
■ ■	Accordo 140 × 70 / S O	1400	700	610	130 l



### Ester 130 × 70

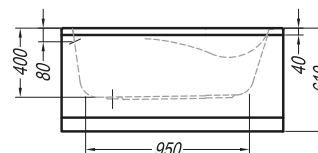
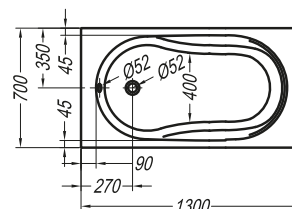

Š.Vokel	Opis
0401328	KADA ESTER 130x70 BIJELA
0402091	OBLOGA DUGA G 130/61 BIJELA
0402064	OBLOGA KRATKA G 70/61 BIJELA
0402073	PODNOŽJE ZA KADE C 130-150

■ ■	D	Š	VM	Vol.	
■ ■	Ester 130 × 70	1300	700	610	130 l
■ ■	Ester 130 × 70 / O	1300	700	610	130 l

Opcije:



Mogućnost ugradnje tuš kabine



Mogućnost ugradnje sistema za masažu



Mogućnost ugradnje pipe s tušem



Mogućnost postavljanja kade samostalno u prostor



**Cavatina/S 120 x 70**

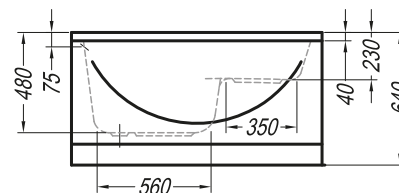
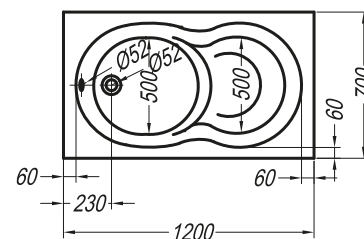

	D	Š	VM	Vol.
▪ Cavatina 120 x 70/S	1200	700	640	115 l
▪ Cavatina 120 x 70 / SO	1200	700	640	115 l

Š.Vokel	Opis
0401331	KADA CAVATINA 120x70 SA SJEDALOM BIJELA
0402065	OBLOGA S PODNOŽJEM CAVATINA 120x70



**Boogie 120 x 75**

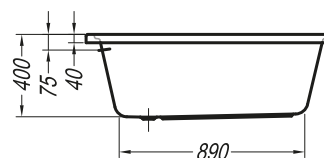
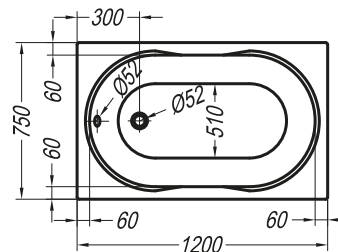

	D	Š	VM	Vol.
▪ ▪ Boogie 120 x 75	1200	750	570	120 l

Š.Vokel	Opis
06401	KADA BOOGIE 120x75 BIJELA



**Mini 100 x 70**

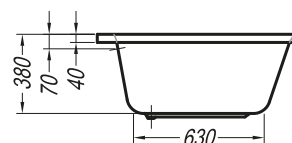
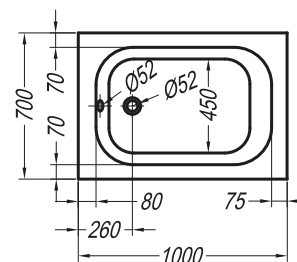

	D	Š	VM	Vol.
▪ ▪ Mini 100 x 70	1000	700	550	110 l

Š.Vokel	Opis
06201	KADA MINI 100x70 BIJELA





## Kupaonska sjedala



109 bijela	9017 stardust
1087 dolomite grain	9070 graphite
5194 rhyolite	

**SL-K sjedalo za tuš kabinu od Kerrocka - preklopno** (nosivost do 110 kg)



Š. Vokel 0402055



**STK sjedalo za tuš kabinu - preklopno** (nosivost do 110 kg)



**KS-PU kupaonska stolica, h=42 cm, prijenosna**



**STK-PU sjedalo za tuš kabinu - preklopno** (nosivost do 110 kg)



Š. Vokel 0402100

**KS kupaonska stolica, h=40 cm, prijenosna**

## Kupaonska sjedala



Š. Vokel 0402054

**SKK sjedalo za kupaonsku kadu** (nosivost do 130 kg)



Š. Vokel 0402056

**SKN sjedalo za kupaonsku kadu, sa naslonom**  
(nosivost do 130 kg)

## Naslone za glavu



Š. Vokel 0402031

**DROP - naslon za glavu**  
Za sve modele kupaonskih kada



Š. Vokel 0402030

**VANILLA - naslon za glavu**  
Za sve modele kupaonskih kada



Š. Vokel 0402057

**SAM - naslon za glavu**  
Samson, Norma, Nabucco,  
Armida, Elektra, Adela,  
Grazia, Destiny



**VIAR - naslon za glavu**  
Vivo, Swan, Arabela

## Dodaci kupaonskim kadama

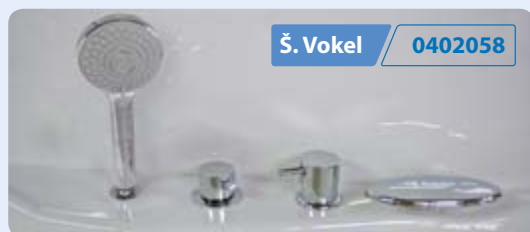

Š. Vokel 0402058

Baterija sa tuš ručicom za kade sa oblogom

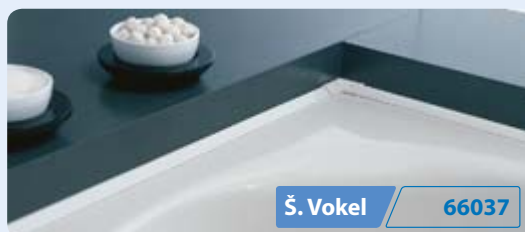

Š. Vokel 66037



Završna lajsna za kade i tuš kade

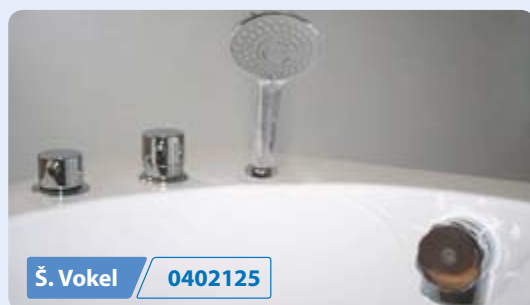

Š. Vokel 0402125

Jednoručna armatura s tuš ručicom i priljev / odljev prelivnom garniturom za punjenje kada

## Dodaci kupaonskim kadama i tuš kadama



Preljevna garnitura



Š. Vokel 0404273

Sifon Ø 90 za tuš kade

Bono, Vip, Canary, Macarena, Flamenco, Salsa, Rumba, Haka, Whip, Boston, Malur, Eisa, Pony



Servisno ventilacijski pokrov s rešetkom

## Podnožja kada za kupanje

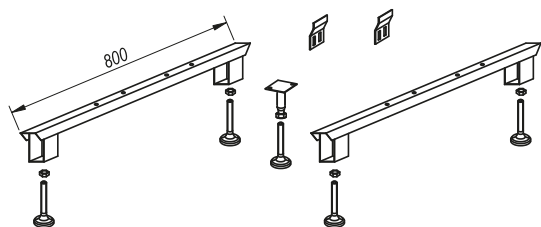

### 800 PKK

Nabucco, Norma, Gloriana, Libero, Elektra 190, Rapido 200, 190, Vivo.

Š. Vokel 66100

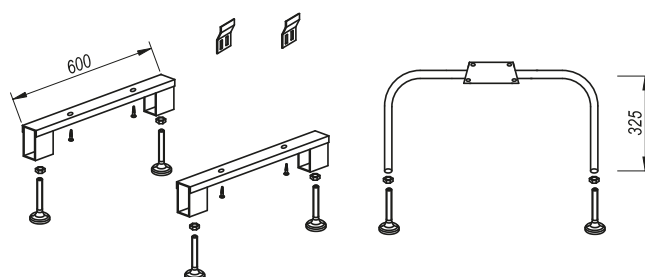

### 1001 B

Piano, Alba, Loco, Swan, Allegro.

Š. Vokel 05437

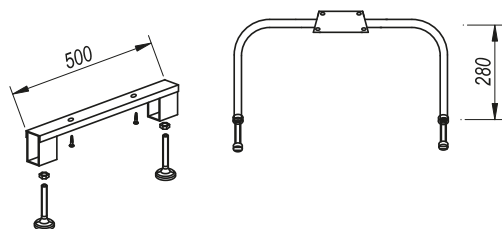

### 1300 PKO

Cavatina

Š. Vokel 05591

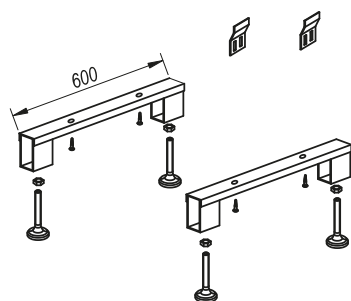

### 1001 L

Largo, Lulu, Royal, Beatrice Divante, Volante

Š. Vokel 66099

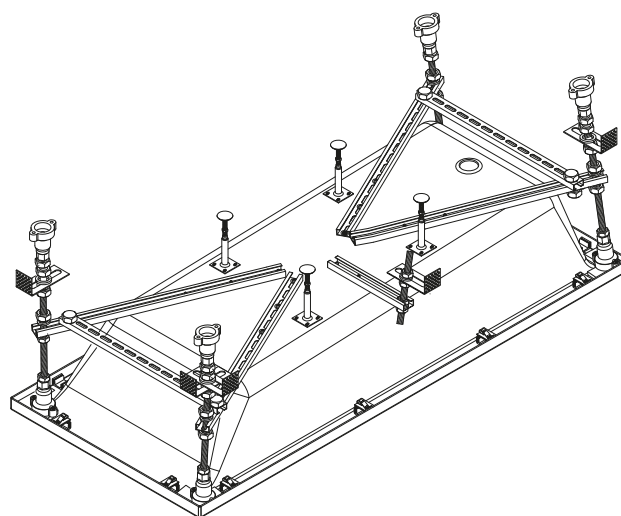

### C KIT

Podnožje za obloge

Š. Vokel

## Sredstva za čiščenje, dezinfekcijska sredstva, premazi



### KOLPA SAN, SPECIJALNO SREDSTVO ZA ČIŠČENJE

Specijalno sredstvo Kolpa san učinkovito uklanja vodeni kamenec na kupaonskim i tuš kadama i sa stakla tuš kabina.

Š. Vokel 06535



### ECO SAN, SPECIJALNO SREDSTVO ZA ČIŠČENJE

Specijalno sredstvo za čiščenje neškodljivo za okoliš Eco san vrlo učinkovito uklanja vodeni kamenec na kupaonskim i tuš kadama i sa stakla tuš kabina.



### SREDSTVO ZA ČIŠČENJE ZA SAVRŠENU HIGIJENU MASAŽNIH KADA

Š. Vokel 06534



### KOLPA SAN, ZAŠTITNI PREMAZ

Kolpa san zaštitni premaz za staklo i keramiku.



### KERIL, SPECIJALNO KREMASTO ABRAZIVNO SREDSTVO ZA ČIŠČENJE

Specijalno sredstvo za čiščenje Kerrock ploča, Kerrock površina i nehrđajućeg čelika.

### KOLPA SAN, MAST ZA LEŽAJEVE TUŠ KABINA



Bolje za okoliš...



- smanjen utjecaj na vodene organizme
- smanjena količina opasnih tvari
- smanjena količina otpadne ambalaža

...bolje za vas.

EU Ecolabel: SI / 020 / 01





**LIJEVANI MRAMOR - SANITARNI AKRIL - ROCK LINE**



[www.kolpa.si](http://www.kolpa.si)



**kolpa-san**<sup>®</sup>  
by kolpa

## Tuš kade



**kolpa-san**<sup>®</sup>  
by kolpa

**Lerock ZERO** 120 × 90 / 100 × 100



**Lerock ZERO** 120 × 90 / 100 × 100 **CREPE**



**Sistem ugradnje za Lerock ZERO, CREPE**



- |                       |                    |
|-----------------------|--------------------|
| 1 - tuš kada          | 6 - stiropor 40 mm |
| 2 - sanitarni silikon | 7 - stiropor 30 mm |
| 3 - keramika          | 8 - stiropor 20 mm |
| 4 - water stop folija | 9 - mapelastic     |
| 5 - stiropor 60 mm    |                    |

**Lerock ZERO CREPE**



**109 white**

**514 sandstone**

Ugradnja u razini poda s mogućnošću kompenzacije visine do maks. 15 cm.

**Re-walk** 180 × 80 / 140 × 80



**Re-walk** 180 × 80

- tuš kada od lijevanog mramora s plitkim dnom, mogućnost rezanja lijevo, desno i straga do dimenzije 140x70 cm

**Re-walk** 140 × 80

- tuš kada od lijevanog mramora s plitkim dnom, mogućnost rezanja lijevo, desno i straga do dimenzije 110x70 cm

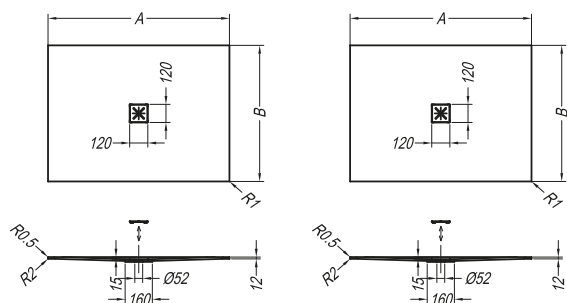

Lerock Zero

Lerock Zero Crepe

### Lerock Zero

Š. Vokel	A	B	VM
Lerock Zero 120 × 90	1200	900	162
Lerock Zero 100 × 100	1000	1000	162

### Lerock Zero Crepe

Š. Vokel	A	B	VM
Lerock Zero Crepe 120 × 90	1200	900	162
Lerock Zero Crepe 100 × 100	1000	1000	162

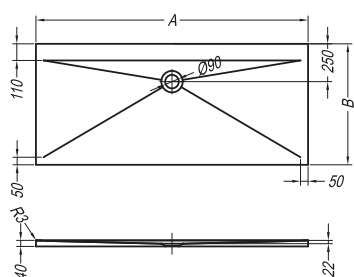

Re-walk

### Re-walk

Š. Vokel	A	B	VM
Re-walk 180 × 80	1800	800	120
<b>0404383</b> Re-walk 140 × 80	1400	800	120



Želite li usavršiti proizvod?

Dodaci za tuš kade



Povećajte udobnost svoje tuš kabine!

Kupaonska sjedala



Pobrinite se za zaštitu svoje kupaonice!

Zaštitni premaz



**Bono** 140 × 90



**Vip** 120 × 90



**Vals** 120 × 90 / 120 × 80 / 90 × 90



**Canary** 140×90/120×90/120×80/100×100/100×80/90×90/90×75

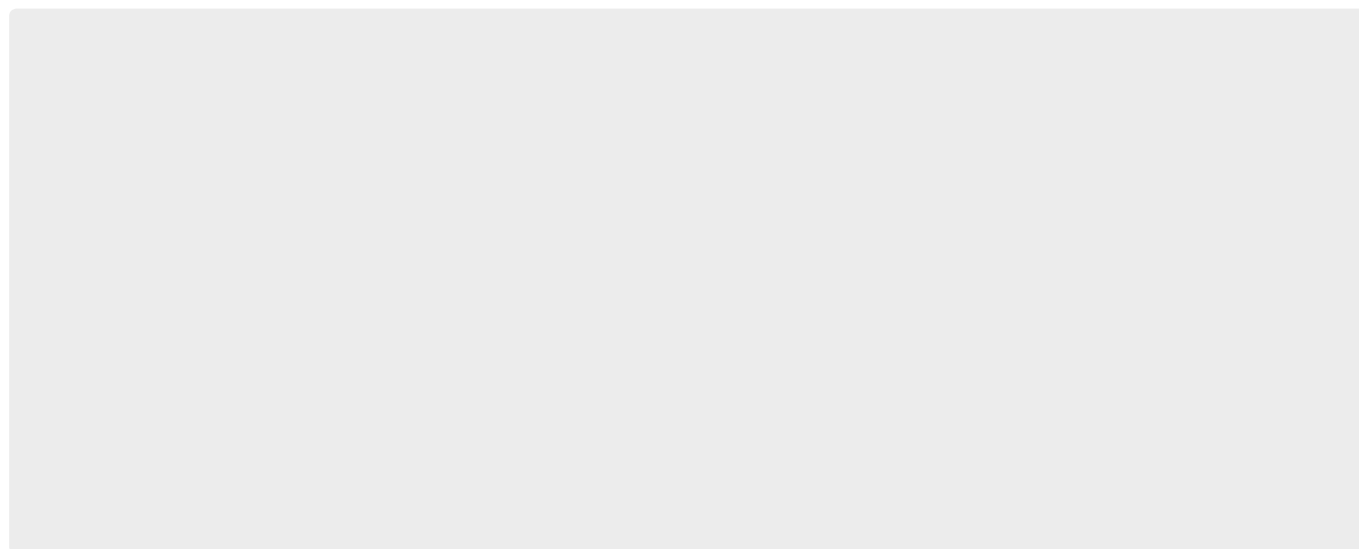



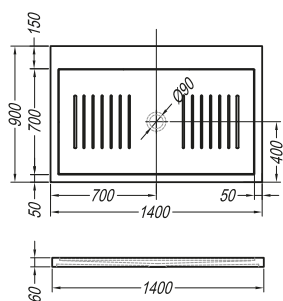

Bono 140 × 90

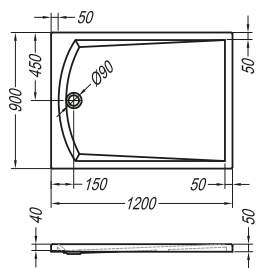

Vip 120 × 90

### Bono

P	Š. Vokel	D	Š	VM	
▪	0404279	Bono 140 × 90	1400	900	160

### Vip

P	Š. Vokel	D	Š	VM	
▪	0404280	Vip 120 × 90	1200	900	165

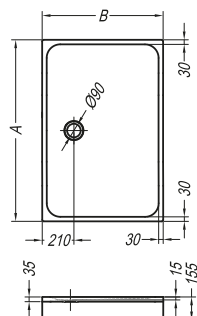

Vals

### Vals

P	Š. Vokel	A	B	VM	
▪		Vals 120 × 90	1200	900	155
▪	0404370	Vals 120 × 90/O	1200	900	155
▪		Vals 120 × 80	1200	800	155
▪		Vals 120 × 80/O	1200	800	155
▪	0404386	Vals 90 × 90	900	900	155
▪		Vals 90 × 90/O	900	900	155

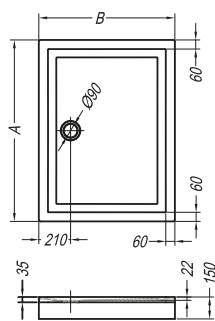

Canary

### Canary

P	Š. Vokel	A	B	VM	
▪	0404282	Canary 140 × 90	1400	900	150
▪	0404283	Canary 140 × 90 / O	1400	900	150
▪	0404284	Canary 120 × 90	1200	900	150
▪	0404285	Canary 120 × 90 / O	1200	900	150
▪	0404281	Canary 120 × 80	1200	800	150
▪	0404286	Canary 120 × 80 / O	1200	800	150
▪	0404287	Canary 100 × 100	1000	1000	150
▪	0404288	Canary 100 × 100 / O	1000	1000	150
▪	0404289	Canary 100 × 80	1000	800	150
▪	0404290	Canary 100 × 80 / O	1000	800	150
▪	0404291	Canary 90 × 90	900	900	150
▪	0404292	Canary 90 × 90 / O	900	900	150
▪	0404366	Canary 90 × 75	900	750	150
▪		Canary 90 × 75 / O	900	750	150

**Macarena** 100×100/90×90



**Flamenco** 180×80/170×80/170×75/160×70/140×90/140×80



**Flamenco** 130×90/120×90/120×80/120×70/110×90/110×80



**Flamenco** 100×90/100×80/90×90/90×70/70×70

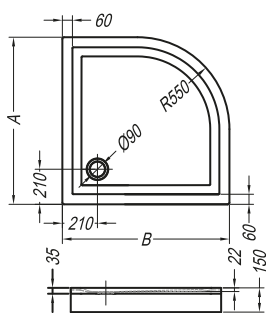

Macarena

**Macarena**

P	Š. Vokel	A	B	VM
▪	0404293 Macarena 100 × 100	1000	1000	150
▪	0404294 Macarena 100 × 100 / O	1000	1000	150
▪	0404274 Macarena 90 × 90	900	900	150
▪	0404295 Macarena 90 × 90 / O	900	900	150

## Flamenco

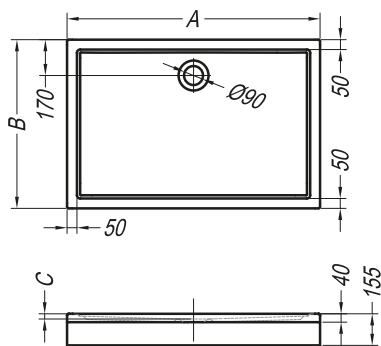

Flamenco

Š. Vokel	A	B	C	VM
0404373 Flamenco 100 × 80	1000	800	25	155
0404374 Flamenco 100 × 80 / O	1000	800	25	155
0404321 Flamenco 90 × 90	900	900	25	155
0404322 Flamenco 90 × 90 / O	900	900	25	155
0404377 Flamenco 90 × 70	900	700	25	155
0404378 Flamenco 90 × 70 / O	900	700	25	155
0404368 Flamenco 70 × 70	700	700	25	155
0404369 Flamenco 70 × 70 / O	700	700	25	155
0404310 Flamenco 180 × 80	1800	800	35	155
0404311 Flamenco 180 × 80 / O	1800	800	35	155
0404355 Flamenco 170 × 80	1700	800	35	155
0404357 Flamenco 170 × 80 / O	1700	800	35	155
0404345 Flamenco 170 × 75	1700	750	30	155
0404346 Flamenco 170 × 75 / O	1700	750	30	155
0404312 Flamenco 160 × 90	1600	900	35	155
0404313 Flamenco 160 × 90 / O	1600	900	35	155
0404384 Flamenco 160 × 80	1600	800	35	155
0404385 Flamenco 160 × 80 / O	1600	800	35	155
0404314 Flamenco 160 × 70	1600	700	30	155
0404315 Flamenco 160 × 70 / O	1600	700	30	155
0404270 Flamenco 140 × 90	1400	900	25	155
0404271 Flamenco 140 × 90 / O	1400	900	25	155
0404365 Flamenco 140 × 80	1400	800	25	155
0404379 Flamenco 140 × 80 / O	1400	800	25	155
0404387 Flamenco 140 × 70 / O	1400	700	30	155
0404371 Flamenco 130 × 90	1300	900	25	155
0404372 Flamenco 130 × 90 / O	1300	900	25	155
0404316 Flamenco 120 × 90	1200	900	25	155
0404317 Flamenco 120 × 90 / O	1200	900	25	155
0404272 Flamenco 120 × 80	1200	800	25	155
0404318 Flamenco 120 × 80 / O	1200	800	25	155
0404375 Flamenco 120 × 70	1200	700	25	155
0404376 Flamenco 120 × 70 / O	1200	700	25	155
0404276 Flamenco 110 × 90	1100	900	25	155
0404278 Flamenco 110 × 90 / O	1100	900	25	155
0404275 Flamenco 110 × 80	1100	800	25	155
0404277 Flamenco 110 × 80 / O	1100	800	25	155
0404319 Flamenco 100 × 90	1000	900	25	155
0404320 Flamenco 100 × 90 / O	1000	900	25	155

Opcije:



Mogućnost ugradnje tuš kabine

**Salsa** 160×90/140×90/120×90/120×80/100×100/90×90



**Haka** 120×90 / 120×80 / 90×90



**Rock** 100×100 / 90×90 / 80×80



**Step zero** 120×90 / 100×100



### Sistem ugradnje za Step zero

Ugradnja u razini poda s mogućnošću kompenzacije visine do maks. 15 cm.

- |                       |                    |
|-----------------------|--------------------|
| 1 - tuš kada          | 6 - stiropor 40 mm |
| 2 - sanitarni silikon | 7 - stiropor 30 mm |
| 3 - keramika          | 8 - stiropor 20 mm |
| 4 - water stop folija | 9 - mapelastik     |
| 5 - stiropor 60 mm    |                    |



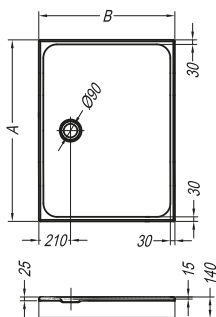

Salsa

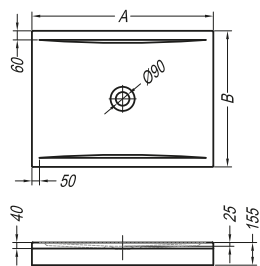

Haka

### Salsa

Š. Vokel	A	B	VM
Salsa 160 × 90	1600	900	140
0404358 Salsa 160 × 90 / O	1600	900	140
0404364 Salsa 140 × 90	1400	900	140
0404359 Salsa 140 × 90 / O	1400	900	140
0404356 Salsa 120 × 90	1200	900	140
0404347 Salsa 120 × 90 / O	1200	900	140
0404361 Salsa 120 × 80	1200	800	140
0404354 Salsa 120 × 80 / O	1200	800	140
0404350 Salsa 100 × 100	1000	1000	140
0404349 Salsa 100 × 100 / O	1000	1000	140
0404367 Salsa 90 × 90	900	900	140
0404348 Salsa 90 × 90 / O	900	900	140

### Haka

Š. Vokel	A	B	VM
Haka 120 × 90	1200	900	155
0404338 Haka 120 × 90 / O	1200	900	155
Haka 120 × 80	1200	800	155
0404353 Haka 120 × 80 / O	1200	800	155
0404388 Haka 90 × 90	900	900	155
0404337 Haka 90 × 90 / O	900	900	155

### Rock

Š. Vokel	A	B	VM
66123 Rock 100 × 100	1000	1000	210
66058 Rock 100 × 100 / O	1000	1000	210
0404268 Rock 90 × 90	900	900	210
66082 Rock 90 × 90 / O	900	900	210
0404171 Rock 90 × 90 / 30	900	900	210
0404166 Rock 80 × 80	800	800	210
66081 Rock 80 × 80 / O	800	800	210
0404170 Rock 80 × 80 / 30	800	800	210

### Step zero

Š. Vokel	A	B	VM
Step zero 120 × 90	1200	900	160
Step zero 100 × 100	1000	1000	160

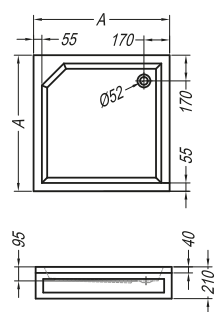

Rock

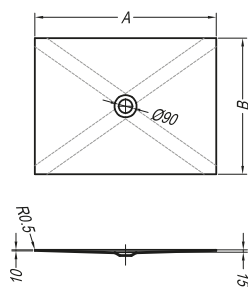

Step zero



**Boston** 100 × 100 / 90 × 90 / 80 × 80



**Beat-in** 90 × 90



**Ska** 90 × 80 -L



**Ska** 90 × 80 -D



**Horon** 90 × 90



**Trin** 90 × 90 / 80 × 80



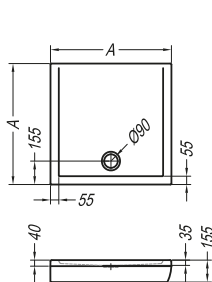

Boston

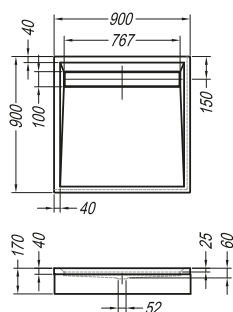

Beat-IN 90 x 90

### Boston

P	Š. Vokel	A	VM
▪	0404296 Boston 100 x 100	1000	155
▪	0404297 Boston 100 x 100 / O	1000	155
▪	0404298 Boston 90 x 90	900	155
▪	0404299 Boston 90 x 90 / O	900	155
▪	0404300 Boston 80 x 80	800	155
▪	0404301 Boston 80 x 80 / O	800	155

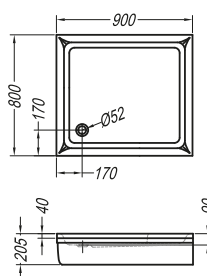

Ska-L 90 x 80

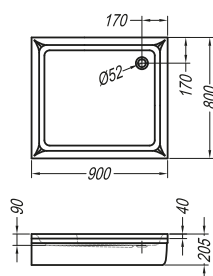

Ska-D 90 x 80

### Beat-In

P	Š. Vokel	D	Š	VM
▪	0404253 Beat-IN 90 x 90	900	900	170
▪	0404207 Beat-IN 90 x 90 / O	900	900	170

### Ska

P	Š. Vokel	A	B	VM
▪	06852 Ska 90 x 80	900	800	205
▪	06739 Ska-L 90 x 80/O	900	800	205
▪	06850 Ska-D 90 x 80/O	900	800	205

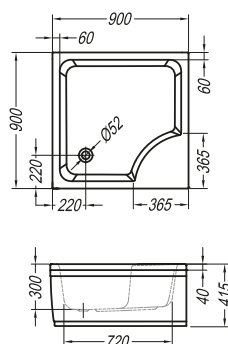

Horon 90 x 90

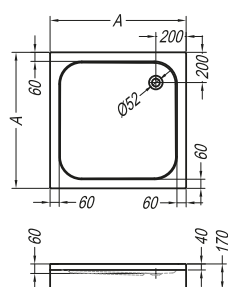

Trin

### Horon

P	Š. Vokel	D	Š	VM
▪	0404242 Horon 90 x 90	900	900	415
▪	0404226 Horon 90 x 90/O	900	900	415

### Trin

P	Š. Vokel	A	VM
▪	0404212 Trin 90 x 90	900	170
▪	0404213 Trin 90 x 90 / O	900	170
▪	0404214 Trin 80 x 80	800	170
▪	0404215 Trin 80 x 80 / O	800	170

**Malur** 120 × 90 / 100 × 80 -L



**Malur** 120 × 90 / 100 × 80 -D



**Eisa** 100 × 100 / 90 × 90



**Blues** 100 × 100 / 90 × 90



**Pony** 90 × 90



**Bossanova** 90 × 90



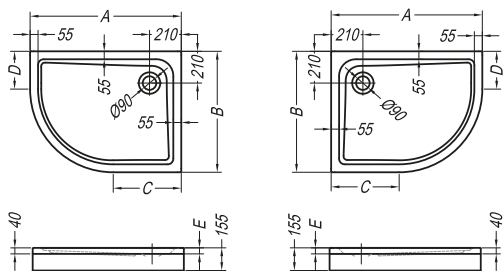

Malur -L

Malur -D

### Malur

Š. Vokel	A	B	C	D	VM
0404303 Malur-L 120 × 90	1200	900	650	350	155
0404304 Malur-L 120 × 90/O	1200	900	650	350	155
0404306 Malur-L 100 × 80	1000	800	450	250	155
0404309 Malur-L 100 × 80/O	1000	800	450	250	155
0404302 Malur-D 120 × 90	1200	900	650	350	155
0404305 Malur-D 120 × 90/O	1200	900	650	350	155
0404307 Malur-D 100 × 80	1000	800	450	250	155
0404308 Malur-D 100 × 80/O	1000	800	450	250	155

### Eisa

Š. Vokel	A	VM
0404352 Eisa 100 × 100	1000	155
0404339 Eisa 100 × 100 / O	1000	155
0404360 Eisa 90 × 90	900	155
0404340 Eisa 90 × 90 / O	900	155

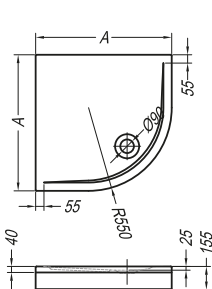

Eisa

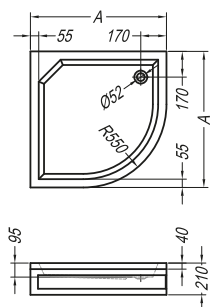

Blues

### Blues

Š. Vokel	A	VM
66093 Blues 100 × 100	1000	210
66076 Blues 100 × 100 / O	1000	210
0404249 Blues 90 × 90	900	210
66064 Blues 90 × 90 / O	900	210
0404169 Blues 90 × 90 / 30	900	210

### Pony

Š. Vokel	A	VM
0404341 Pony 90 × 90	900	155
0404342 Pony 90 × 90 / O	900	155
0404343 Pony 80 × 80	800	155
0404344 Pony 80 × 80 / O	800	155

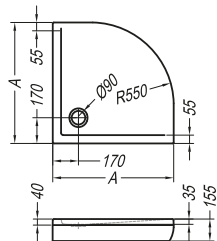

Pony

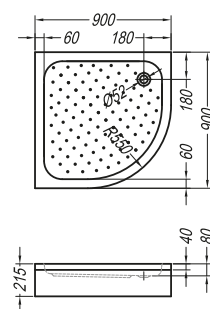

Bossanova 90 × 90

### Bossanova

Š. Vokel	D	Š	VM
66039 Bossanova 90 × 90	900	900	215
66036 Bossanova 90 × 90 / O	900	900	215

Opcije:



Mogućnost ugradnje tuš kabine

**Dixie 90 × 90**



**Bebop 90 × 90**



**Ontex 90 × 90 / 80 × 80**

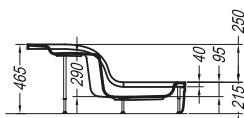
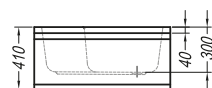
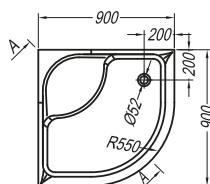
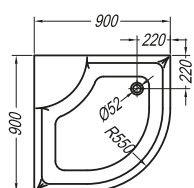

Dixie 90 × 90

Bebop 90 × 90

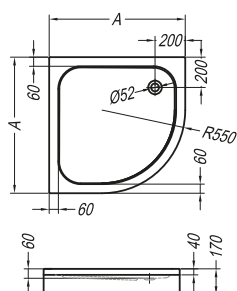

Ontex

**Dixie**

P	Š. Vokel	D	Š	VM
▪	06992 Dixie 90 × 90	900	900	410
▪	06197 Dixie 90 × 90 / O	900	900	410

**Bebop**

P	Š. Vokel	D	Š	VM
▪	06206 Bebop 90 × 90	900	900	215
▪	06989 Bebop 90 × 90 / O	900	900	215

**Ontex**

P	Š. Vokel	A	VM
▪	0404216 Ontex 90 × 90	900	170
▪	0404217 Ontex 90 × 90 / O	900	170
▪	0404218 Ontex 80 × 80	800	170
▪	0404219 Ontex 80 × 80 / O	800	170



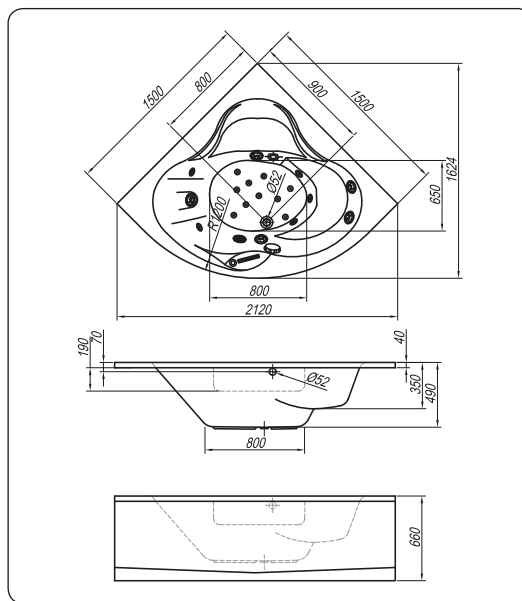

**Lily 150 (Lily 150/O)**

	D	Š	VM	Vol.
Lily 150 x 150	1500	1500	490	270 l

**Masažni sistem VITAL:**

- zračna crpka
  - vodena crpka
  - 5 vodenih mlaznica
  - 5 super vodenih mlaznica
  - 10 zračnih mlaznica
  - regulator protoka zraka min-max
  - elektronički prekidač za vodu i zračnu crpku
  - senzor za razinu vode
  - svjetlo s chromoterapijom
  - ozon
  - intervalna regulacija za vodu
  - oscilirajuća regulacija za zrak
  - grijač za održavanje nastavljene temperature vode
  - programiranje željene temperature vode
  - odjevno-preljevna garnitura
  - podnožje kade za kupanje
- ugradnja armature s tuš ručkom
  - obloga masažne kade

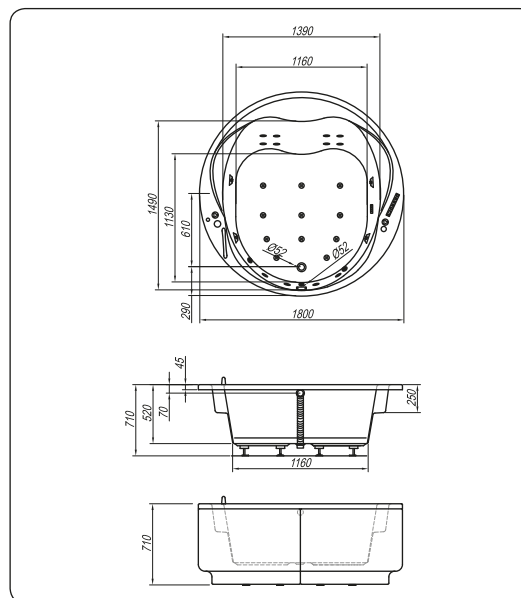

### Opera 180 (Opera 180/O)

	D	Š	VM	Vol.
Opera 180 × 180	1800	1800	520	720 l

#### Masažni sistem VITAL:

- zračna crpka
- vodena crpka
- 4 super vodenih mlaznica
- 11 zračnih mlaznica
- 4 dodatne vodene mikro-mlaznice
- 8 vodenih mikro-mlaznica s preklopnikom
- regulator protoka zraka min-max
- elektronički prekidač za vodenu i zračnu crpku
- senzor za nivo vode
- svjetlo s chromoterapijom
- ozon
- intervalna regulacija za vodu, zrak i svjetlo
- oscilirajuća regulacija za vodu i zrak
- grijač za održavanje temperature vode
- programiranje željene temperature vode
- odljevno-preljevna garnitura
- podnožje kade za kupanje
- obloga kade za kupanje (za određene modele)

#### Vodeni masažni sistem II

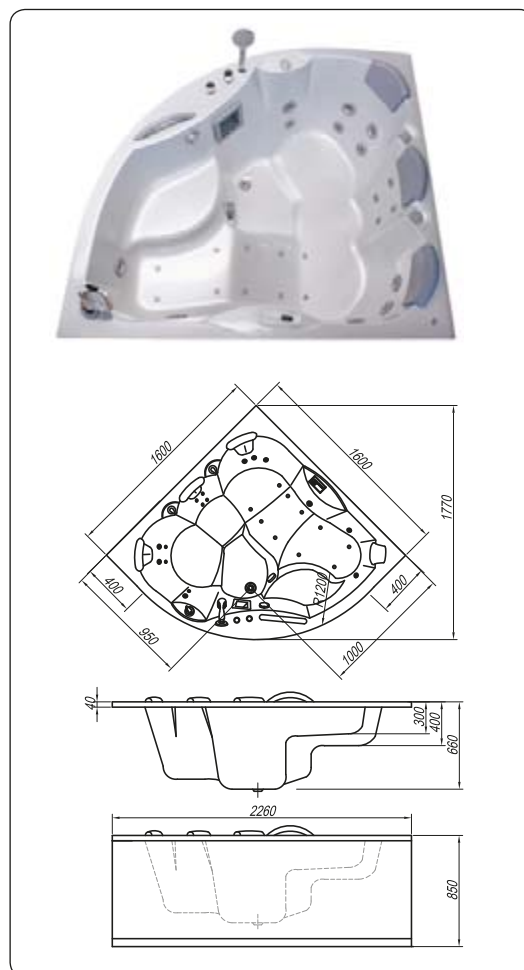

**Gaia 160 (Gaia 160/O)**

	D	Š	VM	Vol.
Gaia 160 × 160	1600	1600	660	550 l

**Masažni sistem LUXUS +:**

- vodena crpka
  - zračna crpka
  - elektronički prekidač za vodenu i zračnu crpku, svjetlo, chromoterapijo, filtriranje i grijanje vode
  - grijač za održavanje temperature vode
  - 2x regulatora protoka zraka min-max
  - programiranje željene temperature vode
  - ugrađen filter za filtraciju vode
  - svjetlo s chromoterapijom
  - senzor za nivo vode
  - vodene mikro-mlaznice s preklopnikom
  - 10 zračnih mlaznica
  - 8 vodenih super mlaznica
  - 7 vodenih mikro-mlaznica
  - 3 naslona za glavu
  - odlivno prelivna garnitura
  - podnožje kade za kupanje
  - armatura s tuš ručkom
- obloga masažne kade
  - stepenica
  - laser boja

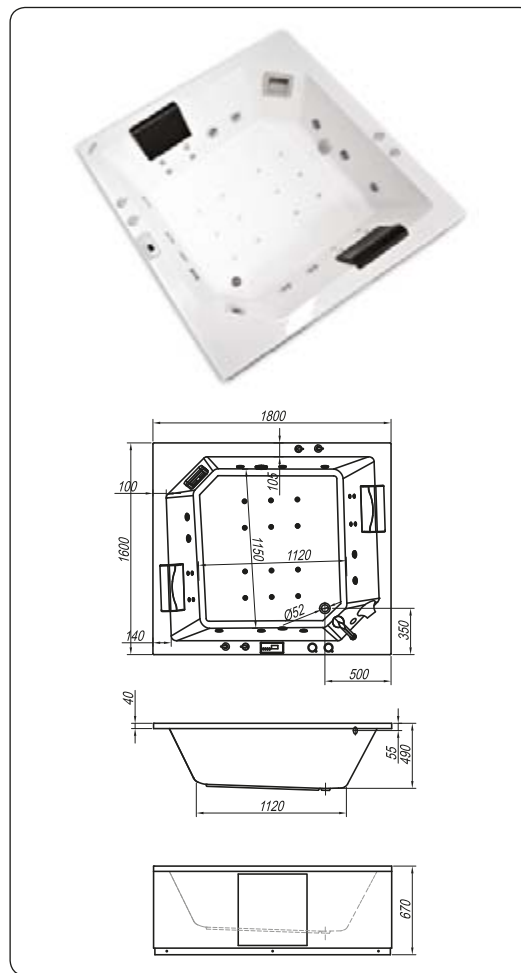

### Samson 180 (Samson 180/O)

	D	Š	VM	Vol.
Samson 180 x 160	1800	1600	490	650 l

#### Masažni sistem LUXUS +:

- vodena crpka
  - zračna crpka
  - elektronički prekidač za vodenu i zračnu crpku, svjetlo, chromoterapija, filtriranje i grijanje vode
  - grijač za održavanje temperature vode
  - 2x regulatora protoka zraka min-max
  - programiranje željene temperature vode
  - ugrađen filtar za filtraciju vode
  - svjetlo s chromoterapijom
  - senzor za razinu vode
  - 8 mikro vodenih mlaznica
  - 12 zračnih mlaznica
  - 8 vodnih super mlaznica
  - 2 prekidača za mikro-mlaznice
  - odlivno prelivna garnitura
  - podnožje kade za kupanje
- obloga masažne kade
  - armatura s tuš ručkom
  - naslon za glavu (SAM)

Šifra Vokel	Opis
0403371	SAMSON 180/40 LUXUS + BATERIJA
0403428	SAMSON 180/40 KOMBINIRANA MASAŽA
0403358	SAMSON 180/40 LUXUS + MASAŽA
0403357	SAMSON 180/O LUXUS + MASAŽA
0403374	SAMSON 180x160 LUXUS + MASAŽA + BATERIJA

# Masažne kabine / Masažni paneli





## Masažne kabine

	Mignon 128		Melba 100			Aria 90 Quat		
	M6		M5	M6	M3Q	A0	A3	
Ručni tuš	•		•	•	•	•	•	
Tuš za glavu	•		•	•	•			•
Vodena masaža gornjeg dijela tijela	•		•	•	•			•
Vodena masaža donjeg dijela tijela	•		•	•	•			•
Vodena masaža sa šest mlaznica						•		
Vodene mlaznice za masažu leđa			•	•	•			•
Turska parna sauna	•		•	•	•			•
Regulacija vremena i temperature turske saune	•		•	•				
Alarm	•		•	•				
Sat	•		•	•				
Svjetlo u kabini	•		•	•				
Kromoterapija	•		•	•				
Posudica za eterična ulja – aromaterapija	•			•				
Radio	•			•	•			

	Mignon 128		Melba 100			Aria 90 Quat	
	M6		M5	M6	M3Q	A0	A3
USB priključak za MP3	•			•			
Ozon	•			•			
Sjedalo	•		•	•	•	•	•
Više funkcijska termostatska armatura	•		•	•			
Više funkcijska armatura					•	•	•
Ogledalo			•	•	•	•	•
Vješalica			•	•	•		
OPCIJE:							
Radio						•	•



## Kromoterapija

Suvremeno dizajniranim proizvodima dodali smo blagotvorne učinke terapije bojama.

Svjetlost i boje utječu na dobro raspoloženje. Počeci kromoterapije sežu u stari Egipat. Pomoću nje se postiže ravnoteža u tijelu i jačaju učinci obnavljanja. Svaka boja utječe drugačije: crvena, narančasta i žuta potiču vitalnost, plava, zelena i ljubičasta oslobađaju i smiruju. Prepletanje utjecaja vode i boja omogućuje opuštanje tijela i duha. Voda ispire napetost i umor, a boje smiruju, jačaju i oživljuju.

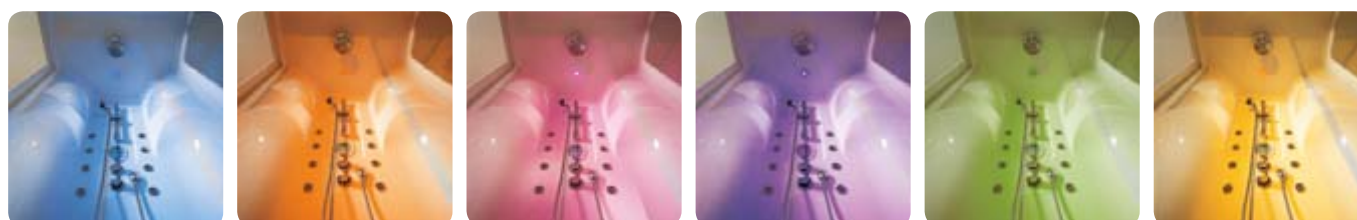

Parna odn. turska sauna jedan je najstarijih oblika opuštanja i čišćenja tijela, a njena pravilna upotreba poboljšava psihofizičko stanje. Danas saunu upotrebljavamo ponajprije zbog smanjivanja stresa i čišćenja tijela, opuštanja, jačanja imuniteta, poboljšavanja cirkulacije i detoksikacije tijela. Radi visokog stupnja vlage i posebno uz upotrebu aromaterapije, parna sauna pozitivno utječe i na dišne putove.

Kolpini savjeti za pravilnu upotrebu parne saune: Saunu nije preporučljivo upotrebljavati odmah nakon obroka. Prije upotrebe tijelo zagrijte vježbama za istezanje. Prije i nakon upotrebe saune istuširajte se mlačnom vodom. Nakon saune se opustite jer tako produžavate umirujući osjećaj kojeg je stvorila toplina. Također, važno je da nadoknadite gubitak tekućine i mineralnih soli i zato prije i nakon saune pijte vodu, čaj ili prirodne sokove.

## Parna sauna



## MIGNON 128 -L, -D

128 × 100 × 227,5

Masažna kabina s parnom saunom:  
M6.

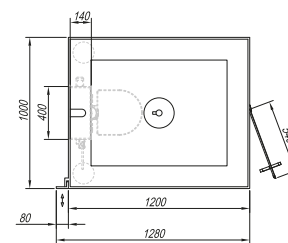
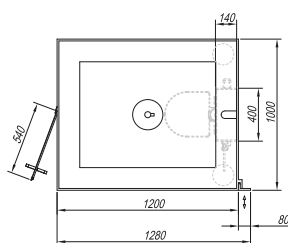
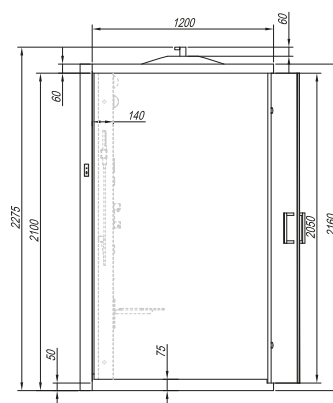
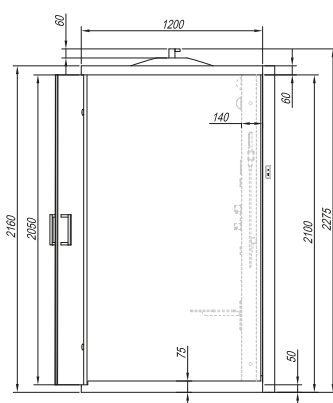

S. Vokel 0403426

Mignon 128 -L

S. Vokel

Mignon 128 -D





## MELBA 100

100 × 100 × 228

Š. Vokel / 0403362

Masažna kabina s parnom saunom M5.



Š. Vokel / 0403370

Masažna kabina s parnom saunom M6.



Š. Vokel /

Masažna kabina s parnom saunom M3Q.





## NOTUS 2200 5f

35 x 220

### Funkcija sustava:

- velika prha za glavo
- masaža zgornjega dela telesa z dvema šobama
- masaža spodnjega dela telesa z dvema šobama
- termostatska armatura 5F
- ročna prha
- zložljiv sedež (bele barve)
- slap
- vgradnja - stenska
- 5 različnih Kerrock barv

### Funkcija sustava:

- veliki tuš za glavu
- masaža gornjeg dijela tijela s dvije mlaznice
- masaža donjeg dijela tijela s dvije mlaznice
- termostatska armatura 5F
- ručni tuš
- preklopno sjedalo (bijele boje)
- slap
- ugradnja zidna
- 5 različitih Kerrock boja

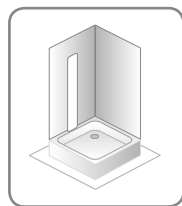

109 bijela

1087dolomite grain

5194 rhyolite

9017 stardust

Š. Vokel / 0403423

9070 graphite



### • KERROCK

Boje masažnog panela

## NOTUS 1400 5f

35 x 140

### Funkcija sustava:

- veliki tuš za glavu
- masaža gornjeg dijela tijela s dvije mlaznice
- masaža donjeg dijela tijela s dvije mlaznice
- termostatska armatura 5F
- ručni tuš
- slap
- ugradnja zidna
- 5 različitih Kerrock boja

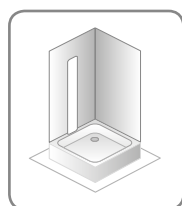

Š. Vokel / 0403421

109 bijela

1087dolomite grain

5194 rhyolite

9017 stardust

Š. Vokel / 0403417

9070 graphite



### • KERROCK

Boje masažnog panela

## Zonda 1500 3f

22 x 150

### Funkcija sustava:

- tuš za glavu
- masaža gornjeg dijela tijela
- masaža donjeg dijela tijela
- 3 funkcijska armatura
- ručni tuš
- slap
- ugradnja zidna
- 5 različitih Kerrock boja

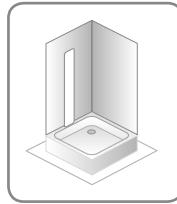

Š. Vokel / 0403432

109 bijela

1087 dolomite grain

5194 rhyolite

9017 stardust

Š. Vokel / 0403436

9070 graphite



### • KERROCK

Boje masažnog panela

## MISTRAL 1200 3f NEW

35 x 120

### Funkcija sustava:

- masaža gornjeg dijela tijela s dvije mlaznice
- masaža donjeg dijela tijela s dvije mlaznice
- ručni tuš na konzoli
- vješalica
- 3 funkcijska armatura
- ugradnja – zidna
- 5 različitih Kerrock boja

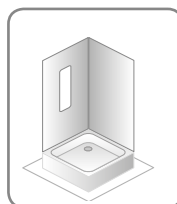

Š. Vokel / 0403418

109 bijela

1087 dolomite grain

5194 rhyolite

9017 stardust

9070 graphite



### • KERROCK

Boje masažnog panela

## DIABLO 1700 3f

18 × 170

Š. Vokel 0403419

**INOX - ispoliran do visokog sjaja**

**Funkcije sustava:**

- tuš za glavu
- masaža gornjeg dijela tijela
- masaža donjeg dijela tijela
- 3 funkcijska armatura
- ručni tuš
- ugradnja: zidna

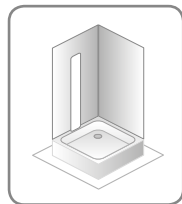

## DIABLO 1550 2f

23 × 155

Š. Vokel 0403433

**INOX - ispoliran do visokog sjaja**

**Funkcije sustava:**

- tuš za glavu
- 2 funkcijska armatura
- ručni tuš
- ugradnja: zidna

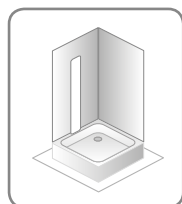

## BORA 1420 3f

18,5 × 142

Š. Vokel / 0403416

ALUMINIJ - matirani, sive boje

Funkcije sustava:

- tuš za glavu
- masaža gornjeg dijela tijela
- masaža donjeg dijela tijela
- 3 funkcijska armatura
- ručni tuš
- ugradnja: kutna, zidna

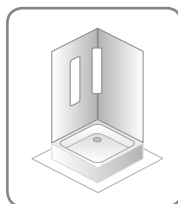

## ARIA 90 QUAT

90 × 90 × 226

Š. Vokel / 0403215

Masažna kabina – masažni sistem A0

Š. Vokel / 0403321

Masažna kabina – masažni sistem A3

Š. Vokel / 0403372

Masažna kabina – masažni sistem A3 + RADIO



# Tuš kabine







 **Terra**

8 mm kaljeno prozirno staklo	
Silver Brill profili (visokopolirana srebrna galvanska prevlaka)	
Zatvaranje s magnetskim profilom	
Kromirane šarke s podiznom funkcijom	
Dodatni nosači	
Kromirane šarke utisnute u staklo na unutarnjoj strani kabine omogućuju lakše čišćenje	
Dodatni aluminijski profil na tuš kadi sprječava istjecanje vode	

Terra			A	B						nanosan
Terra <b>TKK 90</b>			88 - 89	86,5 - 87,5	195	75				
Terra <b>TKK 100</b>			98 - 99	96,5 - 97,5	195	75				
Terra <b>TKP 90</b>			88 - 89	86,5 - 87,5	195	86	55			
Terra <b>TKP 100</b>			98 - 99	96,5 - 97,5	195	86	55			
Terra <b>TV/S 90 -L, -D</b>			88 - 90	88 - 90	195	53				
Terra <b>TV/S 100 -L, -D</b>			98 - 100	98 - 100	195	53				
Terra <b>TV 90 -L, D</b>			88 - 89	86,5 - 87,5	195	53				
Terra <b>TSv 80</b>			78 - 79	76,5 - 77,5	195	53				
Terra <b>TSv 90</b>			88 - 89	86,5 - 87,5	195	53				



Terra **TKK** 90, 100

Canary, Haka, Rock, Trin, Boston, Beat, Flamenco, Salsa, Step zero, Lerock zero, Horon, Vals

Š.Vokel	Opis
<b>0405670</b>	TUŠ KABINA TERRA TTK 90/K
<b>0405665</b>	TUŠ KABINA TERRA TTK 100/K

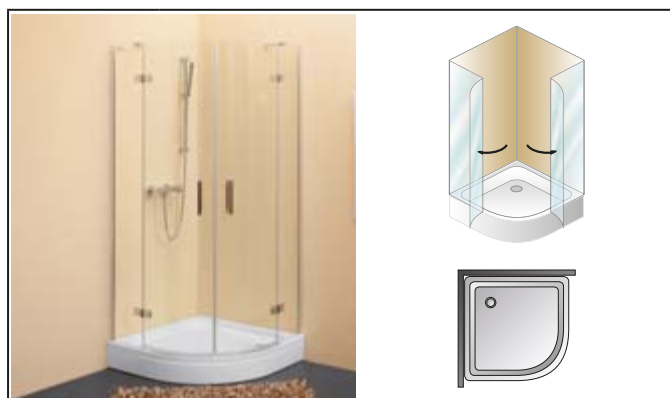

Terra **TKP** 90, 100

Macarena, Bebop, Ontex, Eisa, Blues, Dixie, Bossanova, Pony

Š.Vokel	Opis
<b>0405668</b>	TUŠ KABINA TERRA TKP 90/K
<b>0405598</b>	TUŠ KABINA TERRA TKP 100/K

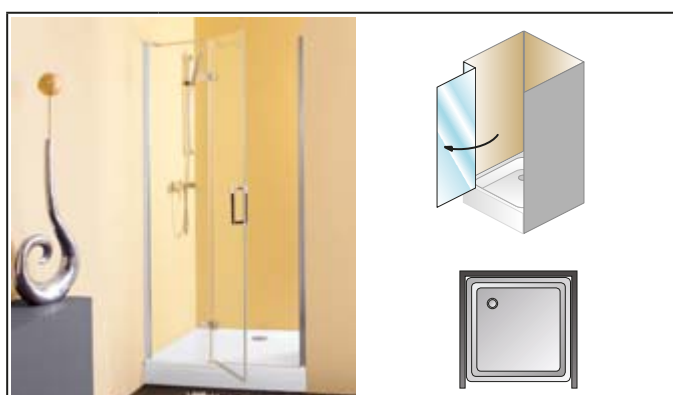

Terra **TV/S** 90, 100 -L

Samba, Canary, Haka, Ska, Rock, Trin, Boston, Beat, Flamenco, Vip, Bono, Salsa, Horon, Lerock zero, Step zero, Vals

Š.Vokel	Opis
<b>0405663</b>	TUŠ VRATA TERRA TVS 90/K LIJEVA
<b>0405672</b>	TUŠ VRATA TERRA TVS 100/K LIJEVA

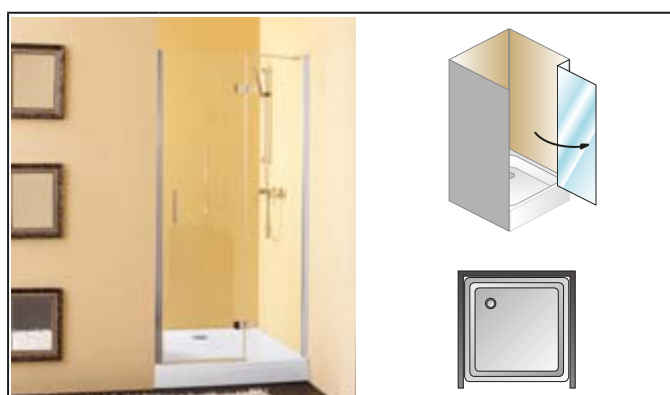

Terra **TV/S** 90, 100 -D

Samba, Canary, Haka, Ska, Rock, Trin, Boston, Beat, Flamenco, Vip, Bono, Salsa, Horon, Lerock zero, Step zero, Vals

Š.Vokel	Opis
<b>0405664</b>	TUŠ VRATA TERRA TVS 90/K DESNA
<b>0405678</b>	TUŠ VRATA TERRA TVS 100/K DESNA



Terra **TV** 90 -L, + TSv 80, 90

Canary, Haka, Ska, Rock, Trin, Boston, Flamenco, Horon, Salsa, Beat, Vals

Š.Vokel	Opis
<b>0405667</b>	TUŠ VRATA TERRA TV 90/K LIJEVA
<b>0405666</b>	TUŠ STJENKA TERRA TSv 80/K
<b>0405662</b>	TUŠ STJENKA TERRA TSv 90/K



Terra **TV** 90 -D, + TSv 80, 90

Canary, Haka, Ska, Rock, Trin, Boston, Flamenco, Horon, Salsa, Beat, Vals

Š.Vokel	Opis
<b>0405661</b>	TUŠ VRATA TERRA TV 90/K DESNA
<b>0405666</b>	TUŠ STJENKA TERRA TSv 80/K
<b>0405662</b>	TUŠ STJENKA TERRA TSv 90/K





 **Terra flat**

6 mm kaljeno prozirno staklo



Silver Brill profili (visokopolirana srebrna galvanska prevlaka)



Zatvaranje s magnetskim profilom



Kromirane šarke s podiznom funkcijom



Kromirane šarke utisnute u staklo na unutarnjoj strani kabine omogućuju lakše čišćenje



Dodatni aluminijski profil na tuš kadi sprječava istjecanje vode

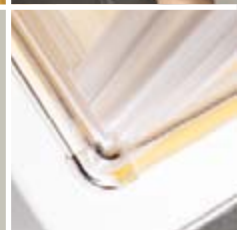

Terra FLAT										nanosan
Terra FLAT <b>TKK 90</b>			88,5 x 89,5	87 - 88	200	111				
Terra FLAT <b>TKK 100</b>			98,5 x 99,5	97 - 98	200	125				
Terra FLAT <b>TV/S 70 -L, D</b>			68 x 70	68 x 70	200	55				
Terra FLAT <b>TV/S 80 -L, -D</b>			78 x 80	78 x 80	200	65				
Terra FLAT <b>TV/S 90 -L, -D</b>			88 - 90	88 x 90	200	75				





Terra flat **TKK** 90, 100

Canary, Haka, Salsa, Rock, Trin, Boston, Beat, Flamenco, Step zero, Lerock zero, Horon, Vals



Š.Vokel	Opis
<b>0405747</b>	TUŠ KABINA TERRA FLAT TTK 90/K
<b>0405748</b>	TUŠ KABINA TERRA FLAT TTK 100/K



Terra flat **TV/S** 70, 80, 90 -L

Lerock zero, Bono, Vip, Canary, Flamenco, Salsa, Haka, Rock, Boston, Beat, Ska, Horon, Trin, Vals



Š.Vokel	Opis
	TUŠ VRATA TERRA FLAT TV/S 70/K LIJEVA
<b>0405761</b>	TUŠ VRATA TERRA FLAT TV/S 80/K LIJEVA
<b>0405749</b>	TUŠ VRATA TERRA FLAT TV/S 90/K LIJEVA



Terra flat **TV/S** 70, 80, 90 -D

Lerock zero, Bono, Vip, Canary, Flamenco, Salsa, Haka, Rock, Boston, Beat, Ska, Horon, Trin, Vals



Š.Vokel	Opis
<b>0405812</b>	TUŠ VRATA TERRA FLAT TV/S 70/K DESNA
<b>0405811</b>	TUŠ VRATA TERRA FLAT TV/S 80/K DESNA
	TUŠ VRATA TERRA FLAT TV/S 90/K DESNA

Opcije:

Mogućnost narudžbe tuš kabina, vrata i stjenki sa NANO SAN premazom.





 **Corona**

8 mm kaljeno prozirno staklo

6 mm kaljeno prozirno staklo - TS OPEN 90, 100, PS 72, 82

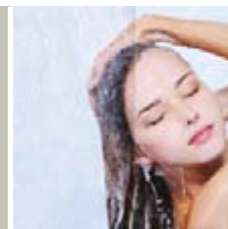

Silver Brill profili (visokopolirirana srebrna galvanska prevlaka)

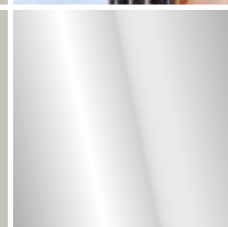

Zatvaranje s magnetskim profilom

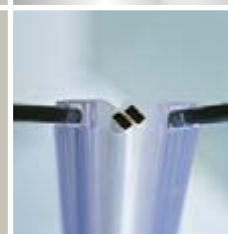

Kromirane šarke utisnute u staklo na unutarnjoj strani kabine omogućuju lakše čišćenje



Dodatni aluminijski profil na tuš kadi sprječava istjecanje vode

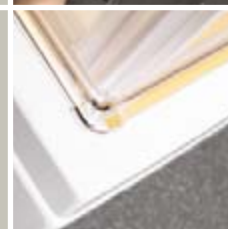

Corona			A	B					nanosan
Corona TK 120x80 -L, -D			118-119x78-79	76,5 - 77,5	200(204)	60			
Corona TK 120x90 -L, -D			118-119x88-89	86,5 - 87,5	200(204)	60			
Corona TK 140x90 -L, -D			138-139x88-89	86,5 - 87,5	200(204)	60			
Corona TV/S 120 -L, -D			117 - 120		200(204)	60			
Corona TV/S 130 -L, -D			127 - 130		200(204)	60			
Corona TV/S 140 -L, -D			137 - 140		200(204)	60			
Corona TK OPEN 120x80, 140x80			116/136x77,5-78,5		200(204)	77			
Corona TK OPEN 120x90, 140x90			116/136x87,5-88,5		200(204)	87			
Corona TS OPEN 90, 100					200(204)		88,5   98,5		
Corona TS OPEN 120, 140					200(204)		118   138		
Corona TS 28 OPEN					200(204)		28		
Corona PS 72					185		71,5 - 72		
Corona PS 82					185		81,5 - 82		
Corona TP 92 Grazia					150		92		



Corona TK 120x80, 120x90, 140x90 -L

Canary, Lerock zero, Vip, Bono, Salsa, Haka, Flamenco, Vals

Š.Vokel	Opis
	TUŠ KABINA CORONA TK 120x80/K LIJEVA
<b>0405511</b>	TUŠ KABINA CORONA TK 120x90/K LIJEVA
<b>0405500</b>	TUŠ KABINA CORONA TK 140x90/K LIJEVA



Corona TK 120x80, 120x90, 140x90 -D

Canary, Lerock zero, Vip, Bono, Salsa, Haka, Flamenco, Vals

Š.Vokel	Opis
	TUŠ KABINA CORONA TK 120x80/K DESNA
<b>0405463</b>	TUŠ KABINA CORONA TK 120x90/K DESNA
<b>0405456</b>	TUŠ KABINA CORONA TK 140x90/K DESNA



Corona TV/S 120/K, 130/K, 140/K-L

Lerock zero, Vip, Bono, Canary, Salsa, Haka, Flamenco, Vals

Š.Vokel	Opis
	TUŠ VRATA CORONA TV/S 120/K LIJEVA
<b>0405324</b>	TUŠ VRATA CORONA TV/S 130/K LIJEVA
<b>0405360</b>	TUŠ VRATA CORONA TV/S 140/K LIJEVA



Corona TV/S 120/K, 130/K, 140/K-D

Lerock zero, Vip, Bono, Canary, Salsa, Haka, Flamenco, Vals

Š.Vokel	Opis
<b>0405396</b>	TUŠ VRATA CORONA TV/S 120/K DESNA
<b>0405325</b>	TUŠ VRATA CORONA TV/S 130/K DESNA
<b>0405660</b>	TUŠ VRATA CORONA TV/S 140/K DESNA



Corona TK OPEN 120 x 80, 120 x 90, 140 x 80, 140 x 90

Lerock zero, Vip, Bono, Canary, Flamenco, Salsa, Haka, Vals

Š.Vokel	Opis
<b>0405760</b>	TUŠ KABINA CORONA TK OPEN 120x80/K
<b>0405754</b>	TUŠ KABINA CORONA TK OPEN 120x90/K
	TUŠ KABINA CORONA TK OPEN 140x80/K
<b>0405546</b>	TUŠ KABINA CORONA TK OPEN 140x90/K



Corona TK OPEN 120 x 80, 120 x 90, 140 x 80, 140 x 90 + TS OPEN 28

Lerock zero, Vip, Bono, Canary, Flamenco, Salsa, Haka, Vals

Š.Vokel	Opis
<b>0405742</b>	TUŠ STJENKA CORONA TS OPEN 28
DODATNA TUŠ STJENKA ZA KOMBINACIJU S TK OPEN I TS OPEN 120, 140	





Corona **TS OPEN** 120, 140 (stabilizator L = max 120 cm)

Lerock zero, Vip, Bono, Canary, Flamengo, Salsa, Haka, Vals



Š.Vokel	Opis
0405508	TUŠ STJENKA CORONA TS OPEN 120/K
0405507	TUŠ STJENKA CORONA TS OPEN 140/K



Corona **TS OPEN** 90, 100 (stabilizator L= max 100 cm)

Canary, Salsa, Haka, Rock, Trin, Boston, Beat, Flamengo, Step zero, Lerock zero, Horon, Vip, Ska, Vals



Š.Vokel	Opis
0405681	TUŠ STJENKA CORONA TS OPEN 90/K
0405682	TUŠ STJENKA CORONA TS OPEN 100/K



Corona **TS OPEN** 120, 140 + **TS OPEN** 28 (stabilizator L= max 120 cm)

Lerock zero, Vip, Bono, Canary, Salsa, Flamengo, Haka, Vals



Š.Vokel	Opis
0405508	TUŠ STJENKA CORONA TS OPEN 120/K
0405507	TUŠ STJENKA CORONA TS OPEN 140/K
0405742	TUŠ STJENKA CORONA TS OPEN 28



Corona **PS** 72, 82



Š.Vokel	Opis
0405803	PREGRADNA STJENKA CORONA PS 72/K
0405804	PREGRADNA STJENKA CORONA PS 82/K



Sole **TP 92 GRAZIA-D**

Grazia-D



Š.Vokel	Opis
0405755	TUŠ PARAVAN SOLE TP 92/K GRAZIA

Opcije:

Mogućnost narudžbe tuš kabina, vrata i stjenki sa NANO SAN premazom.



Mogućnost montaže na slijedeće tuš kade



Mogućnost montaže na navedene kupaonske kade





 **Virgo**

8 mm kaljeno prozorno staklo



Silver Brill profili (visokopolirirana srebrna galvanska prevlaka)

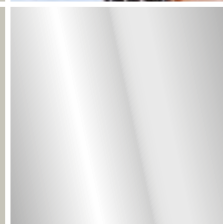

Zatvaranje s magnetskim profilom



Dodatni aluminjski profil na tuš kadi sprječava istjecanje vode



Virgo								nanosan
Virgo TK 120x80 -L, -D			118,5 - 119 x 79 - 80	200	460			
Virgo TK 120x90 -L, -D			118,5 - 119 x 89 - 90	200	460			
Virgo TK 140x80 -L, -D			138,5 - 139 x 79 - 80	200	560			
Virgo TK 140x90 -L, -D			138,5 - 139 x 89 - 90	200	560			
Virgo TK 160x80 -L, -D			158,5 - 159 x 79 - 80	200	660			
Virgo TK 160x90 -L, -D			158,5 - 159 x 89 - 90	200	660			
Virgo TV2D/S 120 -L, -D			119 - 120	200	460			
Virgo TV2D/S 140 -L, -D			139 - 140	200	560			
Virgo TV2D/S 160 -L, -D			159 - 160	200	660			



Virgo **TK** 120x80, 120x90, 140x80, 140x90, 160x80, 160x90 -L

Canary, Lerock zero, Vip, Bono, Salsa, Haka, Flamenco, Vals

Š.Vokel	Opis
<b>0405797</b>	TUŠ KABINA VIRGO TK 120x80/K LIJEVA
<b>0405785</b>	TUŠ KABINA VIRGO TK 120x90/K LIJEVA
<b>0405798</b>	TUŠ KABINA VIRGO TK 140x80/K LIJEVA
<b>0405799</b>	TUŠ KABINA VIRGO TK 140x90/K LIJEVA
	TUŠ KABINA VIRGO TK 160x80/K LIJEVA
<b>0405782</b>	TUŠ KABINA VIRGO TK 160x90/K LIJEVA



Virgo **TK** 120x80, 120x90, 140x80, 140x90, 160x80, 160x90 -D

Canary, Lerock zero, Vip, Bono, Salsa, Haka, Flamenco, Vals

Š.Vokel	Opis
<b>0405796</b>	TUŠ KABINA VIRGO TK 120x80/K DESNA
<b>0405773</b>	TUŠ KABINA VIRGO TK 120x90/K DESNA
	TUŠ KABINA VIRGO TK 140x80/K DESNA
<b>0405791</b>	TUŠ KABINA VIRGO TK 140x90/K DESNA
	TUŠ KABINA VIRGO TK 160x80/K DESNA
<b>0405794</b>	TUŠ KABINA VIRGO TK 160x90/K DESNA



Virgo **TV2D/S** 120, 140, 160 -L

Canary, Lerock zero, Vip, Bono, Salsa, Haka, Flamenco, Vals

Š.Vokel	Opis
<b>0405790</b>	TUŠ VRATA VIRGO TV2D/S 120/K LIJEVA
<b>0405789</b>	TUŠ VRATA VIRGO TV2D/S 140/K LIJEVA
	TUŠ VRATA VIRGO TV2D/S 160/K LIJEVA



Virgo **TV2D/S** 120, 140, 160 -D

Canary, Lerock zero, Vip, Bono, Salsa, Haka, Flamenco, Vals

Š.Vokel	Opis
<b>0405775</b>	TUŠ VRATA VIRGO TV2D/S 120/K DESNA
	TUŠ VRATA VIRGO TV2D/S 140/K DESNA
<b>0405792</b>	TUŠ VRATA VIRGO TV2D/S 160/K DESNA





8 mm kaljeno prozorno staklo

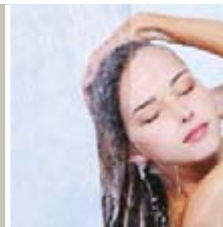

Silver Brill profili (visokopolirana srebrna galvanska prevlaka)

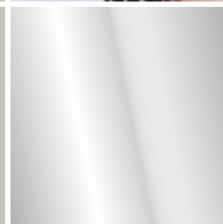

Zatvaranje s magnetskim profilom



Dodatni aluminijски profil na tuš kadi sprječava istjecanje vode



								nanosan
Kronos TK 120x80 -L, -D			118 x 78 - 118,5 x 78,5	200	440			
Kronos TK 120x90 -L, -D			118 x 88 - 118,5 x 88,5	200	440			
Kronos TK 140x80 -L, -D			138 x 78 - 138,5 x 78,5	200	520			
Kronos TK 140x90 -L, -D			138 x 88 - 138,5 x 88,5	200	520			
Kronos TK 160x80 -L, -D			158 x 78 - 158,5 x 78,5	200	620			
Kronos TK 160x90 -L, -D			158 x 88 - 158,5 x 88,5	200	620			
Kronos TV2D/S 120 -L, -D			119 - 120	200	440			
Kronos TV2D/S 140 -L, -D			139 - 140	200	520			
Kronos TV2D/S 160 -L, -D			159 - 160	200	620			





Kronos **TK** 120x80, 120x90, 140x80, 140x90, 160x80, 160x90 -L

Canary, Lerock zero, Vip, Bono, Salsa, Haka, Flamenco, Vals



Š.Vokel	Opis
<b>0405800</b>	TUŠ KABINA KRONOS TK 120x80/K LIJEVA
<b>0405801</b>	TUŠ KABINA KRONOS TK 120x90/K LIJEVA
	TUŠ KABINA KRONOS TK 140x80/K LIJEVA
<b>0405780</b>	TUŠ KABINA KRONOS TK 140x90/K LIJEVA
	TUŠ KABINA KRONOS TK 160x80/K LIJEVA
<b>0405783</b>	TUŠ KABINA KRONOS TK 160x90/K LIJEVA



Kronos **TK** 120x80, 120x90, 140x80, 140x90, 160x80, 160x90 -D

Canary, Lerock zero, Vip, Bono, Salsa, Haka, Flamenco, Vals



Š.Vokel	Opis
	TUŠ KABINA KRONOS TK 120x80/K DESNA
<b>0405778</b>	TUŠ KABINA KRONOS TK 120x90/K DESNA
	TUŠ KABINA KRONOS TK 140x80/K DESNA
<b>0405802</b>	TUŠ KABINA KRONOS TK 140x90/K DESNA
	TUŠ KABINA KRONOS TK 160x80/K DESNA
	TUŠ KABINA KRONOS TK 160x90/K DESNA



Kronos **TV2D/S** 120, 140, 160 -L

Canary, Lerock zero, Vip, Bono, Salsa, Haka, Flamenco, Vals



Š.Vokel	Opis
<b>0405779</b>	TUŠ VRATA KRONOS TV2D/S 120/K LIJEVA
<b>0405795</b>	TUŠ VRATA KRONOS TV2D/S 140/K LIJEVA
	TUŠ VRATA KRONOS TV2D/S 160/K LIJEVA



Kronos **TV2D/S** 120, 140, 160 -D

Canary, Lerock zero, Vip, Bono, Salsa, Haka, Flamenco, Vals



Š.Vokel	Opis
<b>0405774</b>	TUŠ VRATA KRONOS TV2D/S 120/K DESNA
<b>0405793</b>	TUŠ VRATA KRONOS TV2D/S 140/K DESNA S NANO PREMAZOM
	TUŠ VRATA KRONOS TV2D/S 160/K DESNA



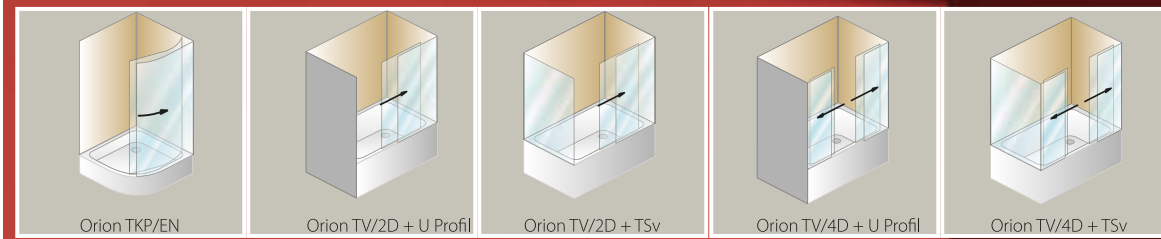

 **Orion**

6 mm kaljeno prozirno staklo	
6 mm chinchilla kaljeno staklo	
Srebrni profili (srebrna galvanska prevlaka)	
Bijeli profili (plastificiranje)	
Zatvaranje s magnetskim profilom	
Mogućnost kompenzacijskog profila K-35	

Orion									nanosan
Orion <b>TKP 80/EN</b>				77 - 79	190	48	55		
Orion <b>TV/2D 120</b>				118 - 120	140	48			
Orion <b>TV/2D 130</b>				128 - 130	140	52			
Orion <b>TV/4D 140</b>				138 - 140	140	55			
Orion <b>TV/4D 150</b>				148 - 150	140	55			
Orion <b>TV/4D 160</b>				158 - 160	140	66			
Orion <b>TV/4D 170</b>				168 - 170	140	73			
Orion <b>TV/4D 180</b>				178 - 180	140	73			
Orion <b>TSv 70</b>				68 - 71	140				
Orion <b>TSv 75</b>				73 - 76	140				
Orion <b>TSv 80</b>				78 - 81	140				

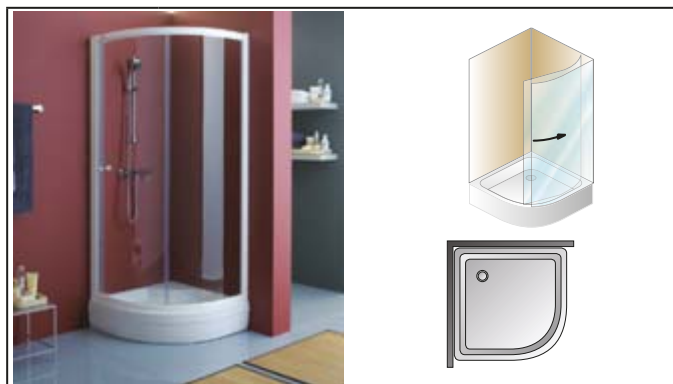

Orion **TKP 80/EN**

Pony, Ontex

Š.Vokel	Opis
<b>0405416</b>	TUŠ KABINA ORION TKP 80/ENCH BIJELO H=190
	TUŠ KABINA ORION TKP 80/ENCH SILVER H=190



Orion **TV/2D 120, 130 + U profil**

Mogućnost montaže na klasične kade širine 120-130 cm

Š.Vokel	Opis
<b>0405423</b>	TUŠ VRATA ORION TV/2D 120/K BIJELO H=140
<b>0405554</b>	TUŠ VRATA ORION TV/2D 120/CH BIJELO H=140
<b>0405377</b>	TUŠ VRATA ORION TV/2D 130/K BIJELO H=140
<b>0405430</b>	TUŠ VRATA ORION TV/2D 130/CH BIJELO H=140
<b>0405559</b>	TUŠ VRATA ORION TV/2D 120/K SILVER H=140
<b>0405555</b>	TUŠ VRATA ORION TV/2D 120/CH SILVER H=140
<b>0405392</b>	TUŠ VRATA ORION TV/2D 130/K SILVER H=140
	TUŠ VRATA ORION TV/2D 130/CH SILVER H=140



Orion **TV/2D 120, 130 + TSv 70, 75, 80**

Mogućnost montaže na klasične kade širine 120-130 cm

Š.Vokel	Opis
<b>0405423</b>	TUŠ VRATA ORION TV/2D 120/K BIJELO H=140
<b>0405554</b>	TUŠ VRATA ORION TV/2D 120/CH BIJELO H=140
<b>0405377</b>	TUŠ VRATA ORION TV/2D 130/K BIJELO H=140
<b>0405430</b>	TUŠ VRATA ORION TV/2D 130/CH BIJELO H=140
<b>0405424</b>	TUŠ STJENKA ORION TSV 70/K BIJELO H=140
<b>0405408</b>	TUŠ STJENKA ORION TSV 70/CH BIJELO H=140
<b>0405403</b>	TUŠ STJENKA ORION TSV 75/K BIJELO H=140
<b>0405445</b>	TUŠ STJENKA ORION TSV 75/CH BIJELO H=140
<b>0405486</b>	TUŠ STJENKA ORION TSV 80/K BIJELO H=140
<b>0405400</b>	TUŠ STJENKA ORION TSV 80/CH BIJELO H=140
<b>0405559</b>	TUŠ VRATA ORION TV/2D 120/K SILVER H=140
<b>0405555</b>	TUŠ VRATA ORION TV/2D 120/CH SILVER H=140
<b>0405392</b>	TUŠ VRATA ORION TV/2D 130/K SILVER H=140
	TUŠ VRATA ORION TV/2D 130/CH SILVER H=140
<b>0405415</b>	TUŠ STJENKA ORION TSV 70/K SILVER H=140
<b>0405481</b>	TUŠ STJENKA ORION TSV 70/CH SILVER H=140
	TUŠ STJENKA ORION TSV 75/K SILVER H=140
<b>0405438</b>	TUŠ STJENKA ORION TSV 75/CH SILVER H=140
<b>0405503</b>	TUŠ STJENKA ORION TSV 80/K SILVER H=140
<b>0405478</b>	TUŠ STJENKA ORION TSV 80/CH SILVER H=140

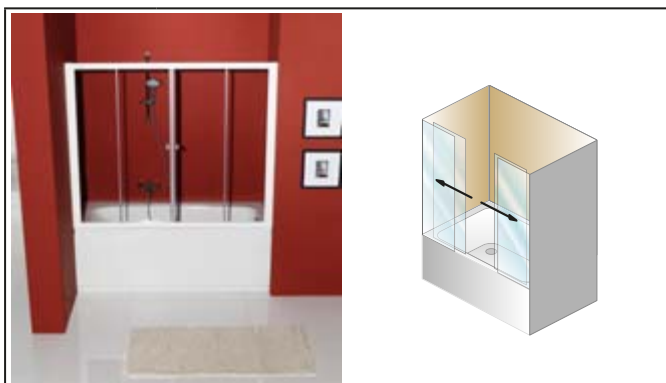

Orion **TV/4D 140, 150, 160, 170, 180 + U profil**

Mogućnost montaže na klasične kade širine 140-180 cm

Š.Vokel	Opis
<b>0405412</b>	TUŠ VRATA ORION TV/4D 140/K BIJELO H=140
<b>0405442</b>	TUŠ VRATA ORION TV/4D 140/CH BIJELO H=140
<b>0405513</b>	TUŠ VRATA ORION TV/4D 150/K BIJELO H=140
<b>0405498</b>	TUŠ VRATA ORION TV/4D 150/CH BIJELO H=140
<b>0405387</b>	TUŠ VRATA ORION TV/4D 160/K BIJELO H=140
<b>0405474</b>	TUŠ VRATA ORION TV/4D 160/CH BIJELO H=140
<b>0405426</b>	TUŠ VRATA ORION TV/4D 170/K BIJELO H=140
<b>0405407</b>	TUŠ VRATA ORION TV/4D 170/CH BIJELO H=140
<b>0405431</b>	TUŠ VRATA ORION TV/4D 180/K BIJELO H=140
<b>0405399</b>	TUŠ VRATA ORION TV/4D 180/CH BIJELO H=140
<b>0405515</b>	TUŠ VRATA ORION TV/4D 140/K SILVER H=140
	TUŠ VRATA ORION TV/4D 140/CH SILVER H=140
<b>0405501</b>	TUŠ VRATA ORION TV/4D 150/K SILVER H=140
<b>0405437</b>	TUŠ VRATA ORION TV/4D 150/CH SILVER H=140
<b>0405394</b>	TUŠ VRATA ORION TV/4D 160/K SILVER H=140
<b>0405480</b>	TUŠ VRATA ORION TV/4D 160/CH SILVER H=140
	TUŠ VRATA ORION TV/4D 170/K SILVER H=140
<b>0405414</b>	TUŠ VRATA ORION TV/4D 170/CH SILVER H=140
<b>0405517</b>	TUŠ VRATA ORION TV/4D 180/K SILVER H=140
<b>0405552</b>	TUŠ VRATA ORION TV/4D 180/CH SILVER H=140





Š.Vokel	Opis
0405389	U-PROFIL TV/2D,4D ORION BIJELO H=140
0405395	U-PROFIL TV/2D,4D ORION SILVER H=140
0405388	K-35 KOMP.PROFIL ZA TV/2D,4D BIJELO H=140
0405413	K-35 KOMP.PROFIL ZA TV/2D,4D SILVER H=140



Š.Vokel	Opis
0405412	TUŠ VRATA ORION TV/4D 140/K BIJELO H=140
0405442	TUŠ VRATA ORION TV/4D 140/CH BIJELO H=140
0405513	TUŠ VRATA ORION TV/4D 150/K BIJELO H=140
0405498	TUŠ VRATA ORION TV/4D 150/CH BIJELO H=140
0405387	TUŠ VRATA ORION TV/4D 160/K BIJELO H=140
0405474	TUŠ VRATA ORION TV/4D 160/CH BIJELO H=140
0405426	TUŠ VRATA ORION TV/4D 170/K BIJELO H=140
0405407	TUŠ VRATA ORION TV/4D 170/CH BIJELO H=140
0405431	TUŠ VRATA ORION TV/4D 180/K BIJELO H=140
0405399	TUŠ VRATA ORION TV/4D 180/CH BIJELO H=140
0405424	TUŠ STJENKA ORION TSV 70/K BIJELO H=140
0405408	TUŠ STJENKA ORION TSV 70/CH BIJELO H=140
0405403	TUŠ STJENKA ORION TSV 75/K BIJELO H=140
0405445	TUŠ STJENKA ORION TSV 75/CH BIJELO H=140
0405486	TUŠ STJENKA ORION TSV 80/K BIJELO H=140
0405400	TUŠ STJENKA ORION TSV 80/CH BIJELO H=140
0405515	TUŠ VRATA ORION TV/4D 140/K SILVER H=140
	TUŠ VRATA ORION TV/4D 140/CH SILVER H=140
0405501	TUŠ VRATA ORION TV/4D 150/K SILVER H=140
0405437	TUŠ VRATA ORION TV/4D 150/CH SILVER H=140
0405394	TUŠ VRATA ORION TV/4D 160/K SILVER H=140
0405480	TUŠ VRATA ORION TV/4D 160/CH SILVER H=140
	TUŠ VRATA ORION TV/4D 170/K SILVER H=140
0405414	TUŠ VRATA ORION TV/4D 170/CH SILVER H=140
0405517	TUŠ VRATA ORION TV/4D 180/K SILVER H=140
0405552	TUŠ VRATA ORION TV/4D 180/CH SILVER H=140
0405415	TUŠ STJENKA ORION TSV 70/K SILVER H=140
0405481	TUŠ STJENKA ORION TSV 70/CH SILVER H=140
	TUŠ STJENKA ORION TSV 75/K SILVER H=140
0405438	TUŠ STJENKA ORION TSV 75/CH SILVER H=140
0405503	TUŠ STJENKA ORION TSV 80/K SILVER H=140
0405478	TUŠ STJENKA ORION TSV 80/CH SILVER H=140







6 mm kaljeno prozirno staklo

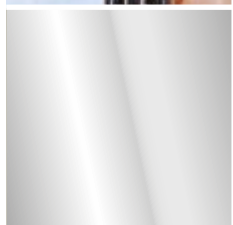

Silver Brill profili (visokopolirana srebrna galvanska prevlaka)

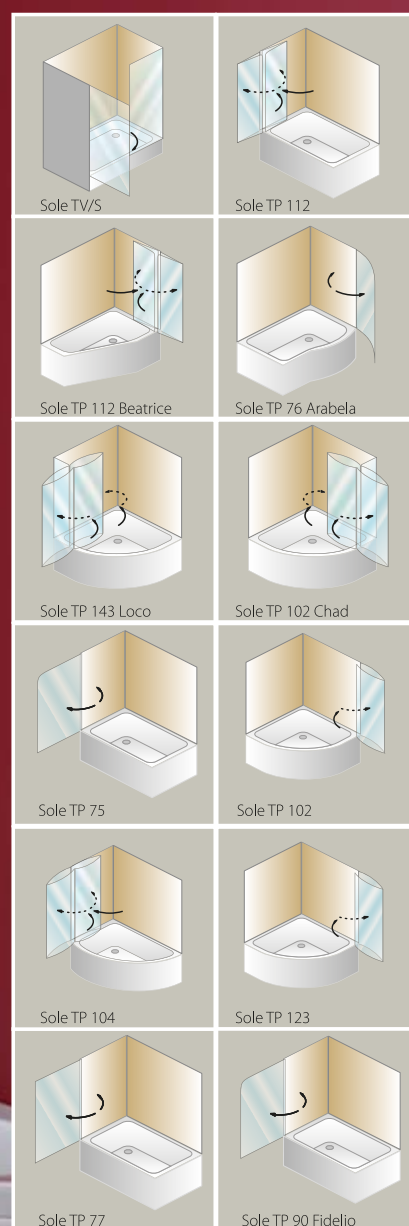

**Sole**

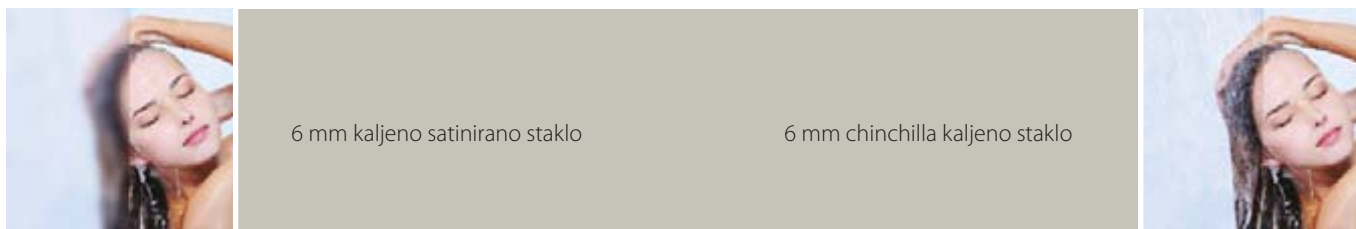

6 mm kaljeno satinirano staklo

6 mm chinchilla kaljeno staklo

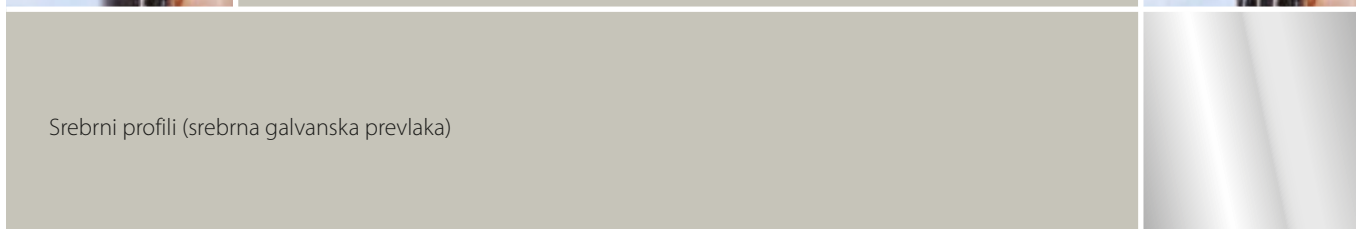

Srebrni profili (srebrna galvanska prevlaka)



Bijeli profili (plastificiranje)



Zatvaranje s magnetskim profilom

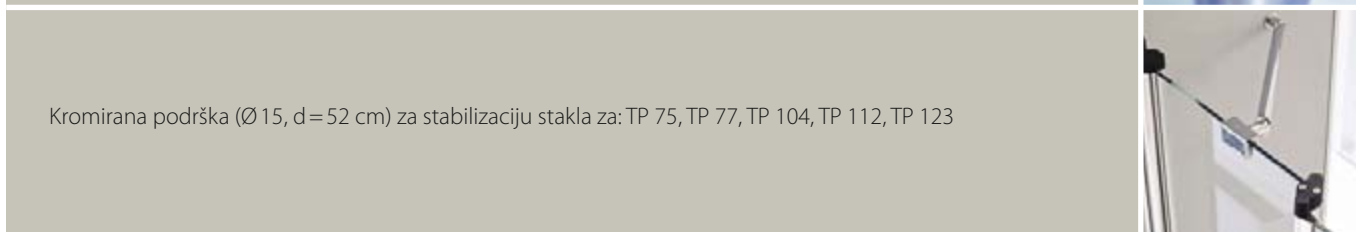

Kromirana podrška (Ø 15, d=52 cm) za stabilizaciju stakla za: TP 75, TP 77, TP 104, TP 112, TP 123



Sole								nanosan
Sole TV/S 100 -L,-D								
Sole TV/S 130 -L,-D								
Sole TP 112 -L,-D								
Sole TP 112 Beatrice -L,-D								
Sole TP 102 Allegro, Royal, Divante -L,-D								
Sole TP 102 Chad -L,-D								
Sole TP 104 Lulu, Calando -L,-D								
Sole TP 123 Largo, Alba -L,-D								
Sole TP 143 Loco -L,-D								
Sole TP 90 Fidelio -L,-D								
Sole TP 75								
Sole TP 77								
Sole TP 80 Arabela -L,-D								

Sole **TV/S 100, 130 -L**

Salsa, Canary, Haka, Flamenco, Boston, Rock, Step zero, Lerock zero

Š.Vokel	Opis
<b>0405759</b>	TUŠ VRATA TV/S 100/K LIJEVA
	TUŠ VRATA TV/S 130/K LIJEVA

Sole **TV/S 100, 130 -D**

Salsa, Canary, Haka, Flamenco, Boston, Rock, Step zero, Lerock zero

Š.Vokel	Opis
<b>0405680</b>	TUŠ VRATA TV/S 100/K DESNA
	TUŠ VRATA TV/S 130/K DESNA

Sole **TP 75 -L -D**

Mogućnost montaže na sve kupaonske kade

Š.Vokel	Opis
<b>0405159</b>	TUŠ PARAVAN TP 75/K , BIJELO
<b>0405235</b>	TUŠ PARAVAN TP 75/K , SILVER

Sole **TP 77 -L**

Mogućnost montaže na sve kupaonske kade

Š.Vokel	Opis
<b>0405816</b>	TUŠ PARAVAN TP 77/K , BIJELO

Sole **TP 77 -D**

Mogućnost montaže na sve kupaonske kade

Š.Vokel	Opis
	TUŠ PARAVAN TP 77/K , BIJELO



Sole TP 112-L

Mogućnost montaže na sve kupaonske kade



Š.Vokel	Opis
0405378	TUŠ PARAVAN SOLE TP 112/K LIJEVA, BIJELO
0405307	TUŠ PARAVAN SOLE TP 112/CH LIJEVA, BIJELO
	TUŠ PARAVAN SOLE TP 112/SAT LIJEVA, BIJELO
0405290	TUŠ PARAVAN SOLE TP 112/K LIJEVA, S.BRILL
0405243	TUŠ PARAVAN SOLE TP 112/CH LIJEVA, S.BRILL
	TUŠ PARAVAN SOLE TP 112/SAT LIJEVA, S.BRILL



Sole TP 112-D

Mogućnost montaže na sve kupaonske kade



Š.Vokel	Opis
0405300	TUŠ PARAVAN SOLE TP 112/K DESNA, BIJELO
0405450	TUŠ PARAVAN SOLE TP 112/CH DESNA, BIJELO
	TUŠ PARAVAN SOLE TP 112/SAT DESNA, BIJELO
0405250	TUŠ PARAVAN SOLE TP 112/K DESNA, S.BRILL
0405477	TUŠ PARAVAN SOLE TP 112/CH DESNA, S.BRILL
	TUŠ PARAVAN SOLE TP 112/SAT DESNA, S.BRILL

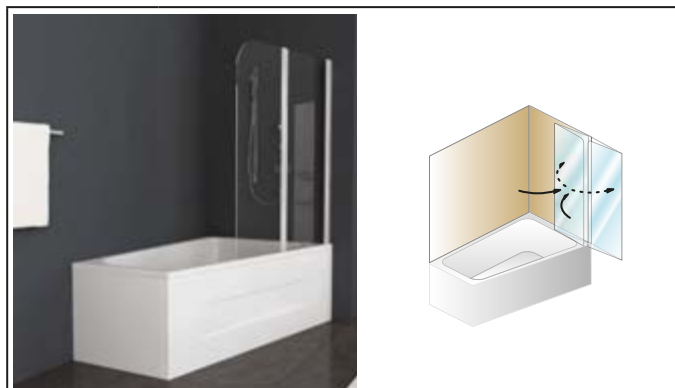

Sole TP 112 Beatrice -L

Beatrice-L



Š.Vokel	Opis
	TUŠ PARAVAN SOLE TP 112/K BEATRICE LIJEVA, SILVER BRILL



Sole TP 112 Beatrice -D

Beatrice-D



Š.Vokel	Opis
0405758	TUŠ PARAVAN SOLE TP 112/K BEATRICE DESNA, SILVER BRILL



Sole TP 102

Allegro, Royal, Dlvante -L



Š.Vokel	Opis
0405713	TUŠ PARAVAN SOLE TP 102/K LIJEVA, S.BRILL



Sole TP 102

Allegro, Royal, Dlvante -D



Š.Vokel	Opis
0405712	TUŠ PARAVAN SOLE TP 102/K DESNA, S.BRILL

Opcije:

Mogućnost narudžbe tuš vrata i paravana sa NANO SAN premazom.



Sole TP 102

☞ Chad-L



Sole TP 102

☞ Chad-D



Š.Vokel	Opis
	TUŠ PARAVAN SOLE TP 102/K CHAD LIJEVA, SILVER BRILL

Š.Vokel	Opis
	TUŠ PARAVAN SOLE TP 102/K CHAD DESNA, SILVER BRILL



Sole TP 104 -L

☞ Lulu, Calando



Sole TP 104 -D

☞ Lulu, Calando



Š.Vokel	Opis
<b>0405715</b>	TUŠ PARAVAN SOLE TP 104/K LIJEVA, S.BRILL

Š.Vokel	Opis
<b>0405714</b>	TUŠ PARAVAN SOLE TP 104/K DESNA, S.BRILL



Sole TP 123 -L

☞ Largo, Alba



Sole TP 123 -D

☞ Largo, Alba



Š.Vokel	Opis
<b>0405717</b>	TUŠ PARAVAN SOLE TP 123/K LIJEVA, S.BRILL

Š.Vokel	Opis
<b>0405716</b>	TUŠ PARAVAN SOLE TP 123/K DESNA, S.BRILL







Sole TP 143 **LOCO-L**

Loco-L



Š.Vokel	Opis
<b>0405259</b>	TUŠ PARAVAN SOLE TP 143/K LOCO LIJEVA, SILVER BRILL



Sole TP 143 **LOCO-D**

Loco-D



Š.Vokel	Opis
<b>0405669</b>	TUŠ PARAVAN SOLE TP 143/K LOCO DESNA, SILVER BRILL



Sole TP 90 -L

Fidelio



Š.Vokel	Opis
	TUŠ PARAVAN SOLE TP 90/K FIDELIO LIJEVA, SILVER BRILL



Sole TP 90 -D

Fidelio



Š.Vokel	Opis
	TUŠ PARAVAN SOLE TP 90/K FIDELIO DESNA, SILVER BRILL



Sole TP 80 **ARABELA-L**

Arabela-L



Š.Vokel	Opis
	TUŠ PARAVAN SOLE TP 80/K ARABELA LIJEVA, SILVER BRILL



Sole TP 80 **ARABELA-D**

Arabela-D



Š.Vokel	Opis
<b>0405776</b>	TUŠ PARAVAN SOLE TP 80/K ARABELA DESNA, SILVER BRILL

Opcije:

Mogućnost narudžbe tuš vrata i paravana sa NANO SAN premazom.



Mogućnost montaže na slijedeće tuš kade



Mogućnost montaže na navedene kupaonske kade

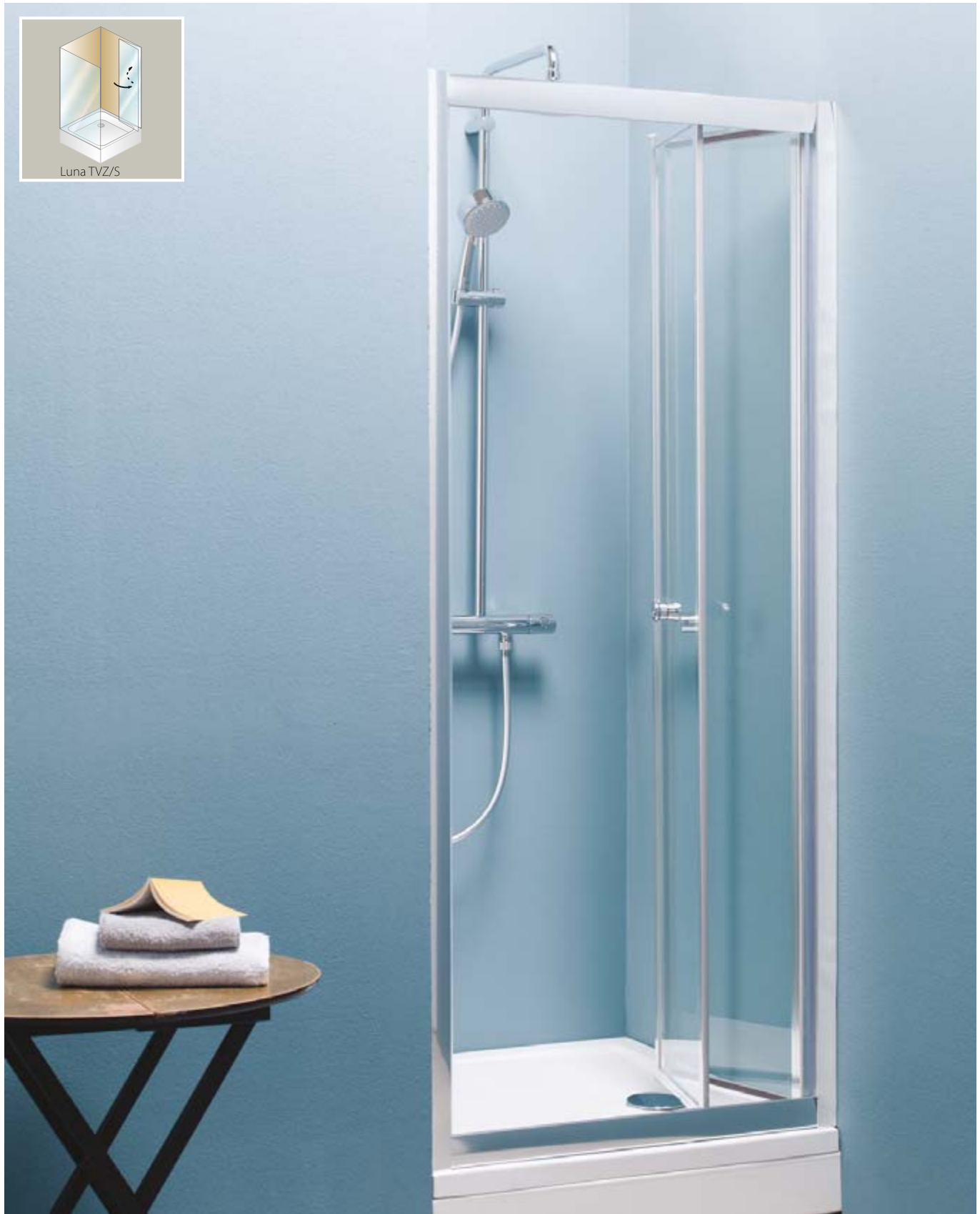

 **Luna**

4 mm prozirno kaljeno staklo



4 mm chinchilla kaljeno staklo



Srebrni profili (srebrna galvanska prevlaka)

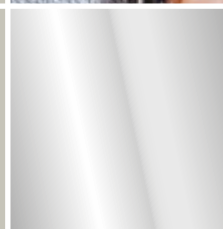

Zatvaranje s magnetskim profilom

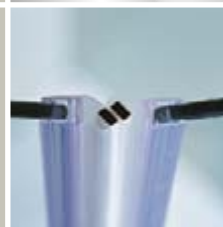

Mogućnost kompenzacijskog profila K-30



Luna										nanosan
Luna TVZ/S 80			78 - 80	185	57					
Luna TVZ/S 90			88 - 90	185	67					

Srebrna

Kaljeno prozirno staklo

Kaljeno chinchilla staklo



Luna TVZ/S 80

Canary, Haka, Salsa, Ska, Rock, Trin, Boston, Beat, Vip, Bono, Lerock zero, Flamenco, Horon, Vals



Š.Vokel	Opis
0405683	TUŠ VRATA LUNA TVZ/S 80/K SILVER
0405684	TUŠ VRATA LUNA TVZ/S 80/CH SILVER



Luna TVZ/S 90

Canary, Haka, Salsa, Ska, Rock, Trin, Boston, Beat, Vip, Bono, Lerock zero, Flamenco, Horon, Vals



Š.Vokel	Opis
0405685	TUŠ VRATA LUNA TVZ/S 90/K SILVER
0405686	TUŠ VRATA LUNA TVZ/S 90/CH SILVER



Varijanta s kompenzacijskim profilom K-30

K-30 Kompenzacijski profil za TVZ



Š.Vokel	Opis
0405687	K-30 TVZ KOMPENZACIJSKI PROFIL





 **Free line**



5/6 mm kaljeno prozirno staklo

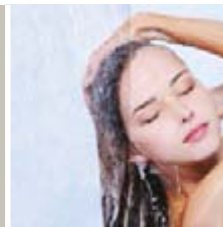

Srebrni profili (srebrna galvanska prevlaka)

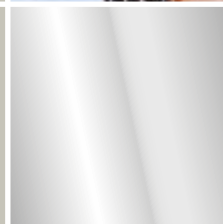

Zatvaranje s magnetskim profilom



Free line								nanosan
Free line <b>TKK 100</b>			98 - 99,5	190	58			
Free line <b>TV4D/S 120</b>			117,5 - 120	190	51			
Free line <b>TV4D/S 140</b>			117,5 - 140	190	59			
Free line <b>TV4D/S 160</b>			157,5 - 160	190	63			
Free line <b>TV4D/S 170</b>			168,5 - 170	190	73			
Free line <b>TS 70 NEW</b>			68 - 70	190				
Free line <b>TS 75 NEW</b>			73 - 75	190				
Free line <b>TS 80 NEW</b>			78 - 80	190				
Free line <b>TS 90 NEW</b>			88 - 90	190				



Free line **TKK 100**

Canary, Salsa, Rock, Boston, Step zero, Lerock zero, Vals

Š.Vokel	Opis
<b>0405746</b>	TUŠ KABINA FREE LINE TKK 100/K SILVER



Free line **TV4D/S 120, 140, 160, 170**

Canary, Haka, Salsa, Vip, Bono, Flamenco, Lerock zero, Vals

Š.Vokel	Opis
<b>0405743</b>	TUŠ VRATA FREE LINE TV4D/S 120/K SILVER
<b>0405744</b>	TUŠ VRATA FREE LINE TV4D/S 140/K SILVER
<b>0405745</b>	TUŠ VRATA FREE LINE TV4D/S 160/K SILVER
<b>0405756</b>	TUŠ VRATA FREE LINE TV4D/S 170/K SILVER



K-30 Dodatni profil za **TKK, TV4D** in **TS**

Š.Vokel	Opis
<b>0405591</b>	K-30 DODATNI PROFIL ZA TKK,TV4D i TS SILVER



Free line **TV4D/S 120, 140, 160, 170 + TS 70, 75, 80, 90 NEW**

Canary, Haka, Salsa, Vip, Bono, Flamenco, Lerock zero, Vals

Š.Vokel	Opis
<b>0405743</b>	TUŠ VRATA FREE LINE TV4D/S 120/K SILVER
<b>0405744</b>	TUŠ VRATA FREE LINE TV4D/S 140/K SILVER
<b>0405745</b>	TUŠ VRATA FREE LINE TV4D/S 160/K SILVER
<b>0405756</b>	TUŠ VRATA FREE LINE TV4D/S 170/K SILVER
<b>0405702</b>	TUŠ STJENKA FREE LINE TS70NEW/K SILVER
<b>0405718</b>	TUŠ STJENKA FREE LINE TS75NEW/K SILVER
<b>0405705</b>	TUŠ STJENKA FREE LINE TS80NEW/K SILVER
<b>0405706</b>	TUŠ STJENKA FREE LINE TS90NEW/K SILVER

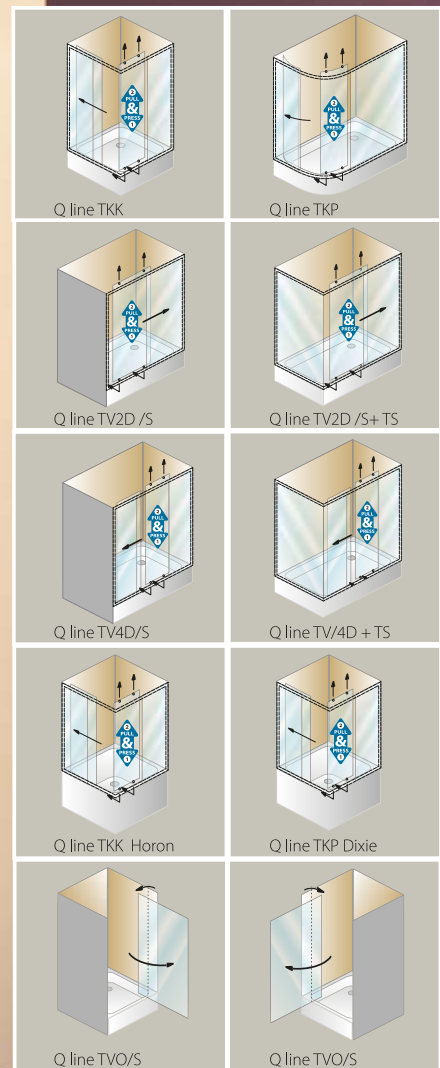

## Q line

Q	Q line										
	Q line TTK 70					68 - 69,5	190	37			
	Q line TTK 80					78 - 79,5	190	42			
	Q line TTK 90					88 - 89,5	190	54			
	Q line TTK 100					98 - 99,5	190	58			
	Q line TTK 70x90					68 - 69,5 x 88 - 89,5	190	42			
	Q line TTK 75x90					73 - 74,5 x 88 - 89,5	190	45			
	Q line TTK 80x90					78 - 79,5 x 88 - 89,5	190	48			
	Q line TTK 80x100					78 - 79,5 x 98 - 99,5	190	50			
	Q line TTK 90x100					88 - 89,5 x 98 - 99,5	190	56			
	Q line TTK 90 Horon					88 - 89,5	160	54			
	Q line TKP 80					78 - 79,5	190	42	55		
	Q line TKP 90					88 - 89,5	190	52	55		
	Q line TKP 100					98 - 99,5	190	52	55		
	Q line TKP 80x100					78 - 79,5 x 98 - 99,5	190	49	55		
	Q line TKP 90x120					88 - 89,5 x 118 - 119,5	190	53	55		

5/6 mm kaljeno prozirno staklo			
5/6 mm chinchilla kaljeno staklo			
Srebrni profili (srebrna galvanska prevlaka)			
Bijeli profil (plastificiranje)			
Zatvaranje s magnetskim profilom			
Mogućnost kompenzacijskih profila		Vratna krila na skidanje omogućuju lakše čišćenje	

Q	Q line									nanosan
	Q line <b>TKP 90 Dixie</b>					88 - 89,5	160	52		
	Q line <b>TV2D/S 100</b>					97,5 - 100	190	41		
	Q line <b>TV2D/S 110</b>					107,5 - 110	190	48		
	Q line <b>TV2D/S 120</b>					117,5 - 120	190	51		
	Q line <b>TV2D/S 130</b>					127,5 - 130	190	52		
	Q line <b>TV4D/S 140</b>					137,5 - 140	190	59		
	Q line <b>TV4D/S 160</b>					157,5 - 160	190	63		
	Q line <b>TV4D/S 170</b>					167,5 - 170	190	73		
	Q line <b>TS 70 NEW</b>					68 - 70	190			
	Q line <b>TS 75 NEW</b>					73 - 75	190			
	Q line <b>TS 80 NEW</b>					78 - 80	190			
	Q line <b>TS 90 NEW</b>					88 - 90	190			
	Q line <b>TVO/S 80</b>					78 - 80	190	53		
	Q line <b>TVO/S 90</b>					88 - 90	190	63		



Q line **TKK** 70x70, 70x90, 75x90, 80, 80x90, 80x100, 90, 90x100, 100

Lerock, Step zero, Canary, Haka, Ska, Flamenco, Beat, Rock, Boston, Horon, Trin, Salsa, Vals



Q line **TKP** 80, 90, 100

Eisa, Macarena, Blues, Pony, Bossanova, Bebop, Dixie, Ontex

Š.Vokel	Opis
	TUŠ KABINA Q LINE TTK 70x70/K BIJELO
<b>0405602</b>	TUŠ KABINA Q LINE TTK 70x90/K BIJELO
	TUŠ KABINA Q LINE TTK 75x90/K BIJELO
<b>0405603</b>	TUŠ KABINA Q LINE TTK 80x80/K BIJELO
<b>0405605</b>	TUŠ KABINA Q LINE TTK 80x90/K BIJELO
<b>0405607</b>	TUŠ KABINA Q LINE TTK 80x100/K BIJELO
<b>0405609</b>	TUŠ KABINA Q LINE TTK 90x90/K BIJELO
<b>0405611</b>	TUŠ KABINA Q LINE TTK 90x100/K BIJELO
<b>0405613</b>	TUŠ KABINA Q LINE TTK 100x100/K BIJELO
	TUŠ KABINA Q LINE TTK 70x70/CH BIJELO
<b>0405572</b>	TUŠ KABINA Q LINE TTK 70x90/CH BIJELO
<b>0405770</b>	TUŠ KABINA Q LINE TTK 75x90/CH BIJELO
<b>0405604</b>	TUŠ KABINA Q LINE TTK 80x80/CH BIJELO
<b>0405606</b>	TUŠ KABINA Q LINE TTK 80x90/CH BIJELO
<b>0405608</b>	TUŠ KABINA Q LINE TTK 80x100/CH BIJELO
<b>0405610</b>	TUŠ KABINA Q LINE TTK 90x90/CH BIJELO
<b>0405612</b>	TUŠ KABINA Q LINE TTK 90x100/CH BIJELO
<b>0405614</b>	TUŠ KABINA Q LINE TTK 100x100/CH BIJELO
<b>0405771</b>	TUŠ KABINA Q LINE TTK 70x70/K SILVER
<b>0405648</b>	TUŠ KABINA Q LINE TTK 70x90/K SILVER
<b>0405781</b>	TUŠ KABINA Q LINE TTK 75x90/K SILVER
<b>0405658</b>	TUŠ KABINA Q LINE TTK 80x80/K SILVER
<b>0405571</b>	TUŠ KABINA Q LINE TTK 80x90/K SILVER
<b>0405655</b>	TUŠ KABINA Q LINE TTK 80x100/K SILVER
<b>0405653</b>	TUŠ KABINA Q LINE TTK 90x90/K SILVER
<b>0405651</b>	TUŠ KABINA Q LINE TTK 90x100/K SILVER
<b>0405649</b>	TUŠ KABINA Q LINE TTK 100x100/K SILVER
<b>0405772</b>	TUŠ KABINA Q LINE TTK 70x70/CH SILVER
<b>0405659</b>	TUŠ KABINA Q LINE TTK 70x90/CH SILVER
<b>0405752</b>	TUŠ KABINA Q LINE TTK 75x90/CH SILVER
<b>0405657</b>	TUŠ KABINA Q LINE TTK 80x80/CH SILVER
<b>0405656</b>	TUŠ KABINA Q LINE TTK 80x90/CH SILVER
<b>0405654</b>	TUŠ KABINA Q LINE TTK 80x100/CH SILVER
<b>0405652</b>	TUŠ KABINA Q LINE TTK 90x90/CH SILVER
<b>0405650</b>	TUŠ KABINA Q LINE TTK 90x100/CH SILVER
<b>0405600</b>	TUŠ KABINA Q LINE TTK 100x100/CH SILVER

Š.Vokel	Opis
<b>0405574</b>	TUŠ KABINA Q LINE TKP 80x80/K BIJELO
<b>0405567</b>	TUŠ KABINA Q LINE TKP 90x90/K BIJELO
<b>0405617</b>	TUŠ KABINA Q LINE TKP 100x100/K BIJELO
<b>0405575</b>	TUŠ KABINA Q LINE TKP 80x80/CH BIJELO
<b>0405568</b>	TUŠ KABINA Q LINE TKP 90x90/CH BIJELO
<b>0405596</b>	TUŠ KABINA Q LINE TKP 100x100/CH BIJELO
<b>0405573</b>	TUŠ KABINA Q LINE TKP 80x80/K SILVER
<b>0405565</b>	TUŠ KABINA Q LINE TKP 90x90/K SILVER
<b>0405646</b>	TUŠ KABINA Q LINE TKP 100x100/K SILVER
<b>0405642</b>	TUŠ KABINA Q LINE TKP 80x80/CH SILVER
<b>0405566</b>	TUŠ KABINA Q LINE TKP 90x90/CH SILVER
<b>0405647</b>	TUŠ KABINA Q LINE TKP 100x100/CH SILVER





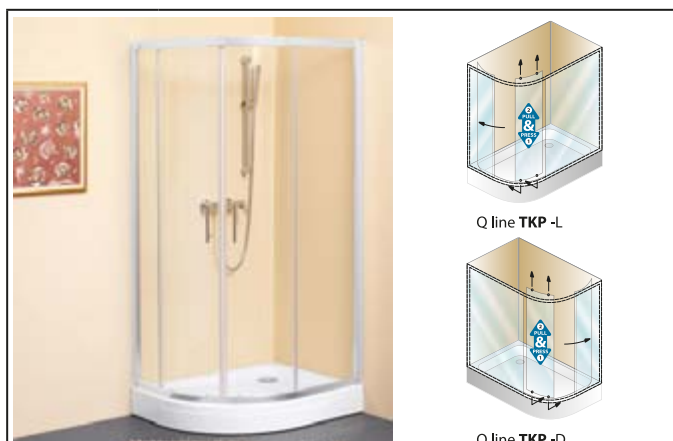

Q line **TKP** 80x100, 90x120

Malur -L, Malur -D



Š.Vokel	Opis
0405597	TUŠ KABINA Q LINE TKP 80x100/K BIJELO
0405616	TUŠ KABINA Q LINE TKP 90x120/K BIJELO
0405615	TUŠ KABINA Q LINE TKP 80x100/CH BIJELO
0405582	TUŠ KABINA Q LINE TKP 90x120/CH BIJELO
0405643	TUŠ KABINA Q LINE TKP 80x100/K SILVER
0405583	TUŠ KABINA Q LINE TKP 90x120/K SILVER
0405644	TUŠ KABINA Q LINE TKP 80x100/CH SILVER
0405645	TUŠ KABINA Q LINE TKP 90x120/CH SILVER



Q line **TV2D/S** 100, 110, 120, 130

Vip, Canary, Haka, Boston, Rock, Flamenco, Step zero, Whip, Lerock zero, Salsa, Vals



Š.Vokel	Opis
0405720	TUŠ VRATA Q LINE TV2D/S 100/K BIJELO
0405722	TUŠ VRATA Q LINE TV2D/S 110/K BIJELO
0405724	TUŠ VRATA Q LINE TV2D/S 120/K BIJELO
0405726	TUŠ VRATA Q LINE TV2D/S 130/K BIJELO
0405721	TUŠ VRATA Q LINE TV2D/S 100/CH BIJELO
0405723	TUŠ VRATA Q LINE TV2D/S 110/CH BIJELO
0405725	TUŠ VRATA Q LINE TV2D/S 120/CH BIJELO
0405727	TUŠ VRATA Q LINE TV2D/S 130/CH BIJELO
0405688	TUŠ VRATA Q LINE TV2D/S 100/K SILVER
0405690	TUŠ VRATA Q LINE TV2D/S 110/K SILVER
0405692	TUŠ VRATA Q LINE TV2D/S 120/K SILVER
0405694	TUŠ VRATA Q LINE TV2D/S 130/K SILVER
0405689	TUŠ VRATA Q LINE TV2D/S 100/CH SILVER
0405691	TUŠ VRATA Q LINE TV2D/S 110/CH SILVER
0405693	TUŠ VRATA Q LINE TV2D/S 120/CH SILVER
0405695	TUŠ VRATA Q LINE TV2D/S 130/CH SILVER



Q line **TV4D/S** 140, 160, 170

Bono, Flamenco, Salsa, Canary



Š.Vokel	Opis
0405728	TUŠ VRATA Q LINE TV4D/S 140/K BIJELO
0405730	TUŠ VRATA Q LINE TV4D/S 160/K BIJELO
0405732	TUŠ VRATA Q LINE TV4D/S 170/K BIJELO
0405729	TUŠ VRATA Q LINE TV4D/S 140/CH BIJELO
0405731	TUŠ VRATA Q LINE TV4D/S 160/CH BIJELO
0405733	TUŠ VRATA Q LINE TV4D/S 170/CH BIJELO
0405696	TUŠ VRATA Q LINE TV4D/S 140/K SILVER
0405698	TUŠ VRATA Q LINE TV4D/S 160/K SILVER
0405701	TUŠ VRATA Q LINE TV4D/S 170/K SILVER
0405697	TUŠ VRATA Q LINE TV4D/S 140/CH SILVER
0405699	TUŠ VRATA Q LINE TV4D/S 160/CH SILVER
0405700	TUŠ VRATA Q LINE TV4D/S 170/CH SILVER

Opcije:





Q line **TV2D/S** 100, 110, 120, 130, + **TS** 70, 75, 80, 90 **NEW**

Vip, Canary, Haka, Rock, Flamenco, Lerock zero, Salsa, Vals



Q line **TV4D/S** 140, 160, 170 + **TS** 70, 75, 80, 90 **NEW**

Bono, Flamenco, Salsa, Canary



Š.Vokel	Opis
0405597	TUŠ KABINA Q LINE TKP 80x100/K BIJELO
0405616	TUŠ KABINA Q LINE TKP 90x120/K BIJELO
0405615	TUŠ KABINA Q LINE TKP 80x100/CH BIJELO
0405582	TUŠ KABINA Q LINE TKP 90x120/CH BIJELO
0405643	TUŠ KABINA Q LINE TKP 80x100/K SILVER
0405583	TUŠ KABINA Q LINE TKP 90x120/K SILVER
0405644	TUŠ KABINA Q LINE TKP 80x100/CH SILVER
0405645	TUŠ KABINA Q LINE TKP 90x120/CH SILVER

Š.Vokel	Opis
0405720	TUŠ VRATA Q LINE TV2D/S 100/K BIJELO
0405722	TUŠ VRATA Q LINE TV2D/S 110/K BIJELO
0405724	TUŠ VRATA Q LINE TV2D/S 120/K BIJELO
0405726	TUŠ VRATA Q LINE TV2D/S 130/K BIJELO
0405721	TUŠ VRATA Q LINE TV2D/S 100/CH BIJELO
0405723	TUŠ VRATA Q LINE TV2D/S 110/CH BIJELO
0405725	TUŠ VRATA Q LINE TV2D/S 120/CH BIJELO
0405727	TUŠ VRATA Q LINE TV2D/S 130/CH BIJELO
0405688	TUŠ VRATA Q LINE TV2D/S 100/K SILVER
0405690	TUŠ VRATA Q LINE TV2D/S 110/K SILVER
0405692	TUŠ VRATA Q LINE TV2D/S 120/K SILVER
0405694	TUŠ VRATA Q LINE TV2D/S 130/K SILVER
0405689	TUŠ VRATA Q LINE TV2D/S 100/CH SILVER
0405691	TUŠ VRATA Q LINE TV2D/S 110/CH SILVER
0405693	TUŠ VRATA Q LINE TV2D/S 120/CH SILVER
0405695	TUŠ VRATA Q LINE TV2D/S 130/CH SILVER

Š.Vokel	Opis
0405734	TUŠ STJENKA Q LINE TS 70/K NEW BIJELO
0405736	TUŠ STJENKA Q LINE TS 75/K NEW BIJELO
0405738	TUŠ STJENKA Q LINE TS 80/K NEW BIJELO
0405740	TUŠ STJENKA Q LINE TS 90/K NEW BIJELO
0405735	TUŠ STJENKA Q LINE TS 70/CH NEW BIJELO
0405737	TUŠ STJENKA Q LINE TS 75/CH NEW BIJELO
0405739	TUŠ STJENKA Q LINE TS 80/CH NEW BIJELO
0405741	TUŠ STJENKA Q LINE TS 90/CH NEW BIJELO
0405702	TUŠ STJENKA Q LINE TS 70/K NEW SILVER
0405718	TUŠ STJENKA Q LINE TS 75/K NEW SILVER
0405705	TUŠ STJENKA Q LINE TS 80/K NEW SILVER
0405706	TUŠ STJENKA Q LINE TS 90/K NEW SILVER
0405703	TUŠ STJENKA Q LINE TS 70/CH NEW SILVER
0405719	TUŠ STJENKA Q LINE TS 75/CH NEW SILVER
0405704	TUŠ STJENKA Q LINE TS 80/CH NEW SILVER
0405707	TUŠ STJENKA Q LINE TS 90/CH NEW SILVER





Q line **TKP** 90 DIXIE

Dixie



Q line **TKK** 90 HORON

Horon

Š.Vokel	Opis
<b>0405568</b>	TUŠ KABINA Q LINE TKP 90x90/CH BIJELO
<b>0405566</b>	TUŠ KABINA Q LINE TKP 90x90/CH SILVER

Š.Vokel	Opis
<b>0405610</b>	TUŠ KABINA Q LINE TTK 90x90/CH BIJELO
<b>0405652</b>	TUŠ KABINA Q LINE TTK 90x90/CH SILVER



Q line **TVO/S** 80, 90

Canary, Haka, Salsa, Ska, Rock, Trin, Boston, Beat, Vip, Bono, Step zero, Flamenco, Lerock zero, Horon, Vals

Š.Vokel	Opis
<b>0405708</b>	TUŠ VRATA Q LINE TVO/S 80/K SILVER
<b>0405709</b>	TUŠ VRATA Q LINE TVO/S 80/CH SILVER
<b>0405711</b>	TUŠ VRATA Q LINE TVO/S 90/K SILVER
<b>0405710</b>	TUŠ VRATA Q LINE TVO/S 90/CH SILVER



**K-25** Kompenzacijski profil za **TVO/S**



**K-30** Kompenzacijski profil za **TKK, TKP, TV2D, TV4D** in **TS Q line**

Š.Vokel	Opis
<b>0405591</b>	<b>K-30</b> KOMPENZACIJSKI PROFIL ZA <b>TKK, TKP</b> i <b>TV Q LINE</b>

Opcije:



Mogućnost montaže na sljedeće tuš kade

\* Dodatni profil za podešavanje izvan standardnih dimenzija kabina po širini



**Q Quat**

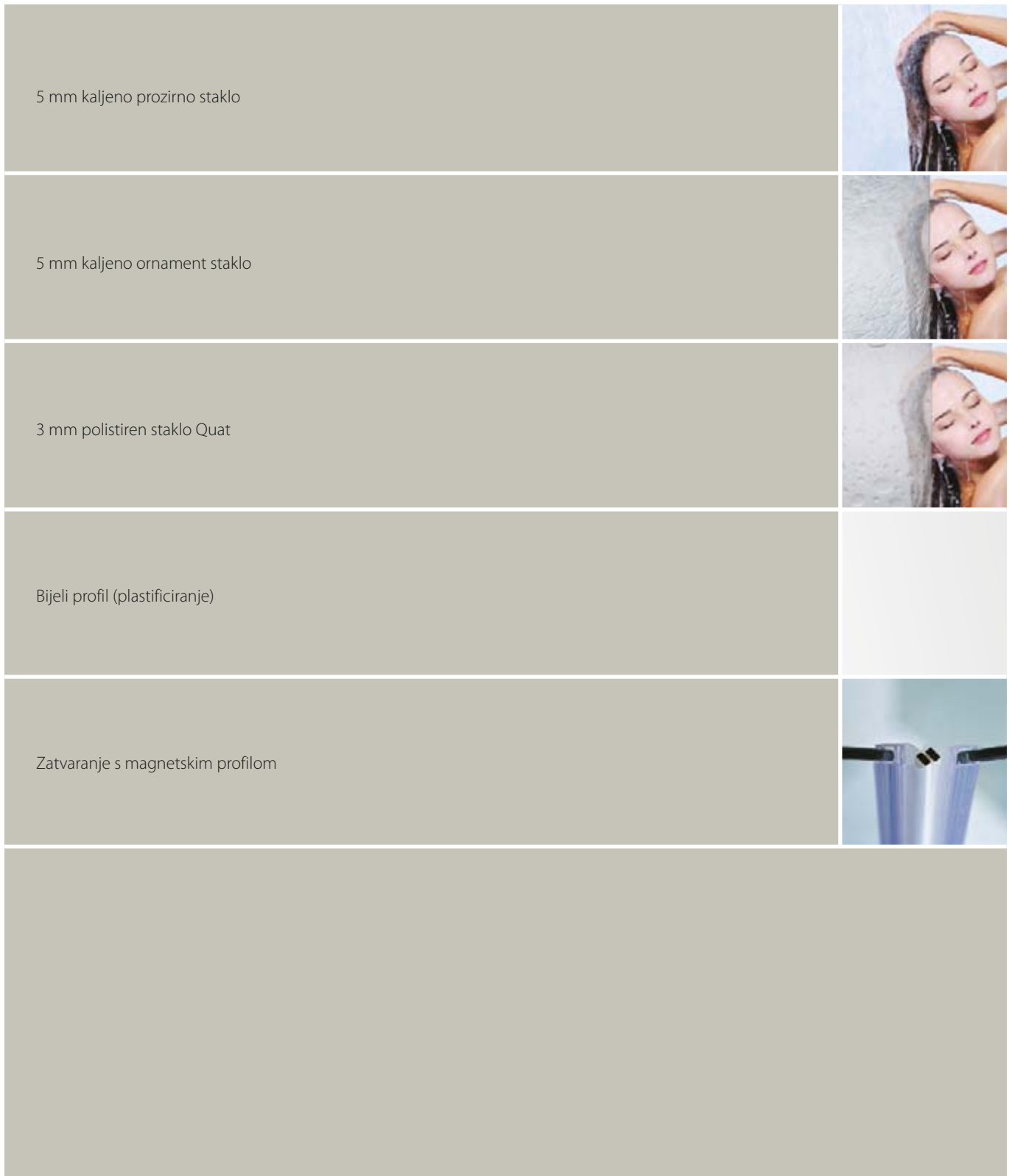

Q	Quat										nanosan
	Quat <b>TKK 80</b>			78 - 79,5	185	45					
	Quat <b>TKK 90</b>			88 - 89,5	185	54					
	Quat <b>TKP 80</b>			78 - 79,5	185	42		55			
	Quat <b>TKP 90</b>			88 - 89,5	185	52		55			
	Quat <b>TP 75 - L, - D</b>				140		75				
	Quat <b>TP 110</b>				140		110				
	Quat <b>TP 140</b>				140		135				
	Quat <b>TP 105</b>				140		105				
	Quat <b>TP 108</b>				140		108				



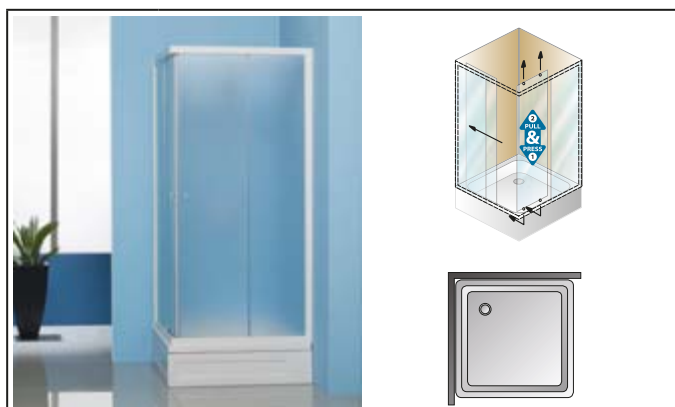

Quat TTK 80, 90

Canary, Haka, Salsa, Rock, Boston, Beat, Flamenco, Horon, Trin, Vals

Š.Vokel	Opis
0405549	TUŠ KABINA QUAT TTK 80x80/K BIJELO
0405548	TUŠ KABINA QUAT TTK 90x90/K BIJELO
0405370	TUŠ KABINA QUAT TTK 90x90/KO BIJELO

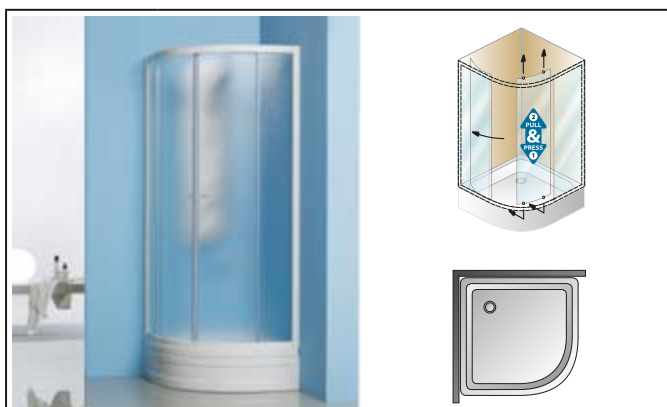

Quat TKP 80, 90

Macarena, Bebop, Eisa, Blues, Dixie, Bossanova, Pony, Ontex

Š.Vokel	Opis
0405550	TUŠ KABINA QUAT TKP 80x80/K BIJELO
0405371	TUŠ KABINA QUAT TKP 80x80/KO BIJELO
0405551	TUŠ KABINA QUAT TKP 90x90/K BIJELO
0405372	TUŠ KABINA QUAT TKP 90x90/KO BIJELO



Quat TP 75-L

Mogućnost montaže na sve kupaonske kade

Š.Vokel	Opis
0405476	TUŠ PARAVAN QUAT TP 75/K LIJEVO BIJELO



Quat TP 75-D

Mogućnost montaže na sve kupaonske kade

Š.Vokel	Opis
0405502	TUŠ PARAVAN QUAT TP 75/K DESNO BIJELO



Quat TP 110

Mogućnost montaže na sve kupaonske kade

Š.Vokel	Opis
06793	TUŠ PARAVAN DVODJELNI QUAT TP 110/ POLISTIRENSKO STAKLO - BIJELO PROFIL

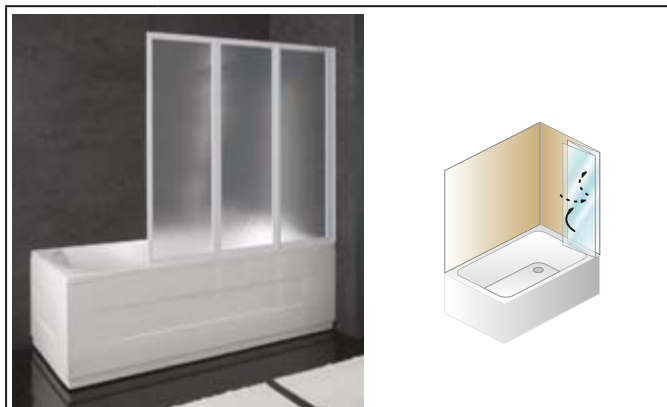

Quat TP 140

Mogućnost montaže na sve kupaonske kade

Š.Vokel	Opis
06097	TUŠ PARAVAN TRODJELNI QUAT TP 140/ POLISTIRENSKO STAKLO - BIJELO PROFIL



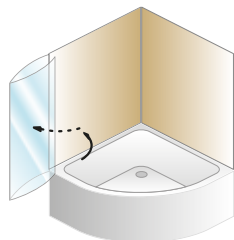

Quat TP 105

Alba, Largo, Allegro, Royal, Romeo, Divante

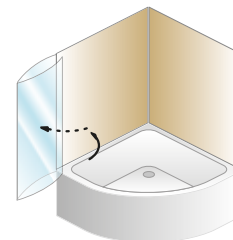

Quat TP 108

Lulu, Voice

Š.Vokel	Opis
0405207	TUŠ PARAVAN DVODJELNI QUAT TP 105/ POLISTIRENSKO STAKLO - BIJELI PROFIL

Š.Vokel	Opis
0405404	TUŠ PARAVAN DVODJELNI QUAT TP 108/ POLISTIRENSKO STAKLO - BIJELI PROFIL



Opcije:



Mogućnost montaže na slijedeće tuš kade



Mogućnost montaže na navedene kupaonske kade



## Koje značajke odlikuju kupaonički namještaj Kolpa san?

### Za program kupaoničkog namještaja Kolpa san vrijede sljedeće značajke:

- sav namještaj iz programa Kolpa san odgovara europskim standardima sigurnosti, kvalitete i trajnosti.
- upotreba ljepila i rubnih traka otpornih na vlagu
- isključiva upotreba materijala europskih proizvođača s odgovarajućim certifikatima EU
- upotreba kvalitetnih okova za tiho zatvaranje

## Legenda

**LED:** LED svjetlo

**NEON:** Neonsko svjetlo

**HAL:** Halogeno svjetlo

**E14:** Obično svjetlo

**T:** Svjetlo s senzorskim prekidačem ili na dodir

**SW:** Svjetlo s prekidačem

**S:** Utičnica

**C:** Sat



svjetlo



A++

A+

A

C

energetski razred



tiho zatvaranje ladice



tiho zatvaranje vrata



push zatvaranje ladice



push zatvaranje vrata

# Kupaonski namještaj





## nayra 120, 100

**Fronte:** obložen MDF PVC folijom  
- bijela mat (WH), svijetli ariš (LAR), wenge

**Obod:** oplemenjena iverica  
- bijela (WH), svijetli ariš (LAR), wenge

**Umivaonik:** lijevani mramor

**Ručice:** mat

**Svijetlo:**  
OGN 90, 110 -LED, T : 12,3W/14 W  
TON 90, 110 -LED, SW, S: 12W/14 W



white

NAMJEŠTAJ NAYRA 120 BIJELO (WH)	
Š.Vokel	Opis
0406672	OGLEDALO SA LED SVJETILJKOM I SENZORSKIM PREKIDAČEM OGN 110 - LED, T
0406668	TOALETNI ORMARIĆ SA LED SVJETILJKOM, PREKIDAČEM I UTIČNICOM TON 110 - LED, SW, T BIJELO
0406669	ORMAR S UMIVAONIKOM OUN 120 BIJELO
0406670	ORMARIĆ S VRATIMA I LADICOM H = 870 N 871 BIJELO
0406639	ORMARIĆ S VRATIMA I LADICAMA H = 1700 N 1701 BIJELO
0406571	NOGICE ZA ORMARIĆE H = 20 cm (Par)

NAMJEŠTAJ NAYRA 100 BIJELO (WH)	
Š.Vokel	Opis
0406652	OGLEDALO SA LED SVJETILJKOM I SENZORSKIM PREKIDAČEM OGN 90 - LED, T
0406638	TOALETNI ORMARIĆ SA LED SVJETILJKOM, PREKIDAČEM I UTIČNICOM TON 90 - LED, SW, T BIJELO
0406637	ORMAR S UMIVAONIKOM OUN 100 BIJELO
0406670	ORMARIĆ S VRATIMA I LADICOM H = 870 N 871 BIJELO
0406639	ORMARIĆ S VRATIMA I LADICAMA H = 1700 N 1701 BIJELO
0406571	NOGICE ZA ORMARIĆE H = 20 cm (Par)

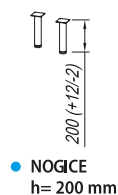
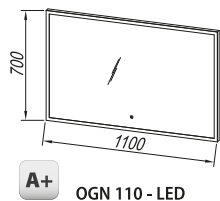
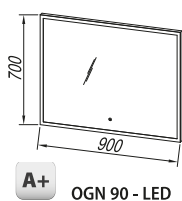
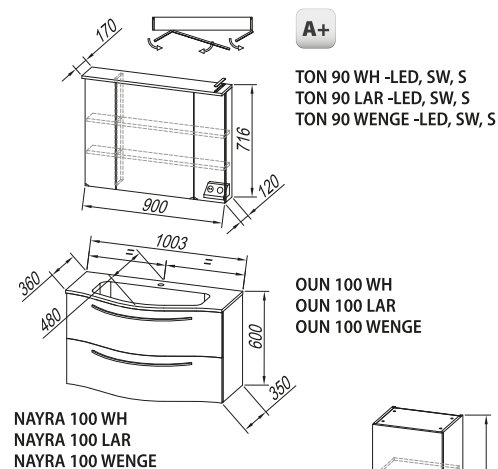
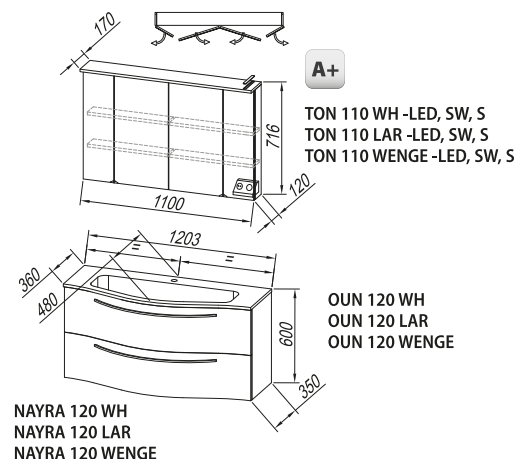

N 871 WH  
N 871 LAR  
N 871 WENGE

N 1701 WH  
N 1701 LAR  
N 1701 WENGE





## nayra 120, 100

**Fronte:** obložen MDF PVC folijom  
- bijela mat (WH), svijetli ariš (LAR), wenge

**Obod:** oplemenjena iverica  
- bijela (WH), svijetli ariš (LAR), wenge

**Umivaonik:** lijevani mramor

**Ručice:** mat

**Svijetlo:**  
OGN 90, 110 -LED, T : 12,3W/14 W  
TON 90, 110 -LED, SW, S: 12W/14 W



wenge

### NAMJEŠTAJ NAYRA 120 WENGE (WENGE)

Š.Vokel	Opis
0406672	OGLEDALO SA LED SVJETILJKOM I SENZORSKIM PREKIDAČEM OGN 110 - LED, T
	TOALETNI ORMARIĆ SA LED SVJETILJKOM, PREKIDAČEM I UTIČNICOM TON 110 - LED, SW, T WENGE
0406673	ORMAR S UMIVAONIKOM OUN 120 WENGE
	ORMARIĆ S VRATIMA I LADICOM H = 870 N 871 WENGE
0406651	ORMARIĆ S VRATIMA I LADICAMA H = 1700 N 1701 WENGE
0406571	NOGICE ZA ORMARIĆE H = 20 cm (Par)

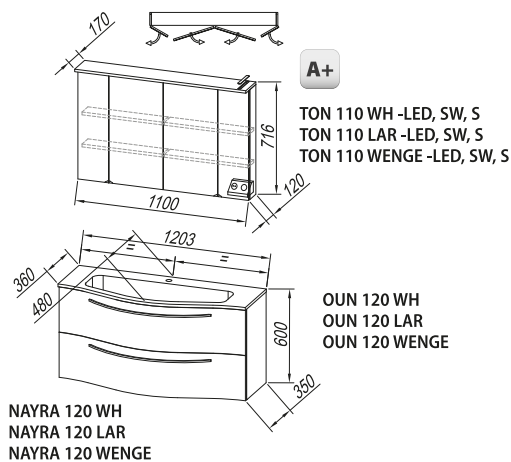

### NAMJEŠTAJ NAYRA 100 WENGE (WENGE)

Š.Vokel	Opis
	OGLEDALO SA LED SVJETILJKOM I SENZORSKIM PREKIDAČEM OGN 90 - LED, T
0406649	TOALETNI ORMARIĆ SA LED SVJETILJKOM, PREKIDAČEM I UTIČNICOM TON 90 - LED, SW, T WENGE
0406650	ORMAR S UMIVAONIKOM OUN 100 WENGE
	ORMARIĆ S VRATIMA I LADICOM H = 870 N 871 WENGE
0406651	ORMARIĆ S VRATIMA I LADICAMA H = 1700 N 1701 WENGE
0406571	NOGICE ZA ORMARIĆE H = 20 cm (Par)

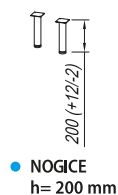
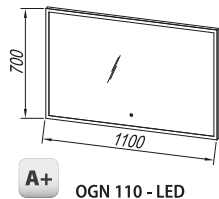
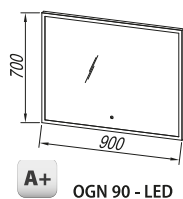
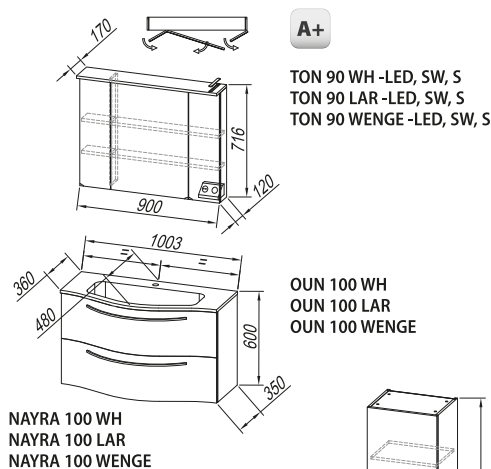

N 871 WH  
N 871 LAR  
N 871 WENGE

N 1701 WH  
N 1701 LAR  
N 1701 WENGE



## nayra 120, 100

**Fronte:** obložen MDF PVC folijom  
- bijela mat (WH), svijetli ariš (LAR), wenge

**Obod:** oplemenjena iverica  
- bijela (WH), svijetli ariš (LAR), wenge

**Umivaonik:** lijevani mramor

**Ručice:** mat

**Svijetlo:**  
OGN 90, 110 -LED, T : 12,3W/14 W  
TON 90, 110 -LED, SW, S: 12W/14 W



lar

NAMJEŠTAJ NAYRA 120 SVIJETLI ARIŠ (LAR)	
Š.Vokel	Opis
	OGLEDALO SA LED SVJETILJKOM I SENZORSKIM PREKIDAČEM OGN 110 - LED, T
	TOALETNI ORMARIĆ SA LED SVJETILJKOM, PREKIDAČEM I UTIČNICOM TON 110 - LED, SW, T SVIJETLI ARIŠ
	ORMAR S UMIVAONIKOM OUN 120 SVIJETLI ARIŠ
	ORMARIĆ S VRATIMA I LADICOM H = 870 N 871 SVIJETLI ARIŠ
	ORMARIĆ S VRATIMA I LADICAMA H = 1700 N 1701 SVIJETLI ARIŠ
	NOGICE ZA ORMARIĆE H = 20 cm (Par)

NAMJEŠTAJ NAYRA 100 SVIJETLI ARIŠ (LAR)	
Š.Vokel	Opis
	OGLEDALO SA LED SVJETILJKOM I SENZORSKIM PREKIDAČEM OGN 90 - LED, T
	TOALETNI ORMARIĆ SA LED SVJETILJKOM, PREKIDAČEM I UTIČNICOM TON 90 - LED, SW, T SVIJETLI ARIŠ
	ORMAR S UMIVAONIKOM OUN 100 SVIJETLI ARIŠ
	ORMARIĆ S VRATIMA I LADICOM H = 870 N 871 SVIJETLI ARIŠ
	ORMARIĆ S VRATIMA I LADICAMA H = 1700 N 1701 SVIJETLI ARIŠ
	NOGICE ZA ORMARIĆE H = 20 cm (Par)

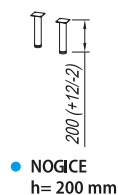
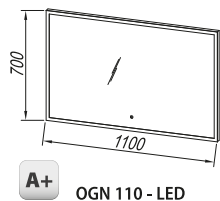
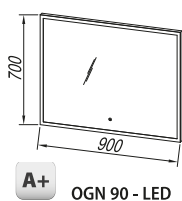
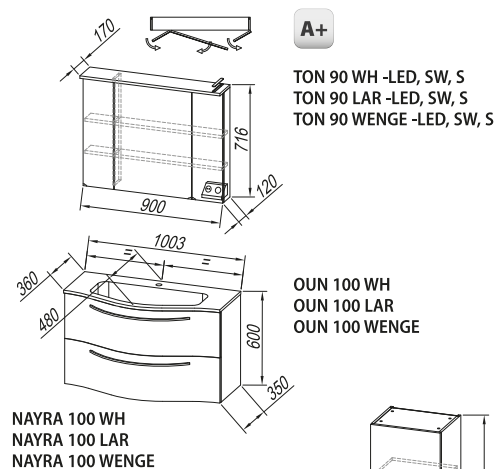
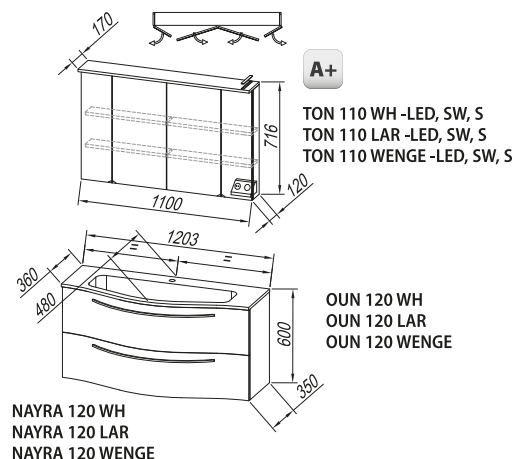

N 871 WH  
N 871 LAR  
N 871 WENGE

N 1701 WH  
N 1701 LAR  
N 1701 WENGE

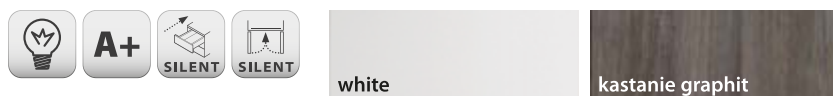

## elisa 140, 110 -L,D, 80

### Fronte:

obložen MDF PVC folijom / bijela (visoki sjaj),  
kastanie graphit

**Obod:** oplemenjena iverica/ bijela, sjaj

**Umivaonik:** lijevani mramor

**Ručice:** mat

**Svijetlo:** LED 4,5 W

NAMJEŠTAJ ELISA 140 BIJELO (WH)	
Š.Vokel	Opis
0406610	TOALETNI ORMARIĆ SA LED SVJETILJKOM TOE 140 - LED
0406611	ORMAR S UMIVAONIKOM OUE 140 WH BIJELO
0406605	ORMARIĆ S VRATIMA I LADICOM H = 744 E 741 WH BIJELO
0406613	ORMARIĆ S VRATIMA I LADICOM H = 1600 E 1601 WH BIJELO
0406606	ORMARIĆ S VRATIMA I LADICOM H = 1600/600 E 1601/600 WH BIJELO
0406609	NOGICE ZA ORMARIĆE H = 40 cm (Par)

NAMJEŠTAJ ELISA 140 KASTANIE GRAPHIT (KAST.GRAPH.)	
Š.Vokel	Opis
0406610	TOALETNI ORMARIĆ SA LED SVJETILJKOM TOE 140 - LED
0406614	ORMAR S UMIVAONIKOM OUE 140 KAST.GRAPHIT
0406656	ORMARIĆ S VRATIMA I LADICOM H = 744 E 741 KAST.GRAPHIT
0406615	ORMARIĆ S VRATIMA I LADICOM H = 1600 E 1601 KAST.GRAPHIT
	ORMARIĆ S VRATIMA I LADICOM H = 1600/600 E 1601/600 KAST.GRAPHIT
0406609	NOGICE ZA ORMARIĆE H = 40 cm (Par)

A+

TOE 140 WH -LED

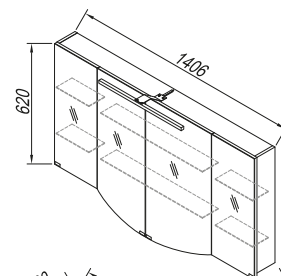

OUE 140 WH  
OUE 140 KAST. GRAPH.

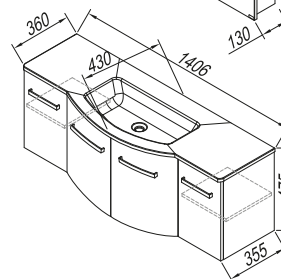

Elisa 140 WH  
Elisa 140 KAST. GRAPH.

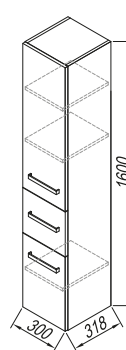

E 1601 WH  
E 1601 KAST. GRAPH.

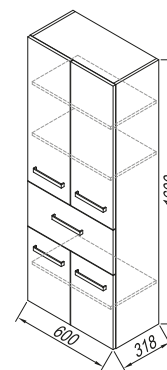

E 1601/600 WH  
E 1601/600 KAST. GRAPH.



• NOGICE  
h= 400 mm

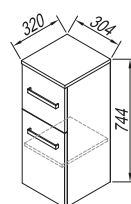

E 741 WH  
E 741 KAST. GRAPH.



NAMJEŠTAJ ELISA 110 KASTANIE GRAPHIT (KAST.GRAPH.) - DESNI	
Š.Vokel	Opis
0406602	TOALETNI ORMARIĆ SA LED SVJETILJKOM TOE 110 CAST.GRAPH.-D DESNI
	ORMAR S UMIVAONIKOM OUE 110-D CAST.GRAPH. DESNI
0406656	ORMARIĆ S VRATIMA I LADICOM H = 744 E 741 KAST.GRAPHIT
	ORMARIĆ S VRATIMA I LADICOM H = 1600 E 1601 KAST.GRAPHIT
0406615	ORMARIĆ S VRATIMA I LADICOM H = 1600/600 E 1601/600 KAST.GRAPHIT
0406609	NOGICE ZA ORMARIĆE H = 40 cm (Par)

NAMJEŠTAJ ELISA 110 BIJELO (WH) - DESNI	
Š.Vokel	Opis
0406602	TOALETNI ORMARIĆ SA LED SVJETILJKOM TOE 110 WH-D BIJELO DESNI
0406604	ORMAR S UMIVAONIKOM OUE 110 WH-D BIJELO DESNI
0406605	ORMARIĆ S VRATIMA I LADICOM H = 744 E 741 WH BIJELO
0406613	ORMARIĆ S VRATIMA I LADICOM H = 1600 E 1601 WH BIJELO
0406606	ORMARIĆ S VRATIMA I LADICOM H = 1600/600 E 1601/600 WH BIJELO
0406609	NOGICE ZA ORMARIĆE H = 40 cm (Par)

### elisa 110-D

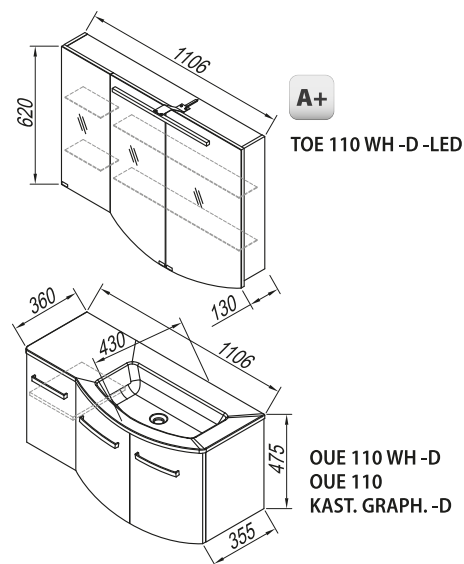

Elisa 110 WH-D  
Elisa 110 KAST. GRAPH. -D

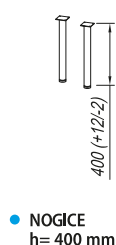

• NOGICE  
h= 400 mm

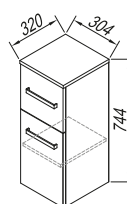

E 741 WH  
E 741 KAST. GRAPH.

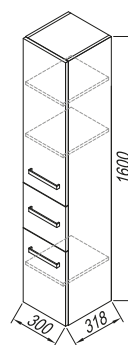

E 1601 WH  
E 1601 KAST. GRAPH.

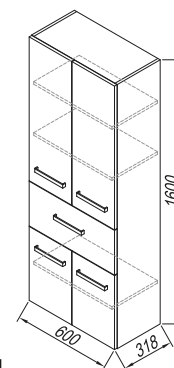

E 1601/600 WH  
E 1601/600 KAST. GRAPH.





### NAMJEŠTAJ ELISA 110 KASTANIE GRAPHIT (KAST.GRAPH.) - LIJEVI

Š.Vokel	Opis
	TOALETNI ORMARIĆ SA LED SVJETILJKOM TOE 110 CAST.GRAPH.-L LIJEVI
	ORMAR S UMIVAONIKOM OUE 110-L CAST.GRAPH. LIJEVI
0406656	ORMARIĆ S VRATIMA I LADICOM H = 744 E 741 KAST.GRAPHIT
	ORMARIĆ S VRATIMA I LADICOM H = 1600 E 1601 KAST.GRAPHIT
0406615	ORMARIĆ S VRATIMA I LADICOM H = 1600/600 E 1601/600 KAST.GRAPHIT
0406609	NOGICE ZA ORMARIĆE H = 40 cm (Par)

### NAMJEŠTAJ ELISA 110 BIJELO (WH) - LIJEVI

Š.Vokel	Opis
0406601	TOALETNI ORMARIĆ SA LED SVJETILJKOM TOE 110 WH-L BIJELO LIJEVI
0406603	ORMAR S UMIVAONIKOM OUE 110 WH-L BIJELO LIJEVI
0406605	ORMARIĆ S VRATIMA I LADICOM H = 744 E 741 WH BIJELO
0406613	ORMARIĆ S VRATIMA I LADICOM H = 1600 E 1601 WH BIJELO
0406606	ORMARIĆ S VRATIMA I LADICOM H = 1600/600 E 1601/600 WH BIJELO
0406609	NOGICE ZA ORMARIĆE H = 40 cm (Par)

### elisa 110-L

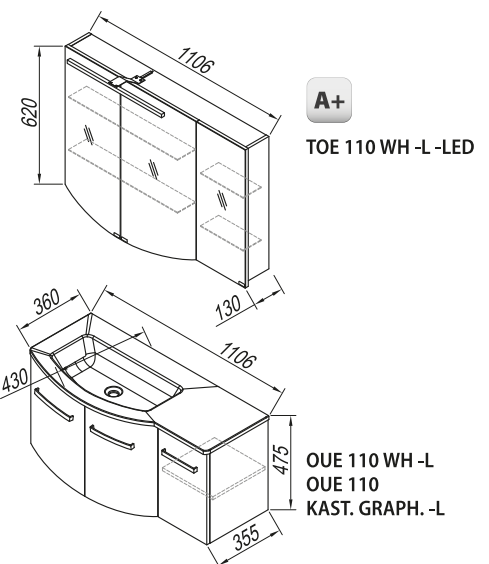

Elisa 110 WH -L  
Elisa 110 KAST. GRAPH. -L



● NOGICE  
h= 400 mm

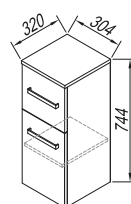

E 741 WH  
E 741 KAST. GRAPH.

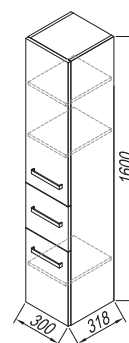

E 1601 WH  
E 1601 KAST. GRAPH.

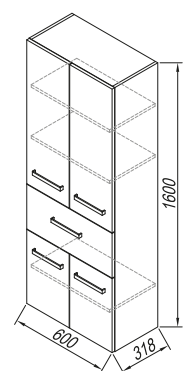

E 1601/600 WH  
E 1601/600 KAST. GRAPH.



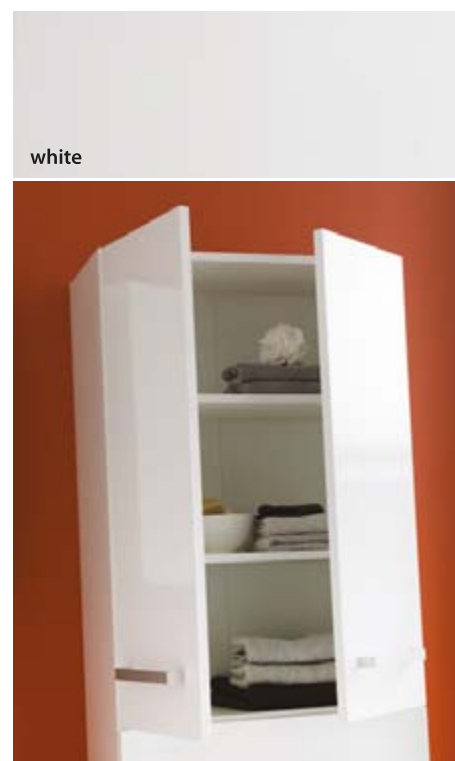

NAMJEŠTAJ ELISA 80 BIJELO (WH)	
Š.Vokel	Opis
0406573	TOALETNI ORMARIĆ SA LED SVJETILJKOM TOE 80 WH BIJELO
0406579	ORMAR S UMIVAONIKOM OUE 80 WH BIJELO
0406605	ORMARIĆ S VRATIMA I LADICOM H = 744 E 741 WH BIJELO
0406613	ORMARIĆ S VRATIMA I LADICOM H = 1600 E 1601 WH BIJELO
0406606	ORMARIĆ S VRATIMA I LADICOM H = 1600/600 E 1601/600 WH BIJELO
0406609	NOGICE ZA ORMARIĆE H = 40 cm (Par)

NAMJEŠTAJ ELISA 80 KASTANIE GRAPHIT (KAST.GRAPH.)	
Š.Vokel	Opis
0406573	TOALETNI ORMARIĆ SA LED SVJETILJKOM TOE 80 WH BIJELO
0406572	ORMAR S UMIVAONIKOM OUE 80 CAST.GRAPH.
0406656	ORMARIĆ S VRATIMA I LADICOM H = 744 E 741 KAST.GRAPHIT
	ORMARIĆ S VRATIMA I LADICOM H = 1600 E 1601 KAST.GRAPHIT
0406615	ORMARIĆ S VRATIMA I LADICOM H = 1600/600 E 1601/600 KAST.GRAPHIT
0406609	NOGICE ZA ORMARIĆE H = 40 cm (Par)

### elisa 80

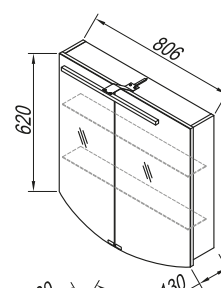

**A+**

TOE 80 WH -LED

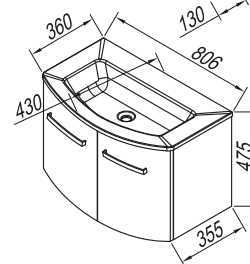

OUE 80 WH  
OUE 80 KAST. GRAPH.

Elisa 80 WH  
Elisa 80 KAST. GRAPH.



• NOGICE  
h= 400 mm

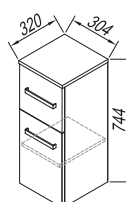

E 741 WH  
E 741 KAST. GRAPH.

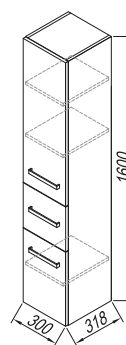

E 1601 WH  
E 1601 KAST. GRAPH.

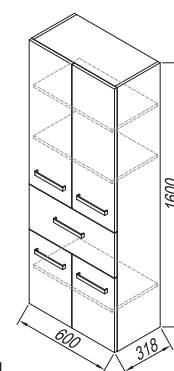

E 1601/600 WH  
E 1601/600 KAST. GRAPH.



NAMJEŠTAJ IMAN 100 BIJELO (WH)	
Š.Vokel	Opis
0406542	OGLEDALO SA NEONSKOM SVJETILJKOM, PREKIDAČEM I UTIČNICOM OGI 100 NEON, SW, S
0406540	TOALETNI ORMARIĆ SA LED SVJETILJKOM, PREKIDAČEM I UTIČNICOM TOI 100 LED, SW, S WH BIJELO
0406541	ORMAR S UMIVAONIKOM OUI 100 WH BIJELO
0406550	ORMARIĆ S VRATIMA H = 1650 I 1650 WH BIJELO
0406547	ORMARIĆ S VRATIMA H = 498 OI 35 WH BIJELO
0406609	NOGICE ZA ORMARIĆE H = 40 cm (Par)

NAMJEŠTAJ IMAN 100 ANTRACIT (ANT)	
Š.Vokel	Opis
0406542	OGLEDALO SA NEONSKOM SVJETILJKOM, PREKIDAČEM I UTIČNICOM OGI 100 NEON, SW, S
0406557	TOALETNI ORMARIĆ SA LED SVJETILJKOM, PREKIDAČEM I UTIČNICOM TOI 100 LED, SW, S ANTRACIT
0406556	ORMAR S UMIVAONIKOM OUI 100 ANTRACIT
0406530	ORMARIĆ S VRATIMA H = 1650 I 1650 ANTRACIT
0406531	ORMARIĆ S VRATIMA H = 498 OI 35 ANTRACIT
0406609	NOGICE ZA ORMARIĆE H = 40 cm (Par)

### iman 100,80

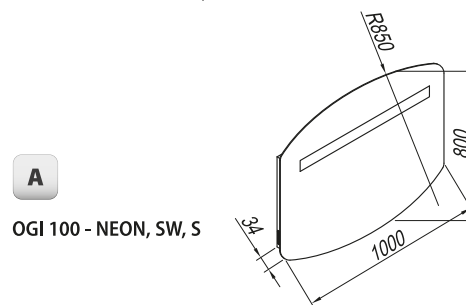

A

OGI 100 - NEON, SW, S

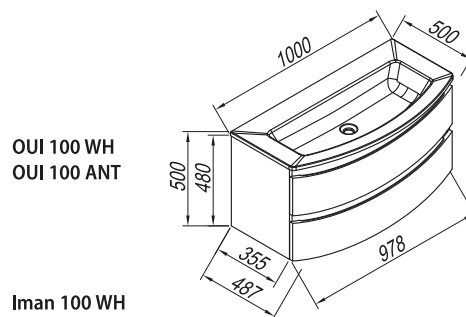

OUI 100 WH  
OUI 100 ANT

Iman 100 WH  
Iman 100 ANT

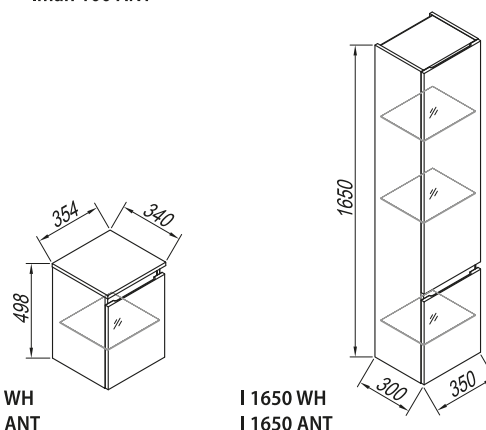

I 1650 WH  
I 1650 ANT



● NOGICE  
h = 400 mm

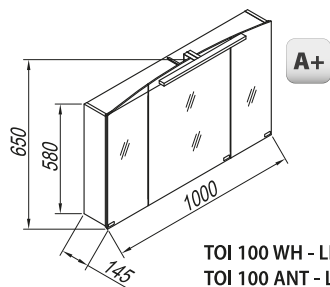

TOI 100 WH - LED, SW, S  
TOI 100 ANT - LED, SW, S

OI 35 WH  
OI 35 ANT



## iman 100, 80

### Fronte:

MDF/lakirana, bijela, antracit (visoki sjaj)

Obod: oplemenjena iverica/  
bijela sjaj, antracit

### Umivaonik:

lijevani mramor

### Svjetlo:

OGI 100: NEON, SW, S: 13/21W

TOI 100: LED, SW, S: 6 W

NAMJEŠTAJ IMAN 80 BIJELO (WH)	
Š.Vokel	Opis
0406533	OGLEDALO SA NEONSKOM SVJETILJKOM, PREKIDAČEM I UTIČNICOM OGI 80 NEON, SW, S
0406526	TOALETNI ORMARIĆ SA LED SVJETILJKOM, PREKIDAČEM I UTIČNICOM TOI 80 LED, SW, S WH BIJELO
0406525	ORMAR S UMIVAONIKOM OUI 80 WH BIJELO
0406550	ORMARIĆ S VRATIMA H = 1650 I 1650 WH BIJELO
0406547	ORMARIĆ S VRATIMA H = 498 OI 35 WH BIJELO
0406609	NOGICE ZA ORMARIĆE H = 40 cm (Par)

A

OGI 80 -NEON, SW, S

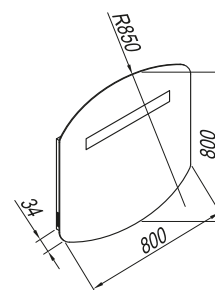

NAMJEŠTAJ IMAN 80 ANTRACIT (ANT)	
Š.Vokel	Opis
0406533	OGLEDALO SA NEONSKOM SVJETILJKOM, PREKIDAČEM I UTIČNICOM OGI 80 NEON, SW, S
0406554	TOALETNI ORMARIĆ SA LED SVJETILJKOM, PREKIDAČEM I UTIČNICOM TOI 80 LED, SW, S ANTRACIT
0406532	ORMAR S UMIVAONIKOM OUI 80 ANTRACIT
0406530	ORMARIĆ S VRATIMA H = 1650 I 1650 ANTRACIT
0406531	ORMARIĆ S VRATIMA H = 498 OI 35 ANTRACIT
0406609	NOGICE ZA ORMARIĆE H = 40 cm (Par)

OUI 80 WH  
OUI 80 ANT

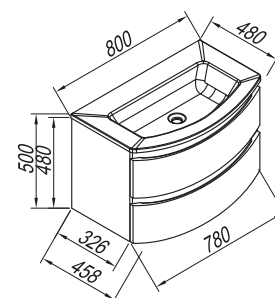

Iman 80 WH  
Iman 80 ANT



● NOGICE  
h= 400 mm

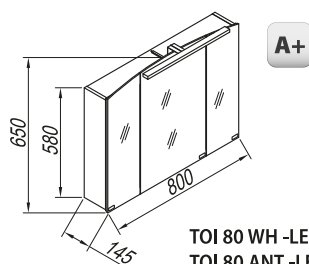

TOI 80 WH -LED, SW, S  
TOI 80 ANT -LED, SW, S

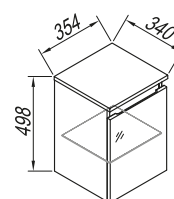

OI 35 WH  
OI 35 ANT

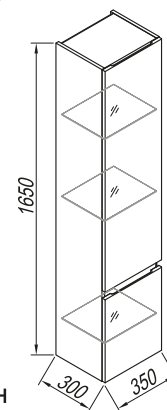

I 1650 WH  
I 1650 ANT



OGA 120 /2 BAMBUS - LED, T

A 1803/20 BAMBUS

OUA 120/2 BAMBUS

## amaya 120/2

**Fronte:**

furnirani MDF - bambus

**Obod:**

furnirani MDF - bambus

**Umivaonik:**

lijevani mramor

**Ručice:** push

**Nožice:** mat

**Svijetlo:** LED, T 16,5 W



NAMJEŠTAJ AMAYA 120/2 BAMBUS	
Š.Vokel	Opis
	OGLEDALO SA POLICOM, INTEGRIRANOM LED SVJETILJKOM I SENZORSKIM PREKIDAČEM OGA 120/2 LED, T BAMBUS
	ORMAR S DVA UMIVAONIKA OUA 120/2 BAMBUS
	ORMARIĆ S VRATIMA H = 1800 A 1803/20 BAMBUS

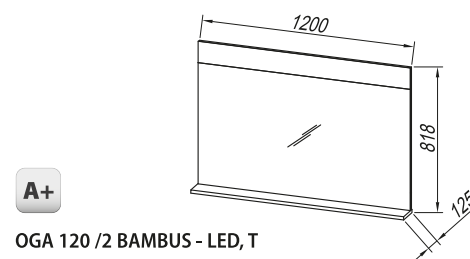

**A+**

OGA 120 /2 BAMBUS - LED, T

OUA 120/2 BAMBUS

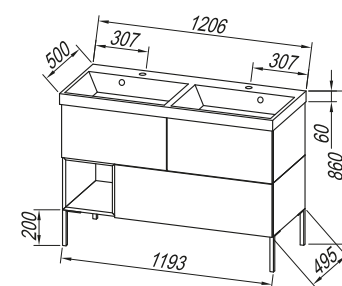

AMAYA 120/2 BAMBUS



A 1803/20 BAMBUS

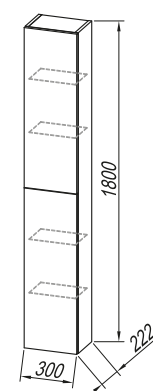





## amaya 60/120

**Fronte:**  
furnirani MDF - bambus

**Obod:**  
furnirani MDF - bambus

**Umivaonik:**  
Ijevani mramor

**Ručice:** push

**Nožice:** mat

**Svijetlo:** LED, T 16,5 W

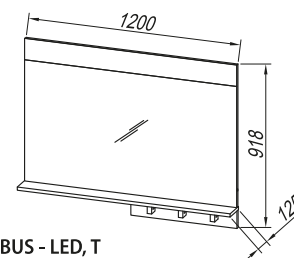

A+

OGA 60/120 BAMBUS - LED, T

OUA 60/120 BAMBUS

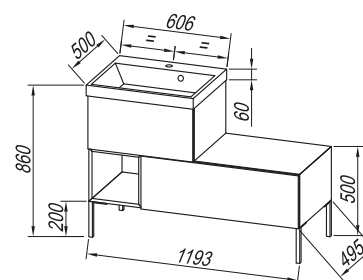

AMAYA 60/120 BAMBUS

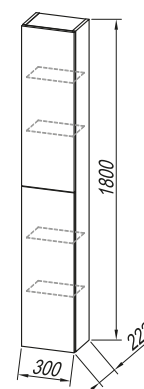

A 1803/20 BAMBUS

NAMJEŠTAJ AMAYA 60/120 BAMBUS	
Š.Vokel	Opis
	OGLEDALO SA POLICOM, VJEŠALICOM, INTEGRIRANOM LED SVJETILJKOM I SENZORSKIM PREKIDAČEM OGA 60/120 LED, T BAMBUS
	ORMAR SA UMIVAONIKOM OUA 60/120 BAMBUS
	ORMARIĆ S VRATIMA H = 1800 A 1803/20 BAMBUS







## oxana 105, 80, 60

**Fronte:** obložen MDF PVC folijom  
- bijela mat (WH), svijetla akacija (acacia light),  
tamni hrast (hacienda BL)

**Obod:** oplemenjena iverica  
- bijela (WH), svijetla akacija (acacia light),  
tamni hrast (hacienda BL)

**Umivaonik:** keramički

**Ručice:** ukopne u fronti

**Svijetlo:**

**OGO 60, 80, 100 LED, T:** 9,5 W / 11,5 W / 13,5 W

**TOO, 60, 80, 100 LED, SW, S:** 7 W

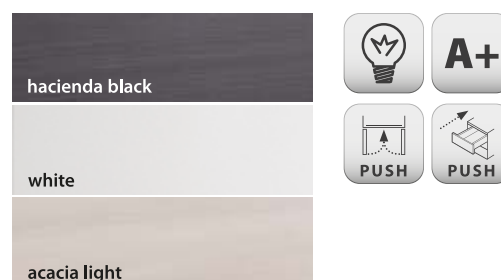

NAMJEŠTAJ OXANA 105 TAMNI HRAST HACIENDA	
Š.Vokel	Opis
0406662	OGLEDALO SA LED SVJETILJKOM I SENZORSKIM PREKIDAČEM OGO 100 LED, T
	TOALETNI ORMARIĆ SA LED SVJETILJKOM, PREKIDAČEM I UTIČNICOM TOO 100 LED, SW, S TAMNI HRAST
0406661	ORMAR S UMIVAONIKOM O 105 TAMNI HRAST
0406662	ORMARIĆ S VRATIMA H = 1753 O 1752 TAMNI HRAST
0406663	ORMARIĆ S VRATIMA H = 954 O 953 TAMNI HRAST
0406571	NOGICE ZA ORMARIĆE H = 20 cm (Par)

NAMJEŠTAJ OXANA 105 BIJELO	
Š.Vokel	Opis
0406662	OGLEDALO SA LED SVJETILJKOM I SENZORSKIM PREKIDAČEM OGO 100 LED, T
0406642	TOALETNI ORMARIĆ SA LED SVJETILJKOM, PREKIDAČEM I UTIČNICOM TOO 100 LED, SW, S BIJELO
0406643	ORMAR S UMIVAONIKOM O 105 BIJELO
0406644	ORMARIĆ S VRATIMA H = 1753 O 1752 BIJELO
0406645	ORMARIĆ S VRATIMA H = 954 O 953 BIJELO
0406571	NOGICE ZA ORMARIĆE H = 20 cm (Par)

NAMJEŠTAJ OXANA 105 SVIJETLA AKACIJA	
Š.Vokel	Opis
0406662	OGLEDALO SA LED SVJETILJKOM I SENZORSKIM PREKIDAČEM OGO 100 LED, T
	TOALETNI ORMARIĆ SA LED SVJETILJKOM, PREKIDAČEM I UTIČNICOM TOO 100 LED, SW, S SVIJETLA AKACIJA
	ORMAR S UMIVAONIKOM O 105 SVIJETLA AKACIJA
	ORMARIĆ S VRATIMA H = 1753 O 1752 SVIJETLA AKACIJA
	ORMARIĆ S VRATIMA H = 954 O 953 SVIJETLA AKACIJA
0406571	NOGICE ZA ORMARIĆE H = 20 cm (Par)

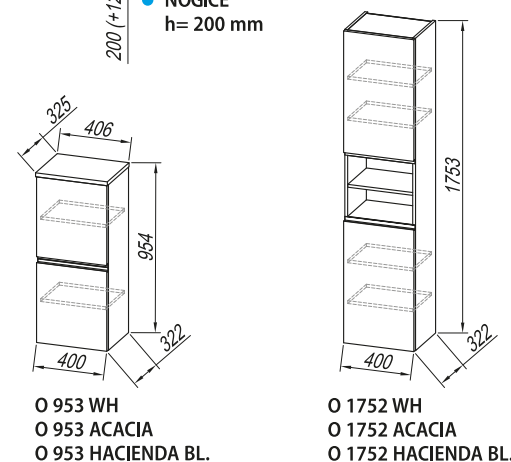
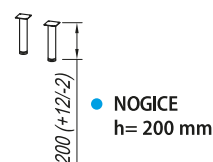
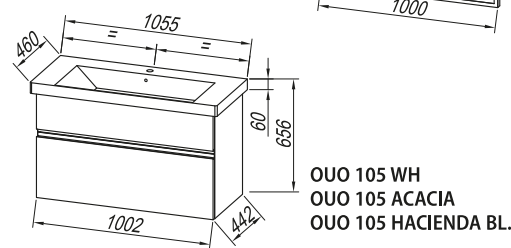
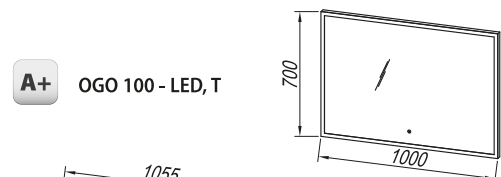
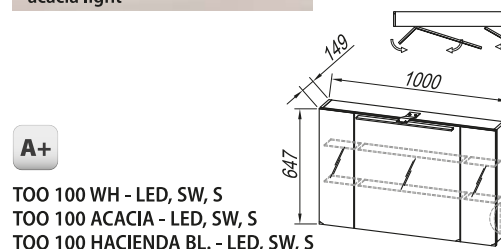



## oxana 105, 80, 60

**Fronte:** obložen MDF PVC folijom  
- bijela mat (WH), svijetla akacija (acacia light),  
tamni hrast (hacienda BL.)

**Obod:** oplemenjena iverica  
- bijela(WH), svijetla akacija (acacia light),  
tamni hrast (hacienda BL.)

**Umivaonik:** keramički

**Ručice:** ukopne u fronti

**Svijetlo:**

**OGO 60, 80, 100 LED, T: 9,5 W / 11,5 W / 13,5 W**

**TOO, 60, 80, 100 LED, SW, S: 7 W**

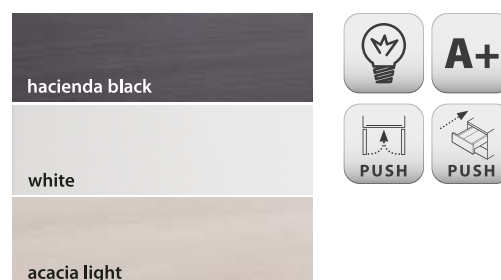

NAMJEŠTAJ OXANA 80 SVIJETLA AKACIJA	
Š.Vokel	Opis
0406631	OGLEDALO SA LED SVJETILJKOM I SENZORSKIM PREKIDAČEM OGO 80 LED, T
	TOALETNI ORMARIĆ SA LED SVJETILJKOM, PREKIDAČEM I UTIČNICOM TOO 80 LED, SW, S SVIJETLA AKACIJA
	ORMAR S UMIVAONIKOM OUO 80 SVIJETLA AKACIJA
	ORMARIĆ S VRATIMA O 1752 SVIJETLA AKACIJA
	ORMARIĆ S VRATIMA O 953 SVIJETLA AKACIJA
0406571	NOGICE ZA ORMARIĆE H = 20 cm (Par)

NAMJEŠTAJ OXANA 80 BIJELO	
Š.Vokel	Opis
0406631	OGLEDALO SA LED SVJETILJKOM I SENZORSKIM PREKIDAČEM OGO 80 LED, T
0406641	TOALETNI ORMARIĆ SA LED SVJETILJKOM, PREKIDAČEM I UTIČNICOM TOO 80 LED, SW, S BIJELO
0406640	ORMAR S UMIVAONIKOM OUO 80 BIJELO
0406644	ORMARIĆ S VRATIMA O 1752 BIJELO
0406645	ORMARIĆ S VRATIMA O 953 BIJELO
0406571	NOGICE ZA ORMARIĆE H = 20 cm (Par)

NAMJEŠTAJ OXANA 80 TAMNI HRAST	
Š.Vokel	Opis
0406631	OGLEDALO SA LED SVJETILJKOM I SENZORSKIM PREKIDAČEM OGO 80 LED, T
0406664	TOALETNI ORMARIĆ SA LED SVJETILJKOM, PREKIDAČEM I UTIČNICOM TOO 80 LED, SW, S TAMNI HRAST
0406632	ORMAR S UMIVAONIKOM OUO 80 TAMNI HRAST
0406667	ORMARIĆ S VRATIMA O 1752 TAMNI HRAST
0406663	ORMARIĆ S VRATIMA O 953 TAMNI HRAST
0406571	NOGICE ZA ORMARIĆE H = 20 cm (Par)

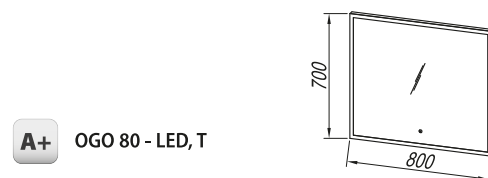

**A+** OGO 80 - LED, T

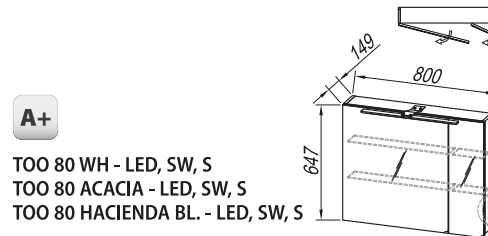

**A+**  
TOO 80 WH - LED, SW, S  
TOO 80 ACACIA - LED, SW, S  
TOO 80 HACIENDA BL. - LED, SW, S

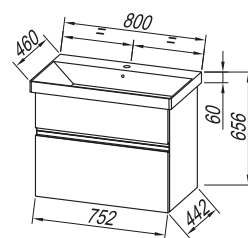

OUO 80 WH  
OUO 80 ACACIA LIGHT  
OUO 80 HACIENDA BL.

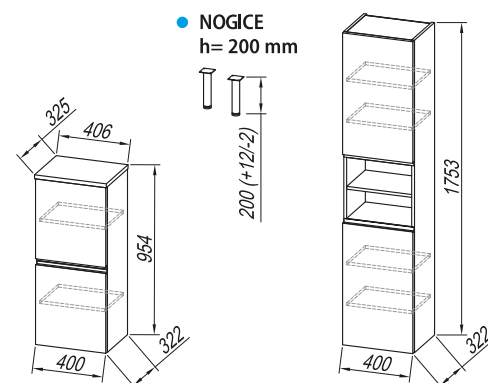

● NOGICE  
h= 200 mm  
O 953 WH  
O 953 ACACIA  
O 953 HACIENDA BL.

O 1752 WH  
O 1752 ACACIA  
O 1752 HACIENDA BL.



## oxana 105, 80, 60

**Fronte:** obložen MDF PVC folijom  
- bijela mat (WH), svijetla akacija (acacia light),  
tamni hrast (hacienda BL)

**Obod:** oplemenjena iverica  
- bijela(WH), svijetla akacija (acacia light),  
tamni hrast (hacienda BL)

**Umivaonik:** keramički

**Ručice:** ukopne u fronti

**Svijetlo:**

**OGO 60, 80, 100 LED, T:** 9,5 W / 11,5 W / 13,5 W

**TOO, 60, 80, 100 LED, SW, S:** 7 W

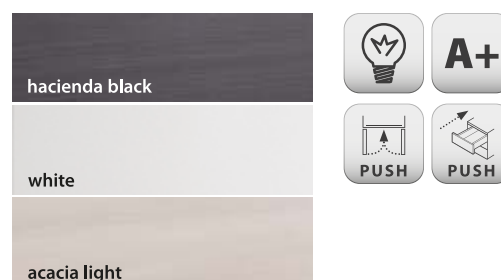

NAMJEŠTAJ OXANA 60 BIJELO	
Š.Vokel	Opis
0406659	OGLEDALO SA LED SVJETILJKOM I SENZORSKIM PREKIDAČEM OGO 60 LED, T
	TOALETNI ORMARIĆ SA LED SVJETILJKOM, PREKIDAČEM I UTIČNICOM TOO 60 LED, SW, S BIJELO
0406658	ORMAR S UMIVAONIKOM O 953 BIJELO
0406644	ORMARIĆ S VRATIMA O 1752 BIJELO
0406645	ORMARIĆ S VRATIMA O 953 BIJELO
0406571	NOGICE ZA ORMARIĆE H = 20 cm (Par)

NAMJEŠTAJ OXANA 60 SVIJETLA AKACIJA	
Š.Vokel	Opis
0406659	OGLEDALO SA LED SVJETILJKOM I SENZORSKIM PREKIDAČEM OGO 60 LED, T
	TOALETNI ORMARIĆ SA LED SVJETILJKOM, PREKIDAČEM I UTIČNICOM TOO 60 LED, SW, S SVIJETLA AKACIJA
	ORMAR S UMIVAONIKOM O 953 SVIJETLA AKACIJA
	ORMARIĆ S VRATIMA O 1752 SVIJETLA AKACIJA
	ORMARIĆ S VRATIMA O 953 SVIJETLA AKACIJA
0406571	NOGICE ZA ORMARIĆE H = 20 cm (Par)

NAMJEŠTAJ OXANA 60 TAMNI HRAS	
Š.Vokel	Opis
0406659	OGLEDALO SA LED SVJETILJKOM I SENZORSKIM PREKIDAČEM OGO 60 LED, T
0406666	TOALETNI ORMARIĆ SA LED SVJETILJKOM, PREKIDAČEM I UTIČNICOM TOO 60 LED, SW, S TAMNI HRAS
0406665	ORMAR S UMIVAONIKOM O 953 TAMNI HRAS
0406667	ORMARIĆ S VRATIMA O 1752 TAMNI HRAS
0406663	ORMARIĆ S VRATIMA O 953 TAMNI HRAS
0406571	NOGICE ZA ORMARIĆE H = 20 cm (Par)

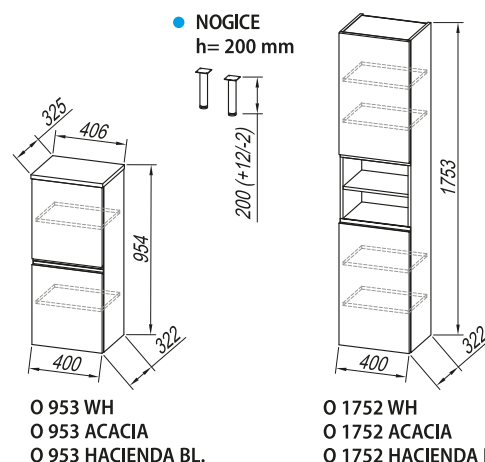
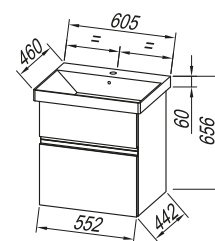
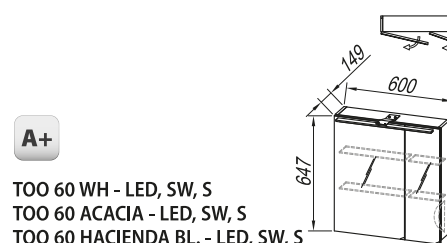
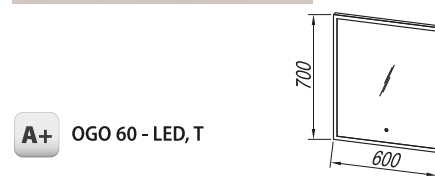



## zena 120, 100, 80, 60

### Fronte:

oplemenjena iverica /  
lakirana, bijela (visoki sjaj),  
starani hrast - BARDOLINO

### Obod:

oplemenjena iverica /  
bijela sjaj, starani hrast - BARDOLINO

Umivaonik: Kerrock

Ručice: mat

Osvjetljenje: LED, SW, S: 7 W

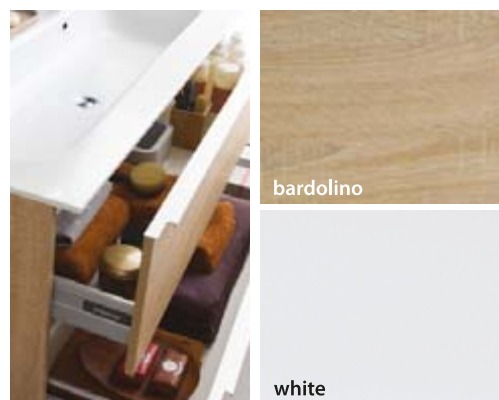

NAMJEŠTAJ ZENA 120 STARI HRAST (BARDOLINO)	
Š.Vokel	Opis
0406586	TOALETNI ORMARIĆ SA LED SVJETILJKOM, PREKIDAČEM I UTIČNICOM TOZ 120 LED, SW, S BARD STARI HRAST
0406587	ORMAR S UMIVAONIKOM OUZ 120 BARD STARI HRAST
0406647	ORMARIĆ S VRATIMA H = 600 Z 602 BARD STARI HRAST
0406588	ORMARIĆ OTVORENI H = 1800 Z 1800 BARD STARI HRAST
0406543	ORMARIĆ S VRATIMA H = 1800 Z 1802 BARD STARI HRAST
0406571	NOGICE ZA ORMARIĆE H = 20 cm (Par)
0406481	KOŠ ZA RUBLJE ZENA

NAMJEŠTAJ ZENA 120 BIJELO (WH)	
Š.Vokel	Opis
0406580	TOALETNI ORMARIĆ SA LED SVJETILJKOM, PREKIDAČEM I UTIČNICOM TOZ 120 LED, SW, S WH BIJELO
0406589	ORMAR S UMIVAONIKOM OUZ 120 WH BIJELO
0406612	ORMARIĆ S VRATIMA H = 600 Z 602 WH BIJELO
0406534	ORMARIĆ OTVORENI H = 1800 Z 1800 WH BIJELO
0406535	ORMARIĆ S VRATIMA H = 1800 Z 1802 WH BIJELO
0406571	NOGICE ZA ORMARIĆE H = 20 cm (Par)
0406481	KOŠ ZA RUBLJE ZENA

A+

TOZ 120 WH -LED, SW, S  
TOZ 120 BARD -LED, SW, S

Ouz 120 WH  
Ouz 120 BARD

Zena 120 WH  
Zena 120 BARD

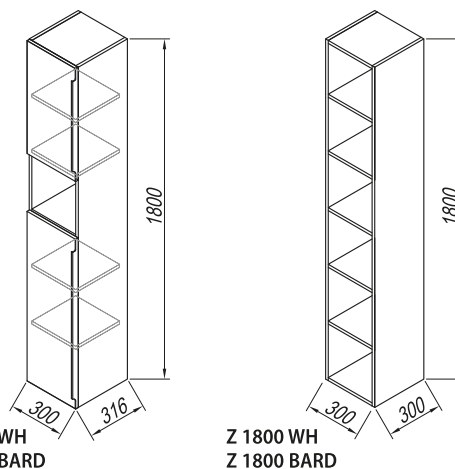
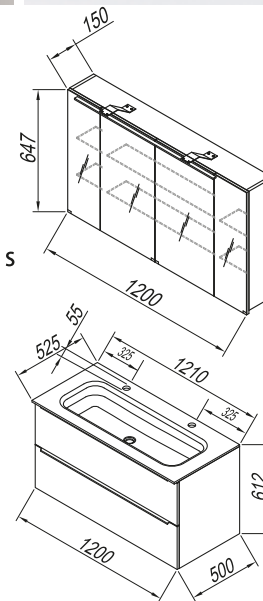

● NOGICE  
h = 200 mm  
200 (+12-2)

● KOŠ ZENA  
500  
230  
250

Z 602 WH  
Z 602 BARD  
600  
300  
316

Z 1802 WH  
Z 1802 BARD

Z 1800 WH  
Z 1800 BARD



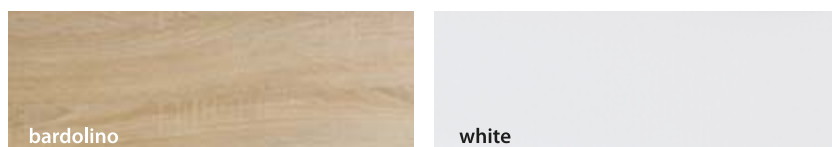

NAMJEŠTAJ ZENA 100 BIJELO (WH)	
Š.Vokel	Opis
0406537	TOALETNI ORMARIĆ SA LED SVJETILJKOM, PREKIDAČEM I UTIČNICOM TOZ 100 LED, SW, S WH BIJELO
0406536	ORMAR S UMIVAONIKOM OUZ 100 WH BIJELO
0406612	ORMARIĆ S VRATIMA H = 600 Z 602 WH BIJELO
0406534	ORMARIĆ OTVORENI H = 1800 Z 1800 WH BIJELO
0406535	ORMARIĆ S VRATIMA H = 1800 Z 1802 WH BIJELO
0406571	NOGICE ZA ORMARIĆE H = 20 cm (Par)
0406481	KOŠ ZA RUBLJE ZENA

NAMJEŠTAJ ZENA 100 STARI HRAST (BARDOLINO)	
Š.Vokel	Opis
0406545	TOALETNI ORMARIĆ SA LED SVJETILJKOM, PREKIDAČEM I UTIČNICOM TOZ 100 LED, SW, S BARD STARI HRAST
0406546	ORMAR S UMIVAONIKOM OUZ 100 BARD STARI HRAST
0406647	ORMARIĆ S VRATIMA H = 600 Z 602 BARD STARI HRAST
0406588	ORMARIĆ OTVORENI H = 1800 Z 1800 BARD STARI HRAST
0406543	ORMARIĆ S VRATIMA H = 1800 Z 1802 BARD STARI HRAST
0406571	NOGICE ZA ORMARIĆE H = 20 cm (Par)
0406481	KOŠ ZA RUBLJE ZENA

### zena 120, 100, 80, 60

A+

TOZ 100 WH -LED, SW, S  
TOZ 100 BARD -LED, SW, S

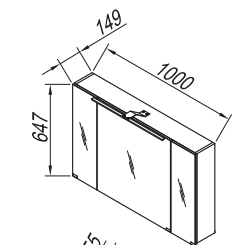

Ouz 100 WH  
Ouz 100 BARD

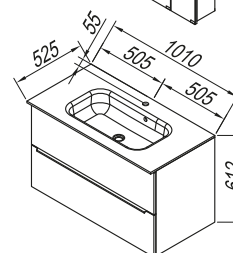

Zena 100 WH  
Zena 100 BARD

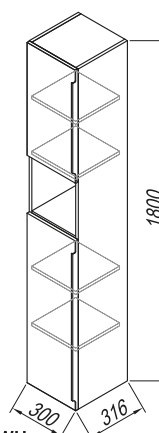

Z 1802 WH  
Z 1802 BARD

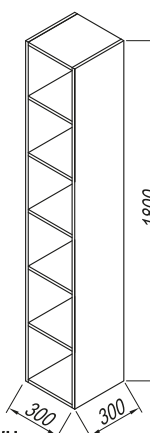

Z 1800 WH  
Z 1800 BARD

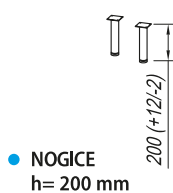

● NOGICE  
h = 200 mm

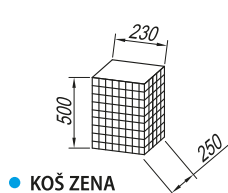

● KOŠ ZENA

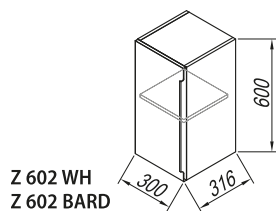

Z 602 WH  
Z 602 BARD





## zena 80

### Fronte:

oplemenjena iverica /  
lakirana, bijela (visoki sjaj),  
starani hrast - BARDOLINO

### Obod:

oplemenjena iverica /  
bijela sjaj, starani hrast - BARDOLINO

**Umivaonik:** Kerrock

**Ručice:** mat

**Osvjetljenje:** LED, SW, S: 7 W

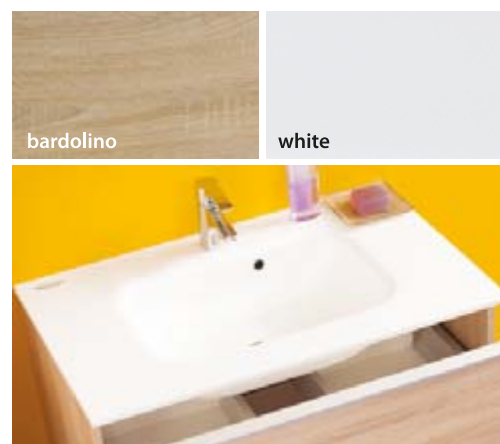

NAMJEŠTAJ ZENA 80 BIJELO (WH)	
Š.Vokel	Opis
0406538	TOALETNI ORMARIĆ SA LED SVJETILJKOM, PREKIDAČEM I UTIČNICOM TOZ 80 LED, SW, S WH BIJELO
0406539	ORMAR S UMIVAONIKOM OUZ 80 WH BIJELO
0406612	ORMARIĆ S VRATIMA H = 600 Z 602 WH BIJELO
0406534	ORMARIĆ OTVORENI H = 1800 Z 1800 WH BIJELO
0406535	ORMARIĆ S VRATIMA H = 1800 Z 1802 WH BIJELO
0406571	NOGICE ZA ORMARIĆE H = 20 cm (Par)
0406481	KOŠ ZA RUBLJE ZENA

NAMJEŠTAJ ZENA 80 STARI HRAST (BARDOLINO)	
Š.Vokel	Opis
0406552	TOALETNI ORMARIĆ SA LED SVJETILJKOM, PREKIDAČEM I UTIČNICOM TOZ 80 LED, SW, S BARD STARI HRAST
0406551	ORMAR S UMIVAONIKOM OUZ 80 BARD STARI HRAST
0406647	ORMARIĆ S VRATIMA H = 600 Z 602 BARD STARI HRAST
0406588	ORMARIĆ OTVORENI H = 1800 Z 1800 BARD STARI HRAST
0406543	ORMARIĆ S VRATIMA H = 1800 Z 1802 BARD STARI HRAST
0406571	NOGICE ZA ORMARIĆE H = 20 cm (Par)
0406481	KOŠ ZA RUBLJE ZENA

**A+**

TOZ 80 WH  
TOZ 80 BARD

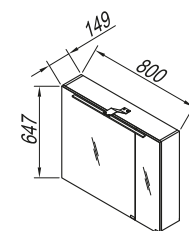

OUZ 80 WH  
OUZ 80 BARD

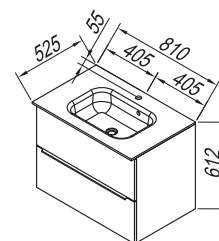

Zena 80 WH  
Zena 80 BARD

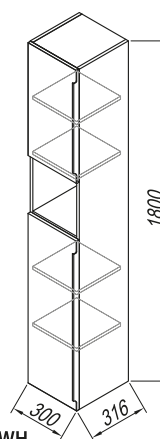

Z 1802 WH  
Z 1802 BARD

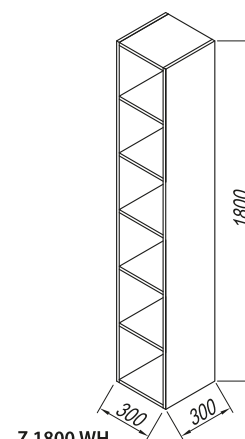

Z 1800 WH  
Z 1800 BARD



● NOGICE  
h = 200 mm

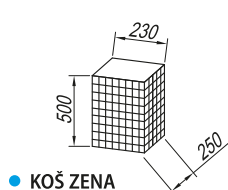

● KOŠ ZENA

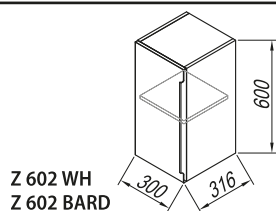

Z 602 WH  
Z 602 BARD



NAMJEŠTAJ ZENA 60 STARI HRAS (BARDOLINO)	
Š.Vokel	Opis
	TOALETNI ORMARIĆ SA LED SVJETILJKOM, PREKIDAČEM I UTIČNICOM TOZ 60 LED, SW, S BARD STARI HRAS
	ORMAR S UMIVAONIKOM OUZ 60 BARD STARI HRAS
	ORMARIĆ S VRATIMA H = 600 Z 602 BARD STARI HRAS
	ORMARIĆ OTVORENI H = 1800 Z 1800 BARD STARI HRAS
	ORMARIĆ S VRATIMA H = 1800 Z 1802 BARD STARI HRAS
0406571	NOGICE ZA ORMARIĆE H = 20 cm (Par)
0406481	KOŠ ZA RUBLJE ZENA

NAMJEŠTAJ ZENA 60 BIJELO (WH)	
Š.Vokel	Opis
0406558	TOALETNI ORMARIĆ SA LED SVJETILJKOM, PREKIDAČEM I UTIČNICOM TOZ 60 LED, SW, S WH BIJELO
0406559	ORMAR S UMIVAONIKOM OUZ 60 WH BIJELO
0406612	ORMARIĆ S VRATIMA H = 600 Z 602 WH BIJELO
0406534	ORMARIĆ OTVORENI H = 1800 Z 1800 WH BIJELO
0406535	ORMARIĆ S VRATIMA H = 1800 Z 1802 WH BIJELO
0406571	NOGICE ZA ORMARIĆE H = 20 cm (Par)
0406481	KOŠ ZA RUBLJE ZENA

**zena 60**

A+

TOZ 60 WH  
TOZ 60 BARD

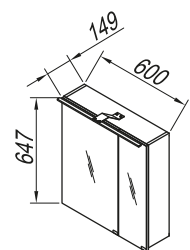

Ouz 60 WH  
Ouz 60 BARD

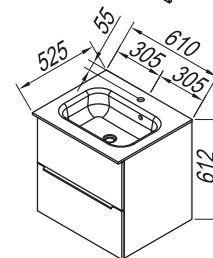

Zena 60 WH  
Zena 60 BARD

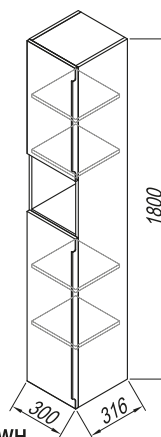

Z 1802 WH  
Z 1802 BARD

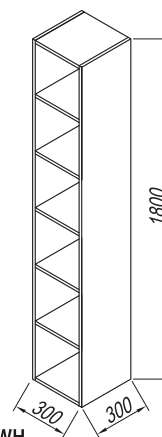

Z 1800 WH  
Z 1800 BARD

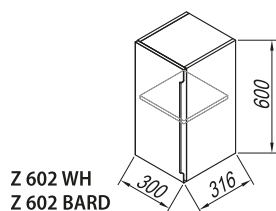
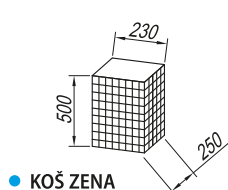
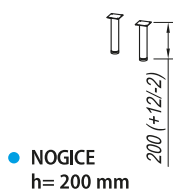

## jolie 120, 90, 60



### Fronte:

obložen MDF PVC folijom - WH, CHA, DW;  
MDF lakiran - ANT

### Obod:

Oplemenjena iverna ploča: bijela sjaj, antracit,  
champagne, driftwood.

**Umivaonik:** lijevani mramor

**Ručice:** Mat

### Osvjetljenje:

OGJ 60, 90, 120: NEON, SW, S - 13W, 21W, 28W

Svjetlo Jolie: LED, SW, S: 7W

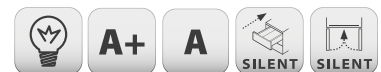

### Standardne kombinacije boja ormarića

(boja fronte/boja oboda):

**Boja:** Bijela (WH), antracit (ANT),  
champagne (CHA), driftwood (DW)



Po narudžbi moguća je izrada i ostalih kombinacija boja

## jolie 120, 90, 60

NAMJEŠTAJ JOLIE 120 BIJELO (WH)	
Š.Vokel	Opis
0406473	OGLEDALO SA NEON SVJETILJKOM, PREKIDAČEM I UTIČNICOM OGJ 120 NEON, SW, S WH BIJELO
0406474	TOALETNI ORMARIĆ TOJ 120 WH BIJELO
0406475	ORMAR S UMIVAONIKOM OUJ 120 WH BIJELO
0406517	ORMAR S DVA UMIVAONIKA OUJ 120/2 WH BIJELO

NAMJEŠTAJ JOLIE 120 ANTRACIT (ANT)	
Š.Vokel	Opis
0406473	OGLEDALO SA NEON SVJETILJKOM, PREKIDAČEM I UTIČNICOM OGJ 120 NEON, SW, S
0406503	TOALETNI ORMARIĆ TOJ 120 ANTRACIT
0406560	ORMAR S UMIVAONIKOM OUJ 120 ANTRACIT
0406504	ORMAR S DVA UMIVAONIKA OUJ 120/2 ANTRACIT

NAMJEŠTAJ JOLIE 120 BOJA ŠAMPANJCA (CHA)	
Š.Vokel	Opis
0406473	OGLEDALO SA NEON SVJETILJKOM, PREKIDAČEM I UTIČNICOM OGJ 120 NEON, SW, S
	TOALETNI ORMARIĆ TOJ 120 BOJA ŠAMPANJCA
	ORMAR S UMIVAONIKOM OUJ 120 BOJA ŠAMPANJCA
	ORMAR S DVA UMIVAONIKA OUJ 120/2 BOJA ŠAMPANJCA

NAMJEŠTAJ JOLIE 120 DRIFTWOOD (DW)	
Š.Vokel	Opis
0406473	OGLEDALO SA NEON SVJETILJKOM, PREKIDAČEM I UTIČNICOM OGJ 120 NEON, SW, S
0406513	TOALETNI ORMARIĆ TOJ 120 DRIFTWOOD
0406512	ORMAR S UMIVAONIKOM OUJ 120 DRIFTWOOD
	ORMAR S DVA UMIVAONIKA OUJ 120/2 DRIFTWOOD



jolie 120/2 - WH/WH



jolie 120 - WH/CHA



jolie 120 - CHA/CHA

**Napomena:**

Mogućnost narudžbe raznih kombinacija fronti/oboda.



**jolie** 120, 90, 60

NAMJEŠTAJ JOLIE 90 BIJELO (WH)	
Š.Vokel	Opis
0406458	OGLEDALO SA NEON SVJETILJKOM, PREKIDAČEM I UTIČNICOM OGJ 90 NEON, SW, S
0406484	TOALETNI ORMARIĆ TOJ 90 WH BIJELO
0406480	ORMAR S UMIVAONIKOM OUJ 90 WH BIJELO

NAMJEŠTAJ JOLIE 90 ANTRACIT (ANT)	
Š.Vokel	Opis
0406458	OGLEDALO SA NEON SVJETILJKOM, PREKIDAČEM I UTIČNICOM OGJ 90 NEON, SW, S
0406454	TOALETNI ORMARIĆ TOJ 90 ANTRACIT
0406459	ORMAR S UMIVAONIKOM OUJ 90 ANTRACIT

NAMJEŠTAJ JOLIE 90 BOJA ŠAMPANJCA (CHA)	
Š.Vokel	Opis
0406458	OGLEDALO SA NEON SVJETILJKOM, PREKIDAČEM I UTIČNICOM OGJ 90 NEON, SW, S
0406466	TOALETNI ORMARIĆ TOJ 90 BOJA ŠAMPANJCA
0406468	ORMAR S UMIVAONIKOM OUJ 90 BOJA ŠAMPANJCA

NAMJEŠTAJ JOLIE 90 DRIFTWOOD (DW)	
Š.Vokel	Opis
0406458	OGLEDALO SA NEON SVJETILJKOM, PREKIDAČEM I UTIČNICOM OGJ 90 NEON, SW, S
0406514	TOALETNI ORMARIĆ TOJ 90 DRIFTWOOD
0406464	ORMAR S UMIVAONIKOM OUJ 90 DRIFTWOOD



**jolie** 90 - DW/DW



**jolie** 90 - WH/WH



**jolie** 90 - WH/DW

**Napomena:**

Mogućnost narudžbe raznih kombinacija fronti/oboda.



**jolie** 120, 90, 60

NAMJEŠTAJ JOLIE 60 BIJELO (WH)	
Š.Vokel	Opis
0406470	OGLEDALO SA NEON SVJETILJKOM, PREKIDAČEM I UTIČNICOM OGJ 60 NEON, SW, S
0406472	TOALETNI ORMARIĆ TOJ 60 WH BIJELO
0406471	ORMAR S UMIVAONIKOM OUJ 60 WH BIJELO

NAMJEŠTAJ JOLIE 60 ANTRACIT (ANT)	
Š.Vokel	Opis
0406470	OGLEDALO SA NEON SVJETILJKOM, PREKIDAČEM I UTIČNICOM OGJ 60 NEON, SW, S
0406462	TOALETNI ORMARIĆ TOJ 60 ANTRACIT
0406463	ORMAR S UMIVAONIKOM OUJ 60 ANTRACIT

NAMJEŠTAJ JOLIE 60 BOJA ŠAMPANJCA (CHA)	
Š.Vokel	Opis
0406470	OGLEDALO SA NEON SVJETILJKOM, PREKIDAČEM I UTIČNICOM OGJ 60 NEON, SW, S
	TOALETNI ORMARIĆ TOJ 60 BOJA ŠAMPANJCA
0406561	ORMAR S UMIVAONIKOM OUJ 60 BOJA ŠAMPANJCA

NAMJEŠTAJ JOLIE 60 DRIFTWOOD (DW)	
Š.Vokel	Opis
0406470	OGLEDALO SA NEON SVJETILJKOM, PREKIDAČEM I UTIČNICOM OGJ 60 NEON, SW, S
0406660	TOALETNI ORMARIĆ TOJ 60 DRIFTWOOD
0406477	ORMAR S UMIVAONIKOM OUJ 60 DRIFTWOOD



**Napomena:**

Mogućnost narudžbe raznih kombinacija fronti/oboda.

# Mogućnost slaganja raznih kombinacija **jolie**



## JOLIE - Elementi

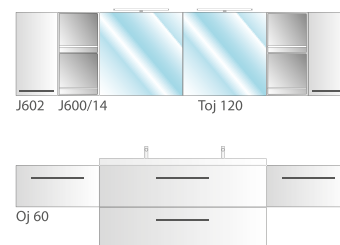
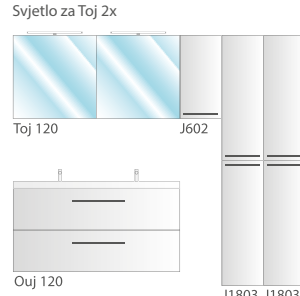
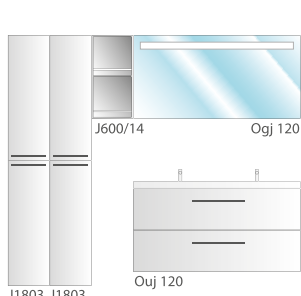
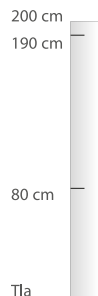
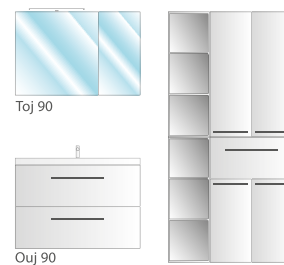
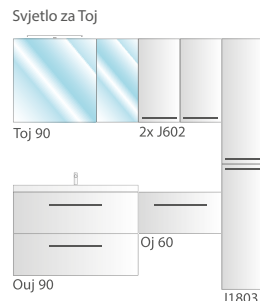
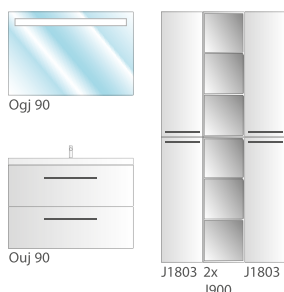
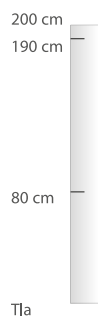
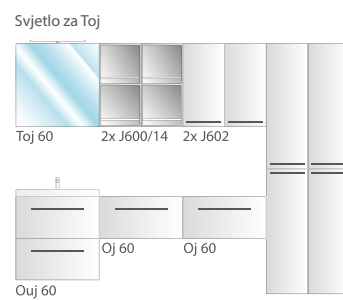
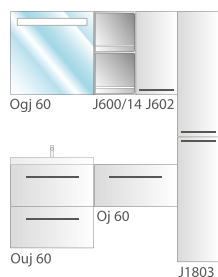
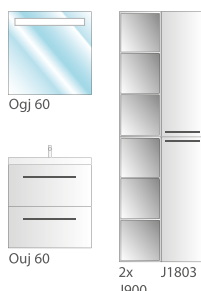
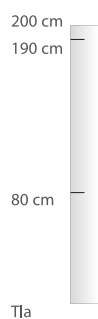



TOJ 120 - 120 x 16 x 62



TOJ 90 - 90 x 16 x 62



TOJ 60 - 60 x 16 x 62



OUJ 60 - 60,6 x 50 x 66



J602 - 30 x 32 x 60  
J600/14 - 30 x 14 x 60



J900/14 - 30 x 14 x 90  
J902/14 - 30 x 16 x 90



OJ 60 - 60 x 49,5 x 30



J902 - 30 x 32 x 90  
J900 - 30 x 30 x 90



J1803 - 30 x 32 x 180  
J1801/600 - 60 x 32 x 180



- Završna polica za ormariće J602, J900, J902 i J1803



- Svjetlo za Toj: LED 7W

- NOGICE h = 200 mm

- Koš za rublje

- KOŠ JOLIE

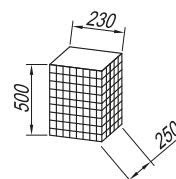



NAMJEŠTAJ UMA 90 BIJELO 3D (WH/3D)	
Š.Vokel	Opis
0406597	TOALETNI ORMARIĆ TOU 90 WH BIJELO
0406600	ORMAR S UMIVAONIKOM OUU 90 WH/3D BIJELO 3D
0406674	ORMARIĆ S VRATIMA H = 900 U 902 WH/3D BIJELO 3D
0406617	ORMARIĆ S VRATIMA I LADICOM H = 900 U 1501 WH/3D BIJELO 3D
0406675	LED SVJETILJKA S PREKIDAČEM I UTIČNICOM ZA TOALETNI ORMARIĆ TOU
0406609	NOGICE ZA ORMARIĆE H = 40 cm (Par)

NAMJEŠTAJ UMA 90 BIJELO (WH)	
Š.Vokel	Opis
0406597	TOALETNI ORMARIĆ TOU 90 WH BIJELO
0406598	ORMAR S UMIVAONIKOM OUU 90 WH BIJELO
0406607	ORMARIĆ S VRATIMA H = 900 U 902 WH BIJELO
0406608	ORMARIĆ S VRATIMA I LADICOM H = 900 U 1501 WH BIJELO
0406675	LED SVJETILJKA S PREKIDAČEM I UTIČNICOM ZA TOALETNI ORMARIĆ TOU
0406609	NOGICE ZA ORMARIĆE H = 40 cm (Par)

uma 90



A+

TOU 90 WH

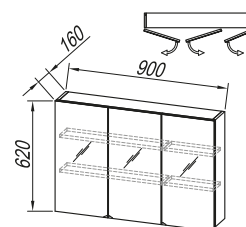

Ouu 90 WH  
Ouu 90 WH 3D

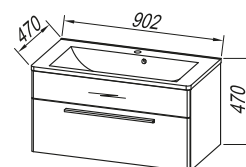

Uma 90 WH  
Uma 90 WH 3D

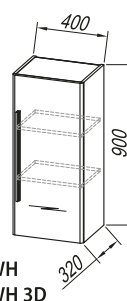

U 902 WH  
U 902 WH 3D

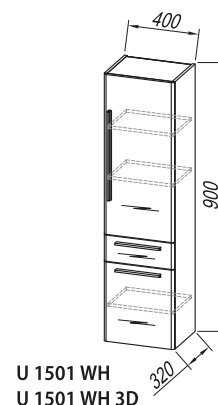

U 1501 WH  
U 1501 WH 3D



● SVJETLO UMA



● NOGICE  
h = 400 mm



NAMJEŠTAJ UMA 60 BIJELO 3D (WH/3D)	
Š.Vokel	Opis
0406574	TOALETNI ORMARIĆ TOU 60 WH BIJELO
0406575	ORMAR S UMIVAONIKOM OUU 60 WH/3D RELJEFNI BIJELO
0406674	ORMARIĆ S VRATIMA H = 900 U 902 WH/3D RELJEFNI BIJELO
0406617	ORMARIĆ S VRATIMA I LADICOM H = 900 U 1501 WH/3D RELJEFNI BIJELO
0406675	LED SVJETILJKA S PREKIDAČEM I UTIČNICOM ZA TOALETNI ORMARIĆ TOU
0406609	NOGICE ZA ORMARIĆE H = 40 cm (Par)

NAMJEŠTAJ UMA 60 BIJELO (WH)	
Š.Vokel	Opis
0406574	TOALETNI ORMARIĆ TOU 60 WH BIJELO
0406599	ORMAR S UMIVAONIKOM OUU 60 WH BIJELO
0406607	ORMARIĆ S VRATIMA H = 900 U 902 WH BIJELO
0406608	ORMARIĆ S VRATIMA I LADICOM H = 900 U 1501 WH BIJELO
0406675	LED SVJETILJKA S PREKIDAČEM I UTIČNICOM ZA TOALETNI ORMARIĆ TOU
0406609	NOGICE ZA ORMARIĆE H = 40 cm (Par)

## uma 60



**Fronte:**  
obložen MDF PVC folijom - bijela, bijela 3D (visoki sjaj)

**Obod:**  
oplemenjena iverica /bijela, sjaj

**Umivaonik:** lijevani mramor

**Ručice:** mat

**Svijetlo:** LED, SW, S: 4,5 W

**A+**

TOU 60 WH

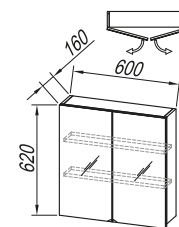

OUU 60 WH  
OUU 60 WH 3D

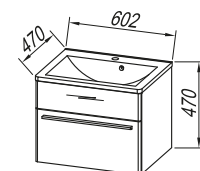

Uma 60 WH  
Uma 60 WH 3D

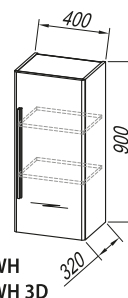

U 902 WH  
U 902 WH 3D

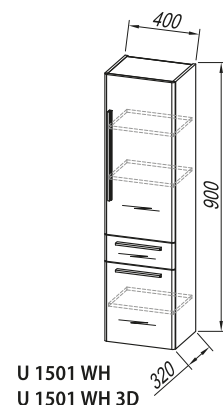

U 1501 WH  
U 1501 WH 3D



● SVJETLO UMA



● NOGICE  
h= 400 mm





NAMJEŠTAJ VIVA 70 BIJELO (WH)	
Š.Vokel	Opis
0406565	OGLEDALO S POLICOM OGV 70 WH BIJELO
0406563	TOALETNI ORMARIĆ TOV 70 WH BIJELO
0406564	ORMAR S UMIVAONIKOM OUV 70 WH BIJELO
0406627	ORMARIĆ S VRATIMA V 652/14 WH BIJELO
0406646	ORMARIĆ S VRATIMA V 652 WH BIJELO
	ORMARIĆ S VRATIMA I LADICOM H= 814 V 811 WH BIJELO
0406619	ORMARIĆ S VRATIMA I LADICOM H= 1750 V 1751 WH BIJELO
	ORMARIĆ S VRATIMA H= 1750 V 1753 WH BIJELO

NAMJEŠTAJ VIVA 70 SIVO (MANH)	
Š.Vokel	Opis
	OGLEDALO S POLICOM OGV 70 SIVO (MANH)
	TOALETNI ORMARIĆ TOV 70 SIVO (MANH)
0406636	ORMAR S UMIVAONIKOM OUV 70 SIVO (MANH)
	ORMARIĆ S VRATIMA V 652/14 SIVO (MANH)
	ORMARIĆ S VRATIMA V 652 SIVO (MANH)
	ORMARIĆ S VRATIMA I LADICOM V 811 SIVO (MANH)
	ORMARIĆ S VRATIMA I LADICOM V 1751 SIVO (MANH)
	ORMARIĆ S VRATIMA 1753 70 SIVO (MANH)

NAMJEŠTAJ VIVA 70 BEŽ (BEIGE)	
Š.Vokel	Opis
	OGLEDALO S POLICOM OGV 70 BEŽ (BEIGE)
	TOALETNI ORMARIĆ TOV 70 BEŽ (BEIGE)
	ORMAR S UMIVAONIKOM OUV 70 BEŽ (BEIGE)
0406624	ORMARIĆ S VRATIMA V 652/14 BEŽ (BEIGE)
	ORMARIĆ S VRATIMA V 652 BEŽ (BEIGE)
0406623	ORMARIĆ S VRATIMA I LADICOM H= 814 V 811 BEŽ (BEIGE)
	ORMARIĆ S VRATIMA I LADICOM H= 1750 V 1751 BEŽ (BEIGE)
	ORMARIĆ S VRATIMA H= 1750 V 1753 BEŽ (BEIGE)

0406655	LED 300 SVJETILJKA BEZ UTIČNICE I PREKIDAČA ZA TOV I OGV
0406654	LED 45 SVJETILJKA BEZ UTIČNICE I PREKIDAČA ZA TOV I OGV
0406583	KOŠ ZA RUBLJE
0406567	NOGICE VIVA H= 15 cm (Par)

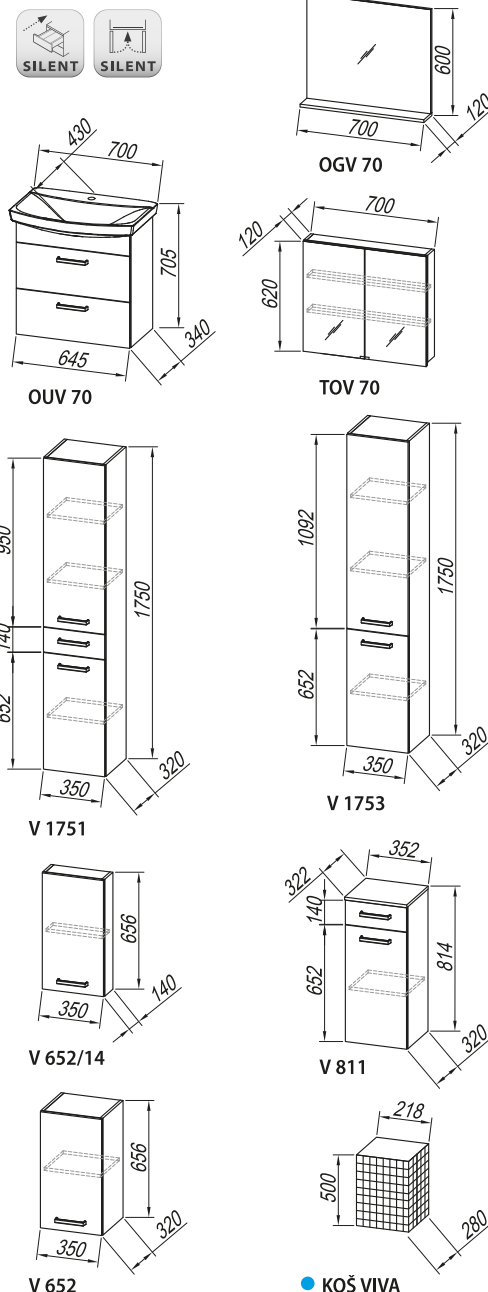

Mogućnost narudžbe namještaja u crvenoj (RED) i zelenoj (KIWI) boji.



## viva 70, 60, 50

### Fronte:

oplemenjena iverica/lakirana, bijela, kiwi, red, manhattan, beige (60% sjaj)

### Obod:

oplemenjena iverica/ bijela, sjaj

**Umivaonik:** keramički

**Ručice:** krom

**Svijetlo:**

LED 300 - 7 W

LED 45 - 3 W

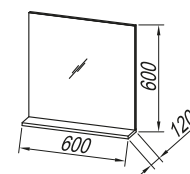

OGV 60

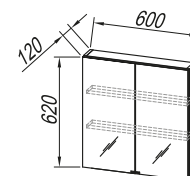

TOV 60

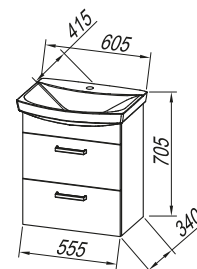

OUV 60

NAMJEŠTAJ VIVA 60 SIVO (MANH)	
Š.Vokel	Opis
	OGLEDALO S POLICOM OGV 60 SIVO (MANH)
	TOALETNI ORMARIĆ TOV 60 SIVO (MANH)
	ORMAR S UMIVAONIKOM OUV 60 SIVO (MANH)
	ORMARIĆ S VRATIMA V 652/14 SIVO (MANH)
	ORMARIĆ S VRATIMA V 652 SIVO (MANH)
	ORMARIĆ S VRATIMA I LADICOM V 811 SIVO (MANH)
	ORMARIĆ S VRATIMA I LADICOM V 1751 SIVO (MANH)
	ORMARIĆ S VRATIMA V 1753 70 SIVO (MANH)

NAMJEŠTAJ VIVA 60 BIJELO (WH)	
0406671	OGLEDALO S POLICOM OGV 60 WH BIJELO
0406618	TOALETNI ORMARIĆ TOV 60 WH BIJELO
0406620	ORMAR S UMIVAONIKOM OUV 60 WH BIJELO
0406627	ORMARIĆ S VRATIMA V 652/14 WH BIJELO
0406646	ORMARIĆ S VRATIMA V 652 WH BIJELO
	ORMARIĆ S VRATIMA I LADICOM V 811 WH BIJELO
0406619	ORMARIĆ S VRATIMA I LADICOM V 1751 WH BIJELO
	ORMARIĆ S VRATIMA V 1753 WH BIJELO

NAMJEŠTAJ VIVA 60 BEŽ (BEIGE)	
	OGLEDALO S POLICOM OGV 60 BEŽ (BEIGE)
	TOALETNI ORMARIĆ TOV 60 BEŽ (BEIGE)
	ORMAR S UMIVAONIKOM OUV 60 BEŽ (BEIGE)
0406624	ORMARIĆ S VRATIMA V 652/14 BEŽ (BEIGE)
	ORMARIĆ S VRATIMA V 652 BEŽ (BEIGE)
0406623	ORMARIĆ S VRATIMA I LADICOM V 811 BEŽ (BEIGE)
	ORMARIĆ S VRATIMA I LADICOM V 1751 BEŽ (BEIGE)
	ORMARIĆ S VRATIMA V 1753 BEŽ (BEIGE)

0406655	LED 300 SVJETILJKA BEZ UTIČNICE I PREKIDAČA ZA TOV I OGV
0406654	LED 45 SVJETILJKA BEZ UTIČNICE I PREKIDAČA ZA TOV I OGV
0406583	KOŠ ZA RUBLJE
0406567	NOGICE VIVA H= 15 cm (Par)

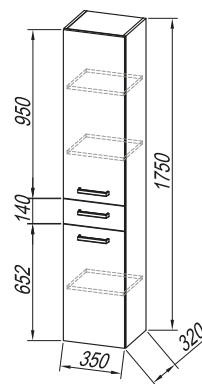

V 1751

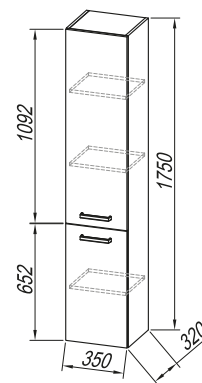

V 1753

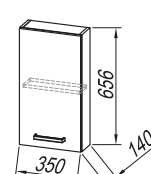

V 652/14

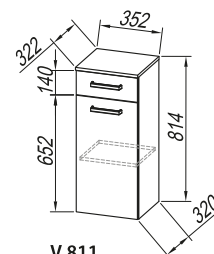

V 811

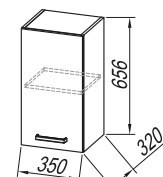

V 652

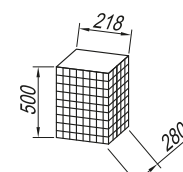

● KOŠ VIVA

Mogućnost narudžbe namještaja u crvenoj (RED) i zelenoj (KIWI) boji.



white

manhattan

red

kiwi



beige

viva 70, 60, 50

NAMJEŠTAJ VIVA 50 BEŽ (BEIGE)	
Š.Vokel	Opis
	OGLEDALO S POLICOM OGV 50 BEŽ (BEIGE)
	TOALETNI ORMARIĆ TOV 50 BEŽ (BEIGE)
0406585	ORMAR S UMIVAONIKOM OUV 50 BEŽ (BEIGE)
0406624	ORMARIĆ S VRATIMA V 652/14 BEŽ (BEIGE)
	ORMARIĆ S VRATIMA V 652 BEŽ (BEIGE)
0406623	ORMARIĆ S VRATIMA I LADICOM V 811 BEŽ (BEIGE)
	ORMARIĆ S VRATIMA I LADICOM V 1751 BEŽ (BEIGE)
	ORMARIĆ S VRATIMA V 1753 BEŽ (BEIGE)

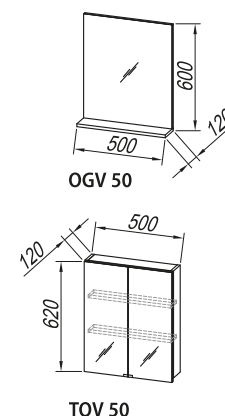
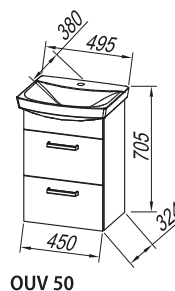

NAMJEŠTAJ VIVA 50 BIJELO (WH)	
0406582	OGLEDALO S POLICOM OGV 50 WH BIJELO
0406621	TOALETNI ORMARIĆ TOV 50 WH BIJELO
0406570	ORMAR S UMIVAONIKOM OUV 50 WH BIJELO
0406627	ORMARIĆ S VRATIMA V 652/14 WH BIJELO
0406646	ORMARIĆ S VRATIMA V 652 WH BIJELO
	ORMARIĆ S VRATIMA I LADICOM V 811 WH BIJELO
0406619	ORMARIĆ S VRATIMA I LADICOM V 1751 WH BIJELO
	ORMARIĆ S VRATIMA V 1753 WH BIJELO

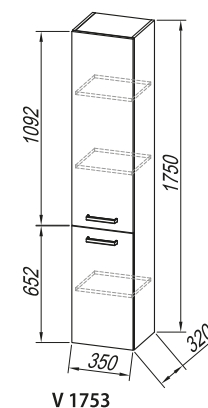
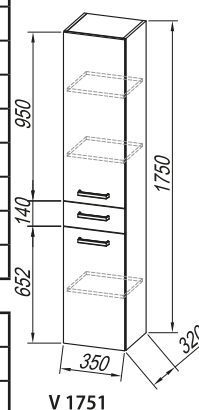

NAMJEŠTAJ VIVA 50 SIVO (MANH)	
	OGLEDALO S POLICOM OGV 50 SIVO (MANH)
	TOALETNI ORMARIĆ TOV 50 SIVO (MANH)
	ORMAR S UMIVAONIKOM OUV 50 SIVO (MANH)
	ORMARIĆ S VRATIMA V 652/14 SIVO (MANH)
	ORMARIĆ S VRATIMA V 652 SIVO (MANH)
	ORMARIĆ S VRATIMA I LADICOM V 811 SIVO (MANH)
	ORMARIĆ S VRATIMA I LADICOM V 1751 SIVO (MANH)
	ORMARIĆ S VRATIMA V 1753 70 SIVO (MANH)

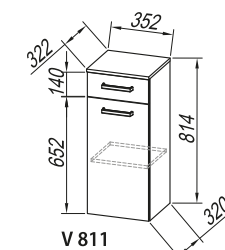
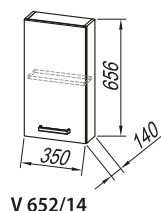

0406655	LED 300 SVJETILJKA BEZ UTIČNICE I PREKIDAČA ZA TOV I OGV
0406654	LED 45 SVJETILJKA BEZ UTIČNICE I PREKIDAČA ZA TOV I OGV
0406583	KOŠ ZA RUBLJE
0406567	NOGICE VIVA H= 15 cm (Par)

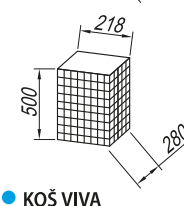
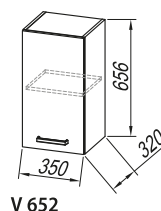

Mogućnost narudžbe namještaja u crvenoj (RED) i zelenoj (KIWI) boji.



## fiona 100, 80, 65

**Fronte:**

obložen MDF PVC folijom / bijela (visoki sjaj)

**Obod:**

oplemenjena iverica/ bijela, sjaj

**Umivaonik:** keramički

**Ručice:** krom

**Nožice:** krom

**Svijetlo:** LED, SW, S : 7W



NAMJEŠTAJ FIONA 100 BIJELO (WH)	
Š.Vokel	Opis
	OGLEDALO SA POLICOM, LED SVJETILJKOM, PREKIDAČEM I UTIČNICOM OGF 100 - LED, SW, S WH BIJELO
	ORMAR S UMIVAONIKOM OUF 100 WH BIJELO
	ORMARIĆ S VRATIMA H = 600 F 602 WH BIJELO
	ORMARIĆ S VRATIMA H = 600/600 F 602/600 WH BIJELO
	ORMARIĆ S VRATIMA I LADICOM H = 916 F 921 WH BIJELO
	ORMARIĆ S VRATIMA I LADICOM H = 1800 F 1801 WH BIJELO
	ORMARIĆ S VRATIMA H = 1800 F 1803 WH BIJELO
	ORMARIĆ S VRATIMA H = 1800/600 F 1803/600 WH BIJELO
<b>0406481</b>	KOŠ ZA RUBLJE
	NOGICE FIONA H = 105 mm (Par)



OGF 100 WH - LED, SW, S

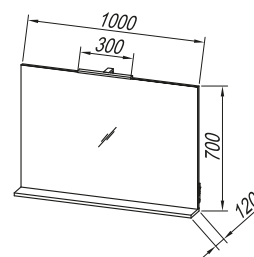

OUF 100 WH

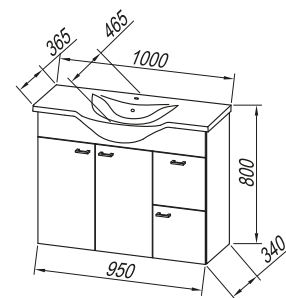

Fiona 100 WH

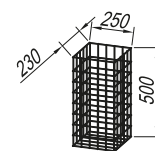
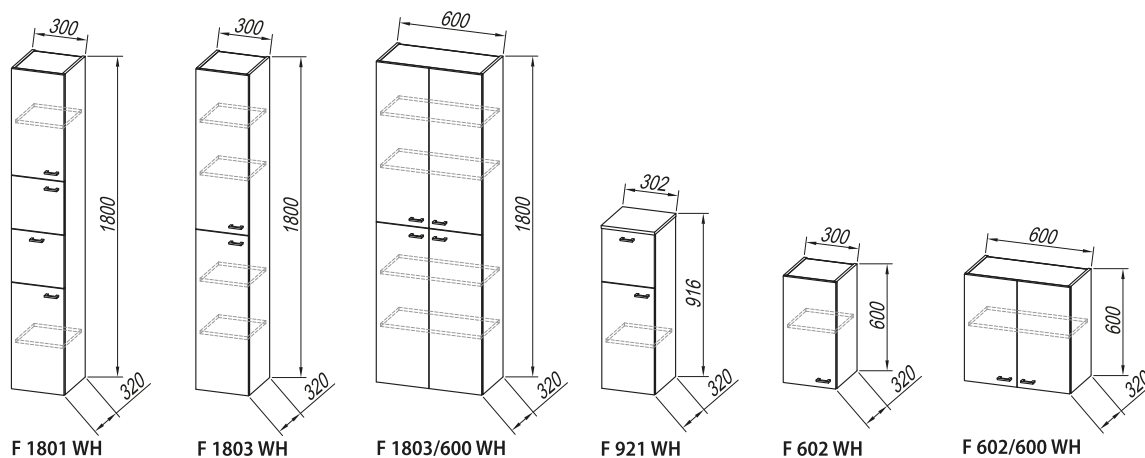

• KOŠ

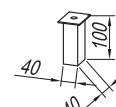

• NOGICE FIONA h= 105 mm



## fiona 100, 80, 65

- Fronte:**  
obložen MDF PVC folijom / bijela (visoki sjaj)
- Obod:**  
oplemenjena iverica/ bijela, sjaj
- Umivaonik:** keramički
- Ručice:** krom
- Nožice:** krom
- Svijetlo:** LED, SW, S : 7W

NAMJEŠTAJ FIONA 80 BIJELO (WH)	
Š.Vokel	Opis
	OGLEDALO SA POLICOM, LED SVJETILJKOM, PREKIDAČEM I UTIČNICOM OGF 80- LED, SW, S WH BIJELO
	ORMAR S UMIVAONIKOM OUF 80 WH BIJELO
	ORMARIĆ S VRATIMA H= 600 F 602 WH BIJELO
	ORMARIĆ S VRATIMA H= 600/600 F 602/600 WH BIJELO
	ORMARIĆ S VRATIMA I LADICOM H= 916 F 921 WH BIJELO
	ORMARIĆ S VRATIMA I LADICOM H= 1800 F 1801 WH BIJELO
	ORMARIĆ S VRATIMA H= 1800 F 1803 WH BIJELO
	ORMARIĆ S VRATIMA H= 1800/600 F 1803/600 WH BIJELO
<b>0406481</b>	KOŠ ZA RUBLJE
	NOGICE FIONA H= 105 mm (Par)

**A++**

OGF 80 WH - LED, SW, S

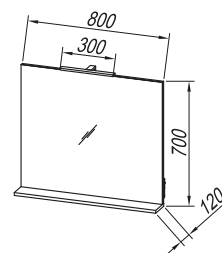

OUF 80 WH

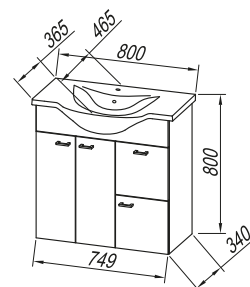

Fiona 80 WH

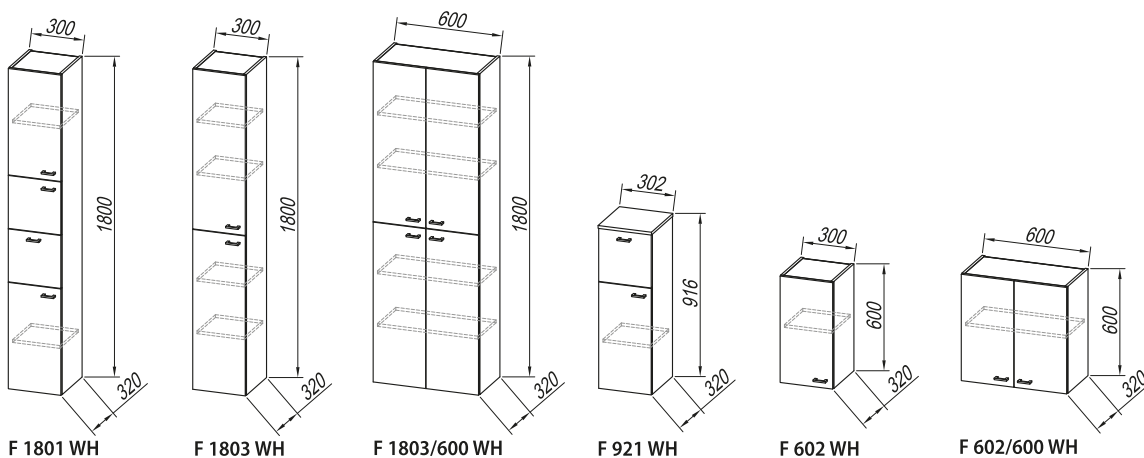

● KOŠ

● NOGICE FIONA  
h= 105 mm





## fiona 100, 80, 65

**Fronte:**

obložen MDF PVC folijom / bijela (visoki sjaj)

**Obod:**

oplemenjena iverica/ bijela, sjaj

**Umivaonik:** keramički

**Ručice:** krom

**Nožice:** krom

**Svjetlo:** LED, SW, S : 7W

NAMJEŠTAJ FIONA 65 BIJELO (WH)	
Š.Vokel	Opis
	OGLEDALO SA POLICOM, LED SVJETILJKOM, PREKIDAČEM I UTIČNICOM OGF 65- LED, SW, S WH BIJELO
	ORMAR S UMIVAONIKOM OUF 65 WH BIJELO
	ORMARIĆ S VRATIMA H= 600 F 602 WH BIJELO
	ORMARIĆ S VRATIMA H= 600/600 F 602/600 WH BIJELO
	ORMARIĆ S VRATIMA I LADICOM H= 916 F 921 WH BIJELO
	ORMARIĆ S VRATIMA I LADICOM H= 1800 F 1801 WH BIJELO
	ORMARIĆ S VRATIMA H= 1800 F 1803 WH BIJELO
	ORMARIĆ S VRATIMA H= 1800/600 F 1803/600 WH BIJELO
<b>0406481</b>	KOŠ ZA RUBLJE
	NOGICE FIONA H= 105 mm (Par)



OGF 65 WH - LED, SW, S

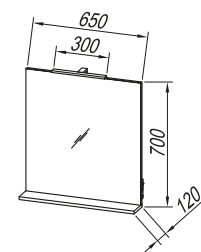

OUF 65 WH

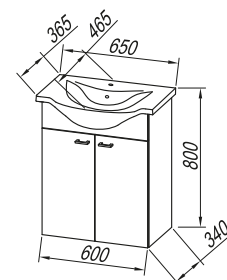

Fiona 65WH

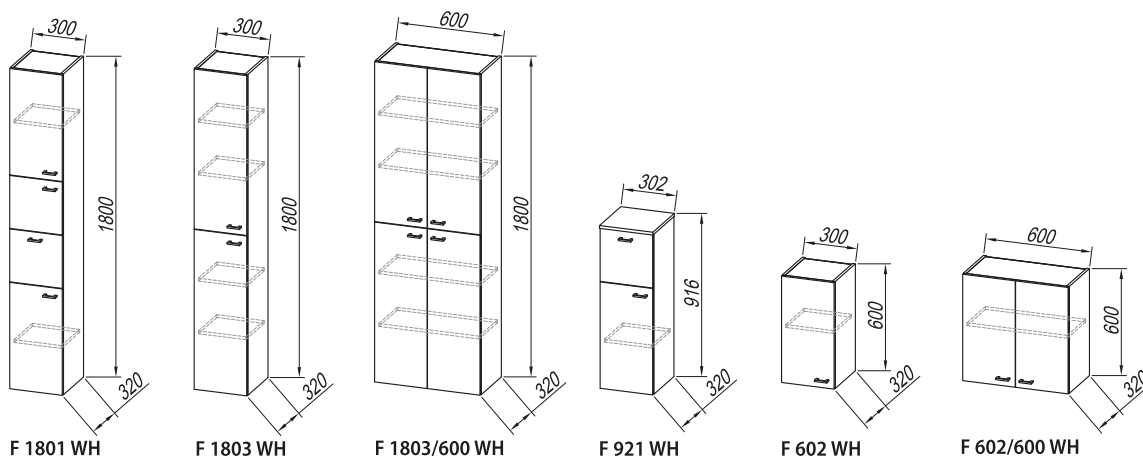

• KOŠ

• NOGICE FIONA h= 105 mm



NAMJEŠTAJ GEA 73 BIJELO (WH)	
Š.Vokel	Opis
0406360	OGLEDALO SA POLICOM, HALOGENOM SVJETILJKOM, I PREKIDAČEM OGG 73- HAL, SW WH BIJELO
0406361	ORMAR S UMIVAONIKOM OUG 73 WH BIJELO
0406384	ORMARIĆ S VRATIMA H = 600 G 602 WH BIJELO
0406385	ORMARIĆ S VRATIMA I LADICOM H = 916 G 921 WH BIJELO
0406413	ORMARIĆ S VRATIMA I LADICOM H = 1800 G 1801 WH BIJELO
0406481	KOŠ ZA RUBLJE
0406571	NOGICE GEA H = 20 cm (Par)

gea 73



**Fronte:** oplemenjena iverica – lakirana/ bijela (visoki sjaj)

**Obod:** oplemenjena iverica – bijela

**Umivaonik:** lijevani mramor

**Ručice:** krom

**Svjetlo:** halogeno - 60 W

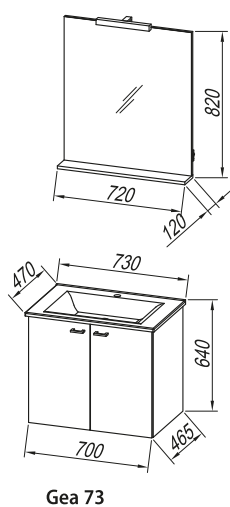

**C**  
OGG 73 WH -HAL, SW

OUG 73

Gea 73

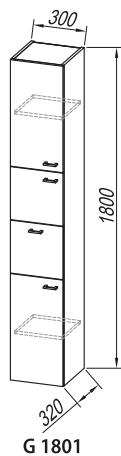

G 1801

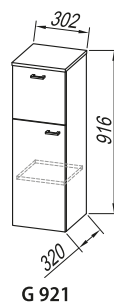

G 921

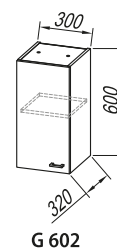

G 602

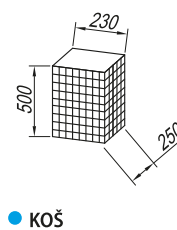

● KOŠ



NAMJEŠTAJ SARA 60 BIJELO (WH) / TEX DARK	
Š.Vokel	Opis
0406628	ORMAR S UMIVAONIKOM I OGLEDALOM SARA 62 WH BIJELO/TEX DARK
	ORMARIĆ S VRATIMA H = 600/15 S 602/15 WH BIJELO/TEX DARK
0406657	ORMARIĆ S VRATIMA H = 800/15 S 802/15 WH BIJELO/TEX DARK
0406629	ORMARIĆ S VRATIMA H = 1800 S 1803 WH BIJELO/TEX DARK
0406630	LED SVJETILJKA SARA BEZ PREKIDAČA I UTIČNICE
0406655	LED SVJETILJKA 300 BEZ PREKIDAČA I UTIČNICE
0406654	LED SVJETILJKA 45 BEZ PREKIDAČA I UTIČNICE
0406583	KOŠ ZA RUBLJE
0406571	NOGICE H = 20 cm (Par)
0406609	NOGICE H = 40 cm (Par)

NAMJEŠTAJ SARA 60 BIJELO (WH) / TEX LIGHT	
Š.Vokel	Opis
0406648	ORMAR S UMIVAONIKOM I OGLEDALOM SARA 62 WH BIJELO/TEX LIGHT
	ORMARIĆ S VRATIMA H = 600/15 S 602/15 WH BIJELO/TEX LIGHT
	ORMARIĆ S VRATIMA H = 800/15 S 802/15 WH BIJELO/TEX LIGHT
0406635	ORMARIĆ S VRATIMA H = 1800 S 1803 WH BIJELO/TEX LIGHT
0406630	LED SVJETILJKA SARA BEZ PREKIDAČA I UTIČNICE
0406655	LED SVJETILJKA 300 BEZ PREKIDAČA I UTIČNICE
0406654	LED SVJETILJKA 45 BEZ PREKIDAČA I UTIČNICE
0406583	KOŠ ZA RUBLJE
0406571	NOGICE H = 20 cm (Par)
0406609	NOGICE H = 40 cm (Par)

### sara 62

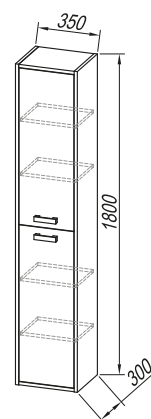

S 1803 TEX LIGHT  
S 1803 TEX DARK

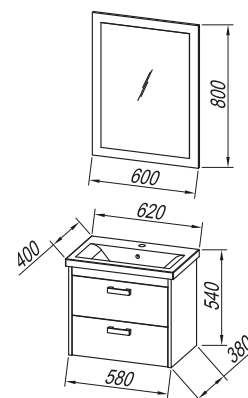

Sara 62 TEX LIGHT  
Sara 62 TEX DARK

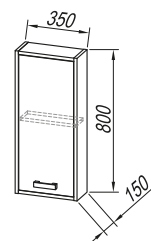

S 802/15 TEX LIGHT  
S 802/15 TEX DARK

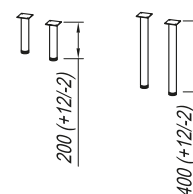

● NOGICE  
h= 200, 400 mm

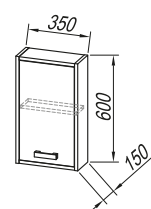

S 602/15 TEX LIGHT  
S 602/15 TEX DARK

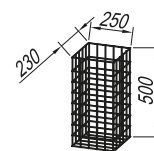

● KOŠ SARA



## sara 82



### Fronte:

oplemenjena iverica /bijela (sjaj)

**Obod:** oplemenjena iverica/  
tex. light, tex. dark

**Umivaonik:** keramički

**Ručice:** krom

**Svijetlo:**

LED SARA - 6 W

LED 300 - 7 W

LED 45 - 3 W

NAMJEŠTAJ SARA 82 BIJELO (WH) / TEX LIGHT	
Š.Vokel	Opis
0406634	ORMAR S UMIVAONIKOM I OGLEDALOM SARA 82 WH BIJELO/TEX LIGHT
	ORMARIĆ S VRATIMA H = 600/15 S 602/15 WH BIJELO/TEX LIGHT
	ORMARIĆ S VRATIMA H = 800/15 S 802/15 WH BIJELO/TEX LIGHT
0406635	ORMARIĆ S VRATIMA H = 1800 S 1803 WH BIJELO/TEX LIGHT
0406630	LED SVJETILJKA SARA BEZ PREKIDAČA I UTIČNICE
0406655	LED SVJETILJKA 300 BEZ PREKIDAČA I UTIČNICE
0406654	LED SVJETILJKA 45 BEZ PREKIDAČA I UTIČNICE
0406583	KOŠ ZA RUBLJE
0406571	NOGICE H = 20 cm (Par)
0406609	NOGICE H = 40 cm (Par)

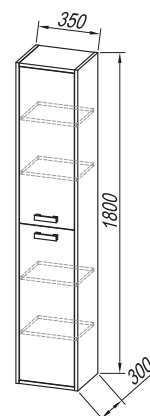

S 1803 TEX LIGHT  
S 1803 TEX DARK

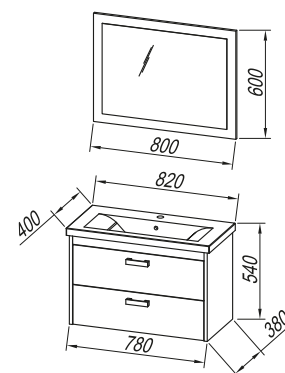

Sara 82 TEX LIGHT  
Sara 82 TEX DARK

NAMJEŠTAJ SARA 82 BIJELO (WH) / TEX DARK	
Š.Vokel	Opis
0406633	ORMAR S UMIVAONIKOM I OGLEDALOM SARA 82 WH BIJELO/TEX DARK
	ORMARIĆ S VRATIMA H = 600/15 S 602/15 WH BIJELO/TEX DARK
0406657	ORMARIĆ S VRATIMA H = 800/15 S 802/15 WH BIJELO/TEX DARK
0406629	ORMARIĆ S VRATIMA H = 1800 S 1803 WH BIJELO/TEX DARK
0406630	LED SVJETILJKA SARA BEZ PREKIDAČA I UTIČNICE
0406655	LED SVJETILJKA 300 BEZ PREKIDAČA I UTIČNICE
0406654	LED SVJETILJKA 45 BEZ PREKIDAČA I UTIČNICE
0406583	KOŠ ZA RUBLJE
0406571	NOGICE H = 20 cm (Par)
0406609	NOGICE H = 40 cm (Par)

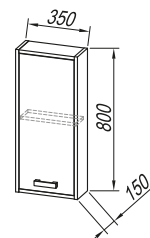

S 802/15 TEX LIGHT  
S 802/15 TEX DARK

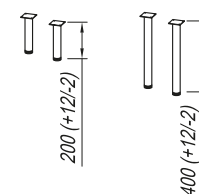

• NOGICE  
h= 200, 400 mm

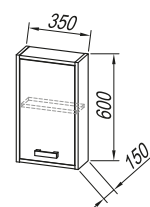

S 602/15 TEX LIGHT  
S 602/15 TEX DARK

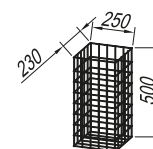

• KOŠ SARA



NAMJEŠTAJ PIXOR 76 BIJELO (WH)	
Š.Vokel	Opis
0406426	ORMAR S UMIVAONIKOM I OGLEDALOM PIXOR 76 WH BIJELO (HALOGENA SVJETILJKA S PREKIDAČEM)
0406428	ORMARIĆ S VRATIMA H = 1800 P 1802 WH BIJELO
0406429	ORMARIĆ S VRATIMA H = 1200 P 1202 WH BIJELO
0406430	ORMARIĆ S VRATIMA H = 600 P 602 WH BIJELO
0406481	KOŠ ZA RUBLJE
0406571	NOGICE H = 20 cm (Par)
0406609	NOGICE H = 40 cm (Par)

NAMJEŠTAJ PIXOR 76 BOJA ORAHA (O)	
Š.Vokel	Opis
0406431	ORMAR S UMIVAONIKOM I OGLEDALOM PIXOR 76/O BOJA ORAHA (HALOGENA SVJETILJKA S PREKIDAČEM)
0406433	ORMARIĆ S VRATIMA H = 1800 P 1802/O BOJA ORAHA
0406434	ORMARIĆ S VRATIMA H = 1200 P 1202/O BOJA ORAHA
0406435	ORMARIĆ S VRATIMA H = 600 P 602/O BOJA ORAHA
0406481	KOŠ ZA RUBLJE
0406571	NOGICE H = 20 cm (Par)
0406609	NOGICE H = 40 cm (Par)

### pixor 76 WH, 76/O, 61 WH, 61/O

**Fronte:**

oplemenjena iverična ploča, bijela (saj) / orah (saj)

**Obod:**

oplemenjena iverična ploča, bijela (saj) / orah (saj)

**Umivaonik:** keramički

**Ručice:** krom

**Svjetlo:** HAL, SW - 60 W

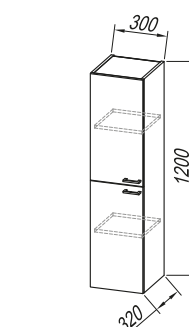
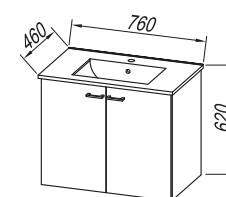
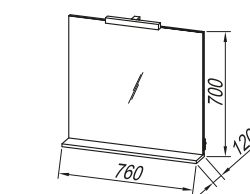

Pixor 76 WH / Pixor 76/O

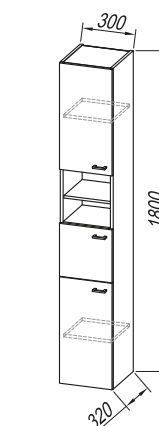

P 1802 WH / P 1802/O

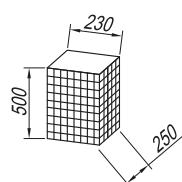

● KOŠ PIXOR

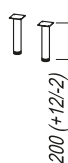

● NOGICE h= 200, 400 mm

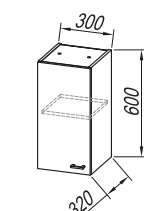
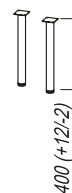

P 602 WH / P 602/O

P 1202 WH / P 1202/O





NAMJEŠTAJ PIXOR 61 BIJELO (WH)	
Š.Vokel	Opis
0406427	ORMAR S UMIVAONIKOM I OGLEDALOM PIXOR 61 WH BIJELO (HALOGENA SVJETILJKA S PREKIDAČEM)
0406428	ORMARIĆ S VRATIMA H = 1800 P 1802 WH BIJELO
0406429	ORMARIĆ S VRATIMA H = 1200 P 1202 WH BIJELO
0406430	ORMARIĆ S VRATIMA H = 600 P 602 WH BIJELO
0406481	KOŠ ZA RUBLJE
0406571	NOGICE H = 20 cm (Par)
0406609	NOGICE H = 40 cm (Par)

NAMJEŠTAJ PIXOR 61 BOJA ORAHA (O)	
Š.Vokel	Opis
0406432	ORMAR S UMIVAONIKOM I OGLEDALOM PIXOR 61/O BOJA ORAHA (HALOGENA SVJETILJKA S PREKIDAČEM)
0406433	ORMARIĆ S VRATIMA H = 1800 P 1802/O BOJA ORAHA
0406434	ORMARIĆ S VRATIMA H = 1200 P 1202/O BOJA ORAHA
0406435	ORMARIĆ S VRATIMA H = 600 P 602/O BOJA ORAHA
0406481	KOŠ ZA RUBLJE
0406571	NOGICE H = 20 cm (Par)
0406609	NOGICE H = 40 cm (Par)

### pixor 76 WH, 76/O, 61 WH, 61/O

**Fronte:**

oplemenjena iverična ploča, bijela (saj) / orah (saj)

**Obod:**

oplemenjena iverična ploča, bijela (saj) / orah (saj)

**Umivaonik:** keramički

**Ručice:** krom

**Svijetlo:** HAL, SW - 60 W

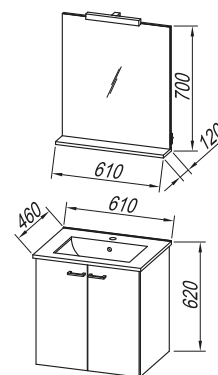

Pixor 61WH / Pixor 61/O

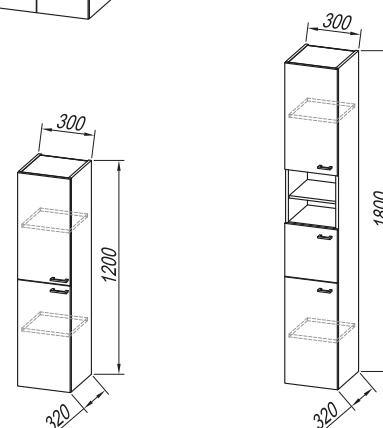

P 602 WH / P 602/O

P 1202 WH / P 1202/O

P 1802 WH / P 1802/O

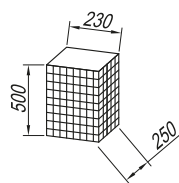

● KOŠ PIXOR

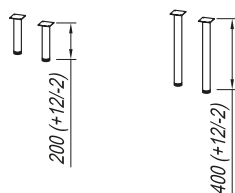

● NOGICE h= 200, 400 mm

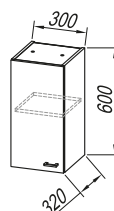



NAMJEŠTAJ PIXOR II 76 BIJELO (WH)	
Š.Vokel	Opis
0406502	ORMAR S UMIVAONIKOM I OGLEDALOM PIXOR II 76 WH BIJELO (HALOGENA SVJETILJKA S PREKIDAČEM)
0406428	ORMARIĆ S VRATIMA H = 1800 P 1802 WH BIJELO
0406429	ORMARIĆ S VRATIMA H = 1200 P 1202 WH BIJELO
0406430	ORMARIĆ S VRATIMA H = 600 P 602 WH BIJELO
0406481	KOŠ ZA RUBLJE
0406571	NOGICE H = 20 cm (Par)
0406609	NOGICE H = 40 cm (Par)

NAMJEŠTAJ PIXOR II 76 BOJA ORAHA (O)	
Š.Vokel	Opis
0406511	ORMAR S UMIVAONIKOM I OGLEDALOM PIXOR II 76/O BOJA ORAHA (HALOGENA SVJETILJKA S PREKIDAČEM)
0406433	ORMARIĆ S VRATIMA H = 1800 P 1802/O BOJA ORAHA
0406434	ORMARIĆ S VRATIMA H = 1200 P 1202/O BOJA ORAHA
0406435	ORMARIĆ S VRATIMA H = 600 P 602/O BOJA ORAHA
0406481	KOŠ ZA RUBLJE
0406571	NOGICE H = 20 cm (Par)
0406609	NOGICE H = 40 cm (Par)

### pixor II 76 WH, 76/O, 61WH, 61/O

**Fronte:**

oplemenjena iverična ploča, bijela (saj) / orah (saj)

**Obod:**

oplemenjena iverična ploča, bijela (saj) / orah (saj)

**Umivaonik:** keramički

**Ručice:** krom

**Svijetlo:** HAL, SW - 60 W

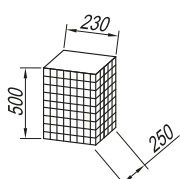
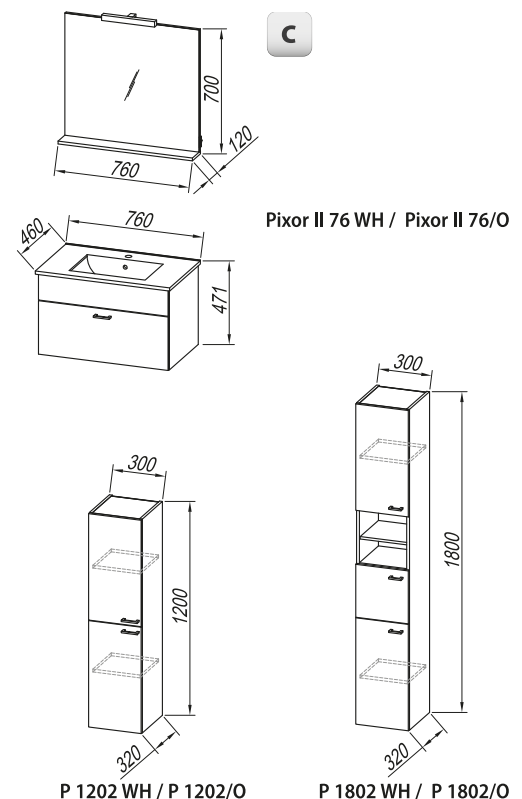

● KOŠ PIXOR

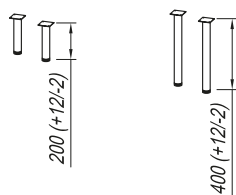

● NOGICE h= 200, 400 mm

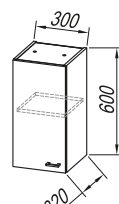

P 602 WH / P 602/O

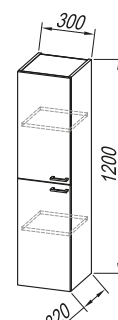

P 1202 WH / P 1202/O

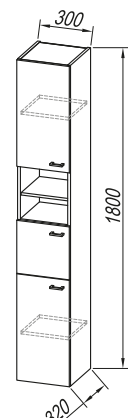

P 1802 WH / P 1802/O



NAMJEŠTAJ PIXOR II 61 BIJELO (WH)	
Š.Vokel	Opis
0406501	ORMAR S UMIVAONIKOM I OGLEDALOM PIXOR II 61 WH BIJELO (HALOGENA SVJETILJKA S PREKIDAČEM)
0406428	ORMARIĆ S VRATIMA H = 1800 P 1802 WH BIJELO
0406429	ORMARIĆ S VRATIMA H = 1200 P 1202 WH BIJELO
0406430	ORMARIĆ S VRATIMA H = 600 P 602 WH BIJELO
0406481	KOŠ ZA RUBLJE
0406571	NOGICE H = 20 cm (Par)
0406609	NOGICE H = 40 cm (Par)

NAMJEŠTAJ PIXOR II 61 BOJA ORAHA (O)	
Š.Vokel	Opis
	ORMAR S UMIVAONIKOM I OGLEDALOM PIXOR II 61/O BOJA ORAHA (HALOGENA SVJETILJKA S PREKIDAČEM)
0406433	ORMARIĆ S VRATIMA H = 1800 P 1802/O BOJA ORAHA
0406434	ORMARIĆ S VRATIMA H = 1200 P 1202/O BOJA ORAHA
0406435	ORMARIĆ S VRATIMA H = 600 P 602/O BOJA ORAHA
0406481	KOŠ ZA RUBLJE
0406571	NOGICE H = 20 cm (Par)
0406609	NOGICE H = 40 cm (Par)

### pixor II 76 WH, 76/O, 61WH, 61/O

**Fronte:**  
oplemenjena iverična ploča, bijela (sjaj) / orah (sjaj)

**Obod:**  
oplemenjena iverična ploča, bijela (sjaj) / orah (sjaj)

**Umivaonik:** keramički

**Ručice:** krom

**Svjetlo:** HAL, SW - 60 W

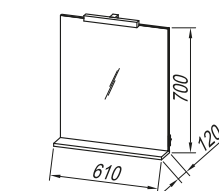

Pixor II 61 WH / Pixor II 61/OI

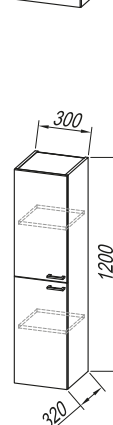

P 1202 WH / P 1202/O

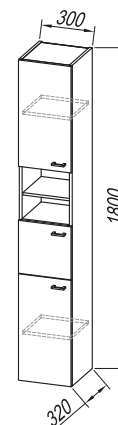

P 1802 WH / P 1802/O

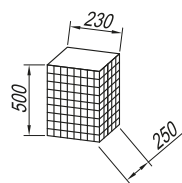

● KOŠ PIXOR

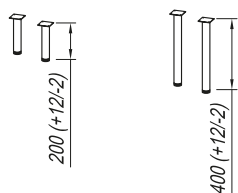

● NOGICE h= 200, 400 mm

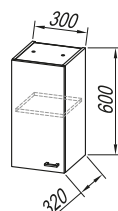

P 602 WH / P 602/O

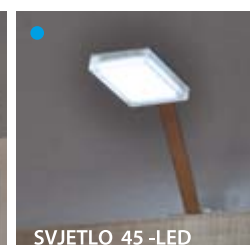
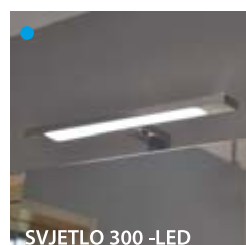

## demi 65 - L

### Fronte:

oplemenjena iverica - lakirana / bijela  
(visoki sjaj), svijetla akacija (acacia light)

**Obod:** oplemenjena iverica - lakirana / bijela  
(visoki sjaj), svijetla akacija (acacia light)

**Umivaonik:** lijevani mramor

**Ručice:** krom

### Svijetlo:

LED 300 -LED: 7 W

LED 45 -LED: 3 W

NAMJEŠTAJ DEMI 65 -L BIJELO (WH)	
Š.Vokel	Opis
	TOALETNI ORMARIĆ LIJEVA IZVEDBA TOD 65 WH BIJELO
	OGLEDALO S POLICOM OGD 35 WH BIJELO (ZA KOMBINACIJU S TOD)
	ORMARIĆ S UMIVAONIKOM LIJEVA IZVEDBA WH BIJELO
0406655	LED SVJETILJKA 300 BEZ PREKIDAČA I UTIČNICE ZA TOD
0406654	LED SVJETILJKA 45 BEZ PREKIDAČA I UTIČNICE ZA TOD

NAMJEŠTAJ DEMI 65 -L SVIJETLA AKACIJA (ACACIA LIGHT)	
Š.Vokel	Opis
0406688	TOALETNI ORMARIĆ LIJEVA IZVEDBA TOD 65 SVIJETLA AKACIJA
0406689	OGLEDALO S POLICOM OGD 35 SVIJETLA AKACIJA (ZA KOMBINACIJU S TOD)
0406687	ORMARIĆ S UMIVAONIKOM LIJEVA IZVEDBA SVIJETLA AKACIJA
0406655	LED SVJETILJKA 300 BEZ PREKIDAČA I UTIČNICE ZA TOD
0406654	LED SVJETILJKA 45 BEZ PREKIDAČA I UTIČNICE ZA TOD

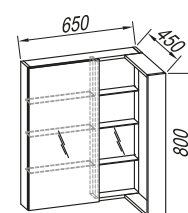

TOD 65 WH - L  
TOD 65 ACACIA LIGHT - L

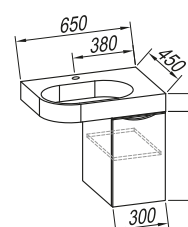

OGD 35 WH  
OGD 35 ACACIA LIGHT

OUD 65 WH - L  
OUD 65 ACACIA LIGHT - L

DEMI 65 WH - L  
DEMI 65 ACACIA LIGHT - L

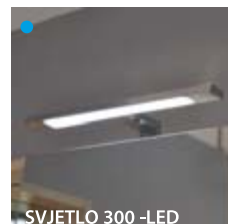

NAMJEŠTAJ DEMI 65 -D SVIJETLA AKACIJA (ACACIA LIGHT)	
Š.Vokel	Opis
	TOALETNI ORMARIĆ DESNA IZVEDBA TOD 65 SVIJETLA AKACIJA
	OGLEDALO S POLICOM OGD 35 SVIJETLA AKACIJA (ZA KOMBINACIJU S TOD)
	ORMARIĆ S UMIVAONIKOM DESNA IZVEDBA SVIJETLA AKACIJA
0406655	LED SVJETILJKA 300 BEZ PREKIDAČA I UTIČNICE ZA TOD
0406654	LED SVJETILJKA 45 BEZ PREKIDAČA I UTIČNICE ZA TOD

NAMJEŠTAJ DEMI 65 -D BIJELO (WH)	
Š.Vokel	Opis
	TOALETNI ORMARIĆ DESNA IZVEDBA TOD 65 WH BIJELO
	OGLEDALO S POLICOM OGD 35 WH BIJELO (ZA KOMBINACIJU S TOD)
	ORMARIĆ S UMIVAONIKOM DESNA IZVEDBA WH BIJELO
0406655	LED SVJETILJKA 300 BEZ PREKIDAČA I UTIČNICE ZA TOD
0406654	LED SVJETILJKA 45 BEZ PREKIDAČA I UTIČNICE ZA TOD

## demi 65 - D

### Fronte:

oplemenjena iverica - lakirana / bijela (visoki sjaj), svijetla akacija (acacia light)

**Obod:** oplemenjena iverica - lakirana / bijela (visoki sjaj), svijetla akacija (acacia light)

**Umivaonik:** lijevani mramor

**Ručice:** krom

**Svjetlo:**

LED 300 -LED: 7 W

LED 45 -LED: 3 W

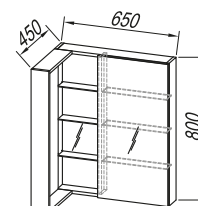

TOD 65 WH - D  
TOD 65 ACACIA LIGHT - D

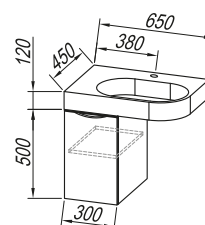

OGD 35 WH  
OGD 35 ACACIA LIGHT

OD 65 WH - D  
OD 65 ACACIA LIGHT - D

DEMI 65 WH - D  
DEMI 65 ACACIA LIGHT - D





## kiki 40

### Fronte/Obod:

oplemenjena iverica/bijela sjaj, wenge

Umivaonik: lijevani mramor

Ručice: mat

Svjetlo:

LED 300 -LED: 7 W

LED 45 -LED: 3 W

NAMJEŠTAJ KIKI 40 BIJELO (WH)	
Š.Vokel	Opis
0406509	OGLEDALO OGK 40/90 WH BIJELO
0406507	ORMARIĆ S UMIVAONIKOM OUK 40 WH BIJELO
0406655	LED SVJETILJKA 300 BEZ PREKIDAČA I UTIČNICE ZA OGK
0406654	LED SVJETILJKA 45 BEZ PREKIDAČA I UTIČNICE ZA OGK

NAMJEŠTAJ KIKI 40 WENGE	
Š.Vokel	Opis
0406515	OGLEDALO OGK 40/90 WENGE
0406516	ORMARIĆ S UMIVAONIKOM OUK 40 WENGE
0406655	LED SVJETILJKA 300 BEZ PREKIDAČA I UTIČNICE ZA OGK
0406654	LED SVJETILJKA 45 BEZ PREKIDAČA I UTIČNICE ZA OGK

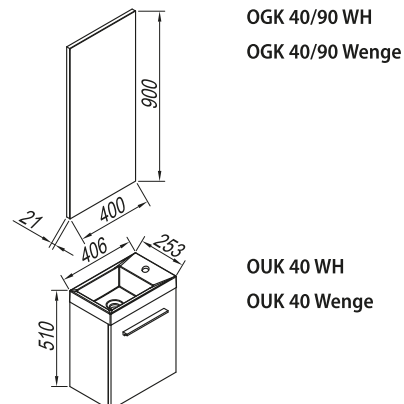

Kiki 40 / Kiki 40 Wenge



## TO 75

**Fronte:** oplemenjena iverična ploča, bijela

**Polica svjetla:** MDF/membranska folija, bijela sjaj

**Svjetlo:** E14 SW, S: HALOGEN E14 ECO 2x18W

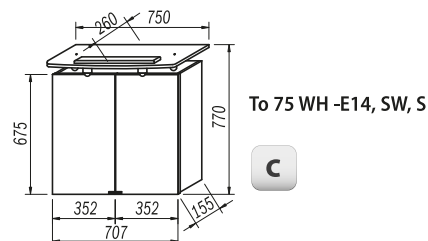

TO 75

TOALETNI ORMARIĆ TO 75	
Š.Vokel	Opis
0406226	TOALETNI ORMARIĆ S POLICAMA, SVJETILJKOM, PREKIDAČEM I UTIČNICOM TO 75 WH BIJELO



## OG 90, 120

**Ogledalo s integriranom LED žaruljom i sa satom (C), senzorski prekidač (T)**

**Svjetlo:** 3 W

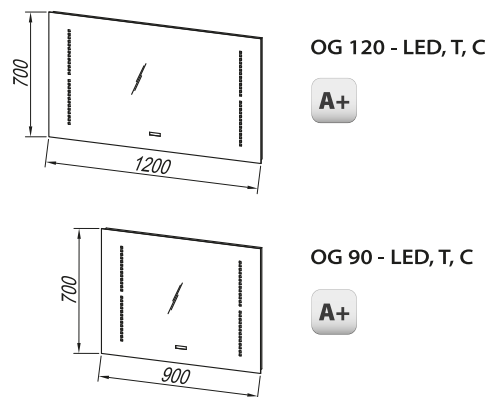

OG 90, 120

SAMOSTOJEĆA OGLEDALA S LED SVJETILJKOM OG 90, 120	
Š.Vokel	Opis
0406653	OGLEDALO S INTEGRIRANOM LED SVJETILJKOM, SATOM I SENZORSKIM PREKIDAČEM OG 90 - LED,T,C
	OGLEDALO S INTEGRIRANOM LED SVJETILJKOM, SATOM I SENZORSKIM PREKIDAČEM OG 1200 - LED,T,C



# Tuš kabine serija PRAIA







**POLUKRUŽNA TUŠ KABINA 6611 N**

Šifra Vokel

<b>BIJELI PROFIL</b>	80x80	ZAMAGLJENO STAKLO	<b>1113078</b>
		PROZIRNO STAKLO	<b>1113079</b>
	90x90	ZAMAGLJENO STAKLO	<b>1113080</b>
		PROZIRNO STAKLO	<b>1113081</b>

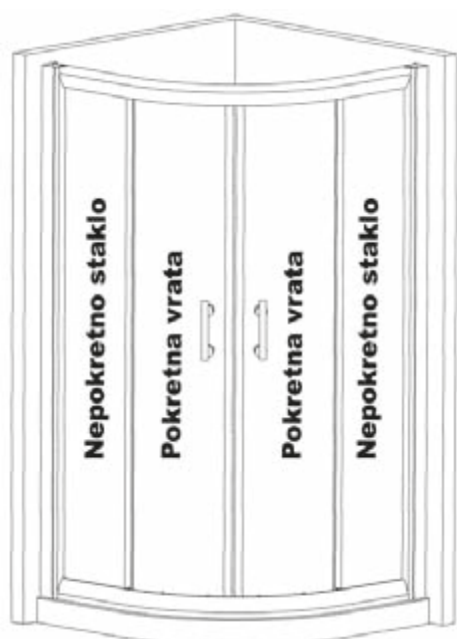
<b>SILVER PROFIL</b>	80x80	ZAMAGLJENO STAKLO	<b>1113082</b>
		PROZIRNO STAKLO	<b>1113083</b>
	90x90	ZAMAGLJENO STAKLO	<b>1113084</b>
		PROZIRNO STAKLO	<b>1113085</b>

**STAKLO ZA POLUKRUŽNU KABINU 6611 N**

Šifra Vokel

<b>POKRETNIA VRATA</b>	80x80	ZAMAGLJENO STAKLO	<b>1113094</b>
		PROZIRNO STAKLO	<b>1113064</b>
	90x90	ZAMAGLJENO STAKLO	<b>1113065</b>
		PROZIRNO STAKLO	<b>1113066</b>

<b>NEPOKRETNIA STAKLO</b>	80x80	ZAMAGLJENO STAKLO	<b>1113045</b>
		PROZIRNO STAKLO	<b>1113067</b>
	90x90	ZAMAGLJENO STAKLO	<b>1113042</b>
		PROZIRNO STAKLO	<b>1113043</b>





## KUTNA TUŠ KABINA 6671 N

			Šifra Vokel
<b>BIJELI PROFIL</b>	80x80	ZAMAGLJENO STAKLO	1113086
		PROZIRNO STAKLO	1113087
	90x90	ZAMAGLJENO STAKLO	1113088
		PROZIRNO STAKLO	1113089

<b>SILVER PROFIL</b>	80x80	ZAMAGLJENO STAKLO	1113090
		PROZIRNO STAKLO	1113091
	90x90	ZAMAGLJENO STAKLO	1113092
		PROZIRNO STAKLO	1113093

## STAKLO ZA KUTNU KABINU 6671 N

			Šifra Vokel
<b>POKRETNNA VRATA</b>	80x80	ZAMAGLJENO STAKLO	1113095
		PROZIRNO STAKLO	1113068
	90x90	ZAMAGLJENO STAKLO	1113069
		PROZIRNO STAKLO	1113096

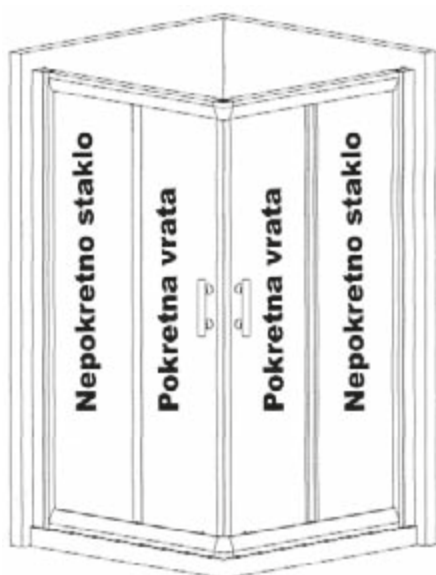

<b>NEPOKRETNNO STAKLO</b>	80x80	ZAMAGLJENO STAKLO	1113050
		PROZIRNO STAKLO	1113070
	90x90	ZAMAGLJENO STAKLO	1113047
		PROZIRNO STAKLO	1113071



<b>TUŠ VRATA - 6740</b>	
SILVER PROFIL / PROZIRNO STAKLO	
120x190	
<b>1113057</b>	



<b>TUŠ STJENKA - 6621D</b>	
SILVER PROFIL/PROZIRNO STAKLO ZA VRATA 6740 i 6742	
80x190	90x190
<b>1113058</b>	<b>1113059</b>



<b>TUŠ VRATA - 6540 - DESNA</b>	
120x190 SILK STAKLO	
SILVER PROFIL	
<b>1113060</b>	



<b>TUŠ VRATA - 6540 - LIJEVA</b>	
120x190 SILK STAKLO	
SILVER PROFIL	
<b>1113072</b>	



TUŠ STJENKA - 6621	
SILVER PROFIL / SILK STAKLO ZA VRATA 6540	
80x190	90x190
<b>1113061</b>	<b>1113062</b>



TUŠ VRATA - 6742	
140x190 PROZIRNO STAKLO	
SILVER PROFIL	
<b>1113063</b>	



#### DIHTUNG ZA TUŠ VRATA S MAGNETOM

ŠIFRA VOKEL	ŠIFRA ARTIKLA	PAKIRANJE
<b>1113074</b>	008A	1



#### DIHTUNG ZA TUŠ VRATA ZA 6611N

ŠIFRA VOKEL	ŠIFRA ARTIKLA	PAKIRANJE
<b>1113075</b>	DST90-1	1



#### DIHTUNG ZA TUŠ VRATA ZA 6671N

ŠIFRA VOKEL	ŠIFRA ARTIKLA	PAKIRANJE
<b>1113076</b>	DST90-2	1



#### VIJCI ZA MONTAŽU

ŠIFRA VOKEL	ŠIFRA ARTIKLA	PAKIRANJE
<b>1113073</b>	7111N	1



#### TOČKIĆI ZA TUŠ KABINU

ŠIFRA VOKEL	ŠIFRA ARTIKLA	PAKIRANJE
<b>1113077</b>	/	1



KYRA SAUNA 192x192x204 h



TALIA SAUNA 120x92x204 h





CUNA SAUNA 120 curva 120x127x204 h



GHIBLI HAMMAM 150x120x215 h





ETHOS HAMMAM 252x150x215 h



ETHOS HAMMAM 310x150x215 h



BOLLA Sfiro 190



BOLLA Q Sfiro 190x190



BOLLA 160



BOLLA Q Sfioro 190x190



**DREAM**  
230x230x97 h

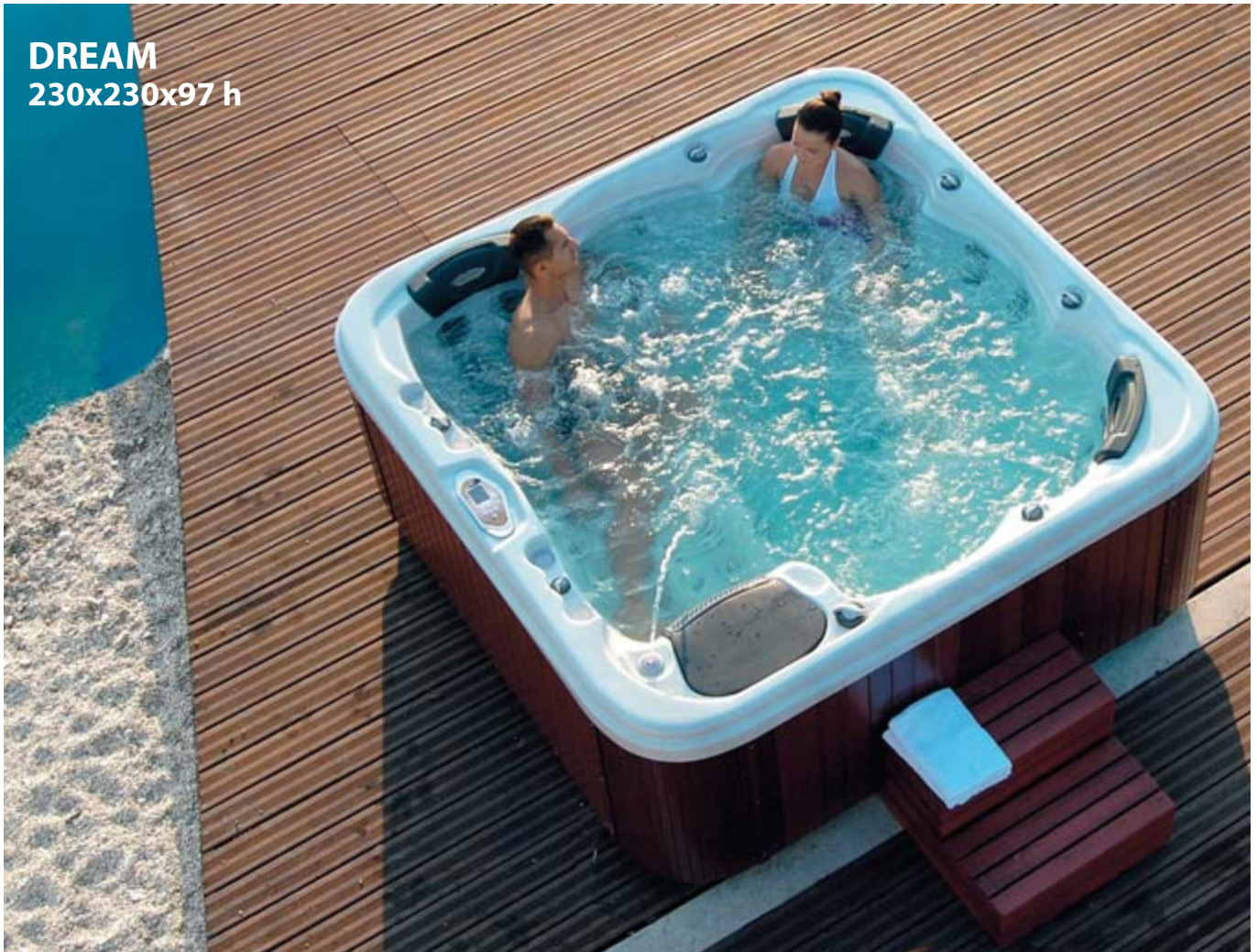

**COUNTRY**  
218x218x91 h



**AVENUE**  
200x200x91 h



**SUN**  
213x160x75 h





## LAMA ALULIFE

- UGRAĐENI NADGLAVNI TUŠ
- BOČNA TERMOSTATSKA BATERIJA
- TUŠ-KIŠNI EFEKT
- 3 FUNKCIJE HIDROMASAŽE
- POLICA

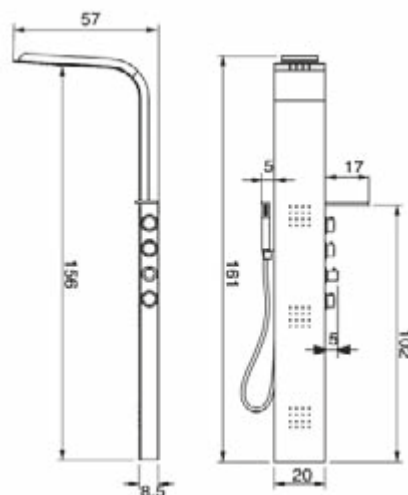

1152002	MASAŽNI STUB LAMA ALULIFE BOJA TAMNO SIVA E065 + TERMOSTATSKA BATERIJA	ART.4LAA2N0
---------	------------------------------------------------------------------------	-------------



## ETOILE 125 PLUS

- NADGLAVNI TUŠ S CROMOTERAPIJOM
- RADIO
- TERMOSTATSKA BATERIJA
- RUČNI TUŠ
- 2 HIDROMASAŽNE MLAZNICE
- 2 POLICE

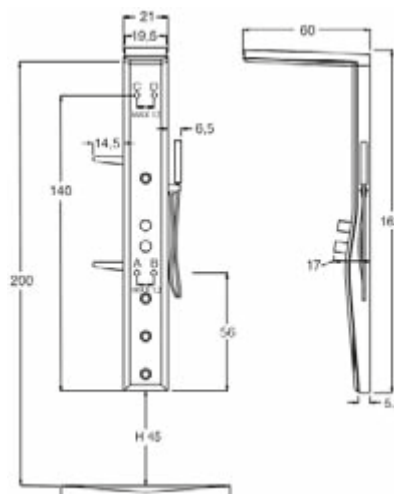

1152001	MASAŽNI STUB ETOILE 125 PLUS-BOJA ANTRACIT+TERMOSTATSKA BATERIJA + CROMOTERAPIJA + RADIO + NAPAJANJE 12V	ART.4ETA4N0
---------	----------------------------------------------------------------------------------------------------------	-------------





## SOUND IDRO JUNIOR

- KUTNA INSTALACIJA TUŠA
- TUŠ RUČICA S MAGNETOM
- 3 HIDROMASAŽNE MLAZNICE
- TUŠ KADA H= 8 cm
- KROV
- UGRAĐEN TUŠ U KROVU
- PREKLOPNO SJEDALO
- RADIO
- PARNA KUPELJ
- LCD DIGITALNI DISPLEJ

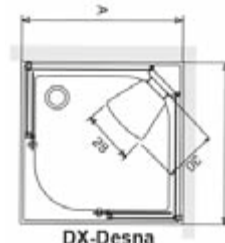
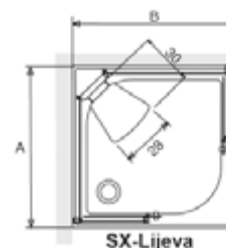
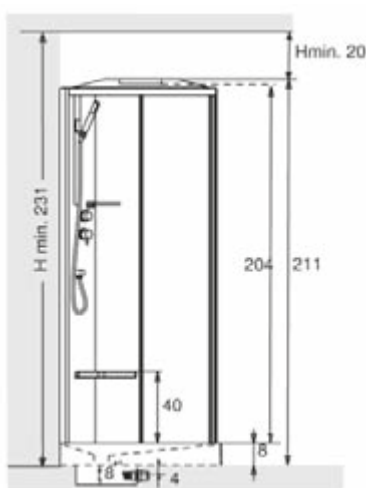

1152009	MULTIFUNKCIONALNA TUŠ KABINA SOUND IDRO 90x90 - CRNI LEĐNI PANELI	ART.1SDC2N3
---------	----------------------------------------------------------------------	-------------



## SOUND IDRO COMFORT

- KUTNA INSTALACIJA TUŠA
- TUŠ RUČICA S MAGNETOM
- 3 HIDROMASAŽNE MLAZNICE
- TUŠ KADA H= 8 cm
- KROV
- UGRAĐEN TUŠ U KROVU
- PREKLOPNO SJEDALO
- ZIDNI KRISTALNI PANELI DEBLJINE 6 mm
- KLIZNA VRATA KROMIRANE DORADE

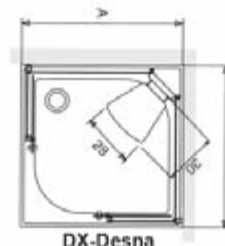
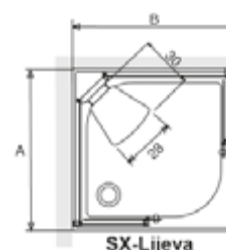
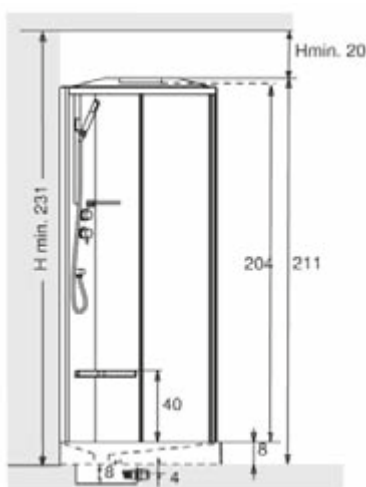

1152008	MULTIFUNKCIONALNA TUŠ KABINA SOUND PLUS 120x80 - DESNA BIJELE LEĐNI PANELI	ART.1SDC7D5
---------	-------------------------------------------------------------------------------	-------------



## TEMPO

- PARNA KUPELJ S REGULIRAJUĆOM TEMPERATUROM
- LCD DISPLEJ
- OGLEDALO
- PROGRAMSKO ODRŽAVANJE PARNOG GENERATORA
- PARNI GENERATOR S AROMATERAPIJOM I FITOTERAPIJOM
- ŠKOTSKI TUŠ
- RUČNI TUŠ NA KLIZAČU
- 6 HIDRO MLAZNICA SA 3 FUNKCIJE (RASPRŠIVAČ, PULSIRAJUĆE, KIŠNI EFEKT)
- TUŠ U KROVU SA SVJETLIMA
- POLICA
- SUSTAV ZA OTKLANJANJE KAMENCA IZ PARNOG GENERATORA
- TUŠ KADE SA SIFONOM
- SIGURNOSNO STAKLO 8 mm
- SVIJETLO
- RADIO SA IPOD KONEKCIJOM

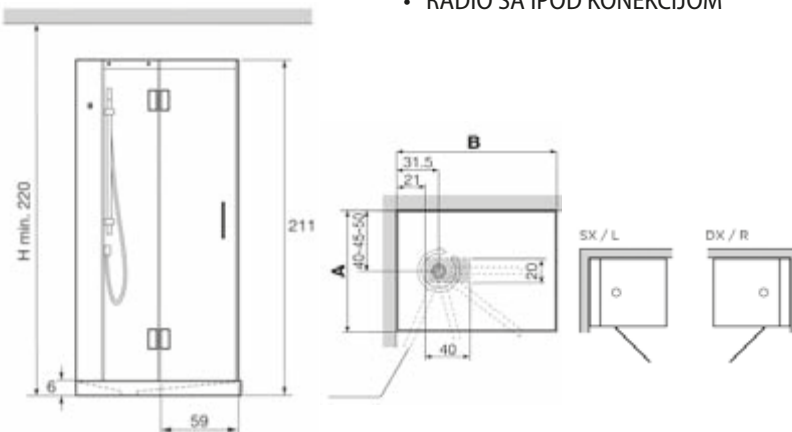

### • BOJE LEDNIH PANELA:

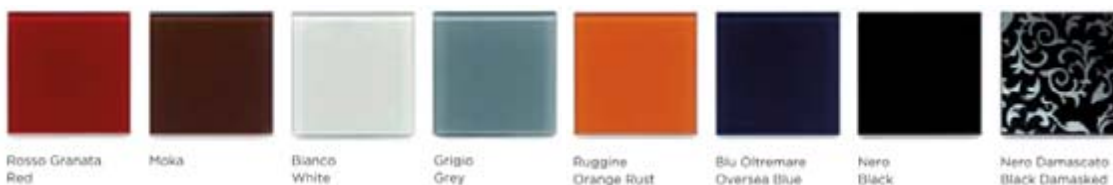

1152006	MULTIFUNKCIONALNA TUŠ KABINA TEMPO 120x80 DESNA	ART.1TPA4D3
---------	-------------------------------------------------	-------------



## ASTER T

87-92 cm

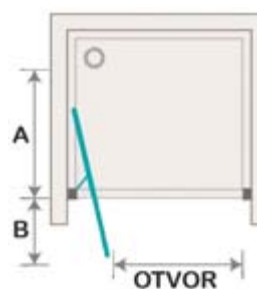

← cm →	A	B	OTVOR	ARTIKL	VERZIJA
87-92	38 cm	41-42 cm	71 cm	HSP8IRO87	Reverzibilna

1152034	TUŠ VRATA 87-92 SILVER PROZIRNO STAKLO	ART.HSP8IRO87 BR TR
---------	----------------------------------------	---------------------

## ERA plus 200x120

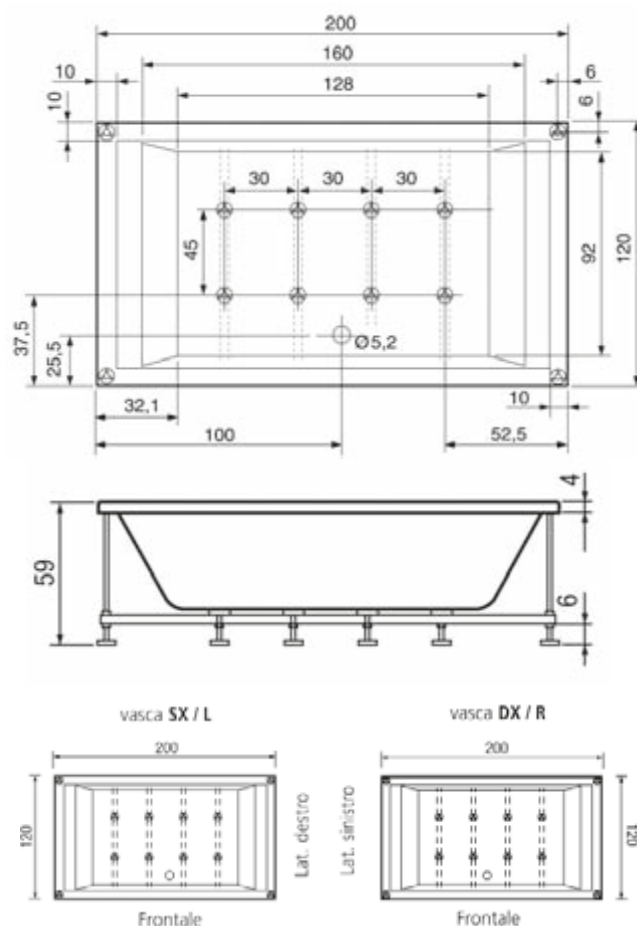

1152035	MASAŽNA KADA ERA PLUS 200x120 BIJELA BEZ OBLOGE	ART.2ERA6N6
	OBLOGA DUGA + 2 KRATKE (OLMO BROWN)	ART.0PAE4N0
	ARMATURA NA KADI	ART.0RBA9N0
	JASTUK CRNI	ART.0CUA2N0

### Opis:

- \* DIGITALNA KADA S OKVIROM
- \* VODENA + ZRAČNA MASAŽA
- \* 8 VODENIH MLAZNICA
- \* 18 ZRAČNIH MLAZNICA
- \* PULSIRAJUĆI PROGRAM
- \* MIKRO MASAŽA S PODESIVIM BRZINAMA MLAZNICA
- \* SISTEM ZA DEZINFEKCIJU
- \* ZRAČNO ČIŠĆENJE SISTEMA
- \* PODVODNO SVJETLO
- \* SENZOR NIVOVA VODE
- \* ISPUST ZA VODU
- \* SIFON



## TOP 130x80

H 200 cm - 8 mm /Aluminijski profili  
Meko magnetsko zatvaranje



1152022	TUŠ VRATA DX 128-129,5 STAKLO FUME, PROFILI BRITE TITANIO (ANTRACIT) SASTAVLJENA OD HTP7FD128STFU + HTP7PD128STFU	ART.HTP7ID128STFU
1152024	TUŠ VRATA SX 128-129,5 STAKLO FUME, PROFILI BRITE TITANIO (ANTRACIT) SASTAVLJENA OD HTP7PS128STFU + HTP7FS128STFU	ART.HTP7IS128STFU
1152023	FIKSNA STJENKA TOP 78-79,5 STAKLO FUME, PROFILI BRITE TITANIO (ANTRACIT)	ART.HTF7IR078STFU



## TOP 90x90

H 200 cm - 8 mm /Aluminijski profili  
Meko magnetsko zatvaranje



1152027	TUŠ VRATA DX 88,5-90 STAKLO PROZIRNO, PROFILI BIJELO MAT	ART.HTA1MD088BOTR
1152028	TUŠ VRATA SX 88,5-90 STAKLO PROZIRNO, PROFILI BIJELO MAT	ART.HTA1MS088BOTR





## LAMA ALULIFE

- \* UGRAĐENI NADGLAVNI TUŠ
- \* BOČNA TERMOSTATSKA BATERIJA
- \* TUŠ-KIŠNI EFEKT
- \* 3 FUNKCIJE HIDROMASAŽE
- \* POLICA

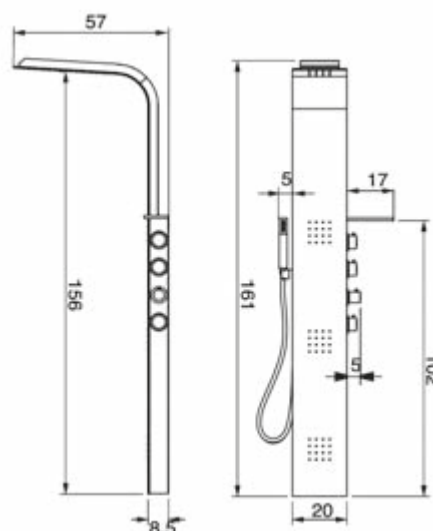

1152030	MASAŽNI STUB LAMA ALULIFE BOJA BIJELA S TERMOSTATSKOM BATERIJOM	ART.4LAA3N0
---------	--------------------------------------------------------------------	-------------

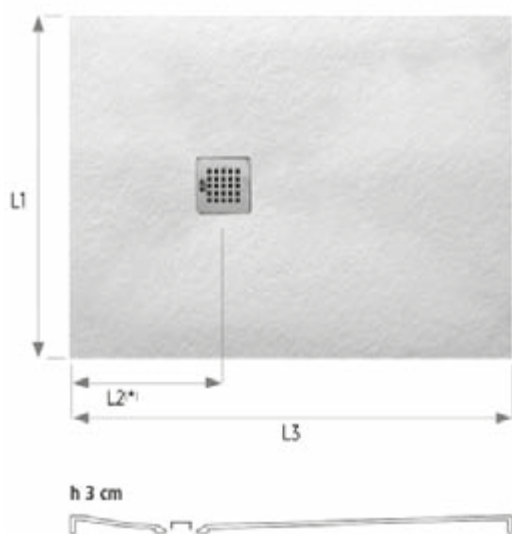

## FORMA STANDARD

H = 3 cm

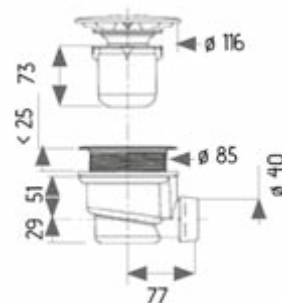

1152025	TUŠ KADA FORMA 130x80 H3 ANTRACIT SA SIFONOM	ART.5FRB5N0
1152029	TUŠ KADA FORMA 90x90 H3 BIJELO SA SIFONOM	ART.5FRB8N0





## FLOW 140x80

H 200 cm - 8 mm /Aluminijski profili  
Meko zatvaranje



1152031	TUŠ VRATA DX 138-140,5 STAKLO PROZIRNO, PROFILI SILVER SASTAVLJENA OD HFP2PD138BRTR + HFP2PD138BRTR	ART.HFP2ID138BRTR
1152032	FIKSNA STJENKA SX 78-80,5 STAKLO PROZIRNO, PROFILI SILVER	ART.HFF1IS078BRTR



## BRILL PLUS

- \* NADGLAVNI TUŠ
- \* TERMOSTATSKA BATERIJA
- \* 3 FUNKCIJE HIDROMASAŽE
- \* 2 POLICE
- \* RADIO
- \* CROMOTERAPIJA
- \* RUČNI TUŠ

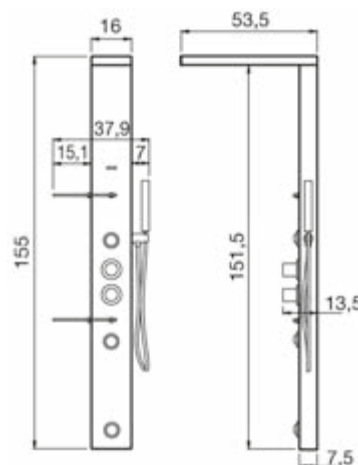

1152033	MASAŽNI STUB BRILL PLUS - PREDNJA STRANA BIJELA STAKLENA PLOČA	ART.4BIA2N0
---------	-------------------------------------------------------------------	-------------



# Masažni sistemi



TVORNICA JACUZZI IZRAĐUJE SVOJE PROIZVODE ISKLJUČIVO PO NARUDŽBI KUPACA.  
VIŠE INFORMACIJA MOŽETE POTRAŽITI NA WEB ADRESI [www.jacuzzi.it](http://www.jacuzzi.it)





PALERMO - 2180x2180x870 mm



ACAPULCO - Ø2400 mm



EVEREST - 2360x2360x970 mm



SATURN - 2300x2300x870 mm



VENUS - 2150x2150x855 mm

TVORNICA WELLIS U GRUPACIJI SA MYLINESPA IZRAĐUJE SVOJE PROIZVODE ISKLJUČIVO PO NARUDŽBI KUPACA.  
VIŠE INFORMACIJA MOŽETE POTRAŽITI NA WEB ADRESI [www.wellis.eu](http://www.wellis.eu) I [www.mylinespa.com](http://www.mylinespa.com)



DREAM 180 - 1800x800x670 mm



QUADRA 180 - 1800x800x650 mm



ASYX - 1600x900x620 mm



FUSION SPA 230 - 2300x1800x670 mm



FUSION 200 - Ø2000x670 mm



BIS ONE TOP - 2180x1660x670 mm

TVORNICA TREESSSE IZRAĐUJE SVOJE PROIZVODE ISKLJUČIVO PO NARUDŽBI KUPACA.  
VIŠE INFORMACIJA MOŽETE POTRAŽITI NA WEB ADRESI [www.gruppotres.it](http://www.gruppotres.it)





# Saune







**IR-Kabine 547 Kombi**



**Saunahaus 412 OS**



**Sauna 508 GT**



**Sauna 528 GTF**





# NAMJEŠTAJI ZA KUPAONICE.



Š. VOKEL	OPIS
<b>0462334</b>	KUPAONSKI NAMJEŠTAJ SMART 45 cm KOMPLET-BIJELO ART.20300



Š. VOKEL	OPIS
<b>0462332</b>	KUPAONSKI NAMJEŠTAJ SMART 45 cm KOMPLET-BOJA DRVETA ART.18090



Š. VOKEL	OPIS
<b>0462333</b>	KUPAONSKI NAMJEŠTAJ SMART 45 cm KOMPLET-WENGE ART.18091



Š. VOKEL	OPIS
<b>0462335</b>	KUPAONSKI NAMJEŠTAJ SMART 45 cm KOMPLET-NARANČASTA ART. 18093



Š. VOKEL	OPIS
<b>0462336</b>	KUPAONSKI NAMJEŠTAJ SMART 45 cm KOMPLET-CRVENO ART.18094



Š. VOKEL	OPIS
<b>0462337</b>	KUPAONSKI NAMJEŠTAJ SMART 45 cm KOMPLET-SIVI GRAFIT ART.20191



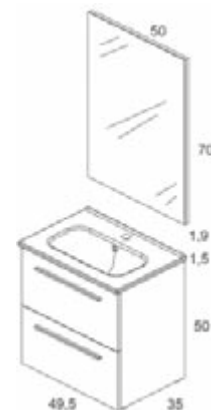

## NAMJEŠTAJ "STREET" 50 cm S LADICAMA

ŠIFRA VOKEL	OPIS	ŠIFRA ARTIKLA
0462385	KUPAONSKI NAMJEŠTAJ STREET 50 cm S DVIJE LADICE KOMPLET - BIJELO	123150

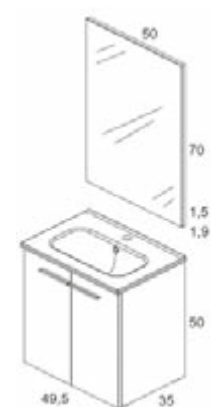

## NAMJEŠTAJ "STREET" 50 cm S VRATIMA

ŠIFRA VOKEL	OPIS	ŠIFRA ARTIKLA
0462386	KUPAONSKI NAMJEŠTAJ STREET 50 cm S VRATIMA KOMPLET - SIVO	123156





ELEGANCE 45 cm BIJELO	
Š.VOKEL	OPIS
<b>0462382</b>	KUPAONSKI NAMJEŠTAJ ELEGANCE 45 cm S JEDNIM VRATIMA - KOMPLET ART.122910



ELEGANCE 45 cm SMEĐI	
Š.VOKEL	OPIS
<b>0462383</b>	KUPAONSKI NAMJEŠTAJ ELEGANCE 45 cm S JEDNIM VRATIMA - KOMPLET ART.122911



ELEGANCE 45 cm ORAH	
Š.VOKEL	OPIS
<b>0462384</b>	KUPAONSKI NAMJEŠTAJ ELEGANCE 45 cm S JEDNIM VRATIMA - KOMPLET ART.122913





**NAMJEŠTAJ CONCEPTO**





**NAMJEŠTAJ SOUL**

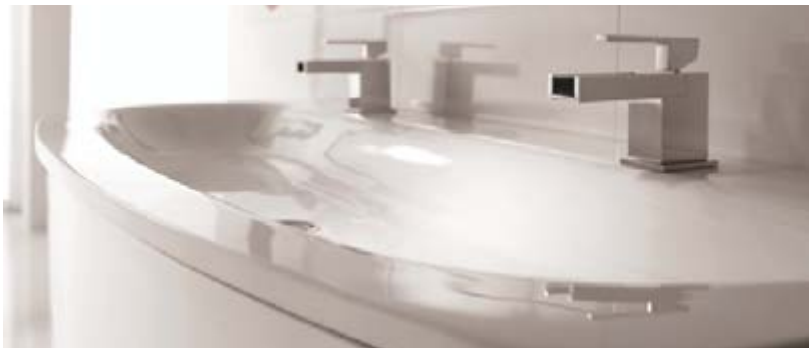





NAMJEŠTAJ EVOLUTION







# PROGETTO IDEA STELLA







THUS - BIJELA	
ŠIFRA VOKEL	OPIS
<b>0466337</b>	KOMPOZICIJA THUS 75 cm
<b>0466339</b>	ORMAR THUS DX



THUS - ROVERE	
ŠIFRA VOKEL	OPIS
<b>0466338</b>	KOMPOZICIJA THUS 75 cm
<b>0466340</b>	ORMAR THUS DX



THUS - WENGE	
ŠIFRA VOKEL	OPIS
<b>0466314</b>	KOMPOZICIJA THUS 75 cm
<b>0466341</b>	ORMAR THUS DX



THUS - BIJELA	
ŠIFRA VOKEL	OPIS
0466342	KOMPOZICIJA THUS 85 cm



THUS	
ŠIFRA VOKEL	OPIS
0466315	KOMPOZICIJA THUS 85 cm - ROVERE
0466343	KOMPOZICIJA THUS 85 cm - WENGE





THUS - BIJELA	
ŠIFRA VOKEL	OPIS
<b>0466391</b>	KOMPOZICIJA THUS 85 cm SA ORMARIĆEM PORED OGLEDALA



THUS - WENGE	
ŠIFRA VOKEL	OPIS
<b>0466317</b>	KOMPOZICIJA THUS 85 cm SA ORMARIĆEM PORED OGLEDALA

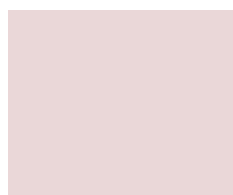

THUS - ROVERE	
ŠIFRA VOKEL	OPIS
<b>0466320</b>	KOMPOZICIJA THUS 85 cm SA ORMARIĆEM PORED OGLEDALA

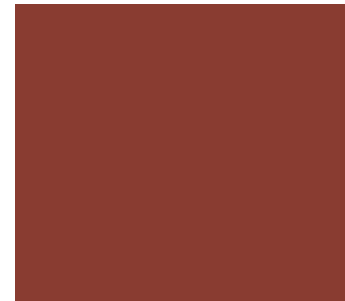
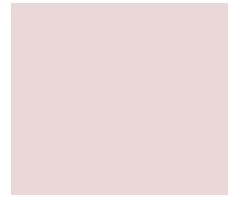

**THUS - BIJELA**

ŠIFRA VOKEL	OPIS
<b>0466390</b>	KOMPOZICIJA THUS 105 cm



**THUS - WENGE**

ŠIFRA VOKEL	OPIS
	KOMPOZICIJA THUS 105 cm



**THUS 105 cm**

ŠIFRA VOKEL	OPIS
<b>0466318</b>	KOMPOZICIJA THUS - ROVERE
<b>0466319</b>	KOMPOZICIJA THUS - WENGE



ŠIFRA VOKEL	OPIS	ŠIFRA ARTIKLA
<b>0466290</b>	OGLEDALO 95x68 cm	02295
<b>0466105</b>	SVJETILJKA	02739
<b>0466379</b>	UMIVAONIK	06199
<b>0466380</b>	ORMARIĆ ISPOD UMIVAONIKA	06203
<b>0466345</b>	ORMAR UNIKA VISEĆI BIJELO L-25 P-34 H-162	06289



UNIKA - BIJELA	
ŠIFRA VOKEL	OPIS
<b>0466344</b>	KOMPOZICIJA UNIKA 95 cm



UNIKA - LJUBIČASTA	
ŠIFRA VOKEL	OPIS
<b>0466346</b>	KOMPOZICIJA UNIKA 95 cm







ŠIFRA VOKEL	OPIS	ŠIFRA ARTIKLA
<b>0466322</b>	NAMJEŠTAJ SLIM 75/CONT. 2 VRATA-BIJELO	04693
<b>0466324</b>	NAMJEŠTAJ SLIM 75/CONT. 2 VRATA-ROVERE	04694
<b>0466323</b>	NAMJEŠTAJ SLIM 75/CONT. 2 VRATA-WENGE	04695

ŠIFRA VOKEL	OPIS	ŠIFRA ARTIKLA
<b>0466325</b>	NAMJEŠTAJ SLIM 75/V 2 VRATA-BIJELO	04679
<b>0466326</b>	NAMJEŠTAJ SLIM 75/V 2 VRATA-ROVERE	04677
<b>0466327</b>	NAMJEŠTAJ SLIM 75/V 2 VRATA-WENGE	04678

ŠIFRA VOKEL	OPIS	ŠIFRA ARTIKLA
<b>0466328</b>	NAMJEŠTAJ SLIM 75/P 2 VRATA-BIJELO	04683
<b>0466329</b>	NAMJEŠTAJ SLIM 75/P 2 VRATA-ROVERE	04681
<b>0466330</b>	NAMJEŠTAJ SLIM 75/P 2 VRATA-WENGE	04682

ŠIFRA VOKEL	OPIS	ŠIFRA ARTIKLA
<b>0466331</b>	NAMJEŠTAJ SLIM 90/P 2 VRATA-BIJELO	04691
<b>0466332</b>	NAMJEŠTAJ SLIM 90/P 2 VRATA-ROVERE	04689
<b>0466333</b>	NAMJEŠTAJ SLIM 90/P 2 VRATA-WENGE	04690





NAMJEŠTAJ EIDOS RUBIN CRVENI		
ŠIFRA VOKEL	OPIS	ŠIFRA ARTIKLA
0466236	SVJETILJKA EIDOS 245	02271
0466237	OGLEDALO EIDOS 245	02289
0466238	UMIVAONIK EIDOS 245	02309
0466248	POLICA RUBIN CRVENA	01552
0466247	ORMAR RUBIN CRVENI	02343



NAMJEŠTAJ EIDOS NARANČASTI		
ŠIFRA VOKEL	OPIS	ŠIFRA ARTIKLA
0466236	SVJETILJKA EIDOS 245	02271
0466237	OGLEDALO EIDOS 245	02289
0466238	UMIVAONIK EIDOS 245	02309
0466246	POLICA NARANČASTA 09	01552
0466245	ORMAR EIDOS NARANČASTI	02343





NAMJEŠTAJ EIDOS WENGE		
ŠIFRA VOKEL	OPIS	ŠIFRA ARTIKLA
0466236	SVJETILJKA EIDOS 245	02271
0466237	OGLEDALO EIDOS 245	02289
0466238	UMIVAONIK EIDOS 245	02309
0466240	POLICA EIDOS WENGE	02304
0466239	ORMAR EIDOS WENGE	02345

NAMJEŠTAJ EIDOS SIVO		
ŠIFRA VOKEL	OPIS	ŠIFRA ARTIKLA
0466236	SVJETILJKA EIDOS 245	02271
0466237	OGLEDALO EIDOS 245	02289
0466238	UMIVAONIK EIDOS 245	02309
0466244	POLICA EIDOS SIVO 01	01552
0466243	ORMAR EIDOS SIVO 01	02343



NAMJEŠTAJ IDEA 6 WENGE		
ŠIFRA VOKEL	OPIS	ŠIFRA ARTIKLA
0466236	SVJETILJKA	02271
0466257	OGLEDALO 47 cm	02293
0466258	UMIVAONIK TRENDY 71 cm	03021
0466259	ORMAR IDEA 70 cm WENGE	03028

NAMJEŠTAJ IDEA 7 HRAST		
ŠIFRA VOKEL	OPIS	ŠIFRA ARTIKLA
0466236	SVJETILJKA	02271
0466260	OGLEDALO 70 cm	02294
0466261	ORMARIĆ UZ OGLEDALO HRAST	03018
0466262	UMIVAONIK TRENDY 91 cm	03022
0466263	ORMAR IDEA 90 cm	03030
0466264	STAKLENA POLICA 90 cm	01572







MINY-BIJELO	
Š. VOKEL	OPIS
<b>0466348</b>	NAMJEŠTAJ MINY 85 cm VISOKI SJAJ ART.00905



MINY-WENGE	
Š. VOKEL	OPIS
	NAMJEŠTAJ MINY 85 cm



MINY-ROVERE	
Š. VOKEL	OPIS
	NAMJEŠTAJ MINY 85 cm



MINY-NARANČASTA	
Š. VOKEL	OPIS
<b>0466349</b>	NAMJEŠTAJ MINY 85 cm VISOKI SJAJ ART.00908



MINY-LILA	
Š. VOKEL	OPIS
	NAMJEŠTAJ MINY 85 cm VISOKI SJAJ



MINY-PLAVA	
Š. VOKEL	OPIS
	NAMJEŠTAJ MINY 85 cm VISOKI SJAJ



THUS-BIJELO	
Š. VOKEL	OPIS
<b>0466334</b>	NAMJEŠTAJ THUS 501V 56 cm

THUS-BIJELO	
Š. VOKEL	OPIS
<b>0466335</b>	NAMJEŠTAJ THUS 601V 65 cm

THUS-BIJELO	
Š. VOKEL	OPIS
<b>0466336</b>	NAMJEŠTAJ THUS 501C 56 cm



Š. VOKEL	OPIS	
<b>70072</b>	ORMARIĆ ISPOD UMIVAONIKA LIRA	ART.00730
<b>70073</b>	UMIVAONIK LIRA 56 cm	ART.00706
<b>70074</b>	OGLEDALO LIRA	ART.00718



Š.VOKEL	OPIS
0466296	KUPAONSKI NAMJEŠTAJ TOSCANY 85 cm (OGLEDALO ART. 01033, ORMARIĆ ART. 01035, UMIVAONIK ART. 02192 I SVJETILJKA ART. 02736)



Š.VOKEL	OPIS	
<b>70068</b>	ORMAR SKEW 75 BIJELO	ART.00414
<b>70028</b>	UMIVAONIK SKEW 75 BIJELO	ART.00388
<b>70042</b>	OGLEDALO SKEW 75 BIJELO	ART.00316
<b>70077</b>	SVJETILJKA SKEW 75 BIJELO	ART.01417



Š.VOKEL	OPIS	
<b>70080</b>	ORMAR SKEW 95 BIJELO	ART.00416
<b>70071</b>	UMIVAONIK SKEW 95 BIJELO	ART.00389
<b>70081</b>	OGLEDALO SKEW 95 BIJELO	ART.00404
<b>70082</b>	SVJETILJKA SKEW 95 BIJELO	ART.00577



Š.VOKEL	OPIS	
<b>70104</b>	ORMAR SKEW 105 BIJELO	ART.00418
<b>70079</b>	ORMARIĆ ZA OGLEDALO SKEW 105 BIJELO	ART.00410
<b>70036</b>	UMIVAONIK SKEW 105 BIJELO	ART.00390
<b>70076</b>	OGLEDALO SKEW 105 BIJELO	ART.00318
<b>70078</b>	SVJETILJKA SKEW 105 BIJELO	ART.00601



Š.VOKEL	OPIS
	<p><b>70030</b> ORMARIĆ SKEW SX LIJEVI BIJELO 190x34x25 ART.01146</p>
	<p><b>70031</b> ORMARIĆ SKEW DX DESNI BIJELO 190x34x25 ART.01148</p>

Š.VOKEL	OPIS
	<p><b>70095</b> ORMARIĆ SKEW NISKI SX LIJEVI BIJELO 109x34x25 ART.01135</p>
	<p><b>70096</b> ORMARIĆ SKEW NISKI DX DESNI BIJELO 109x34x25 ART.01138</p>



Š.VOKEL	OPIS
<b>0466287</b>	KUPAONSKI NAMJEŠTAJ MILORD 112 x 62 (ART. 03128, 03144, 03145 I 00446 x 2 KOM.)

## NAMJEŠTAJ GIORGIA 105 cm



Š.VOKEL	OPIS
<b>70155</b>	ORMAR GIORGIA 105 cm BOJA DRVETA ART.00448
<b>70036</b>	UMIVAONIK GIORGIA 105 cm ART.00390
<b>70221</b>	OGLEDALO GIORGIA DESNI SA SVJETILJKOM ART.00444



ŠIFRA VOKEL	OPIS	ŠIFRA ARTIKLA
<b>0466236</b>	SVJETILJKA EIDOS 60 W	02271
<b>0466260</b>	OGLEDALO IDEA 7 L 70 x H 68 ROVERE	02294
<b>0466297</b>	ORMAR BIJELI IDEA DX 25 x 68	03017
<b>0466298</b>	PLOČA AQUAMARIN	04489
<b>0466299</b>	ORMAR BIJELI EIDOS L 72 x H 47 x P 49	02404
<b>0466300</b>	ORMAR BIJELI S LADICAMA L 36 x H 47 x P 49	04186
<b>0466301</b>	UMIVAONIK FUORI	04101





ŠIFRA VOKEL	OPIS	ŠIFRA ARTIKLA
<b>0466236</b>	SVJETILJKA EIDOS 60 W	02271
<b>0466260</b>	OGLEDALO IDEA 7 L 70 x H 68 ROVERE	02294
<b>0466261</b>	ORMARIĆ UZ OGLEDALO HRAST 25 x 68	03018
<b>0466303</b>	PLOČA S UMIVAONIKOM NARANČASTA	04481
<b>0466263</b>	ORMAR IDEA 7 ROVERE	03030







ŠIFRA VOKEL	OPIS	ŠIFRA ARTIKLA
<b>0466236</b>	SVJETILJKA EIDOS 60 W	02271
<b>0466260</b>	OGLEDALO IDEA 7 L 70 x H 68 ROVERE	02294
<b>0466261</b>	ORMARIĆ UZ OGLEDALO HRAST 25 x 68	03018
<b>0466304</b>	PLOČA S UMIVAONIKOM AQUAMARIN	04481
<b>0466263</b>	ORMAR IDEA 7 ROVERE	03030





LIBRA 70 cm - BIJELA			
ŠIFRA VOKEL	OPIS	Š. ARTIKLA	KOM.
0466428	SVJETILJKA HALOGENA KUBO 60W QUADRA ALLUMINIO	06651	1
0466425	OGLEDALO S ORMARIĆEM 70x15x68 2/A DESNO SILVER	07690	1
0466451	ORMAR LIBRA 70 cm [ART.07703] S UMIVAONIKOM SWING 70x51 LIJEVANI MRAMOR [ART.00896]	07842	1

LIBRA 70 cm - BOJA ORAHA			
ŠIFRA VOKEL	OPIS	Š. ARTIKLA	KOM.
0466428	SVJETILJKA HALOGENA KUBO 60W QUADRA ALLUMINIO	06651	1
0466425	OGLEDALO S ORMARIĆEM 70x15x68 2/A DESNO SILVER	07690	1
0466452	ORMAR LIBRA 70 cm [ART.07704] S UMIVAONIKOM SWING 70x51 LIJEVANI MRAMOR [ART.00896]	08101	1

LIBRA 70 cm - CRNA VISOKI SJAJ			
ŠIFRA VOKEL	OPIS	Š. ARTIKLA	KOM.
0466428	SVJETILJKA HALOGENA KUBO 60W QUADRA ALLUMINIO	06651	1
0466425	OGLEDALO S ORMARIĆEM 70x15x68 2/A DESNO SILVER	07690	1
0466453	ORMAR LIBRA 70 cm [ART.07705] S UMIVAONIKOM SWING 70x51 LIJEVANI MRAMOR [ART.00896]	07843	1



LIBRA 90 cm - BIJELA			
ŠIFRA VOKEL	OPIS	Š. ARTIKLA	KOM.
0466428	SVJETILJKA HALOGENA KUBO 60W QUADRA ALLUMINIO	06651	1
0466426	OGLEDALO S ORMARIĆEM 90x15x68 2/A SILVER	07692	1
0466454	ORMAR LIBRA 90 cm [ART.07706] S UMIVAONIKOM SWING 90x51 LIJEVANI MRAMOR [ART.00897]	07844	1

LIBRA 90 cm - BOJA ORAHA			
ŠIFRA VOKEL	OPIS	Š. ARTIKLA	KOM.
0466428	SVJETILJKA HALOGENA KUBO 60W QUADRA ALLUMINIO	06651	1
0466426	OGLEDALO S ORMARIĆEM 90x15x68 2/A SILVER	07692	1
0466455	ORMAR LIBRA 90 cm [ART.07707] S UMIVAONIKOM SWING 90x51 LIJEVANI MRAMOR [ART.00897]	08102	1

LIBRA 90 cm - CRNA VISOKI SJAJ			
ŠIFRA VOKEL	OPIS	Š. ARTIKLA	KOM.
0466428	SVJETILJKA HALOGENA KUBO 60W QUADRA ALLUMINIO	06651	1
0466426	OGLEDALO S ORMARIĆEM 90x15x68 2/A SILVER	07692	1
0466456	ORMAR LIBRA 90 cm [ART.07708] S UMIVAONIKOM SWING 90x51 LIJEVANI MRAMOR [ART.00897]	07845	1



LIBRA 120 cm - BIJELA			
ŠIFRA VOKEL	OPIS	Š. ARTIKLA	KOM.
0466428	SVJETILJKA HALOGENA KUBO 60W QUADRA ALLUMINIO	06651	2
0466427	OGLEDALO S ORMARIĆEM 115x15x68 3/A SILVER	07693	1
0466457	ORMAR LIBRA 120 cm [ART.07709] S UMIVAONIKOM SWING 122 2U1 LIJEVANI MRAMOR [ART.00898]	07846	1

LIBRA 120 cm - BOJA ORAHA			
ŠIFRA VOKEL	OPIS	Š. ARTIKLA	KOM.
0466428	SVJETILJKA HALOGENA KUBO 60W QUADRA ALLUMINIO	06651	2
0466427	OGLEDALO S ORMARIĆEM 115x15x68 3/A SILVER	07693	1
0466458	ORMAR LIBRA 120 cm [ART.07710] S UMIVAONIKOM SWING 122 2U1 LIJEVANI MRAMOR [ART.00898]	08103	1

LIBRA 120 cm - CRNA VISOKI SJAJ			
ŠIFRA VOKEL	OPIS	Š. ARTIKLA	KOM.
0466428	SVJETILJKA HALOGENA KUBO 60W QUADRA ALLUMINIO	06651	2
0466427	OGLEDALO S ORMARIĆEM 115x15x68 3/A SILVER	07693	1
0466459	ORMAR LIBRA 120 cm [ART.07711] S UMIVAONIKOM SWING 122 2U1 LIJEVANI MRAMOR [ART.00898]	07847	1





LIBRA		
ŠIFRA VOKEL	OPIS	Š. ARTIKLA
0466415	<b>KUPAONSKI NAMJEŠTAJ LIBRA 60.010 60 cm BIJELO</b> [00895-UMIVAONIK 60x51 MINERALMARMO, 02293-OGLEDALO 47xH95 ALL. REVERSIBILE, 06651- SVJETILJKA HALOG KUBO 60W QUADRA, 07694-ORMARIĆ BASE LIBRA 60 2/CLASS.BIJELO]	07759
0466413	<b>KUPAONSKI NAMJEŠTAJ LIBRA 70.010 70 cm BIJELO</b> [00896-UMIVAONIK 70x51 MINERALMARMO, 02294-OGLEDALO 70xH68 ALLUMINIO, 06651- SVJETILJKA HALOG KUBO 60W QUADRA, 07703-ORMARIĆ BASE LIBRA 70 2/ CLASS.BIJELO]	07720
0466411	<b>KUPAONSKI NAMJEŠTAJ LIBRA 90.010 90 cm BIJELO</b> [00897-UMIVAONIK 90x51 MINERALMARMO, 06271-OGLEDALO 80xH68 ALLUMINIO, 06651- SVJETILJKA HALOG KUBO 60W QUADRA, 07706-ORMARIĆ BASE LIBRA 90 2/ CLASS.BIJELO]	07723
0466429	<b>KUPAONSKI NAMJEŠTAJ LIBRA 120.010 120 cm BIJELO</b> [00898-UMIVAONIK 122 MINERALMARMO, 02296-OGLEDALO 115xH68 ALLUMINIO, 06651- SVJETILJKA HALOG KUBO 60W QUADRA, 07709-ORMARIĆ BASE LIBRA 120 2/ CLASS.BIJELO]	07729



LIBRA		
ŠIFRA VOKEL	OPIS	Š. ARTIKLA
0466416	<b>KUPAONSKI NAMJEŠTAJ LIBRA 60.010 60 cm BOJA ORAHA</b> [00895-UMIVAONIK 60x51 MINERALMARMO, 02293-OGLEDALO 47xH95 ALL.REVERSIBILE, 06651- SVJETILJKA HALOG KUBO 60W QUADRA, 07695-ORMARIĆ BASE LIBRA 60 2/ CLASS.DRVO]	07760
0466414	<b>KUPAONSKI NAMJEŠTAJ LIBRA 70.010 70 cm BOJA ORAHA</b> [00896-UMIVAONIK 70x51 MINERALMARMO, 02294-OGLEDALO 70xH68 ALLUMINIO, 06651- SVJETILJKA HALOG KUBO 60W QUADRA, 07704-ORMARIĆ BASE LIBRA 70 2/ CLASS. DRVO]	07721
0466412	<b>KUPAONSKI NAMJEŠTAJ LIBRA 90.010 90 cm BOJA ORAHA</b> [00897-UMIVAONIK 90x51 MINERALMARMO, 06271-OGLEDALO 80xH68 ALLUMINIO, 06651- SVJETILJKA HALOG KUBO 60W QUADRA, 07707-ORMARIĆ BASE LIBRA 90 2/ CLASS.DRVO]	07724
0466430	<b>KUPAONSKI NAMJEŠTAJ LIBRA 120.010 120 cm BOJA ORAHA</b> [00898-UMIVAONIK 122 MINERALMARMO, 02296-OGLEDALO 115xH68 ALLUMINIO, 06651- SVJETILJKA HALOG KUBO 60W QUADRA, 07710-ORMARIĆ BASE LIBRA 120 2/ CLASS.DRVO]	07730



LIBRA		
ŠIFRA VOKEL	OPIS	Š. ARTIKLA
0466433	<b>KUPAONSKI NAMJEŠTAJ LIBRA 60.010 60cm CRNO VISOKI SJAJ</b> [00895-UMIVAONIK 60x51 MINERALMARMO, 02293-OGLEDALO 47xH95 ALL.REVERSIBILE, 06651- SVJETILJKA HALOG KUBO 60W QUADRA, 07696-ORMARIĆ BASE LIBRA 60 2/ CLASS.CRNO VISOKI SJAJ]	07761
0466432	<b>KUPAONSKI NAMJEŠTAJ LIBRA 70.010 70cm CRNO VISOKI SJAJ</b> [00896-UMIVAONIK 70x51 MINERALMARMO, 02294-OGLEDALO 70xH68 ALLUMINIO, 06651- SVJETILJKA HALOG KUBO 60W QUADRA, 07705-ORMARIĆ BASE LIBRA 70 2/ CLASS.BCRNO VISOKI SJAJ]	07722
0466431	<b>KUPAONSKI NAMJEŠTAJ LIBRA 90.010 90cm CRNO VISOKI SJAJ</b> [00897-UMIVAONIK 90x51 MINERALMARMO, 06271-OGLEDALO 80xH68 ALLUMINIO, 06651- SVJETILJKA HALOG KUBO 60W QUADRA, 07708-ORMARIĆ BASE LIBRA 90 2/ CLASS.CRNO VISOKI SJAJ]	07725
0466436	<b>KUPAONSKI NAMJEŠTAJ LIBRA 120.010 120cm CRNO VISOKI SJAJ</b> [00898-UMIVAONIK 122 MINERALMARMO, 02296-OGLEDALO 115xH68 ALLUMINIO, 06651- SVJETILJKA HALOG KUBO 60W QUADRA, 07711-ORMARIĆ BASE LIBRA 120 2/ CLASS.CRNO VISOKI SJAJ]	07731

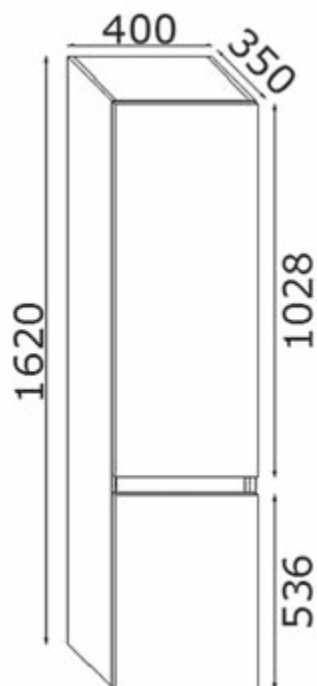

LIBRA		
ŠIFRA VOKEL	OPIS	Š. ARTIKLA
<b>0466417</b>	ORMARIĆ 40x34x162 2/A BIJELO DX	07700
<b>0466460</b>	ORMARIĆ 40x34x162 SX BIJELO	07697
<b>0466418</b>	ORMARIĆ 40x34x162 2/A DRVO BOJA ORAHA DX	07701
<b>0466461</b>	ORMARIĆ 40x34x162 SX DRVO BOJA ORAHA	07698
<b>0466434</b>	ORMARIĆ 40x34x160 DX CRNO VISOKI SJAJ	07702

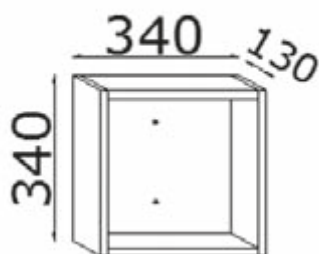

LIBRA		
ŠIFRA VOKEL	OPIS	Š. ARTIKLA
<b>0466419</b>	ORMARIĆ I-STYLE GIORNO 34x34x13 BIJELO	07168
<b>0466420</b>	ORMARIĆ I-STYLE GIORNO 34x34x13 DRVO BOJA ORAHA	07169

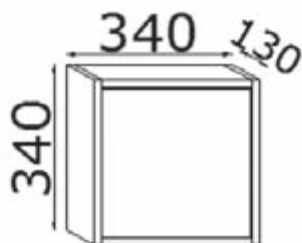

LIBRA		
ŠIFRA VOKEL	OPIS	Š. ARTIKLA
<b>0466421</b>	ORMARIĆ I-STYLE 1/ANTA 34x34x13 BIJELO SJAJ	07171
<b>0466422</b>	ORMARIĆ I-STYLE 1/ANTA 34x34x13 DRVO BOJA ORAHA	07172



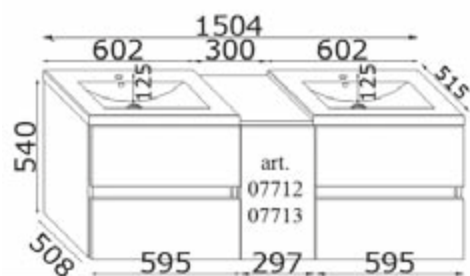

LIBRA		
ŠIFRA VOKEL	OPIS	Š. ARTIKLA
<b>0466423</b>	ORMARIĆ BASE LAT. LIBRA 30 1/A BIJELO	07712
<b>0466424</b>	ORMARIĆ BASE LAT. LIBRA 30 1/A DRVO	07713

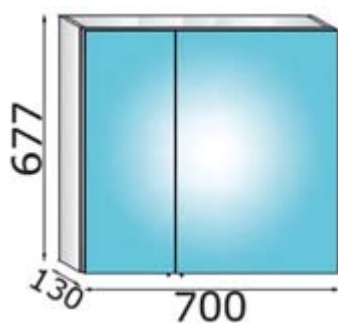

LIBRA		
ŠIFRA VOKEL	OPIS	Š. ARTIKLA
<b>0466425</b>	OGLEDALO S ORMARIĆEM 70x15x68 2/A DESNO SILVER	07690

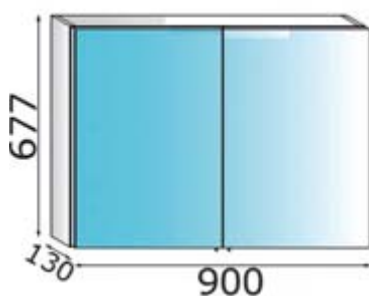

LIBRA		
ŠIFRA VOKEL	OPIS	Š. ARTIKLA
<b>0466426</b>	OGLEDALO S ORMARIĆEM 90x15x68 2/A SILVER	07692

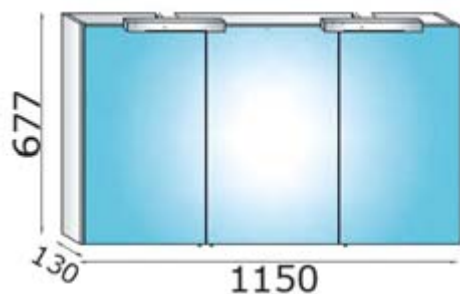

LIBRA		
ŠIFRA VOKEL	OPIS	Š. ARTIKLA
<b>0466427</b>	OGLEDALO S ORMARIĆEM 115x15x68 3/A SILVER	07693

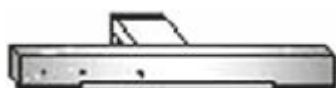

LIBRA		
ŠIFRA VOKEL	OPIS	Š. ARTIKLA
<b>0466428</b>	SVJETILJKA HALOGENA KUBO 60W QUADRA ALLUMINIO	06651



KHUADRO 61/V-1C BIJELO		
ŠIFRA VOKEL	OPIS	Š. ARTIKLA
<b>0466401</b>	00794-ORMAR, 02008-OGLEDALO, 06507-UMIVAONIK, 06651-SVJETILJKA	00986



KHUADRO 75/V-1C BIJELO		
ŠIFRA VOKEL	OPIS	Š. ARTIKLA
<b>0466402</b>	00989-ORMAR, 02008-OGLEDALO, 06508-UMIVAONIK, 06651-SVJETILJKA	00992



KHUADRO 91/V-1C BIJELO		
ŠIFRA VOKEL	OPIS	Š. ARTIKLA
<b>0466403</b>	01067-ORMAR, 06271-OGLEDALO, 06509-UMIVAONIK, 06651-SVJETILJKA	01084



GIOIA 75/P-BOJA DRVETA		
ŠIFRA VOKEL	OPIS	Š. ARTIKLA
<b>0466404</b>	01167-ORMAR, 01165-OGLEDALO, 01134-UMIVAONIK 01163-SVJETILJKA	01161



GIOIA 75/P-NOCE		
ŠIFRA VOKEL	OPIS	Š. ARTIKLA
<b>0466405</b>	01166-ORMAR, 01164-OGLEDALO, 01134-UMIVAONIK 01162-SVJETILJKA	01160



ŠIFRA VOKEL	OPIS
<b>0466464</b>	NAMJEŠTAJ MILLY 31 103cm BIJELO ART.08722 [OGLEDALO, UMIVAONIK, SVJETILJKA, ORMAR S 2 LADICE]









ŠIFRA VOKEL	OPIS
<b>0466463</b>	NAMJEŠTAJ MILLY 04 80cm BOJA ORAHA [OGLEDALO, UMIVAONIK, SVJETILJKA, ORMAR S 2 LADICE]



ŠIFRA VOKEL	OPIS
<b>0466465</b>	NAMJEŠTAJ GIUDI 60 cm BIJELO [OGLEDALO, UMIVAONIK, SVJETILJKA, ORMAR S 2 LADICE]

ŠIFRA VOKEL	OPIS
<b>0466466</b>	NAMJEŠTAJ GIUDI 80 cm BIJELO [OGLEDALO, UMIVAONIK, SVJETILJKA, ORMAR S 2 LADICE]



	<table border="1"> <tr> <td data-bbox="561 332 693 367"><b>0466236</b></td> <td data-bbox="693 332 1371 367">SVJETILJKA</td> <td data-bbox="1371 332 1486 367">ART.02271</td> </tr> </table>	<b>0466236</b>	SVJETILJKA	ART.02271															
<b>0466236</b>	SVJETILJKA	ART.02271																	
	<table border="1"> <tr> <td data-bbox="561 516 693 551"><b>0466278</b></td> <td data-bbox="693 516 1371 551">OGLEDALO 70 x 68 SA ALUMINIJSKIM RAMOM</td> <td data-bbox="1371 516 1486 551">ART.02878</td> </tr> <tr> <td data-bbox="561 551 693 585"><b>0466277</b></td> <td data-bbox="693 551 1371 585">OGLEDALO 47 x 95 SA ALUMINIJSKIM RAMOM</td> <td data-bbox="1371 551 1486 585">ART.02877</td> </tr> <tr> <td data-bbox="561 585 693 619"><b>0466279</b></td> <td data-bbox="693 585 1371 619">OGLEDALO 115 x 68 SA ALUMINIJSKIM RAMOM</td> <td data-bbox="1371 585 1486 619">ART.02880</td> </tr> </table>	<b>0466278</b>	OGLEDALO 70 x 68 SA ALUMINIJSKIM RAMOM	ART.02878	<b>0466277</b>	OGLEDALO 47 x 95 SA ALUMINIJSKIM RAMOM	ART.02877	<b>0466279</b>	OGLEDALO 115 x 68 SA ALUMINIJSKIM RAMOM	ART.02880									
<b>0466278</b>	OGLEDALO 70 x 68 SA ALUMINIJSKIM RAMOM	ART.02878																	
<b>0466277</b>	OGLEDALO 47 x 95 SA ALUMINIJSKIM RAMOM	ART.02877																	
<b>0466279</b>	OGLEDALO 115 x 68 SA ALUMINIJSKIM RAMOM	ART.02880																	
	<table border="1"> <tr> <td data-bbox="561 677 693 711"><b>0466273</b></td> <td data-bbox="693 677 1371 711">POLICA 50 x 14 BIJELA</td> <td data-bbox="1371 677 1486 711">ART.01547</td> </tr> <tr> <td data-bbox="561 711 693 746"><b>0466270</b></td> <td data-bbox="693 711 1371 746">POLICA 70 x 14 BIJELA</td> <td data-bbox="1371 711 1486 746">ART.01549</td> </tr> <tr> <td data-bbox="561 746 693 780"><b>0466271</b></td> <td data-bbox="693 746 1371 780">POLICA 95 x 14 BIJELA</td> <td data-bbox="1371 746 1486 780">ART.01551</td> </tr> <tr> <td data-bbox="561 780 693 815"><b>0466272</b></td> <td data-bbox="693 780 1371 815">POLICA 115 x 14 BIJELA</td> <td data-bbox="1371 780 1486 815">ART.01553</td> </tr> </table>	<b>0466273</b>	POLICA 50 x 14 BIJELA	ART.01547	<b>0466270</b>	POLICA 70 x 14 BIJELA	ART.01549	<b>0466271</b>	POLICA 95 x 14 BIJELA	ART.01551	<b>0466272</b>	POLICA 115 x 14 BIJELA	ART.01553						
<b>0466273</b>	POLICA 50 x 14 BIJELA	ART.01547																	
<b>0466270</b>	POLICA 70 x 14 BIJELA	ART.01549																	
<b>0466271</b>	POLICA 95 x 14 BIJELA	ART.01551																	
<b>0466272</b>	POLICA 115 x 14 BIJELA	ART.01553																	
	<table border="1"> <tr> <td data-bbox="561 860 693 895"><b>0466280</b></td> <td data-bbox="693 860 1371 895">PLOČA ZA UMIVAONIK 73 x 50 cm ROVERE</td> <td data-bbox="1371 860 1486 895">ART.02911</td> </tr> <tr> <td data-bbox="561 895 693 929"><b>0466281</b></td> <td data-bbox="693 895 1371 929">PLOČA ZA UMIVAONIK 73 x 50 cm WENGE</td> <td data-bbox="1371 895 1486 929">ART.02912</td> </tr> <tr> <td data-bbox="561 929 693 964"><b>0466285</b></td> <td data-bbox="693 929 1371 964">PLOČA ZA UMIVAONIK 98 x 50 cm ROVERE</td> <td data-bbox="1371 929 1486 964">ART.02913</td> </tr> <tr> <td data-bbox="561 964 693 998"><b>0466286</b></td> <td data-bbox="693 964 1371 998">PLOČA ZA UMIVAONIK 98 x 50 cm WENGE</td> <td data-bbox="1371 964 1486 998">ART.02914</td> </tr> <tr> <td data-bbox="561 998 693 1033"><b>0466274</b></td> <td data-bbox="693 998 1371 1033">PLOČA ZA UMIVAONIK 123 x 50 cm ROVERE</td> <td data-bbox="1371 998 1486 1033">ART.02953</td> </tr> <tr> <td data-bbox="561 1033 693 1067"><b>0466276</b></td> <td data-bbox="693 1033 1371 1067">PLOČA ZA UMIVAONIK 123 x 50 cm WENGE</td> <td data-bbox="1371 1033 1486 1067">ART.02954</td> </tr> </table>	<b>0466280</b>	PLOČA ZA UMIVAONIK 73 x 50 cm ROVERE	ART.02911	<b>0466281</b>	PLOČA ZA UMIVAONIK 73 x 50 cm WENGE	ART.02912	<b>0466285</b>	PLOČA ZA UMIVAONIK 98 x 50 cm ROVERE	ART.02913	<b>0466286</b>	PLOČA ZA UMIVAONIK 98 x 50 cm WENGE	ART.02914	<b>0466274</b>	PLOČA ZA UMIVAONIK 123 x 50 cm ROVERE	ART.02953	<b>0466276</b>	PLOČA ZA UMIVAONIK 123 x 50 cm WENGE	ART.02954
<b>0466280</b>	PLOČA ZA UMIVAONIK 73 x 50 cm ROVERE	ART.02911																	
<b>0466281</b>	PLOČA ZA UMIVAONIK 73 x 50 cm WENGE	ART.02912																	
<b>0466285</b>	PLOČA ZA UMIVAONIK 98 x 50 cm ROVERE	ART.02913																	
<b>0466286</b>	PLOČA ZA UMIVAONIK 98 x 50 cm WENGE	ART.02914																	
<b>0466274</b>	PLOČA ZA UMIVAONIK 123 x 50 cm ROVERE	ART.02953																	
<b>0466276</b>	PLOČA ZA UMIVAONIK 123 x 50 cm WENGE	ART.02954																	
	<table border="1"> <tr> <td data-bbox="561 1182 693 1216"><b>0466291</b></td> <td data-bbox="693 1182 1371 1216">PLOČA SA ALUMINIJSKIM NOGICAMA 98 cm ROVERE</td> <td data-bbox="1371 1182 1486 1216">ART.02989</td> </tr> <tr> <td data-bbox="561 1216 693 1251"><b>0466292</b></td> <td data-bbox="693 1216 1371 1251">PLOČA SA ALUMINIJSKIM NOGICAMA 98 cm WENGE</td> <td data-bbox="1371 1216 1486 1251">ART.02990</td> </tr> <tr> <td data-bbox="561 1251 693 1285"><b>0466293</b></td> <td data-bbox="693 1251 1371 1285">PLOČA SA ALUMINIJSKIM NOGICAMA 123 cm ROVERE</td> <td data-bbox="1371 1251 1486 1285">ART.02993</td> </tr> <tr> <td data-bbox="561 1285 693 1320"><b>0466294</b></td> <td data-bbox="693 1285 1371 1320">PLOČA SA ALUMINIJSKIM NOGICAMA 123 cm WENGE</td> <td data-bbox="1371 1285 1486 1320">ART.02994</td> </tr> </table>	<b>0466291</b>	PLOČA SA ALUMINIJSKIM NOGICAMA 98 cm ROVERE	ART.02989	<b>0466292</b>	PLOČA SA ALUMINIJSKIM NOGICAMA 98 cm WENGE	ART.02990	<b>0466293</b>	PLOČA SA ALUMINIJSKIM NOGICAMA 123 cm ROVERE	ART.02993	<b>0466294</b>	PLOČA SA ALUMINIJSKIM NOGICAMA 123 cm WENGE	ART.02994						
<b>0466291</b>	PLOČA SA ALUMINIJSKIM NOGICAMA 98 cm ROVERE	ART.02989																	
<b>0466292</b>	PLOČA SA ALUMINIJSKIM NOGICAMA 98 cm WENGE	ART.02990																	
<b>0466293</b>	PLOČA SA ALUMINIJSKIM NOGICAMA 123 cm ROVERE	ART.02993																	
<b>0466294</b>	PLOČA SA ALUMINIJSKIM NOGICAMA 123 cm WENGE	ART.02994																	
	<table border="1"> <tr> <td data-bbox="561 1480 693 1515"><b>0466284</b></td> <td data-bbox="693 1480 1371 1515">KONZOLA PRAVOKUTNA</td> <td data-bbox="1371 1480 1486 1515">ART.03005</td> </tr> </table>	<b>0466284</b>	KONZOLA PRAVOKUTNA	ART.03005															
<b>0466284</b>	KONZOLA PRAVOKUTNA	ART.03005																	
	<table border="1"> <tr> <td data-bbox="561 1607 693 1641"><b>0466282</b></td> <td data-bbox="693 1607 1371 1641">KONZOLA ZA PLOČU UMIVAONIKA DX</td> <td data-bbox="1371 1607 1486 1641">ART.03006</td> </tr> <tr> <td data-bbox="561 1641 693 1676"><b>0466283</b></td> <td data-bbox="693 1641 1371 1676">KONZOLA ZA PLOČU UMIVAONIKA SX</td> <td data-bbox="1371 1641 1486 1676">ART.03007</td> </tr> </table>	<b>0466282</b>	KONZOLA ZA PLOČU UMIVAONIKA DX	ART.03006	<b>0466283</b>	KONZOLA ZA PLOČU UMIVAONIKA SX	ART.03007												
<b>0466282</b>	KONZOLA ZA PLOČU UMIVAONIKA DX	ART.03006																	
<b>0466283</b>	KONZOLA ZA PLOČU UMIVAONIKA SX	ART.03007																	
	<table border="1"> <tr> <td data-bbox="561 1882 693 1917"><b>0466275</b></td> <td data-bbox="693 1882 1371 1917">ORMARIĆ SA 2 LADICE BIJELO</td> <td data-bbox="1371 1882 1486 1917">ART.02388</td> </tr> </table>	<b>0466275</b>	ORMARIĆ SA 2 LADICE BIJELO	ART.02388															
<b>0466275</b>	ORMARIĆ SA 2 LADICE BIJELO	ART.02388																	
	<table border="1"> <tr> <td data-bbox="561 2077 693 2112"><b>0466295</b></td> <td data-bbox="693 2077 1371 2112">ALUMINIJSKA NOGICA 25 cm</td> <td data-bbox="1371 2077 1486 2112">ART.03054</td> </tr> </table>	<b>0466295</b>	ALUMINIJSKA NOGICA 25 cm	ART.03054															
<b>0466295</b>	ALUMINIJSKA NOGICA 25 cm	ART.03054																	



Š.VOKEL	OPIS
<b>0466306</b>	OGLEDALO DX BIJELO SP/405 L = 67 H = 68 D = 16 ART.01050 DESNO



Š.VOKEL	OPIS
<b>0466308</b>	OGLEDALO BIJELO SP/406 L = 90 H = 68 D = 16 ART.01054



Š.VOKEL	OPIS
<b>0466469</b>	OGLEDALO DX BIJELO SP/401 L = 70 cm ART.00218 DESNO



Š.VOKEL	OPIS
<b>0466468</b>	OGLEDALO BIJELO SP/402 L = 90 cm ART.00220

PROGETTO IDEA STELLA



	<p><b>1107046</b></p>	<p>KUPAONSKI ORMAR IVANA 60-190</p>
	<p><b>1107047</b></p>	<p>KUPAONSKI ORMAR IVANA 60-130</p>
	<p><b>1107048</b></p>	<p>KUPAONSKI ORMAR IVANA 40-190</p>
	<p><b>1107050</b></p>	<p>KUPAONSKI ORMAR IVANA 40-130</p>



KUPAONSKI NAMJEŠTAJ - SET 55 cm	
<b>1107066</b>	OGLEDALO OLIMPIA 55
<b>05781</b>	UGRADBENI UMIVAONIK NASADNI 55 cm
<b>1107058</b>	KUPAONSKA BAZA RINO 55 cm

KUPAONSKI NAMJEŠTAJ - SET 65 cm	
<b>1107067</b>	OGLEDALO OLIMPIA 65 cm
<b>0449158</b>	UGRADBENI UMIVAONIK NASADNI 65 cm
<b>1107059</b>	KUPAONSKA BAZA RINO 65 cm

KUPAONSKI NAMJEŠTAJ - SET 75 cm	
<b>1107068</b>	OGLEDALO OLIMPIA 75
<b>05779</b>	UGRADBENI UMIVAONIK NASADNI 75 cm
<b>1107060</b>	KUPAONSKA BAZA RINO 75 cm

KUPAONSKI NAMJEŠTAJ - SET 85 cm	
<b>1107069</b>	OGLEDALO OLIMPIA 85
<b>05780</b>	UGRADBENI UMIVAONIK NASADNI 85 cm
<b>1107061</b>	KUPAONSKA BAZA RINO 85 cm SA 3 VRATA



RINO -SET KUPAONSKI NAMJEŠTAJ

KUPAONSKI NAMJEŠTAJ - SET 55 cm	
<b>1107084</b>	OGLEDALO RINO 55 NEW HALOGENA LAMPA
<b>05781</b>	UGRADBENI UMIVAONIK NASADNI 55 cm
<b>1107058</b>	KUPAONSKA BAZA RINO 55 cm

KUPAONSKI NAMJEŠTAJ - SET 65 cm	
<b>1107081</b>	OGLEDALO RINO 65 NEW HALOGENA LAMPA
<b>0449158</b>	UGRADBENI UMIVAONIK NASADNI 65 cm
<b>1107059</b>	KUPAONSKA BAZA RINO 65 cm

KUPAONSKI NAMJEŠTAJ - SET 75 cm	
<b>1107082</b>	OGLEDALO RINO 75 NEW HALOGENA LAMPA
<b>05779</b>	UGRADBENI UMIVAONIK NASADNI 75 cm
<b>1107060</b>	KUPAONSKA BAZA RINO 75 cm

KUPAONSKI NAMJEŠTAJ - SET 85 cm	
<b>1107083</b>	OGLEDALO RINO 85 NEW HALOGENA LAMPA
<b>05780</b>	UGRADBENI UMIVAONIK NASADNI 85 cm
<b>1107061</b>	KUPAONSKA BAZA RINO 85 cm SA 3 VRATA



# gala





# gala



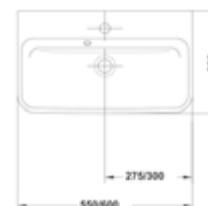
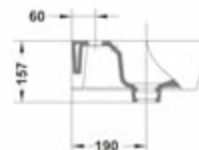

Šifra Vokel	Opis	Š. Artikla
<b>1162001</b>	UMIVAONIK EMMA SQUARE S MONTAŽNIM PRIBOROM 60x35	2701501

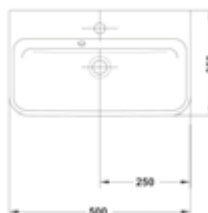
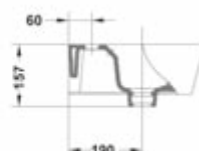
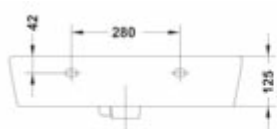

Šifra Vokel	Opis	Š. Artikla
<b>1162002</b>	UMIVAONIK EMMA SQUARE S MONTAŽNIM PRIBOROM 50x35	2708001

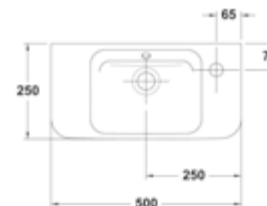
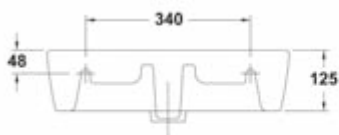

Šifra Vokel	Opis	Š. Artikla
<b>1162003</b>	UMIVAONIK EMMA SQUARE S MONTAŽNIM PRIBOROM 50x25	2709501

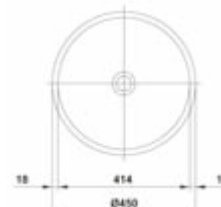
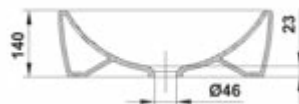

Šifra Vokel	Opis	Š. Artikla
<b>1162004</b>	UMIVAONIK URBAN Ø45 BEZ RUPE ZA BATERIJU	1304001

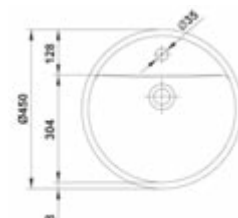
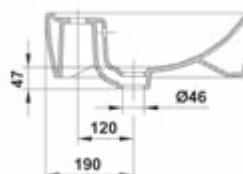

Šifra Vokel	Opis	Š. Artikla
<b>1162005</b>	UMIVAONIK URBAN Ø45 S RUPOM ZA BATERIJU	1303001

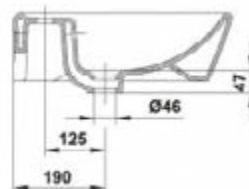
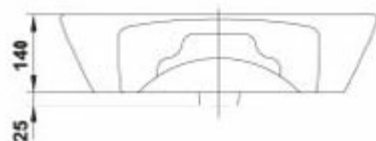

Šifra Vokel	Opis	Š. Artikla
1162006	UMIVAONIK SOFT 57,5x45 BEZ RUPE ZA BATERIJU	1305001

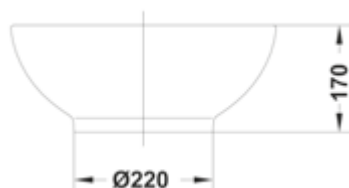

Šifra Vokel	Opis	Š. Artikla
1162007	UMIVAONIK BOWL Ø41 BEZ RUPE ZA BATERIJU	1004101





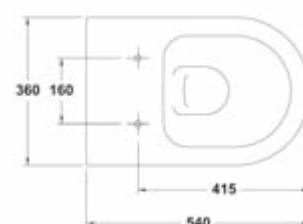
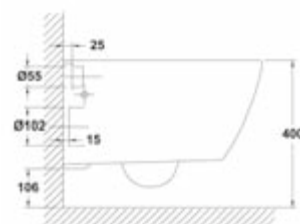
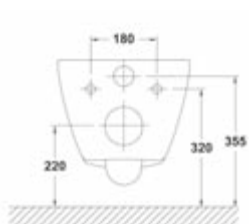

Šifra Vokel	Opis	Š. Artikla
1162010	VIŠEĆA WC ŠKOLJKA EMMA 54x36 cm	3017201
1162008	SPOROSPUŠTAJUĆA WC DASKA EMMA	5166101

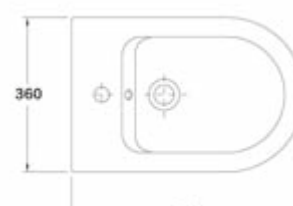
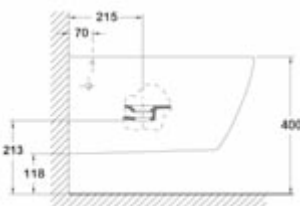
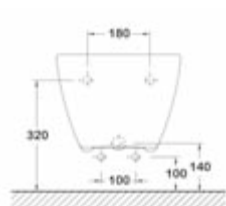

Šifra Vokel	Opis	Š. Artikla
1162009	VIŠEĆI BIDE EMMA 54x36 cm	3036201



	<b>1111013</b>	UMIVAONIK UGRADNI	55x44 cm	ART.ECB33551
	<b>1111001</b>	UMIVAONIK UGRADNI	65x44 cm	ART.ECB33651
	<b>1111002</b>	UMIVAONIK UGRADNI	75x48 cm	ART.ECB33751
	<b>1111003</b>	UMIVAONIK UGRADNI	85x48 cm	ART.ECB33851
	<b>1111004</b>	UMIVAONIK UGRADNI	95x50 cm	ART.ECB33951
	<b>1111011</b>	UMIVAONIK OKRUGLI	42x42x18 cm	ART.EAB1405
	<b>1111012</b>	UMIVAONIK PRAVOKUTNI	48x38x16.5 cm	ART.EAB2301

	<b>1111008</b>	UMIVAONIK KVADRATNI	46x46x14 cm	ART.ECB27461
	<b>1111005</b>	UMIVAONIK PRAVOKUTNI	60x48x14 cm	ART.ECB25601
	<b>1111006</b>	UMIVAONIK PRAVOKUTNI	80x48x14 cm	ART.ECB25801
	<b>1111007</b>	UMIVAONIK PRAVOKUTNI	100x48x14 cm	ART.ECB25A01
	<b>1111009</b>	UMIVAONIK KVADRATNI	40x40x10 cm	ART.EAB3046
	<b>1111010</b>	UMIVAONIK OKRUGLI	39x39x17.5 cm	ART.EAB1715
	<b>1111015</b>	UMIVAONIK OKRUGLI	39x39x15 cm	ART.EAB1111
	<b>1111014</b>	UMIVAONIK OKRUGLI	39x39x15 cm	ART.EAB1115

QUARTZ / SMOLA  
 DIMENZIJA : 307x141 cm  
 DEBLJINA : 1,2 - 2 - 3 cm



TREVI



CASTELLO



CONDOTTI



NAVONA



BASALTINA



BIANCHISSIMO



LAPIS



NERO SENATORE



GRIS CENIZA



BEIGE ARENA



ALABASTRO



NEGRO LUCIENTE



MARON LUCIENTE



BLANCO LUCIENTE



MARON GLACE



IMPERIAL BLACK



BLANCO SAL



BEIGE SAL



NEW RUBINO



NERO POMPEI



MARRON TORBA



TORTORA



GRIS SERENA



GRIS ANTRACITA



CREMA CHIARA



BLANCO PALOMA



BLANCO CAMELIA



ROMAN BLACK



BLANCO SARAIBA



NEW DIAMANTE



MRAMOR/ SMOLA  
DIMENZIJA : 305x124 cm  
DEBLJINA : 2 - 3 cm



NAPOLEON BROWN



NERO PORTORO



PERLINO ROSATO



RASOTICA



VERDE TIRRENO



GRIGIO CARNICO



FIOR DI PESCO



CALACATTA



ROSSO ASIAGO



PERLATO APPIA



BOTTICINO



BRECCIA AURORA



BLANCO SAL



CONDOTTI



NAPOLEON BROWN



RASCOTICA

MRAMOR/ SMOLA  
 DIMENZIJA : 305x124 cm  
 DEBLJINA : 2 - 3 cm



GRIGIO LAVAGNA



GRIGIO FONTANE



BELGIAN NIGHT



DUCCIO



GIORGIONE



TIZIANO



NERO LAVA



GRAY DOCKS



NEW GRIGIO AURELIO



CANALETTO



CIMABUE



BIANCO TITANO



AIDA WHITE



BIANCO CARRARA



DONATELLO



GIOTTO



SABBIA



BEIGE MARFIL



BIANCO AMBRA



MADREPERLA



SOLE



RIGEL



POLARE



GIALLO MAYA



RIGOLETTO BEIGE



RIGOLETTO BROWN



WHITE ICEBERG



TIZIANO

	<b>1115001</b>	OGLEDALO KRISTAL 563 x 686 mm ART.1
	<b>1115002</b>	OGLEDALO KRISTAL 560 x 685 mm ART.2
	<b>1115003</b>	OGLEDALO KRISTAL 450 x 450 mm ART.5
	<b>1115004</b>	OGLEDALO KRISTAL 460 x 860 mm ART.8
	<b>1115005</b>	OGLEDALO KRISTAL 400 x 600 mm ART.11
	<b>1115007</b>	OGLEDALO KRISTAL FAZETIRANO 550 x 750 mm



Vokel

INKER  
zoom









# INKER zoom

Praktičan, suvremen i konkurentan dizajn. To predlaže Zoom, kupaonski brend osmišljen da ponudi korisna, fleksibilna, globalna rješenja. Zoom udovoljava najosnovnijim, univerzalnim zahtjevima tržišta: ne odričući se modernog dizajna, on potvrđuje da funkcionalnost leži u jednostavnosti.

Zoom to postiže pomoću integralnih, raznolikih i funkcionalnih prijedloga.

Serije koje čine brend Zoom imaju širok raspon proizvoda i njihove linije slijede najmoderniji dizajn. Zoom ne krči nove puteve, nego ga definira neutralna osobnost koja proklamira temeljne vrijednosti: bez sumnje, to je način da se pobjegne od pritisaka koje nameće tržište, braneći jednostavnost.

Zoom predstavlja napredne, ekološke, funkcionalne proizvode koji su opremljeni uređajima i automatskim mehanizmima za uštedu vode i energije.

Zoom, brend koji zagovara funkcionalnost u kupaonskom prostoru.





## JULIA

Profinjene, minimalističke linije. Čisti, jednostavni oblici. To je serija Julia, idealna za tradicionalnije prostore. Njezin se stil stapa sa svim dekorativnim zamislama.

**INKER**  
**zoom**



ŠIFRA VOKEL	UMIVAONIK		
<b>05517</b>	<b>810JU1Z001001</b>	Umivaonik 65 cm	3-275
<b>05142</b>	<b>810JU2Z001001</b>	Umivaonik 60 cm	3-272
<b>05006</b>	<b>810JU3Z001001</b>	Umivaonik 56 cm	3-271
<b>05008</b>	<b>810JU4Z001001</b>	Umivaonik 51 cm	3-270
<b>05104</b>	<b>815JU1Z001001</b>	Umivaonik 45 cm	3-276
<b>05019</b>	<b>819JU1Z000001</b>	Stalak	3-277

ŠIFRA VOKEL	WC MONOBLOK	
<b>05496</b>	<b>821JU6Z0000F1</b> WC monoblok odvod u zid.	3-330
<b>05740</b>	<b>821JU7Z0000F1</b> WC monoblok odvod u pod.	3-332
<b>05525</b>	<b>828JU2Z00LRF1</b> Vodokotlić.	3-215

A	B	C	D	E	F
650	510	180	220	285	200
600	495	180	210	285	200
560	475	180	210	285	200
510	445	180	200	285	200
450	360	155	165	205	170

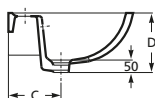
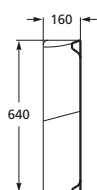
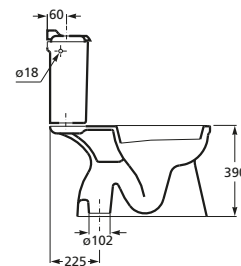
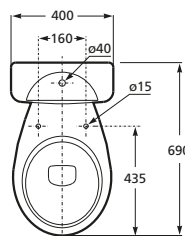
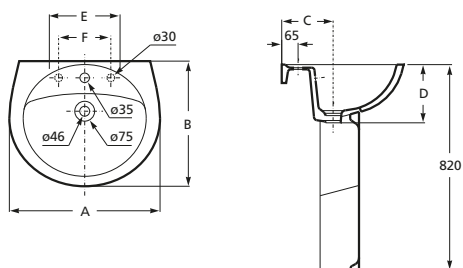
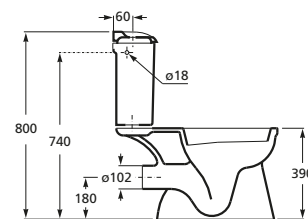
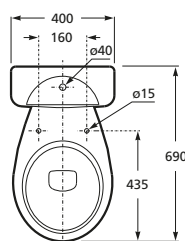



ŠIFRA VOKEL	WC STOJEĆA	
<b>05105</b>	<b>822JU6Z0000F1</b> WC stojeća školjka odvod u zid.	3-383
<b>05013</b>	<b>822JU7Z0000F1</b> WC stojeća školjka odvod u pod.	3-273

ŠIFRA VOKEL	SET WC MONOBLOK	
<b>0449161</b>	<b>821JU6Z00LDF1</b> Set WC monoblok odvod u zid vodokotlić, mehanizam, WC daska, pribor za montažu.	
<b>0449162</b>	<b>821JU7Z00LDF1</b> Set WC monoblok odvod u pod vodokotlić, mehanizam, WC daska, pribor za montažu.	
<b>0449163</b>	<b>82DJU2Z000001</b> WC daska duroplast antibakterijska.	

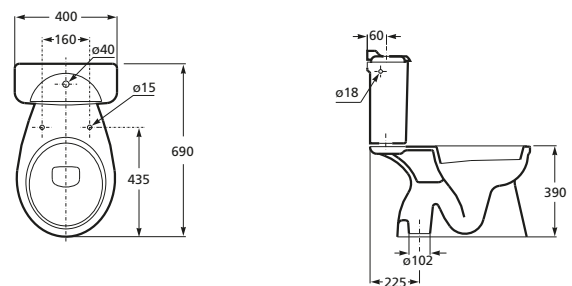
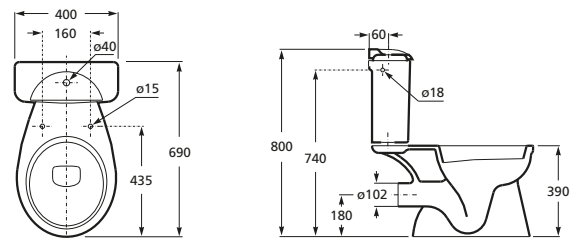
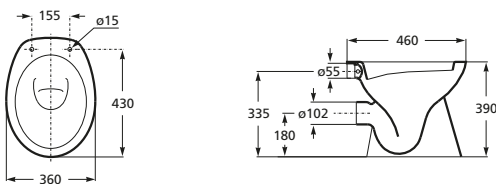
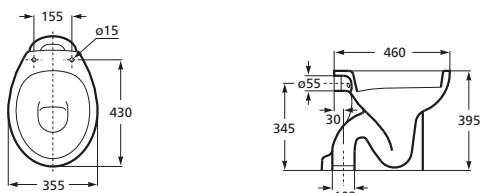

ŠIFRA VOKEL	STOJEĆI BIDE	
<b>05085</b>	<b>832JU1Z0010F1</b> Stojeći bide.	3-279

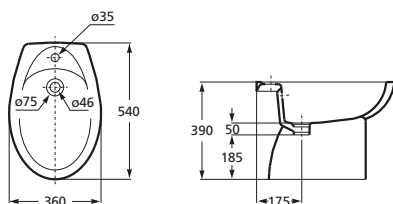





ŠIFRA VOKEL	UMIVAONIK		
<b>05517</b>	<b>810JU1Z001001</b>	65 cm	3-275
<b>05142</b>	<b>810JU2Z001001</b>	60 cm	3-272
<b>05006</b>	<b>810JU3Z001001</b>	55 cm	3-271
<b>05008</b>	<b>810JU4Z001001</b>	51 cm	3-270
<b>05104</b>	<b>815JU1Z001001</b>	45 cm	3-276
<b>05686</b>	<b>819JU2Z0000F1</b> Maska-Polustalak.		3-277

ŠIFRA VOKEL	WC VISEĆI	
<b>05439</b>	<b>820JU1Z000001</b> WC Viseći.	3-219

A	B	C	D	E	F
650	510	180	220	285	200
600	495	180	210	285	200
560	475	180	210	285	200
510	445	180	200	285	200
450	360	155	165	205	170

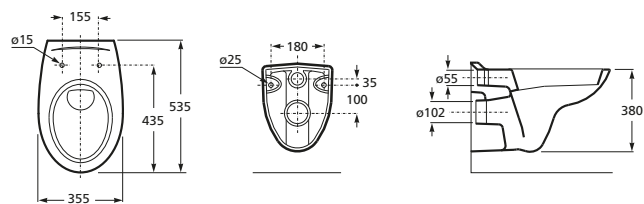
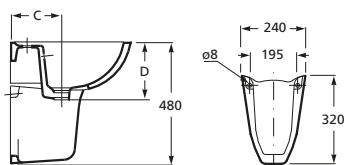
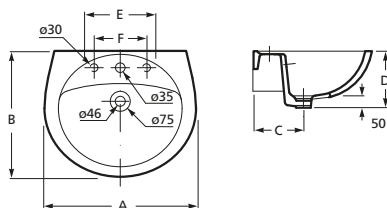



ŠIFRA  
VOKEL

SKRAĆENA VISEĆA WC

**0449157**

**820JU2Z000001**  
Skraćena viseća WC.

3-220

ŠIFRA  
VOKEL

VISEĆI BIDE

**05425**

**830JU1Z001001**  
Viseći Bide.

3-221

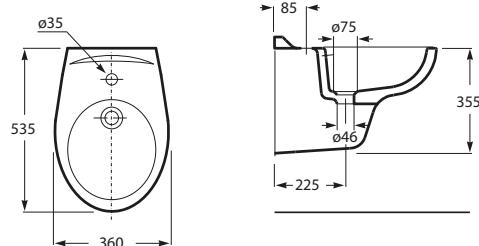
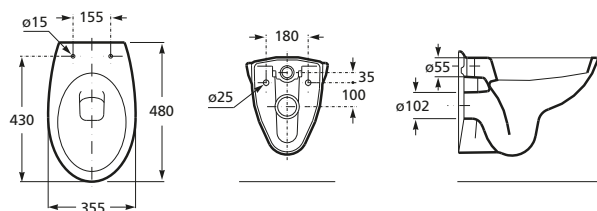



# Sara

Sanitarna serija



**INKER**  
**zoom**



<b>ŠIFRA VOKEK</b>	<b>WC ŠKOLJKA SARA</b>
<b>05729</b>	WC školjka "Sara" podna, bijelo Klasa "A" 3-703

<b>ŠIFRA VOKEK</b>	<b>WC ŠKOLJKA SARA</b>
<b>05734</b>	WC školjka "Sara" baltik, bijelo Klasa "A" 3-704

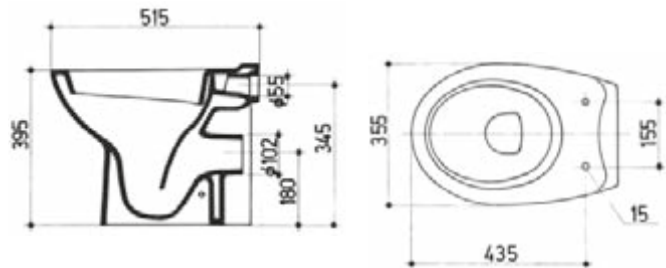
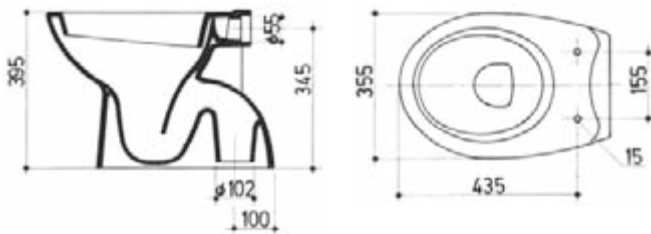

<b>ŠIFRA VOKEK</b>	<b>WC ŠKOLJKA SARA</b>
<b>05742</b>	WC školjka "Sara" viseća, bijelo Klasa "A" 3-719

<b>ŠIFRA VOKEK</b>	<b>BIDE SARA</b>
<b>05743</b>	Bide "Sara" viseći, bijelo Klasa "A" 3-721

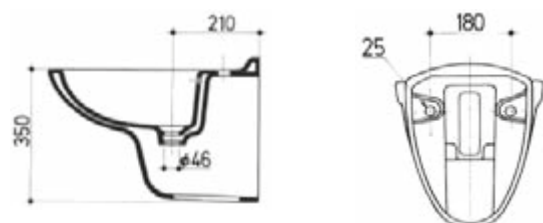
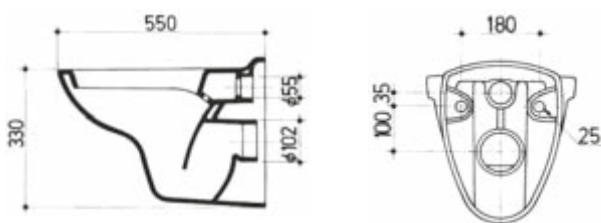



<b>ŠIFRA VOKEL</b>	<b>WC ŠKOLJKA SARA</b>	
<b>05764</b>	<b>WC ŠKOLJKA SARA MONOBLOK</b> Bijelo, odvod u zid.	3-714
<b>05765</b>	<b>VODOKOTLIČ SARA MONOBLOK</b> Bijelo.	3-715

<b>ŠIFRA VOKEL</b>	<b>UMIVAONIK SARA</b>	
<b>05723</b>	<b>UMIVAONIK SARA 830 mm</b> Bijelo, klasa "A".	3-735
<b>05736</b>	<b>UMIVAONIK SARA 580 mm</b> Bijelo, klasa "A".	3-702

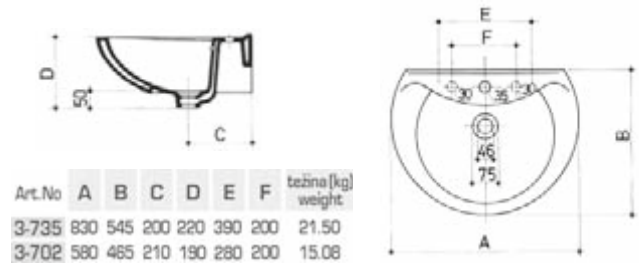
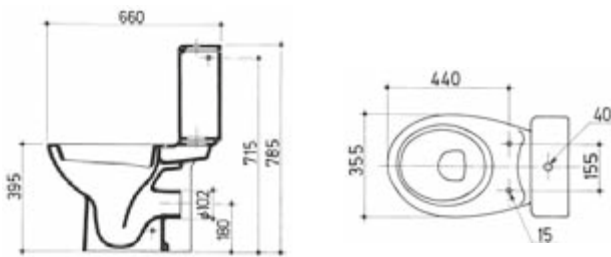

<b>ŠIFRA VOKEL</b>	<b>BIDE SARA</b>	
<b>05730</b>	Bijelo, klasa "A"	3-720

<b>ŠIFRA VOKEL</b>	<b>MASKA SARA</b>	
<b>05735</b>	Bijelo, klasa "A"	3-739

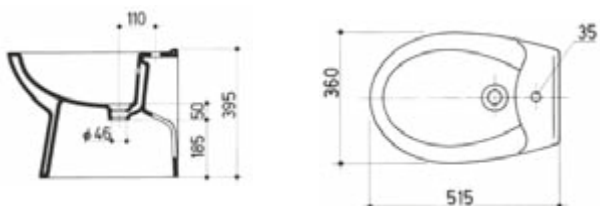





## VALENTINA

Otkrijte svoju klasičnu stranu pomoću dizajna serije Valentina. Njezine tradicionalne linije daju kupaonici dašak različitosti i glamura.

**INKER**  
**zoom**





ŠIFRA VOKEL	UMIVAONIK		
<b>05035</b>	810VA1Z001001	67 cm	3-530
<b>05763</b>	815VA1Z001001	45 cm	3-531
	815VA2Z001001	36 cm	
<b>05046</b>	819VA1Z000001 Stalak.		3-540

ŠIFRA VOKEL	WC MONOBLOK	
<b>05583</b>	821VA6Z0000F1 WC monoblok odvod u pod.	3-513
<b>05669</b>	821VA7Z0000F1 WC monoblok odvod u zid.	3-514
<b>05584</b>	828VA1Z00LRF1 Vodokotlić.	3-515

A	B	C	D	E
670	560	185	215	280
450	355	170	170	170
360	280	90	150	180

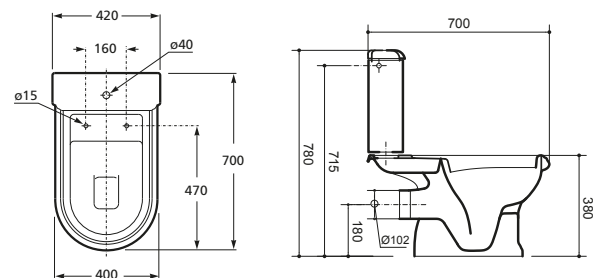
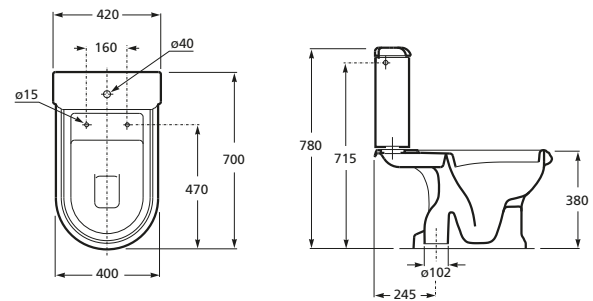
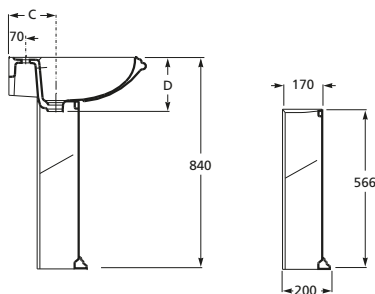
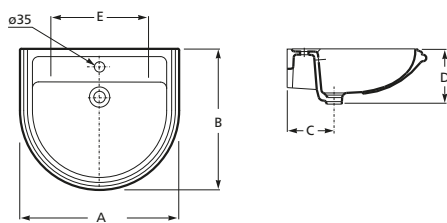



**ŠIFRA VOKEL**    **WC STOJEĆA**

<b>05036</b>	<b>822VA6Z0000F1</b> WC školjka odvod u pod.	3-510
<b>05378</b>	<b>822VA7Z0000F1</b> WC školjka odvod u zid.	3-511

**ŠIFRA VOKEL**    **STOJEĆI BIDE BIDET**

<b>05037</b>	<b>832VA1Z001001</b> Stojeći bide.	3-520
--------------	---------------------------------------	-------

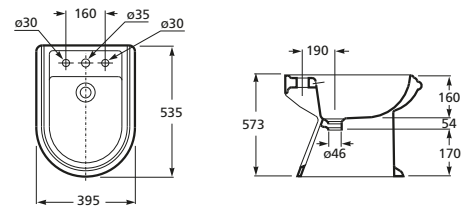
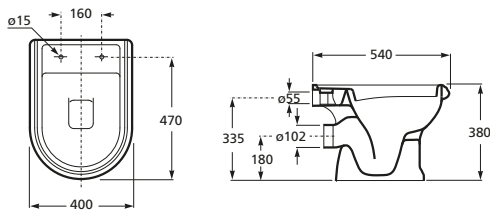
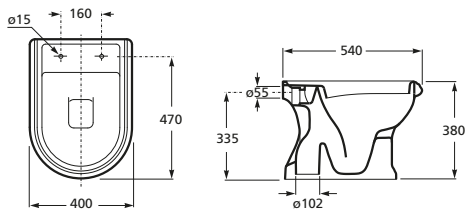





**INKER**  
**zoom**





## POLO

Svestranost definira dizajn serije Polo.

Njezine jednostavne, elegantne linije savršeno se kombiniraju sa svim modernim stilovima.

## INKER zoom





ŠIFRA VOKEL	UMIVAONIK	
<b>0450050</b>	810012Z001001	63 cm
<b>0450051</b>	810013Z001001	56 cm
<b>0450052</b>	810014Z001001	52 cm
<b>0450045</b>	819011Z000001 Stalak.	

ŠIFRA VOKEL	WC MONOBLOK	
<b>0450046</b>	821017Z0000F2	WC monoblok odvod u pod.
<b>0450047</b>	821016Z0000F1	WC monoblok odvod u zid.
<b>0450048</b>	828013Z00LRF1	Vodokotlić.

A	B	C	D
630	490	505	310
560	450	445	275
520	400	410	230

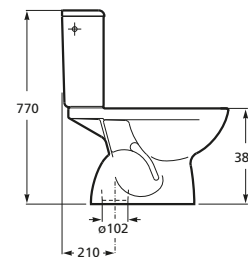
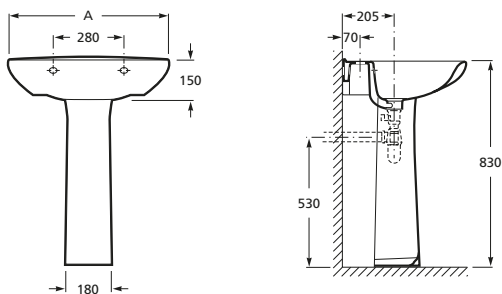
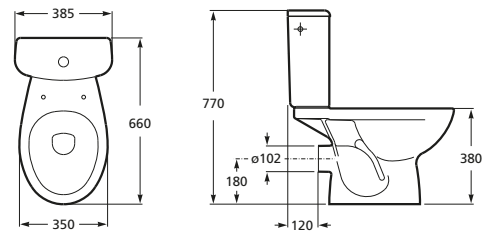
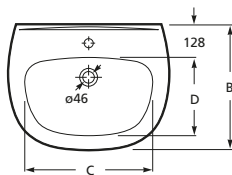



ŠIFRA  
VOKEL

WC STOJEĆA

**0450026**

**822016Z0000F2**  
WC stojeća odvod u zid.

**0450025**

**822017Z0000F2**  
WC stojeća odvod u pod.

ŠIFRA  
VOKEL

STOJEĆI BIDE

**0450049**

**832012Z0010F1**  
Stojeći bide.

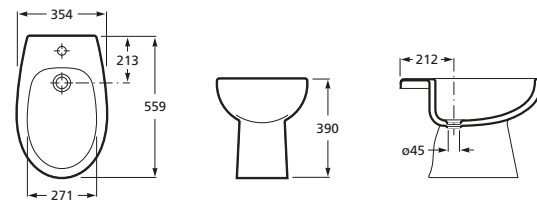
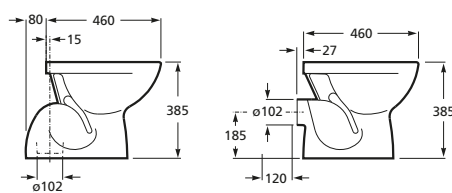
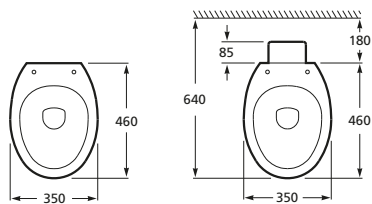



ŠIFRA VOKEL	UMIVAONIK	
<b>0450050</b>	<b>810012Z001001</b>	63 cm
<b>0450051</b>	<b>810013Z001001</b>	56 cm
<b>0450052</b>	<b>810014Z001001</b>	52 cm
<b>0450053</b>	<b>819012Z0000F1</b> Maska-Polustalak.	

ŠIFRA VOKEL	WC VISEĆI	
<b>0450054</b>	<b>820012Z000001</b>	WC Viseći.

A	B	C	D
630	490	505	310
560	450	445	275
520	400	410	230

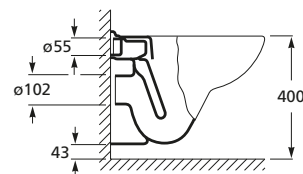
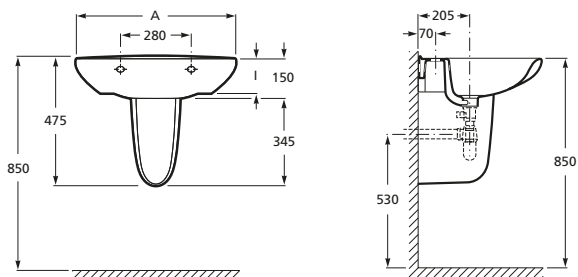
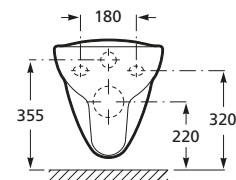
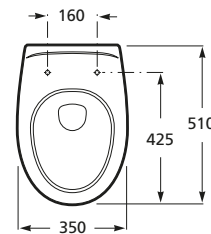
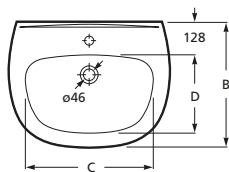



ŠIFRA  
VOKEL

VISEĆI BIDE

0450055

830012Z001001  
Viseći Bide.

ŠIFRA  
VOKEL

WC MONOBLOK

0450056

821016Z00LDF1  
Set WC monoblok odvod u zid, vodokotlić, mehanizam,  
WC daska, pribor za montažu.

0450057

821017Z00LDF1  
Set WC monoblok odvod u pod, vodokotlić, mehanizam,  
WC daska, pribor za montažu.

0450058

82D011Z000001  
WC daska duroplast antibakterijska.

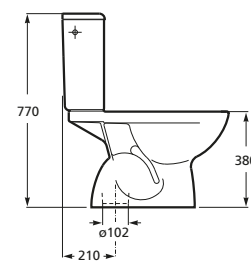
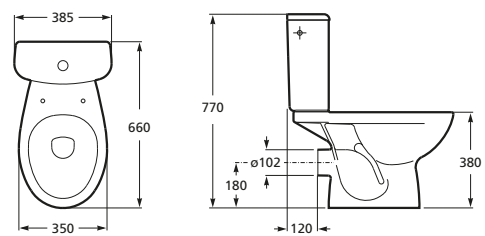
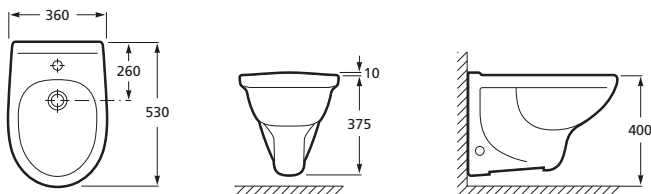





## INDIVIDUALNI ARTIKLI

Zoom nudi serije individualnih artikala za kompletiranje vašeg kupaonskog prostora u najmodernijem stilu.

**INKER**  
**zoom**

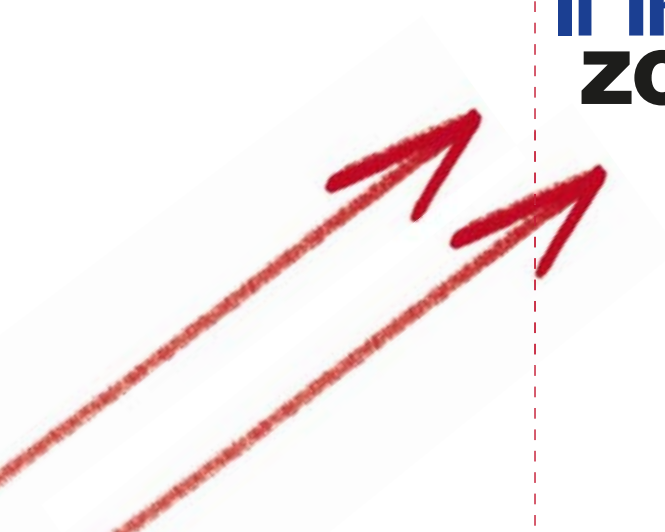

ŠIFRA VOKEL	UMIVAONIK		
<b>05357</b>	<b>815EK1Z001001</b>	46 cm	3-287
<b>05001</b>	<b>815EK3Z001001</b>	36 cm	3-246

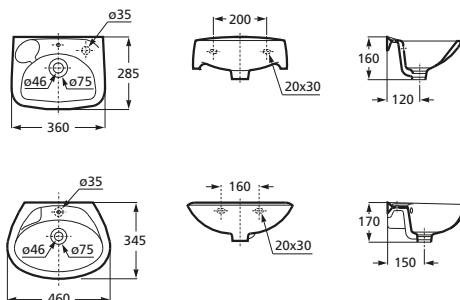

ŠIFRA VOKEL	UMIVAONIK		
<b>05513</b>	<b>815EK2Z001001</b>	40 cm	3-328

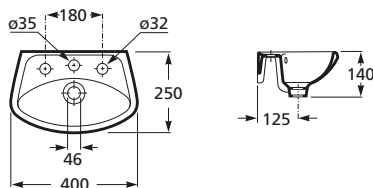

ŠIFRA VOKEL	UMIVAONIK		
	<b>810HR1Z001001</b>	82 cm	
	<b>STALAK JULIJA</b>		
<b>05019</b>	<b>819JU1Z000001</b>		3-277

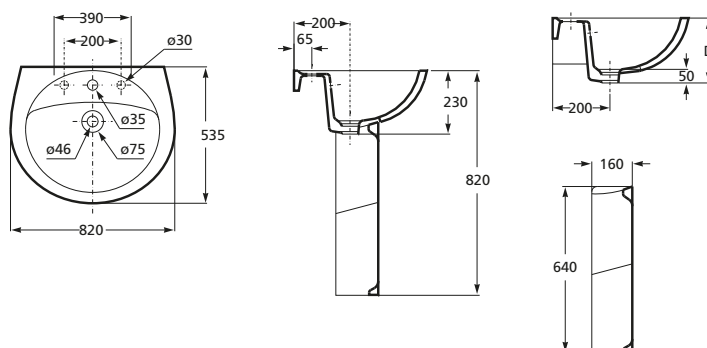

ŠIFRA VOKEL	UMIVAONIK		
<b>05384</b>	<b>812HR2Z001001</b>	47,5 cm Ugradbeni umivaonik (stepenasti).	3-047

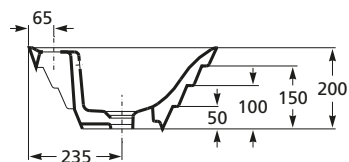
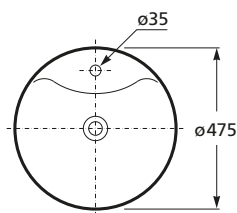

ŠIFRA VOKEL	UMIVAONIK		
<b>05771</b>	<b>815HR1Z001001</b>	43 cm Okrugli umivaonik.	3-043

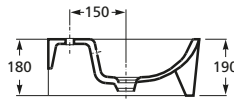
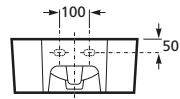
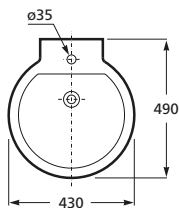

ŠIFRA VOKEL	UMIVAONIK
<b>05627</b>	<b>813HR1Z001001</b> 52,5 cm. Ugradbeni umivaonik na ploču. 3-298

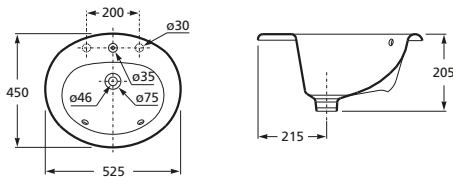

ŠIFRA VOKEL	UMIVAONIK
<b>05696</b>	<b>818HR1Z000001</b> 58 cm. Ugradbeni umivaonik ispod ploče. 3-320

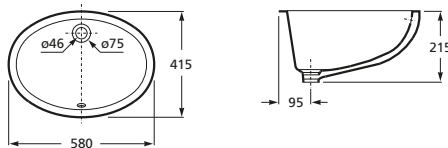

ŠIFRA VOKEL	UMIVAONIK
<b>05749</b>	<b>810HR2Z001001</b> 50 cm. Kutni umivaonik. 3-055

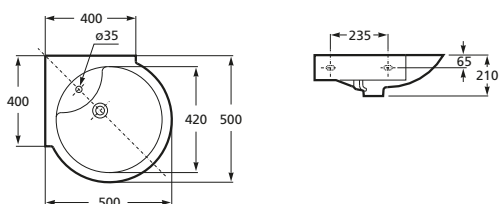

ŠIFRA VOKEL	UMIVAONIK		
<b>05773</b>	<b>810HR3Z001001</b>	80 cm. Umivaonik sa desnom pločom.	3-056
<b>05774</b>	<b>810HR4Z001001</b>	80 cm. Umivaonik sa lijevom pločom.	3-057

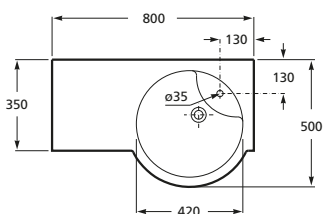
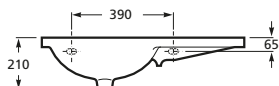
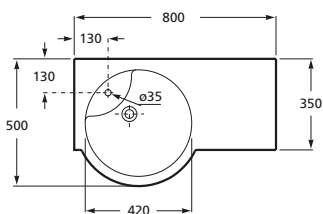

ŠIFRA VOKEL	UMIVAONIK - bez ormarića		
<b>05780</b>	<b>813HR5Z001001</b>	86 cm. Ugradbeni umivaonik nasadni.	3-085
<b>05779</b>	<b>813HR2Z001001</b>	75 cm. Ugradbeni umivaonik nasadni.	3-076
<b>0449158</b>	<b>813HR3Z001001</b>	65 cm. Ugradbeni umivaonik nasadni.	3-065
<b>05781</b>	<b>813HR4Z001001</b>	55 cm. Ugradbeni umivaonik nasadni.	3-074

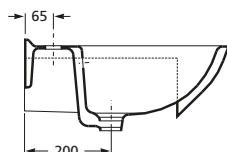
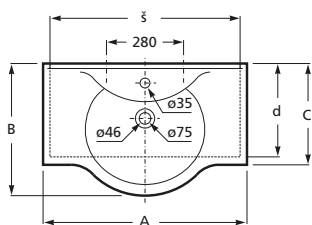

Ormarić				
A	B	C	š	d
860	500	370	830	330
750	480	370	700	330
650	460	370	600	350
550	460	370	500	350





ŠIFRA VOKEL	DJEČJA WC ŠKOLJKA	
<b>05418</b>	<b>822HR6Z0000F1</b> Dječja WC školjka.	3-229
<b>0449160</b>	82WHR1Z000001 WC daska dječja drvena	

ŠIFRA VOKEL	PISOAR	
<b>05681</b>	<b>840012Z0000FE</b> Pisoar s dovodom vode odozgora.	3-017
<b>05691</b>	<b>840011Z0000FE</b> Pisoar s dovodom vode odostraga.	3-018

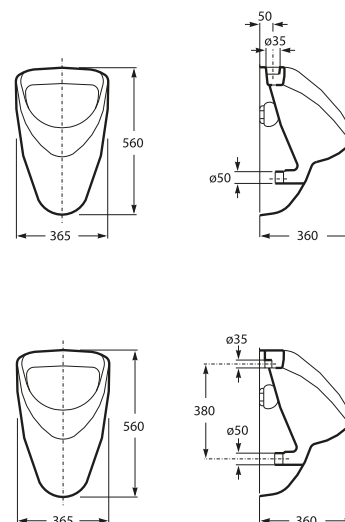
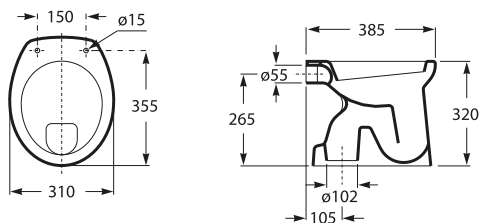

ŠIFRA VOKEL	PISOAR	
<b>0449164</b>	<b>840BU1Z000001</b> Pisoar s dovodom vode odozgora.	
<b>0449165</b>	<b>840BU2Z000001</b> Pisoar s dovodom vode odostraga.	

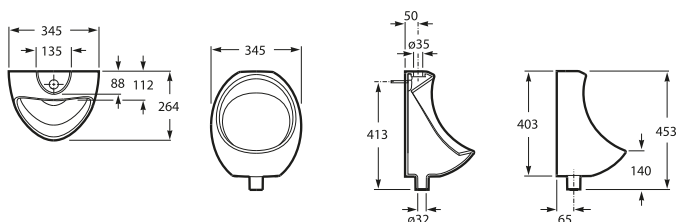



ŠIFRA VOKEL	PISOAR	
05106	840HR1Z0000F1	3-014

ŠIFRA VOKEL	TROKADERO	
05500	816HR1Z001001	3-101
0449156	REŠETKA ZA TROKADERO	T-60038

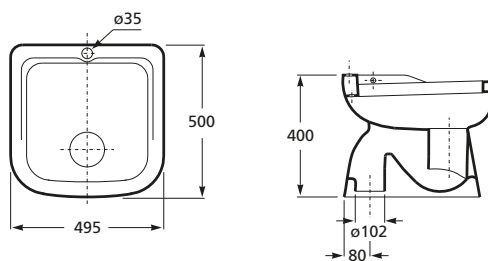
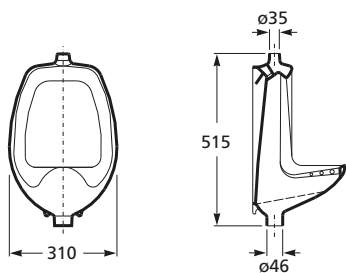

ŠIFRA VOKEL	ZIDNA POLICA		
	CA1HR2Z000001	45 cm	
05354	CA1HR1Z000001	60 cm	3-337

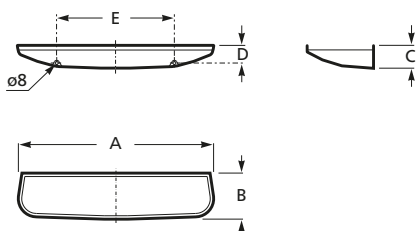

A	B	C	D	E
450	125	65	35	310
600	140	70	50	360



## NEO

Funkcionalnost serije NEO savršeno se kombinira s ljepotom njezinih oblika i stvara ambijent posebno stvoren za osobnu njegu.

**INKER**  
**zoom**





ŠIFRA VOKEL	UMIVAONIK		
<b>0450027</b>	810032Z001001	60 cm	
<b>05747</b>	810033Z001001	55 cm	3-321
<b>0450028</b>	810034Z001001	50 cm	
<b>0450029</b>	819031Z000001 Stalak.		

ŠIFRA VOKEL	WC MONOBLOK		
<b>0450030</b>	821036Z0000F1 WC monoblok odvod u zid.		
<b>0450031</b>	821037Z0000F1 WC monoblok odvod u pod.		
<b>0450032</b>	828032Z00LRF1 Vodokotlić.		

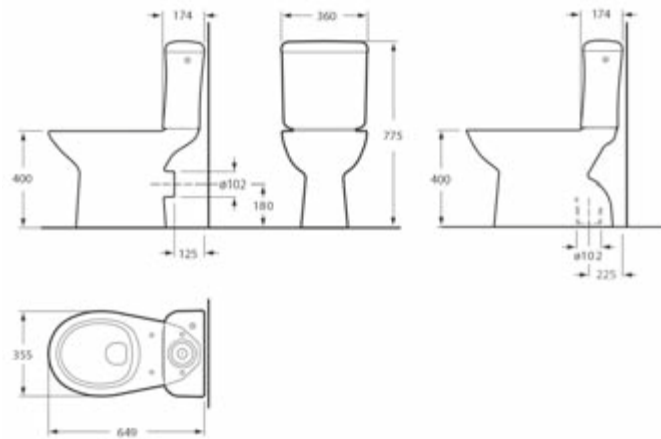
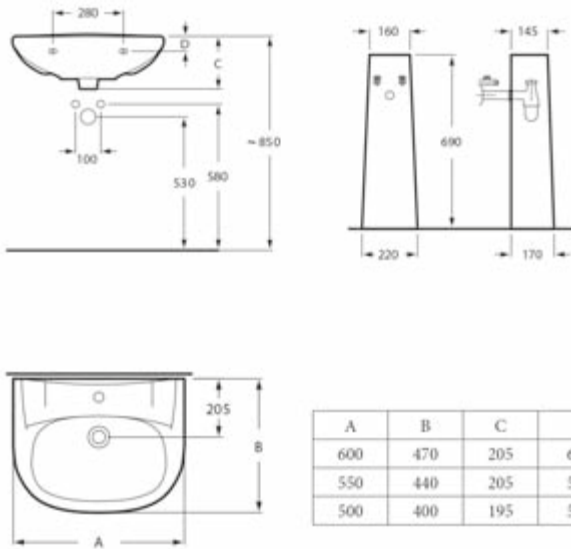

ŠIFRA VOKEL	UMIVAONIK		
<b>0450040</b>	815031Z001001	40 cm	

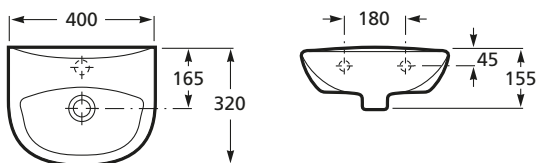



ŠIFRA VOKEL	WC MONOBLOK	ŠIFRA VOKEL	WC STOJEĆA
<b>0450034</b>	<b>821036Z00LPF1</b> Set WC monoblok odvod u zid, vodokotlić, mehanizam, WC daska, pribor za montažu.	<b>05689</b>	<b>822037Z0000F2</b> WC stojeća odvod u pod. 3-193
<b>0450035</b>	<b>821037Z00LPF1</b> Set WC monoblok odvod u pod, vodokotlić, mehanizam, WC daska, pribor za montažu.	<b>05707</b>	<b>822036Z0000F2</b> WC stojeća odvod u zid. 3-194
<b>0450036</b>	<b>82P031Z000001</b> WC daska polipropilen termoplast.		

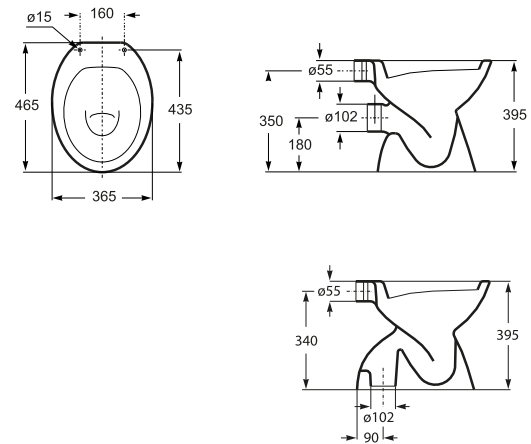
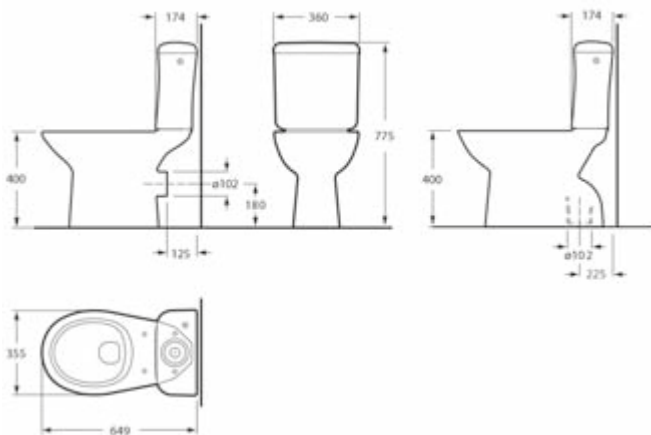

ŠIFRA VOKEL	STOJEĆI BIDE
<b>05768</b>	<b>832032Z0010F1</b> Stojeći bide. 3-329

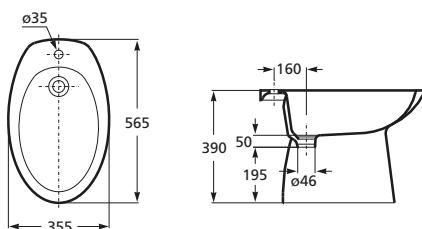





ŠIFRA VOKEL	UMIVAONIK		
<b>0450027</b>	810032Z001001	60 cm	
<b>05747</b>	810033Z001001	55 cm	3-321
<b>0450028</b>	810034Z001001	50 cm	
<b>0450039</b>	819032Z0000F1 Maska-Polustalak.		

ŠIFRA VOKEL	UMIVAONIK		
<b>0450040</b>	815031Z001001	40 cm	

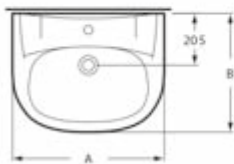
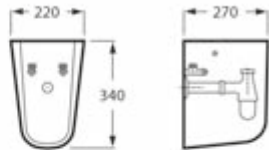
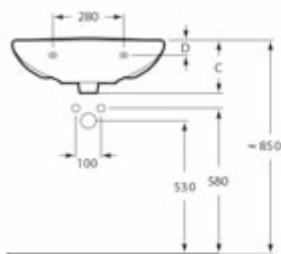

A	B	C	D
600	470	205	60
550	440	205	55
500	400	195	55

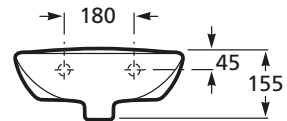
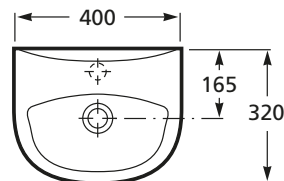

ŠIFRA VOKEL	WC VISEĆI	
<b>0449159</b>	820031Z000001 WC Viseći.	3-119

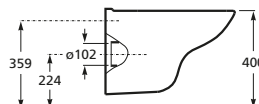
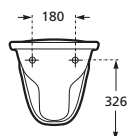
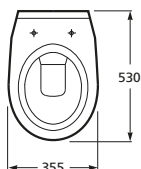

ŠIFRA VOKEL	VISEĆI BIDE
0450041	830032Z001001 Viseći Bide.

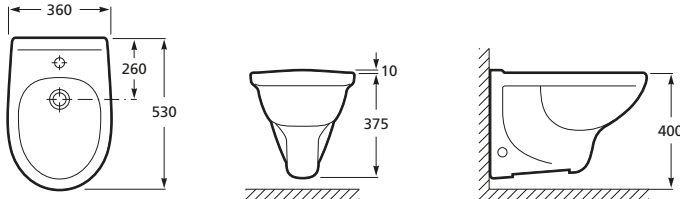



CAPE COD







PAIOVA 5











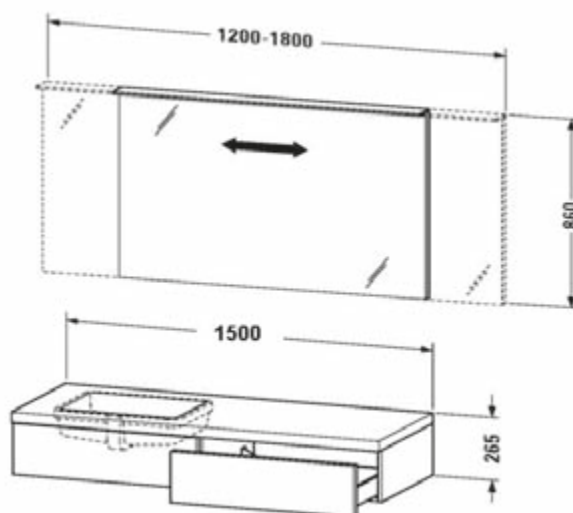

1150001	PLOČA ZA UMIVAONIK DELOS S LADICOM 565x1500 mm BOJA BRUŠENOG ORAHA ART.DL6991L6969
1150002	UGRADNI UMIVAONIK ZA DELOS 480 mm ART.0330480000
1150003	OGLEDALO SA LED RASVJETOM 860x1500 mm ART.DL7246L0000

PURA VIDA

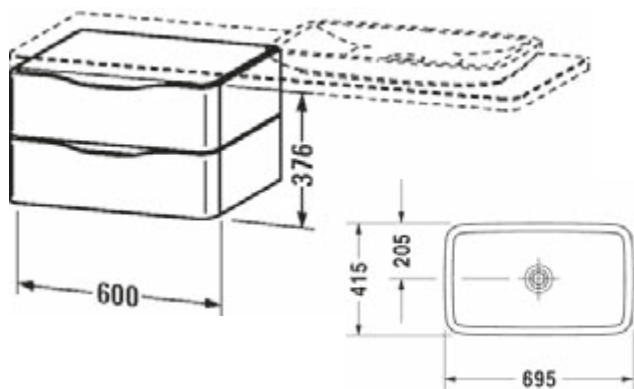
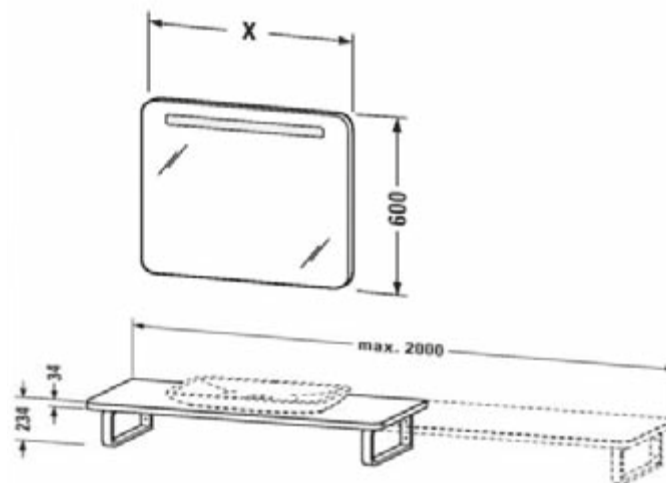

1150004	NADGRADNI UMIVAONIK PURA VIDA 700 mm ART.0370700000
1150005	VIŠEĆI BLOK SA DVIJE LADICE, BIJELI VISOKI SJAJ 600x376 mm ART.PV920108570
1150006	PLOČA IZNAD ORMARIĆA SA DRŽAČEM RUČNIKA BOJA BIJELO/EBANOVINA 34x550x1600 mm ART.PV071C08570
1150007	NOSAČ PLOČE S DRŽAČEM ZA RUČNIKE ART.PV993300000
1150008	OGLEDALO SA SVJETILJKOM PURA VIDA 600x1000 mm ART.PV942208585



# STARCK 2 SENSOWASH

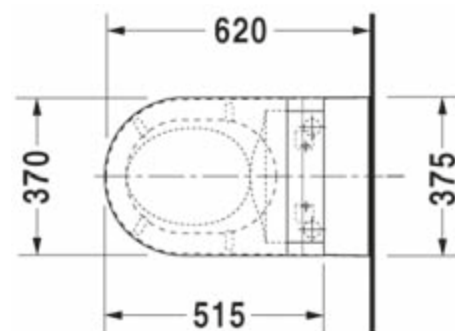
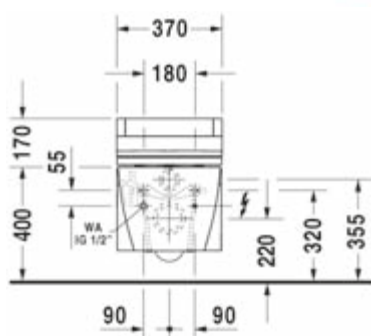
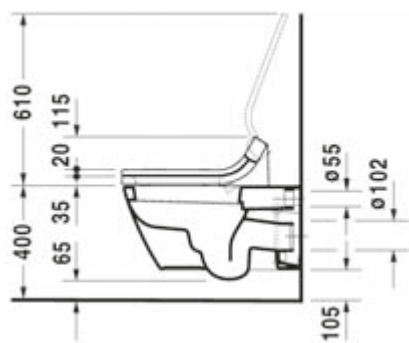
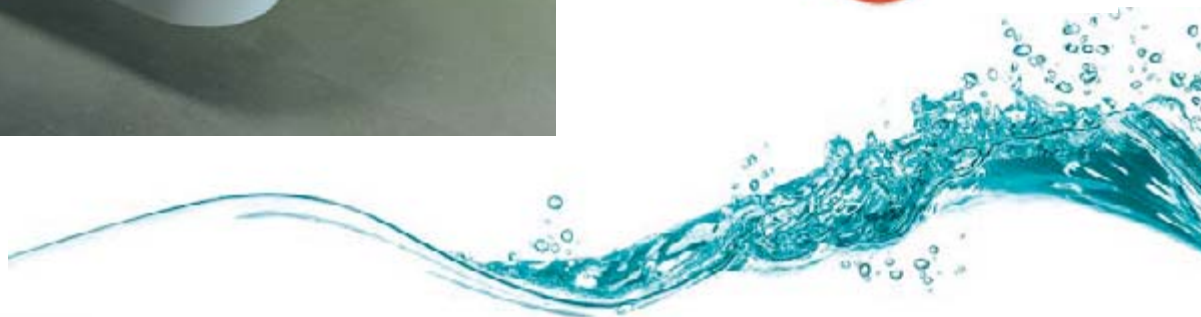

1150009	STARCK 2 WC ŠKOLJKA VISEĆA	ART.2533590000
1150010	SENSOWASH STARCK C WC DASKA-BIDE AC220V,1/2"	ART.610001002000300



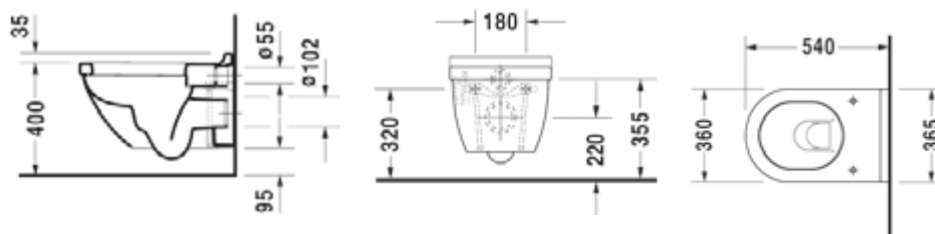

1150011	STARCK 3 WC ŠKOLJKA VISEĆA	ART.2225090000
1150012	WC DASKA SPOROSPUŠTAJUĆA STARCK 3	ART.0063890000

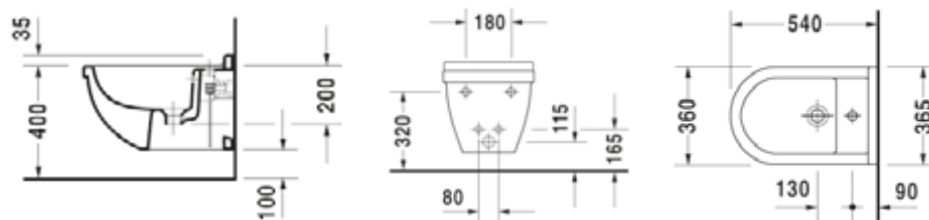

1150013	STARCK 3 BIDE VISEĆI	ART.2280150000
---------	----------------------	----------------

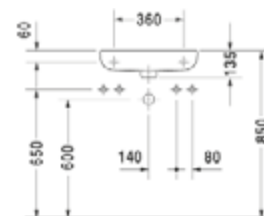
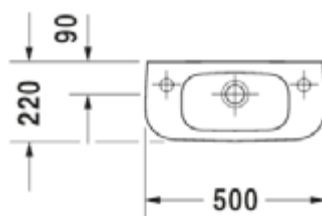

1150016	UMIVAONIK D-CODE 50x22 DESNI	ART.7065000082
---------	------------------------------	----------------

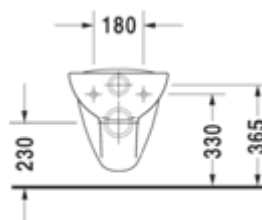

1150017	D-CODE WC ŠKOLJKA VISEĆA	ART.25350900002
1150015	WC DASKA SPOROSPUŠTAJUĆA D-CODE	ART.0067390000
1150021	WC DASKA D-CODE (BEZ AUTOMATSKOG ZATVARANJA)	ART.0067310000

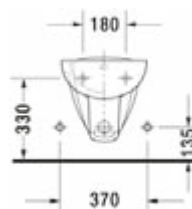
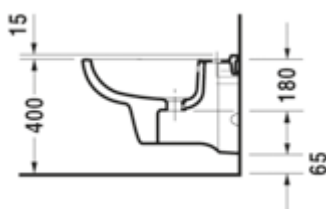

1150019	D-CODE BIDE VISEĆI 355x545	ART.22571500002
---------	----------------------------	-----------------

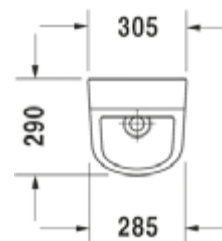
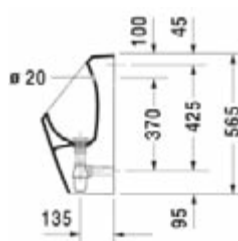
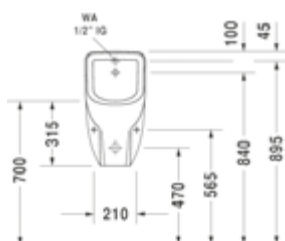

1150026	D-CODE PISOAR	ART.0829300000
---------	---------------	----------------





## D-CODE COMPACT SKRAĆENI

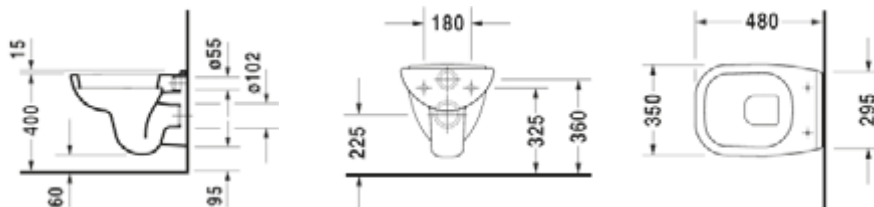

1150020	D-CODE COMPACT WC ŠKOLJKA VISEĆA SKRAĆENA 350x480 mm	ART.22110900002
1150015	WC DASKA SPOROSPUŠTAJUĆA D-CODE	ART.0067390000
1150021	WC DASKA D-CODE (BEZ AUTOMATSKOG ZATVARANJA)	ART.0067310000

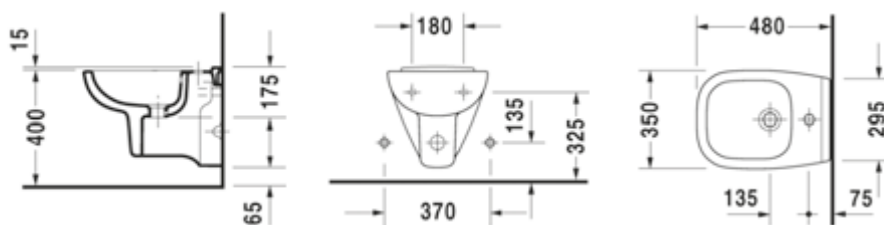

1150018	D-CODE COMPACT BIDE VISEĆI SKRAĆENI 350x480 mm	ART.22371500002
---------	---------------------------------------------------	-----------------



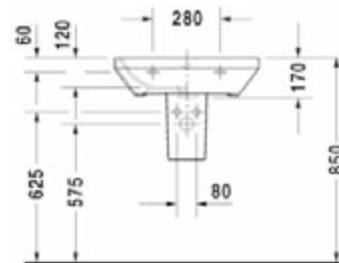
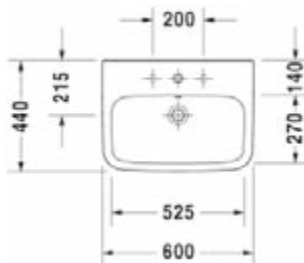

1150025	UMIVAONIK DURASTYLE 60 cm	ART.2319600000
---------	---------------------------	----------------

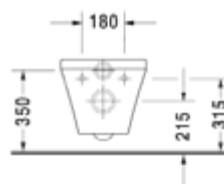
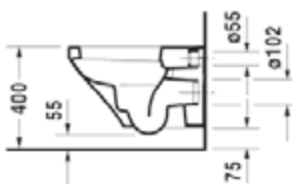

1150022	DURASTYLE WC ŠKOLJKA VISEĆA	ART.2536090000
1150024	WC DASKA SPOROSPUŠTAJUĆA DURASTYLE	ART.0063790000
1150023	WC DASKA DURASTYLE (BEZ AUTOMATSKOG ZATVARANJA)	ART.0063710000

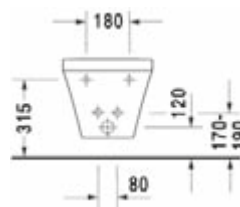
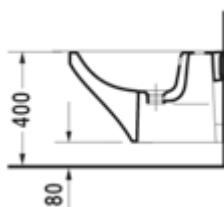

1150027	BIDE VISEĆI DURASTYLE	ART.2282150000
---------	-----------------------	----------------



## DURASTYLE Basic - Rimless

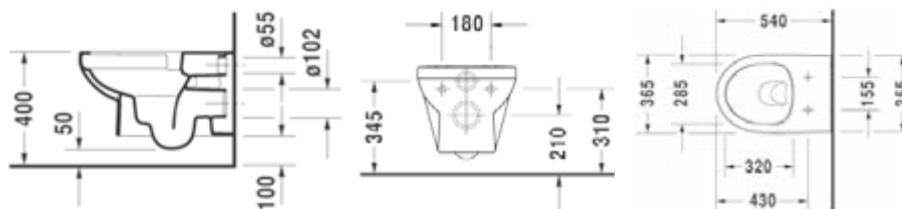

1150028	DURASTYLE BASIC RIMLESS WC ŠKOLJKA VISEĆA	ART.2562090000
1150029	WC DASKA SPOROSPUŠTAJUĆA DURASTYLE BASIC	ART.20790000

Rimless je nova tehnologija ispiranja bez vijenca koja ima slijedeće prednosti:

- Ne dozvoljava nakupljanje nečistoća
- Visoka higijena
- Lako čišćenje
- Snažno ispiranje
- Ušteda vode (4,5l)

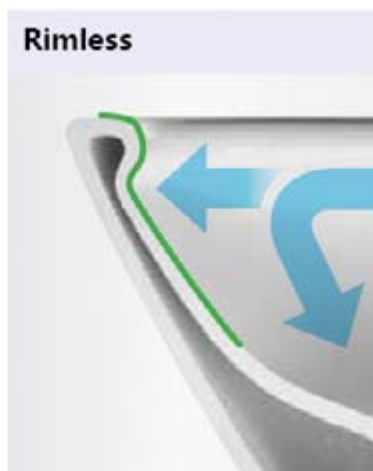



PuraVida











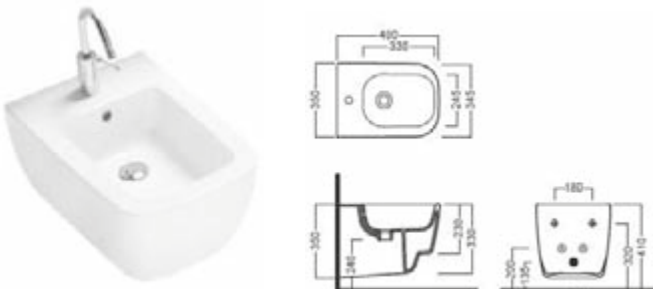



	<b>1124024</b>	FUSION STOJEĆA WC ŠKOLJKA ART.YXVD
	<b>1124007</b>	FUSION STOJEĆI BIDE ART.YOU6
	<b>1124001</b>	FUSION VISEĆA WC ŠKOLJKA ART.YXGQ
	<b>1124002</b>	FUSION VISEĆI BIDE ART.Y1D9
	<b>1124005</b>	FUSION PISOAR ART.YXC3

	<b>1124023</b>	WC ŠKOLJKA FUSION RIMLESS ART.Y1CC
	<b>1124018</b>	FUSION POKLOPAC S AMORTIZEROM ART.YXVX
	<b>1124013</b>	FUSION 48 VISEĆI BIDE ART.YXJ8
	<b>1124025</b>	FUSION 48 STOJEĆA WC ŠKOLJKA ART.YXZK
	<b>1124022</b>	AMORTIZIRAJUĆI WC POKLOPAC ART.YXB3
	<b>1124015</b>	FUSION 48 STOJEĆI BIDE ART.YXC9
	<b>1124021</b>	FUSION 48 VISEĆA WC ŠKOLJKA ART.YXZL
	<b>1124022</b>	AMORTIZIRAJUĆI WC POKLOPAC ART.YXB3



	<p><b>1124011</b></p>	<p>FUSION Q VISEĆA WC ŠKOLJKA</p>	<p>ART.YXWY</p>
	<p><b>1124010</b></p>	<p>FUSION Q VISEĆI BIDE</p>	<p>ART.YXV8</p>

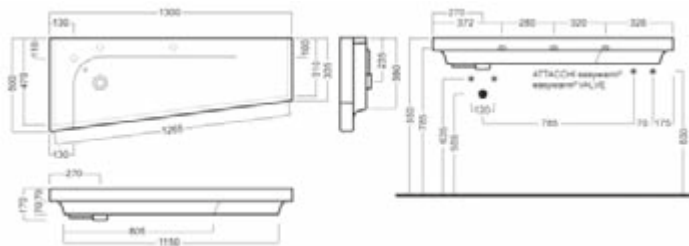

<b>1124003</b>	UMIVAONIK GRANDANGOLO 130 TRAPEZNI DESNI BEZ RUPE ZA SLAVINU	ART.YOXT
----------------	-----------------------------------------------------------------	----------

# G-FULL



<b>1124006</b>	G-FULL WC BLOK DESNI 140x50	ART.YXD0
<b>1124008</b>	G-FULL WC BLOK LIJEVI 140x50	ART.YXD1
<b>1124009</b>	PODKONSTRUKCIJA ZA WC BLOK F-FULL	ART.YXB7

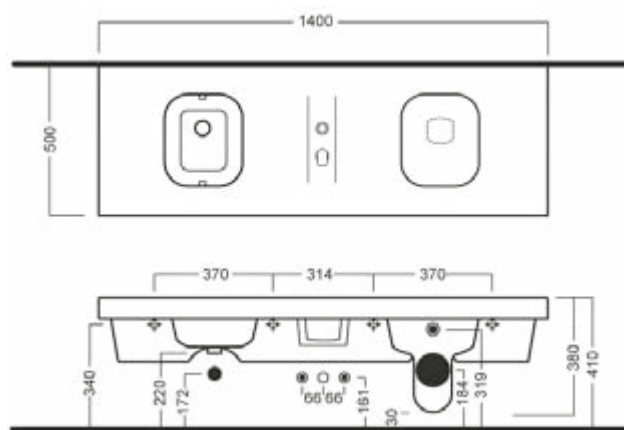
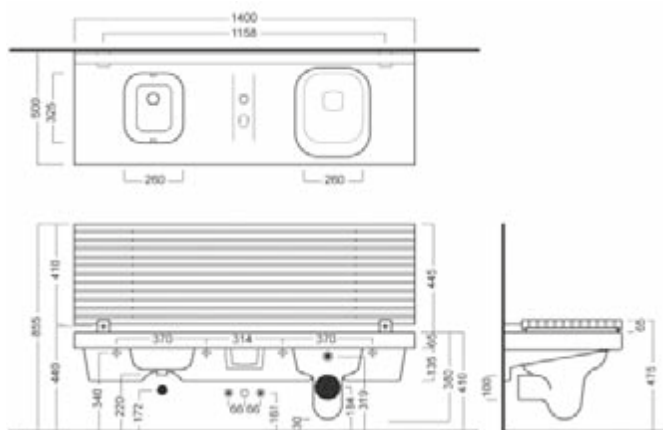



*hatria*  
**SCULTURE**





	<p><b>0444017</b></p>	<p>SCULTURE WC ŠKOLJKA</p>	<p>ART.YXZ3</p>																
	<p><b>46018</b></p>	<p>SCULTURE BIDE</p>	<p>ART.BI. YR42</p>																
<table border="1" data-bbox="272 1308 479 1412"> <thead> <tr> <th>SCULTURE</th> <th>A</th> <th>B</th> <th>C</th> </tr> </thead> <tbody> <tr> <td>lavabo 110</td> <td>755</td> <td>585</td> <td>250</td> </tr> <tr> <td>lavabo 77</td> <td>770</td> <td>585</td> <td>250</td> </tr> <tr> <td>lavabo 65</td> <td>650</td> <td>575</td> <td>245</td> </tr> </tbody> </table>	SCULTURE	A	B	C	lavabo 110	755	585	250	lavabo 77	770	585	250	lavabo 65	650	575	245	<p><b>46016</b></p>	<p>SCULTURE UMIVAONIK 77 cm</p>	<p>ART.BI. YR37</p>
SCULTURE	A	B	C																
lavabo 110	755	585	250																
lavabo 77	770	585	250																
lavabo 65	650	575	245																
<table border="1" data-bbox="272 1779 479 1882"> <thead> <tr> <th>SCULTURE</th> <th>A</th> <th>B</th> <th>C</th> </tr> </thead> <tbody> <tr> <td>lavabo 110</td> <td>755</td> <td>585</td> <td>250</td> </tr> <tr> <td>lavabo 77</td> <td>770</td> <td>585</td> <td>250</td> </tr> <tr> <td>lavabo 65</td> <td>650</td> <td>575</td> <td>245</td> </tr> </tbody> </table>	SCULTURE	A	B	C	lavabo 110	755	585	250	lavabo 77	770	585	250	lavabo 65	650	575	245	<p><b>46034</b></p>	<p>SCULTURE STALAK</p>	<p>ART.BI. YR39</p>
SCULTURE	A	B	C																
lavabo 110	755	585	250																
lavabo 77	770	585	250																
lavabo 65	650	575	245																
<table border="1" data-bbox="272 1779 479 1882"> <thead> <tr> <th>SCULTURE</th> <th>A</th> <th>B</th> <th>C</th> </tr> </thead> <tbody> <tr> <td>lavabo 110</td> <td>755</td> <td>585</td> <td>250</td> </tr> <tr> <td>lavabo 77</td> <td>770</td> <td>585</td> <td>250</td> </tr> <tr> <td>lavabo 65</td> <td>650</td> <td>575</td> <td>245</td> </tr> </tbody> </table>	SCULTURE	A	B	C	lavabo 110	755	585	250	lavabo 77	770	585	250	lavabo 65	650	575	245	<p><b>46016</b></p>	<p>SCULTURE UMIVAONIK 77cm</p>	<p>ART.BI. YR37</p>
SCULTURE	A	B	C																
lavabo 110	755	585	250																
lavabo 77	770	585	250																
lavabo 65	650	575	245																
<table border="1" data-bbox="272 1779 479 1882"> <thead> <tr> <th>SCULTURE</th> <th>A</th> <th>B</th> <th>C</th> </tr> </thead> <tbody> <tr> <td>lavabo 110</td> <td>755</td> <td>585</td> <td>250</td> </tr> <tr> <td>lavabo 77</td> <td>770</td> <td>585</td> <td>250</td> </tr> <tr> <td>lavabo 65</td> <td>650</td> <td>575</td> <td>245</td> </tr> </tbody> </table>	SCULTURE	A	B	C	lavabo 110	755	585	250	lavabo 77	770	585	250	lavabo 65	650	575	245	<p><b>46015</b></p>	<p>SCULTURE MASKA</p>	<p>ART.BI. YR40</p>
SCULTURE	A	B	C																
lavabo 110	755	585	250																
lavabo 77	770	585	250																
lavabo 65	650	575	245																

<table border="1" data-bbox="294 557 498 661"> <thead> <tr> <th>SCULTURE</th> <th>A</th> <th>B</th> <th>C</th> </tr> </thead> <tbody> <tr> <td>lavabo 110</td> <td>755</td> <td>585</td> <td>250</td> </tr> <tr> <td>lavabo 77</td> <td>770</td> <td>585</td> <td>250</td> </tr> <tr> <td>lavabo 65</td> <td>650</td> <td>575</td> <td>245</td> </tr> </tbody> </table>	SCULTURE	A	B	C	lavabo 110	755	585	250	lavabo 77	770	585	250	lavabo 65	650	575	245	<p><b>46033</b></p>	<p>SCULTURE INTEGRALE UMIVAONIK 110 cm ART.BI. YR38</p>
SCULTURE	A	B	C															
lavabo 110	755	585	250															
lavabo 77	770	585	250															
lavabo 65	650	575	245															
<table border="1" data-bbox="294 1007 498 1111"> <thead> <tr> <th>SCULTURE</th> <th>A</th> <th>B</th> <th>C</th> </tr> </thead> <tbody> <tr> <td>lavabo 110</td> <td>755</td> <td>585</td> <td>250</td> </tr> <tr> <td>lavabo 77</td> <td>770</td> <td>585</td> <td>250</td> </tr> <tr> <td>lavabo 65</td> <td>650</td> <td>575</td> <td>245</td> </tr> </tbody> </table>	SCULTURE	A	B	C	lavabo 110	755	585	250	lavabo 77	770	585	250	lavabo 65	650	575	245	<p><b>46033</b></p>	<p>SCULTURE INTEGRALE UMIVAONIK 110 cm ART.BI. YR38</p>
SCULTURE	A	B	C															
lavabo 110	755	585	250															
lavabo 77	770	585	250															
lavabo 65	650	575	245															
	<p><b>46055</b></p>	<p>SCULTURE BIDE VISEĆI ART.BI. Y0BF</p>																
	<p><b>46056</b></p>	<p>WC ŠKOLJKA SCULTURE MONOBLOK ART.BI. YXZ4</p>																
	<p><b>0442016</b></p>	<p>WC POKLOPAC SCULTURE ART.Y0I5</p>																
	<p><b>46057</b></p>	<p>VODOKOTLIĆ SCULTURE MONOBLOK ART.BI. Y0FQ</p>																





*hatria*  
**DAYTIME**







*hatria*  
**DOLCEVITA**

	<b>0446012</b>	DOLCEVITA WC ŠKOLJKA BALTIK	ART.YXXP
	<b>0446013</b>	DOLCEVITA WC ŠKOLJKA PODNA	ART.YXXN
	<b>46069</b>	DOLCEVITA BIDE	ART.BI.YOET
	<b>0446013</b>	DOLCEVITA WC ŠKOLJKA PODNA	ART.YXXN
	<b>0446012</b>	DOLCEVITA WC ŠKOLJKA BALTIK	ART.YXXP

	<p><b>46074</b></p>	<p>DOLCEVITA UMIVAONIK 75 cm</p>	<p>ART.BI. Y0EJ</p>
	<p><b>46075</b></p>	<p>DOLCEVITA UMIVAONIK 70 cm</p>	<p>ART.BI. Y0EX</p>
	<p><b>46065</b></p>	<p>LAVABO DOLCEVITA OVALNI 75 cm</p>	<p>ART.BI. Y0EW</p>
	<p><b>46052</b></p>	<p>LAVABO DOLCEVITA 100</p>	<p>ART.BI. Y0FO</p>
	<p><b>46052</b></p>	<p>LAVABO DOLCEVITA 100</p>	<p>ART.BI. Y0FO</p>
	<p><b>46058</b></p>	<p>NOGICA ZA LAVABO DOLCEVITA (1 KOMAD)</p>	<p>ART.BI. Y0FN</p>



*hatria* **HAPPY HOUR**

	<p><b>0529006</b></p>	<p>UMIVAONIK HAPPY HOUR 700x400 ART.Y0M9</p>
	<p><b>0529003</b></p>	<p>UMIVAONIK HAPPY HOUR 475x475 ART.Y0M6</p>
	<p><b>0529002</b></p>	<p>UMIVAONIK HAPPY HOUR 480x480 ART.Y0M7</p>
	<p><b>46141</b></p>	<p>UMIVAONIK HAPPY HOUR 480x480 ART.Y0M8</p>
	<p><b>0529004</b></p>	<p>UMIVAONIK HAPPY HOUR 398x398 ART.Y0QR</p>
	<p><b>0529005</b></p>	<p>UMIVAONIK HAPPY HOUR 550x405 ART.Y0QQ</p>



		<b>0529007</b> UMIVAONIK HAPPY HOUR 440x440 [UGRADNJA NA PLOČU] ART.YXSK
		<b>0529008</b> UMIVAONIK HAPPY HOUR 440x440 [UGRADNJA ISPOD PLOČE] ART. YXSP
		<b>0529009</b> UMIVAONIK HAPPY HOUR 500x380 [UGRADNJA NA PLOČU] ART. YXSL
		<b>0529010</b> UMIVAONIK HAPPY HOUR 500x380 [UGRADNJA ISPOD PLOČE] ART. YXSQ
		<b>0529011</b> UMIVAONIK HAPPY HOUR 470x470 [UGRADNJA NA PLOČU] ART. YXSJ
		<b>0529012</b> UMIVAONIK HAPPY HOUR 440x440 ART.Y1A218
		<b>0529018</b> UMIVAONIK HAPPY HOUR 440x440 BIJELO ZLATO ART.Y1D1
		<b>0529013</b> UMIVAONIK HAPPY HOUR 500x380 ART. Y1A618



*hatria*  
**NIDO**



	<p><b>1135001</b> UMIVAONIK NIDO 56 cm</p>	<p>ART.Y0TT</p>
	<p><b>1135002</b> MASKA ZA UMIVAONIK NIDO</p> <p><b>1135003</b> STALAK ZA UMIVAONIK NIDO</p>	<p>ART.Y0R6</p> <p>ART.YH30</p>
	<p><b>1135012</b> UMIVAONIK NIDO 68 cm</p> <p><b>1135002</b> MASKA ZA UMIVAONIK NIDO</p> <p><b>1135003</b> STALAK ZA UMIVAONIK NIDO</p>	<p>ART.Y0QX</p> <p>ART.Y0R6</p> <p>ART.YH30</p>
	<p><b>1135005</b> UMIVAONIK NIDO 75 cm</p>	<p>ART.Y0R2</p>

	<p><b>1135006</b></p>	<p>WC ŠKOLJKA VISEĆA NIDO</p>	<p>ART.YXMD</p>
	<p><b>1135009</b></p>	<p>BIDE VISEĆI NIDO</p>	<p>ART.YXNI</p>
	<p><b>1135010</b></p>	<p>WC ŠKOLJKA STOJEĆA NIDO</p>	<p>ART.YXBW</p>
	<p><b>1135011</b></p>	<p>BIDE STOJEĆI NIDO</p>	<p>ART.YXBU</p>
	<p><b>1135007</b></p>	<p>WC POKLOPAC NIDO</p>	<p>ART.YXWX</p>
	<p><b>1135007</b></p>	<p>WC POKLOPAC NIDO</p>	<p>ART.YXWX</p>
	<p><b>1135018</b></p>	<p>WC POKLOPAC NIDO AMORTIZIRAJUĆI</p>	<p>ART.YXWW</p>

	<p><b>1135013</b></p>	<p>WC ŠKOLJKA STOJEĆA RAVNA NIDO ART.Y0QU</p>
	<p><b>1135014</b></p>	<p>BIDE STOJEĆI RAVNI NIDO ART.Y0QW</p>
	<p><b>1135013</b> <b>1135016</b> <b>1135007</b></p>	<p>WC ŠKOLJKA STOJEĆA RAVNA NIDO ART.Y0QU</p> <p>NIDO VODOKOTLIĆ ART.Y0YN</p> <p>NIDO WC POKLOPAC ART.YWXW</p>













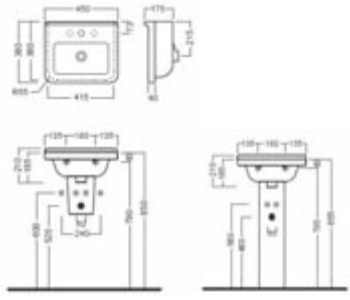

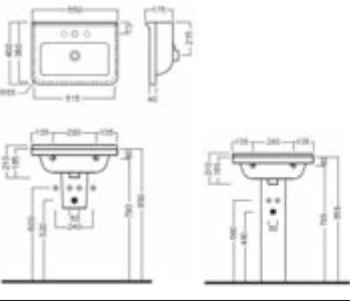

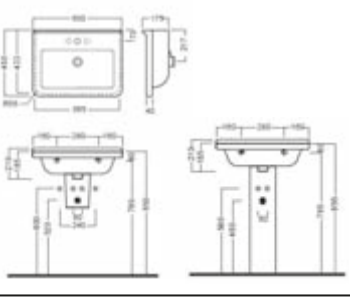

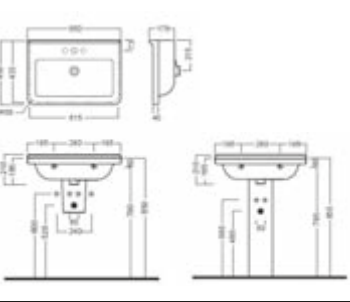

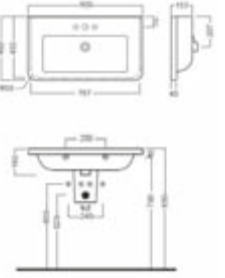
**ERIKA PRO Q**

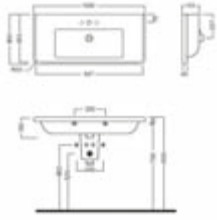

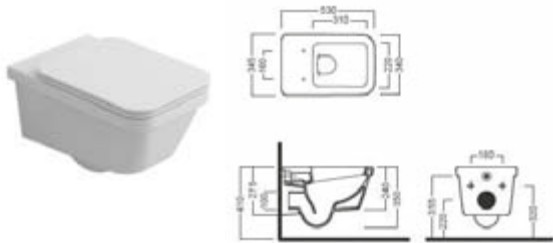
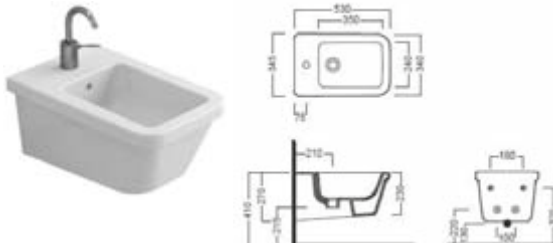
*hatria*

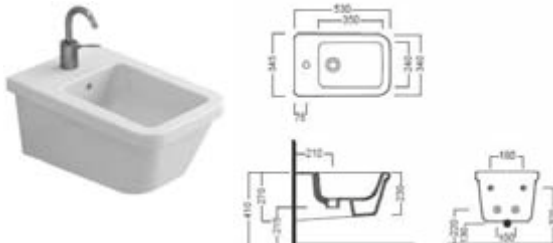

 	<b>0447012</b>	UMIVAONIK ERIKA PRO 45 cm	ART.YXBJ
	<b>0447013</b>	MASKA ZA UMIVAONIK ERIKA PRO	ART.YXBK
	<b>0447014</b>	STALAK ZA UMIVAONIK ERIKA PRO	ART.YXHE
 	<b>0447015</b>	UMIVAONIK ERIKA PRO 55 cm	ART.YXBI
	<b>0447013</b>	MASKA ZA UMIVAONIK ERIKA PRO	ART.YXBK
	<b>0447014</b>	STALAK ZA UMIVAONIK ERIKA PRO	ART.YXHE
 	<b>0447016</b>	UMIVAONIK ERIKA PRO 60 cm	ART.YXBH
	<b>0447013</b>	MASKA ZA UMIVAONIK ERIKA PRO	ART.YXBK
	<b>0447014</b>	STALAK ZA UMIVAONIK ERIKA PRO	ART.YXHE
 	<b>0447017</b>	UMIVAONIK ERIKA PRO 65 cm	ART.YXBE
	<b>0447013</b>	MASKA ZA UMIVAONIK ERIKA PRO	ART.YXBK
	<b>0447014</b>	STALAK ZA UMIVAONIK ERIKA PRO	ART.YXHE
 	<b>0447018</b>	UMIVAONIK ERIKA PRO 80 cm	ART.YXE9
	<b>0447013</b>	MASKA ZA UMIVAONIK ERIKA PRO	ART.YXBK
 	<b>0447019</b>	UMIVAONIK ERIKA PRO 100 cm	ART.YXEA
	<b>0447013</b>	MASKA ZA UMIVAONIK ERIKA PRO	ART.YXBK

	<b>0447025</b>	WC ŠKOLJKA VISEĆA ERIKA PRO Q	ART.YXJO
	<b>0447035</b>	WC POKLOPAC ERIKA PRO Q	ART.YXJL
	<b>0447026</b>	WC POKLOPAC ERIKA PRO Q SPOROSPUŠTAJUĆI	ART.YXJM
	<b>0447027</b>	BIDE VISEĆI ERIKA PRO Q	ART.YXHW
	<b>0447028</b>	MONOBLOK WC ŠKOLJKA ERIKA PRO Q	ART.YXJ2
	<b>0447029</b>	VODOKOTLIĆ MONOBLOK ERIKA PRO Q	ART.YXGR
	<b>0447035</b>	WC POKLOPAC ERIKA PRO Q	ART.YXJL
	<b>0447026</b>	WC POKLOPAC ERIKA PRO Q SPOROSPUŠTAJUĆI	ART.YXJM

*hatria*  
**ERIKA PRO**



	<b>0447012</b>	UMIVAONIK ERIKA PRO 45 cm	ART.YXBJ
	<b>0447013</b>	MASKA ZA UMIVAONIK ERIKA PRO	ART.YXBK
	<b>0447014</b>	STALAK ZA UMIVAONIK ERIKA PRO	ART.Y0TC
	<b>0447015</b>	UMIVAONIK ERIKA PRO 55 cm	ART.YXBI
	<b>0447013</b>	MASKA ZA UMIVAONIK ERIKA PRO	ART.YXBK
	<b>0447014</b>	STALAK ZA UMIVAONIK ERIKA PRO	ART.Y0TC
	<b>0447016</b>	UMIVAONIK ERIKA PRO 60 cm	ART.YXBH
	<b>0447017</b>	UMIVAONIK ERIKA PRO 65 cm	ART.YXBE
	<b>0447013</b>	MASKA ZA UMIVAONIK ERIKA PRO	ART.YXBK
	<b>0447018</b>	UMIVAONIK ERIKA PRO 80 cm	ART.YXE9
	<b>0447013</b>	MASKA ZA UMIVAONIK ERIKA PRO	ART.YXBK
	<b>0447019</b>	UMIVAONIK ERIKA PRO 100 cm	ART.YXEA
	<b>0447013</b>	MASKA ZA UMIVAONIK ERIKA PRO	ART.YXBK



	<b>0447020</b> WC ŠKOLJKA VISEĆA ERIKA PRO	ART.YXBS
	<b>0447032</b> POKLOPAC ERIKA PRO	ART.YXAH
	<b>0447021</b> BIDE VISEĆI ERIKA PRO	ART.YXBT
	<b>0447022</b> WC ŠKOLJKA STOJEĆA ERIKA PRO	ART.YXBR
	<b>0447032</b> POKLOPAC ERIKA PRO	ART.YXAH
	<b>0447023</b> BIDE STOJEĆI ERIKA PRO	ART.YXBP
	<b>0447024</b> MONOBLOK WC ŠKOLJKA ERIKA PRO	ART.YXBQ
	<b>0447033</b> VODOKOTLIĆ S MECHANIZMOM ERIKA PRO	ART.YXG3
	<b>0447032</b> POKLOPAC ERIKA PRO	ART.YXAH
	<b>0447030</b> WC ŠKOLJKA RIMLESS ERIKA PRO	ART.Y1CB
	<b>0447031</b> POKLOPAC S AMORTIZEROM ERIKA PRO	ART.YXAG

*hatria*  
**ERIKA**



	<b>46076</b>	ERIKA WC ŠKOLJKA VISEĆA	ART.BI. YORH																														
	<b>46028</b>	ERIKA WC POKLOPAC	ART.BI. YOSB																														
	<b>46078</b>	ERIKA BIDE VISEĆI	ART.BI. YOT6																														
<table border="1" data-bbox="244 1111 728 1180"> <thead> <tr> <th>ERIKA</th> <th>A</th> <th>B</th> <th>C</th> <th>D</th> <th>E</th> <th>F</th> <th>G</th> <th>H</th> <th>I</th> </tr> </thead> <tbody> <tr> <td>lavabo 66</td> <td>660</td> <td>530</td> <td>185</td> <td>210</td> <td>800</td> <td>280</td> <td>620</td> <td>530</td> <td>80</td> </tr> <tr> <td>lavabo 60</td> <td>600</td> <td>495</td> <td>185</td> <td>200</td> <td>800</td> <td>280</td> <td>610</td> <td>530</td> <td>80</td> </tr> </tbody> </table>	ERIKA	A	B	C	D	E	F	G	H	I	lavabo 66	660	530	185	210	800	280	620	530	80	lavabo 60	600	495	185	200	800	280	610	530	80	<b>0447008</b>	ERIKA UMIVAONIK 60 cm	ART.YOT9
ERIKA	A	B	C	D	E	F	G	H	I																								
lavabo 66	660	530	185	210	800	280	620	530	80																								
lavabo 60	600	495	185	200	800	280	610	530	80																								
	<b>0447009</b>	ERIKA UMIVAONIK 66 cm	ART.YOT8																														
	<b>0447010</b>	ERIKA MASKA ZA UMIVAONIK	ART.Y496																														
<table border="1" data-bbox="386 1662 786 1731"> <thead> <tr> <th>ERIKA</th> <th>A</th> <th>B</th> <th>C</th> <th>D</th> <th>E</th> <th>F</th> <th>G</th> </tr> </thead> <tbody> <tr> <td>lavabo 66</td> <td>660</td> <td>530</td> <td>185</td> <td>210</td> <td>770</td> <td>280</td> <td>820</td> </tr> <tr> <td>lavabo 60</td> <td>600</td> <td>495</td> <td>185</td> <td>200</td> <td>755</td> <td>280</td> <td>805</td> </tr> </tbody> </table>	ERIKA	A	B	C	D	E	F	G	lavabo 66	660	530	185	210	770	280	820	lavabo 60	600	495	185	200	755	280	805	<b>0447008</b>	ERIKA UMIVAONIK 60 cm	ART.YOT9						
ERIKA	A	B	C	D	E	F	G																										
lavabo 66	660	530	185	210	770	280	820																										
lavabo 60	600	495	185	200	755	280	805																										
	<b>0447009</b>	ERIKA UMIVAONIK 66 cm	ART.YOT8																														
	<b>0447011</b>	ERIKA STALAK ZA UMIVAONIK	ART.YM76																														



*hatria*

**VANITY WASHBASIN**



**MARINE**



**CAROLINE**

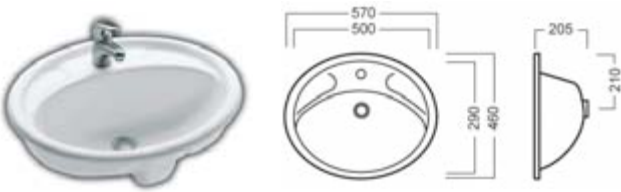
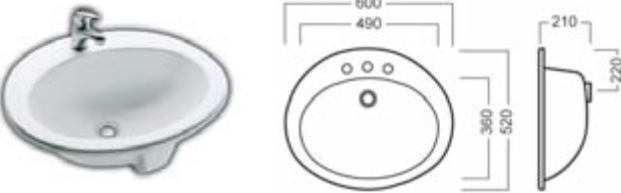
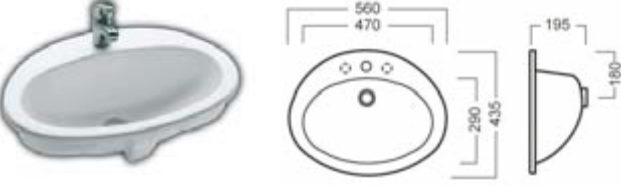

**OVALINE**

	<p><b>46079</b></p>	<p>CAROLINE UMIVAONIK UGRADNI 570x460mm</p> <p>ART.BI. Y631</p>
	<p><b>46041</b></p>	<p>OVALINE UMIVAONIK 600x52mm</p> <p>ART.BI. Y671</p>
	<p><b>46080</b></p>	<p>MARINE UMIVAONIK 560x435mm</p> <p>ART.BI. Y751</p>

 <table border="1" data-bbox="343 461 827 512"> <thead> <tr> <th>SOPHIE</th> <th>A</th> <th>B</th> <th>C</th> <th>D</th> <th>E</th> <th>F</th> <th>G</th> <th>H</th> <th>I</th> </tr> </thead> <tbody> <tr> <td>lavabo 56</td> <td>560</td> <td>450</td> <td>190</td> <td>515</td> <td>350</td> <td>170</td> <td>190</td> <td>-</td> <td>-</td> </tr> </tbody> </table>	SOPHIE	A	B	C	D	E	F	G	H	I	lavabo 56	560	450	190	515	350	170	190	-	-	<b>46114</b> UMIVAONIK SOPHIE 56 cm          <b>46121</b> NOSAČ UMIVAONIKA	ART.Y0HG          ART.Y0PV
SOPHIE	A	B	C	D	E	F	G	H	I													
lavabo 56	560	450	190	515	350	170	190	-	-													
 <table border="1" data-bbox="343 792 827 842"> <thead> <tr> <th>SOPHIE</th> <th>A</th> <th>B</th> <th>C</th> <th>D</th> <th>E</th> <th>F</th> <th>G</th> <th>H</th> <th>I</th> </tr> </thead> <tbody> <tr> <td>lavabo 75</td> <td>750</td> <td>495</td> <td>210</td> <td>710</td> <td>330</td> <td>190</td> <td>280</td> <td>-</td> <td>-</td> </tr> </tbody> </table>	SOPHIE	A	B	C	D	E	F	G	H	I	lavabo 75	750	495	210	710	330	190	280	-	-	<b>46115</b> UMIVAONIK SOPHIE 75 cm          <b>46120</b> DRŽAČ RUČNIKA 75 cm          <b>46121</b> NOSAČ UMIVAONIKA	ART.Y0FG          ART.Y0Q0          ART.Y0PV
SOPHIE	A	B	C	D	E	F	G	H	I													
lavabo 75	750	495	210	710	330	190	280	-	-													
 <table border="1" data-bbox="343 1113 827 1164"> <thead> <tr> <th>SOPHIE</th> <th>A</th> <th>B</th> <th>C</th> <th>D</th> <th>E</th> <th>F</th> <th>G</th> <th>H</th> <th>I</th> </tr> </thead> <tbody> <tr> <td>lavabo 86</td> <td>865</td> <td>500</td> <td>215</td> <td>820</td> <td>330</td> <td>190</td> <td>280</td> <td>-</td> <td>-</td> </tr> </tbody> </table>	SOPHIE	A	B	C	D	E	F	G	H	I	lavabo 86	865	500	215	820	330	190	280	-	-	<b>46116</b> UMIVAONIK SOPHIE 86 cm          <b>46122</b> DRŽAČ RUČNIKA 86 cm          <b>46121</b> NOSAČ UMIVAONIKA	ART.Y0AN          ART.Y0PU          ART.Y0PV
SOPHIE	A	B	C	D	E	F	G	H	I													
lavabo 86	865	500	215	820	330	190	280	-	-													
 <table border="1" data-bbox="343 1435 827 1485"> <thead> <tr> <th>SOPHIE</th> <th>A</th> <th>B</th> <th>C</th> <th>D</th> <th>E</th> <th>F</th> <th>G</th> <th>H</th> <th>I</th> </tr> </thead> <tbody> <tr> <td>lavabo 95</td> <td>950</td> <td>500</td> <td>195</td> <td>995</td> <td>330</td> <td>195</td> <td>280</td> <td>185</td> <td>185</td> </tr> </tbody> </table>	SOPHIE	A	B	C	D	E	F	G	H	I	lavabo 95	950	500	195	995	330	195	280	185	185	<b>46117</b> UMIVAONIK SOPHIE 95 cm          <b>46123</b> DRŽAČ RUČNIKA 95 cm          <b>46121</b> NOSAČ UMIVAONIKA	ART.Y0HC          ART.Y0PT          ART.Y0PV
SOPHIE	A	B	C	D	E	F	G	H	I													
lavabo 95	950	500	195	995	330	195	280	185	185													
 <table border="1" data-bbox="343 1756 827 1806"> <thead> <tr> <th>SOPHIE</th> <th>A</th> <th>B</th> <th>C</th> <th>D</th> <th>E</th> <th>F</th> <th>G</th> <th>H</th> <th>I</th> </tr> </thead> <tbody> <tr> <td>lavabo 105</td> <td>1050</td> <td>495</td> <td>220</td> <td>1010</td> <td>330</td> <td>200</td> <td>280</td> <td>170</td> <td>170</td> </tr> </tbody> </table>	SOPHIE	A	B	C	D	E	F	G	H	I	lavabo 105	1050	495	220	1010	330	200	280	170	170	<b>46118</b> UMIVAONIK SOPHIE 105 cm          <b>46124</b> DRŽAČ RUČNIKA 105 cm          <b>46121</b> NOSAČ UMIVAONIKA	ART.YU90          ART.Y0PS          ART.Y0PV
SOPHIE	A	B	C	D	E	F	G	H	I													
lavabo 105	1050	495	220	1010	330	200	280	170	170													
 <table border="1" data-bbox="343 2077 827 2128"> <thead> <tr> <th>SOPHIE</th> <th>A</th> <th>B</th> <th>C</th> <th>D</th> <th>E</th> <th>F</th> <th>G</th> <th>H</th> <th>I</th> </tr> </thead> <tbody> <tr> <td>lavabo 120</td> <td>1200</td> <td>500</td> <td>215</td> <td>1155</td> <td>330</td> <td>210</td> <td>280</td> <td>185</td> <td>185</td> </tr> </tbody> </table>	SOPHIE	A	B	C	D	E	F	G	H	I	lavabo 120	1200	500	215	1155	330	210	280	185	185	<b>46119</b> UMIVAONIK SOPHIE 120 cm          <b>46125</b> DRŽAČ RUČNIKA 120 cm          <b>46121</b> NOSAČ UMIVAONIKA	ART.Y0HE          ART.Y0PR          ART.Y0PV
SOPHIE	A	B	C	D	E	F	G	H	I													
lavabo 120	1200	500	215	1155	330	210	280	185	185													



*hatria*

PIATTI DOCCIA





SHOWER TRAYS



	<b>46081</b>	TUŠ KADA HATRIA SA SIFONOM 800x800 mm  ART.BI. Y0Y6
	<b>46082</b>	TUŠ KADA HATRIA SA SIFONOM 730x910 mm  ART.BI. Y0Y8
	<b>46083</b>	TUŠ KADA HATRIA SA SIFONOM POLUKRUŽNA 900x900 mm ART.BI. Y0GF
	<b>46084</b>	TUŠ KADA HATRIA SA SIFONOM POLUKRUŽNA 800x800 mm ART.BI. Y0GE
	OVAJ SIFON JE UKLJUČEN U CIJENU TUŠ KADA ART.Y0GY	

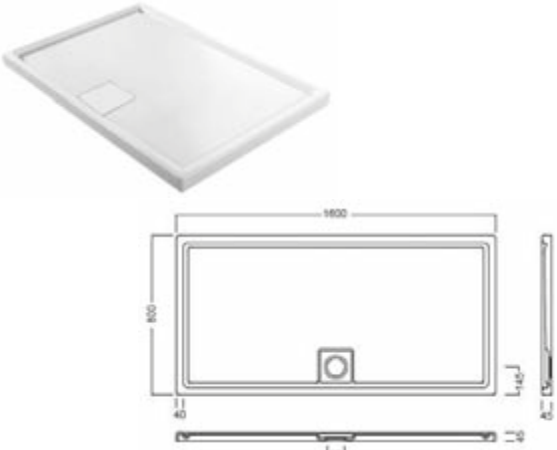

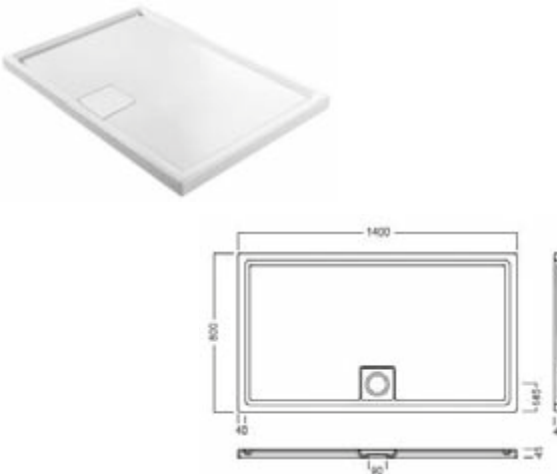
*hatria*

	<p><b>1148008</b></p>	<p>TUŠ KADA HATRIA HEAVYCRIL 1600x800 mm</p> <p>ART.BI. YXEX</p>
	<p><b>1148005</b></p>	<p>TUŠ KADA HATRIA HEAVYCRIL 1500x800 mm</p> <p>ART.BI. YXF2</p>
	<p><b>1148004</b></p>	<p>TUŠ KADA HATRIA HEAVYCRIL 1400x800 mm</p> <p>ART.BI. YXEZ</p>
	<p><b>1148009</b></p>	<p>SIFON Ø 90 mm SQUARE WHITE COVER H = 60 mm</p> <p>ART.BI. Y1D5</p>
	<p><b>1148003</b></p>	<p>SIFON Ø 90 mm SQUARE WHITE COVER H = 75 mm</p> <p>ART.BI. YXEV</p>

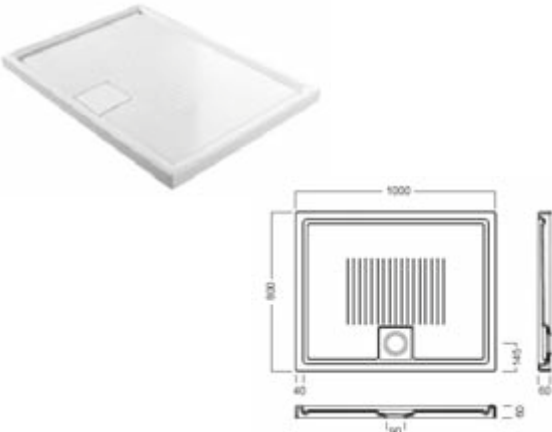
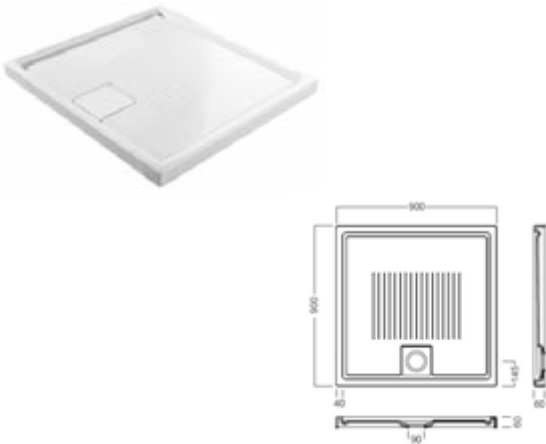
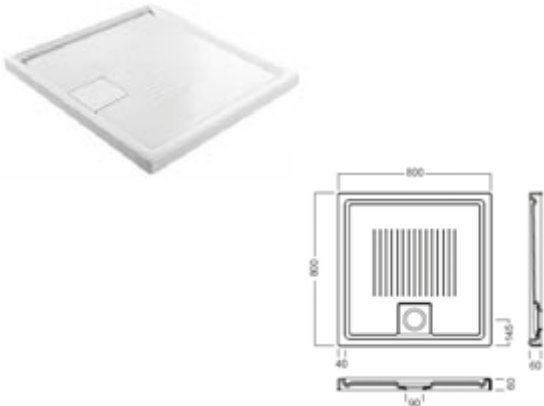
	<p><b>1148001</b></p>	<p>TUŠ KADA HATRIA 1200x800 mm</p> <p>ART.BI. YXE8</p>
	<p><b>1148006</b></p>	<p>TUŠ KADA HATRIA 1000x800 mm</p> <p>ART.BI. YXE7</p>
	<p><b>1148002</b></p>	<p>TUŠ KADA HATRIA 900x900 mm</p> <p>ART.BI. YXE6</p>
	<p><b>1148007</b></p>	<p>TUŠ KADA HATRIA 800x800 mm</p> <p>ART.BI. YXEK</p>



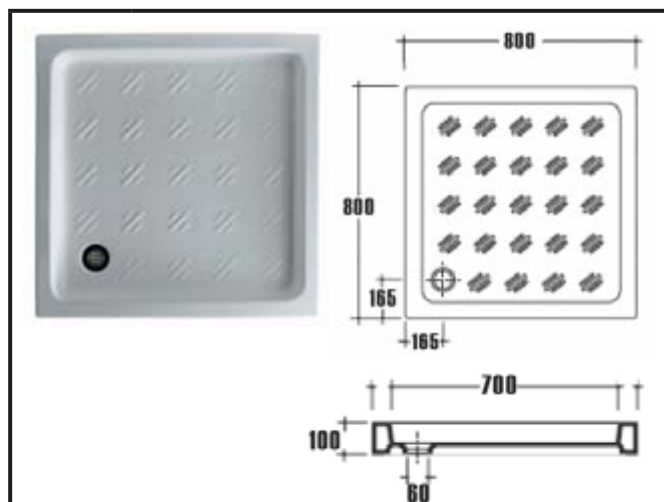

Š.Vokel	Opis
<b>1153005</b>	TUŠ KADA KERAMIČKA 80x80 H=10 ART.1002

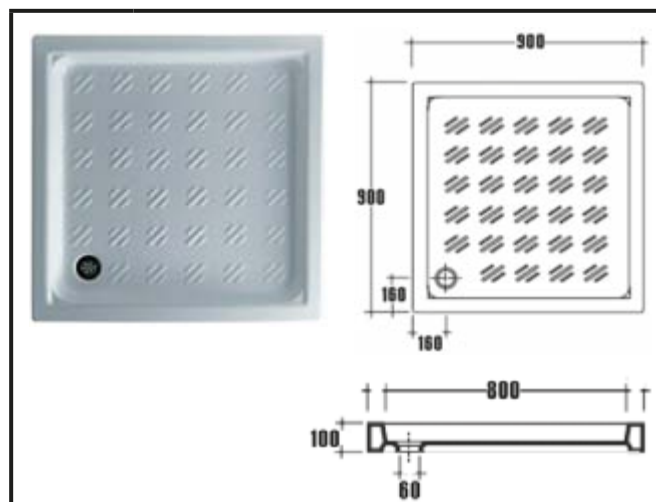

Š.Vokel	Opis
<b>1153006</b>	TUŠ KADA KERAMIČKA 90x90 H=10 ART.1008

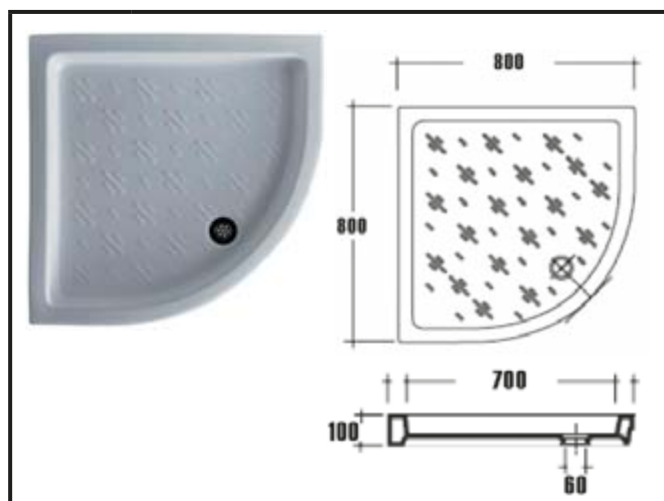

Š.Vokel	Opis
<b>1153007</b>	TUŠ KADA KERAMIČKA 80x80 H=10 ART.1004

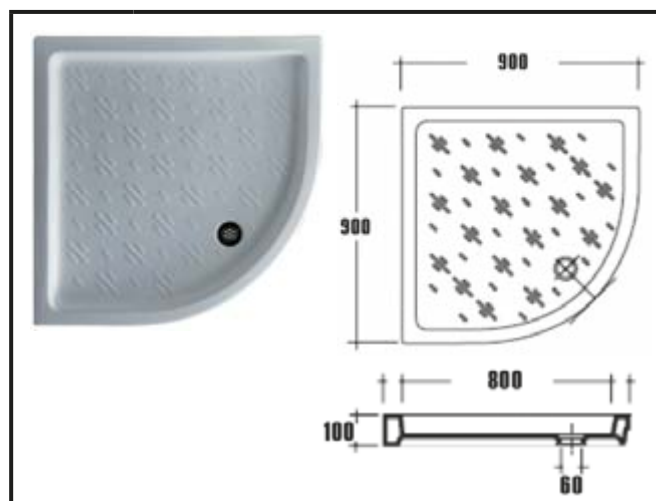

Š.Vokel	Opis
<b>1153008</b>	TUŠ KADA KERAMIČKA 90x90 H=10 ART.1009

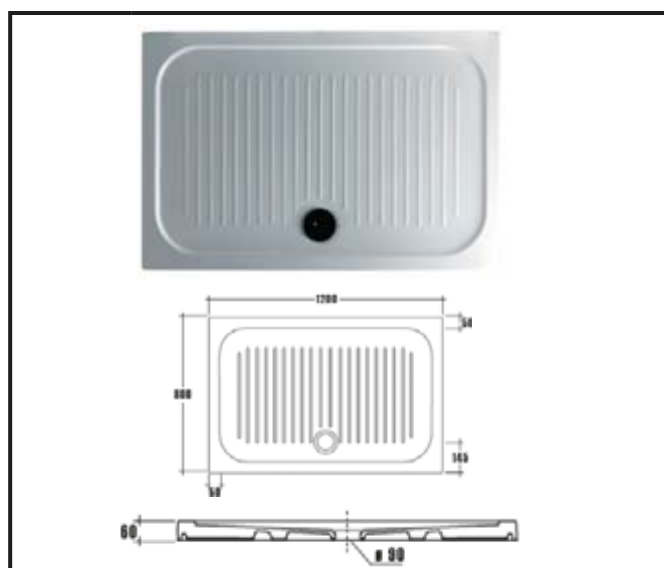

Š.Vokel	Opis
<b>1153009</b>	TUŠ KADA KERAMIČKA 80x120 H=6 ART.1024

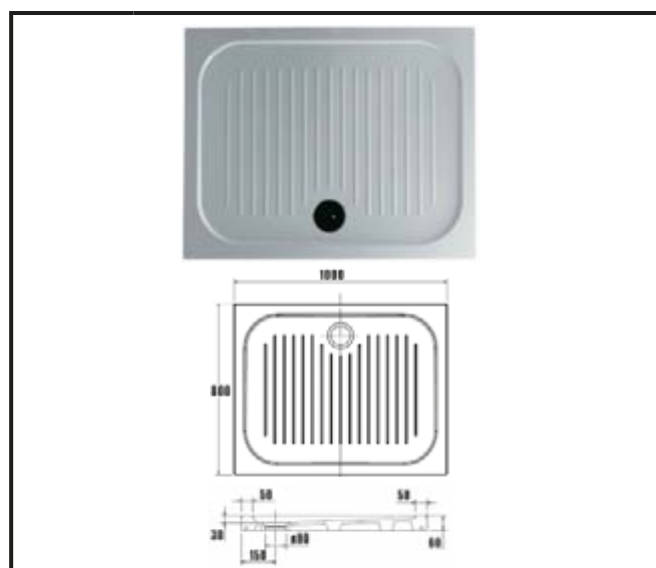

Š.Vokel	Opis
<b>1153010</b>	TUŠ KADA KERAMIČKA 80x100 H=6 ART.1026

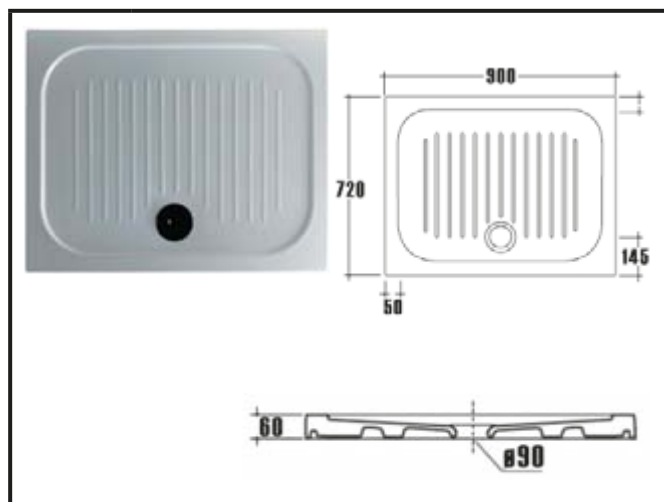

Š.Vokel	Opis
1153011	TUŠ KADA KERAMIČKA 72x90 H=6 ART.1021

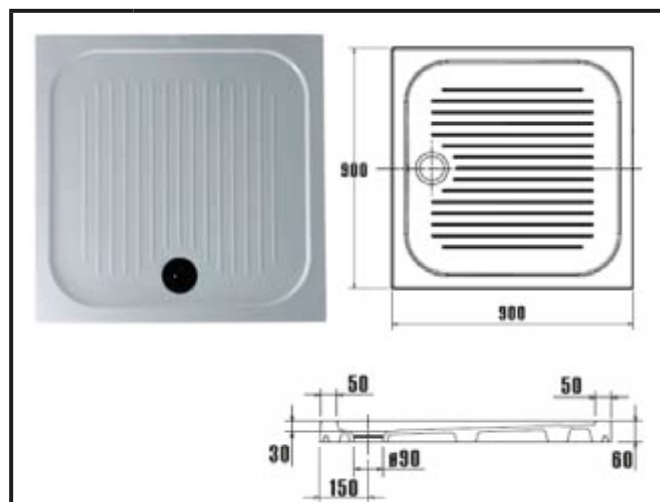

Š.Vokel	Opis
1153012	TUŠ KADA KERAMIČKA 90x90 H=6 ART.1027

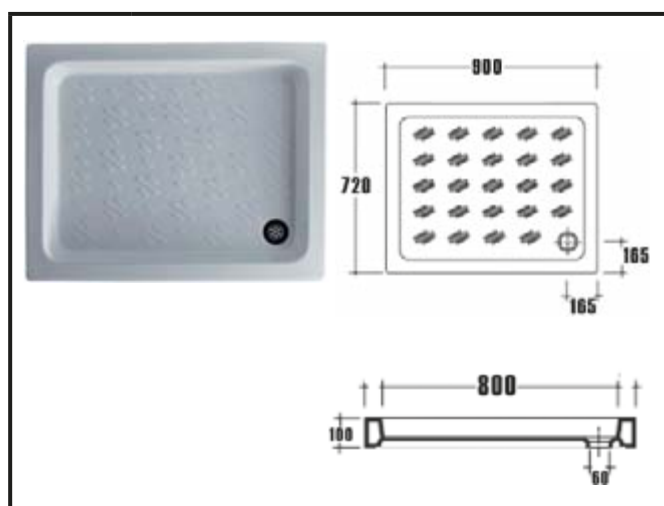

Š.Vokel	Opis
1153013	TUŠ KADA KERAMIČKA 90x72 H=10 ART.1006

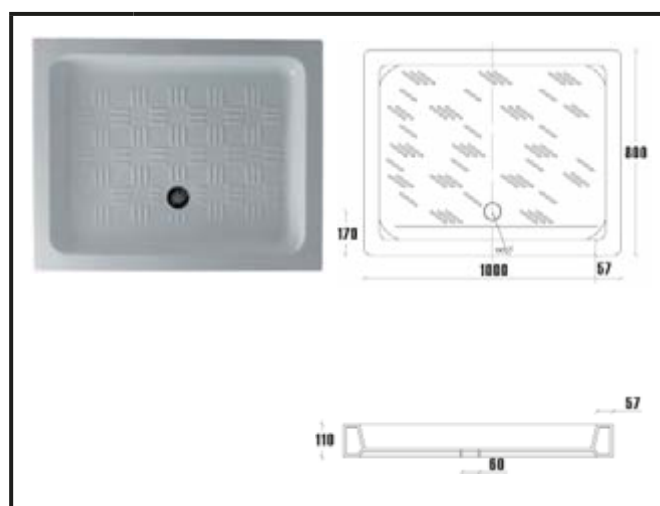

Š.Vokel	Opis
1153014	TUŠ KADA KERAMIČKA 100x80 H=10 ART.1019

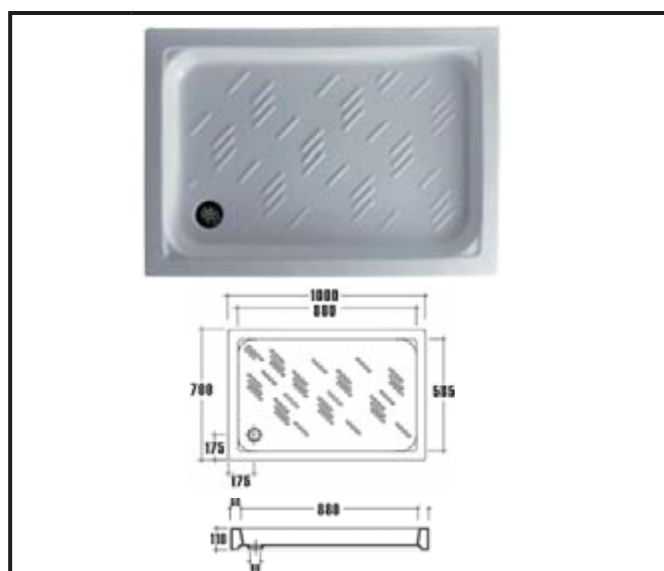

Š.Vokel	Opis
1153015	TUŠ KADA KERAMIČKA 70x100 H=11 ART.1016

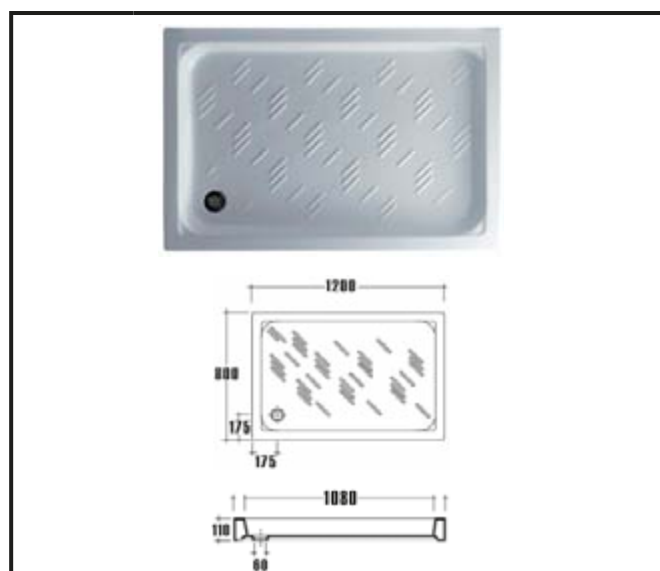

Š.Vokel	Opis
1153016	TUŠ KADA KERAMIČKA 80x120 H=11 ART.1012



# LAUFEN

Bathroom Culture since 1892  [www.laufen.com](http://www.laufen.com)

## IL BAGNO ALESSI



		<p><b>1104001</b></p>	<p>UMIVAONIK ALESSI 52X53 cm ART. 8.1197.1.400.104.1</p>
		<p><b>1104002</b></p>	<p>WC ŠKOLJKA VISEĆA ALESSI ART. 8.2097.6.400.000.1</p>
		<p><b>1104004</b></p>	<p>BIDE VISEĆI ALESSI ART. 8.3097.1.400.304.1</p>
		<p><b>1104005</b></p>	<p>PISOAR SA POKROVOM PISOARA ALESSI ART. 8.4097.1.400.416.1</p>
		<p><b>1104044</b></p>	<p>SIFON ZA PISOAR ART. 8.9497.4.000.000.1</p>



# LAUFEN







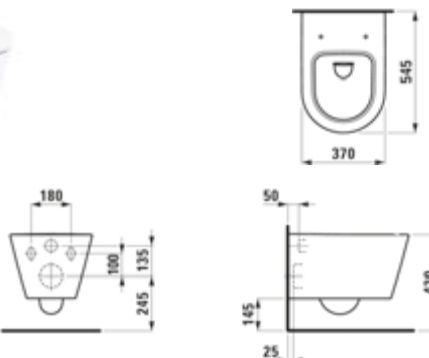

Bathroom Culture since 1892  [www.laufen.com](http://www.laufen.com)

## PALOMBA

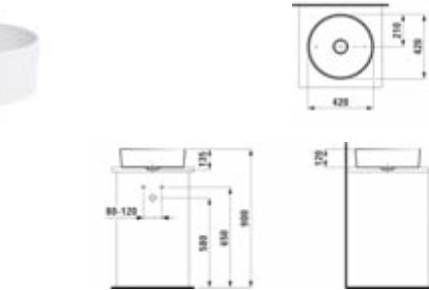



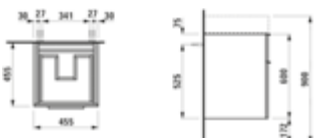

	<p><b>1104012</b></p>	<p>UMIVAONIK PALOMBA 160X50 cm ART. 8.1480.8.000.104.1</p>
	<p><b>1104052</b></p>	<p>UMIVAONIK PALOMBA 50x44cm ART. 8.1780.1.000.105.1</p>
	<p><b>1104054</b></p>	<p>PLOČA BIJELA ZA UMIVAONIK ZDJELU ART.4.0680.0.180.220.1</p>
	<p><b>1104055</b></p>	<p>UMIVAONIK PALOMBA 52x38cm ART. 8.1680.2.000.112.1</p>
	<p><b>1104048</b></p>	<p>WC ŠKOLJKA VISEĆA PALOMBA ART. 8.2080.1.000.000.1</p>
	<p><b>1104045</b></p>	<p>WC DASKA PALOMBA ART. 8.9180.2.000.000.1</p>
	<p><b>1104047</b></p>	<p>BIDE VISEĆI PALOMBA ART. 8.3080.1.000.304.1</p>

 	<b>1104056</b>	WC ŠKOLJKA VISEĆA KARTELL ART. 8.2033.1.000.000.1
 	<b>1104057</b>	WC DASKA SOFT-CLOSE KARTELL ART. 8.9133.1.000.000.1
	<b>1104058</b>	UMIVAONIK KARTELL 42x42cm ART. 8.1233.1.000.112.1
 	<b>1104059</b>	OGLEDALO KARTELL TRANSPARENT CRYSTAL ART. 3.8633.1.084.000.1
 	<b>1104060</b>	UMIVAONIK KARTELL 46x46cm ART. 8.1533.1.000.104.1
 	<b>1104061</b>	ORMARIĆ S LADICOM KARTELL ART. 4.0750.2.033.631.1

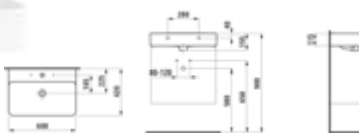
**VAL & INO**

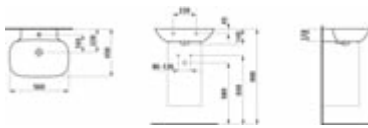
 	<b>1104062</b>	UMIVAONIK VAL 60x42 cm ART. 8.1028.3.000.104.1
 	<b>1104063</b>	UMIVAONIK INO 56x45 cm ART. 8.1030.2.000.104.1



# LAUFEN

Bathroom Culture since 1892  [www.laufen.com](http://www.laufen.com)

## LAUFEN PRO



	<p><b>1104064</b></p>	<p>UMIVAONIK PRO S 60x46,5 cm ART.8.1096.3.000.104.1</p>
	<p><b>1104065</b></p>	<p>UMIVAONIK PRO S 65x46,5 cm ART. 8.1096.4.000.104.1</p>
	<p><b>1104042</b></p>	<p>UMIVAONIK PRO A 60x48 cm ART. 8.1895.2.000.104.1</p>
	<p><b>1104023</b></p>	<p>UMIVAONIK PRO A 65x48 cm ART. 8.1895.3.000.104.1</p>
	<p><b>1104024</b></p>	<p>MASKA PRO ART. 8.1995.1.000.000.1</p>
	<p><b>1104050</b></p>	<p>WC ŠKOLJKA VISEĆA PRO NEW ART. 8.2095.6.000.000.1</p>
	<p><b>1104070</b></p>	<p>WC ŠKOLJKA VISEĆA PRO NEW S HIGIJENSKIM ISPIRAČEM ART. 8.2095.6.000.230.1</p>
	<p><b>1104049</b></p>	<p>WC DASKA PRO UNIVERZALNA SOFT-CLOSE ART. 8.9395.6.300.000.1</p>
	<p><b>1104066</b></p>	<p>WC DASKA PRO SLIM SOFT-CLOSE ART. 8.9896.6.000.000.1</p>
	<p><b>1104051</b></p>	<p>BIDE VISEĆI PRO NEW ART. 8.3095.2.000.302.1</p>

	<p><b>1104067</b></p>	<p>ORMARIĆ S UMIVAONIKOM PRO S 60x40cm ART. 8.6096.1.463.104.1</p>
	<p><b>1104068</b></p>	<p>WC ŠKOLJKA VISEĆA PRO S ART. 8.2096.1.000.000.1</p>
	<p><b>1104069</b></p>	<p>WC DASKA PRO S SOFT CLOSE ART. 8.9196.1.000.000.1</p>
	<p><b>1104025</b>  <b>1104029</b>  <b>1104033</b></p>	<p>WC ŠKOLJKA VISEĆA PRO ART. 8.2095.0.000.000.1</p> <p>WC DASKA PRO ART. 8.9295.1.000.000.1</p> <p>WC DASKA PRO SOFT-CLOSE ART. 8.9195.1.300.000.1</p>
	<p><b>1104026</b></p>	<p>BIDE VISEĆI PRO ART. 8.3095.1.000.304.1</p>
	<p><b>1104031</b>  <b>1104029</b>  <b>1104033</b></p>	<p>WC ŠKOLJKA UNIVERZALNA STOJEĆA PRO ART.8.2295.1.000.000.1</p> <p>WC DASKA PRO ART.8.9295.1.000.000.1</p> <p>WC DASKA SOFT-CLOSE ART.8.9195.1.300.000.1</p>



	<p><b>1104032</b></p>	<p>BIDE STOJEĆI PRO</p> <p>ART. 8.3295.1.000.304.1</p>
	<p><b>1104027</b></p> <p><b>1104028</b></p> <p><b>1104030</b></p> <p><b>1104029</b></p> <p><b>1104033</b></p>	<p>WC ŠKOLJKA PRO MONOBLOK, ODVOD U ZID ART. 8.2495.6.000.000.1</p> <p>WC ŠKOLJKA PRO MONOBLOK, ODVOD U POD ART. 8.2495.7.000.000.1</p> <p>VODOKOTLIĆ PRO ART. 8.2695.0.000.278.1</p> <p>WC DASKA PRO ART. 8.9295.1.000.000.1</p> <p>WC DASKA PRO SOFT-CLOSE ART. 8.9195.1.300.000.1</p>
	<p><b>1104021</b></p> <p><b>1104022</b></p>	<p>PISOAR CASA ART. 8.4014.1.000.000.1</p> <p>POKROV PISOARA CASA ART. 8.9414.1.000.000.1</p>



# EVOLUTION TODAY & TOMORROW



	<p><b>1109001</b></p>	<p>UMIVAONIK KALAHARI 65 cm ART.327874000</p>
	<p><b>1109002</b>  <b>1109003</b></p>	<p>WC ŠKOLJKA VISEĆA SENSO COMPACTO ART.346517000</p> <p>DASKA ZA WC ŠKOLJKU SENSO COMPACTO ART.801511004</p>
	<p><b>1109004</b></p>	<p>BIDE VISEĆI SENSO COMPACTO ART.357515000</p>

## CHIC

	<p><b>1109150</b></p>	<p>PISOAR CHIC SA STRAŽNJIM SKRIVENIM DOVODOM VODE ART.35945J000</p>
	<p><b>1109151</b></p>	<p>PISOAR CHIC SA DOVODOM VODE ODOZGORA ART.35945L000</p>





	<b>1109014</b>	UMIVAONIK DAMA SENSO 48 cm SA MASKOM	ART.327514000																
<table border="1" data-bbox="515 606 707 725"> <thead> <tr> <th>A</th> <th>B</th> <th>C</th> <th>D</th> </tr> </thead> <tbody> <tr> <td>650</td> <td>530</td> <td>590</td> <td>365</td> </tr> <tr> <td>580</td> <td>460</td> <td>520</td> <td>285</td> </tr> <tr> <td>550</td> <td>420</td> <td>490</td> <td>255</td> </tr> </tbody> </table>	A	B	C	D	650	530	590	365	580	460	520	285	550	420	490	255	<b>1109013</b>          <b>1109012</b>          <b>1109010</b>          <b>1109015</b>          <b>1109011</b>	UMIVAONIK DAMA SENSO 55 cm           UMIVAONIK DAMA SENSO 58 cm           UMIVAONIK DAMA SENSO 65 cm           STALAK DAMA SENSO           MASKA ZA UMIVAONIK DAMA SENSO	ART.325513000           ART.325512000           ART.325511000           ART.335510000           ART.337511000
A	B	C	D																
650	530	590	365																
580	460	520	285																
550	420	490	255																
	<b>1109007</b>                      <b>1109003</b>	WC ŠKOLJKA MONOBLOK DAMA SENSO           VODOKOTLIĆ MONOBLOK DAMA SENSO           WC DASKA SPOROSPUŠTAJUĆA           DASKA ZA WC ŠKOLJKU	ART.342519000           ART.341516000           ART.801512004           ART.801511004																
	<b>1109016</b>                      <b>1109098</b>	WC ŠKOLJKA DAMA SENSO           WC DASKA SPOROSPUŠTAJUĆA	ART.347517000           ART.801512004																
	<b>1109009</b>                      <b>1109006</b>	BIDE DAMA SENSO           POKLOPAC ZA BIDE DAMA SENSO	ART.355517000           ART.806510004																

	<p><b>1109022</b></p>	<p>UGRADBENI UMIVAONIK HALL 520x440x92 mm</p>	<p>ART.327882000</p>
	<p><b>1109048</b></p>	<p>UMIVAONIK HALL 650x420x145 mm</p>	<p>ART.327620000</p>
	<p><b>1109113</b></p>	<p>UMIVAONIK HALL 550x485x140mm</p>	<p>ART.327881000</p>



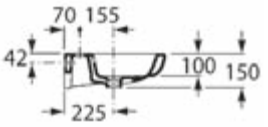

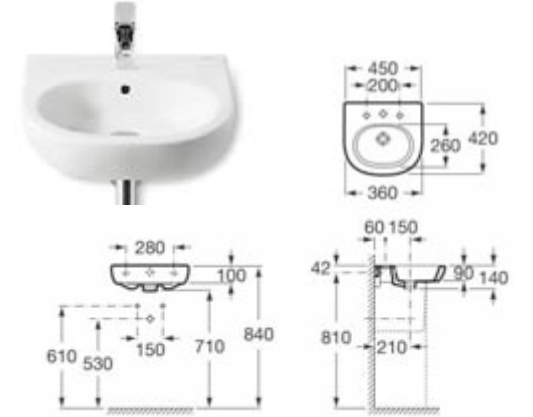
 	<p><b>1109017</b> WC ŠKOLJKA MONOBLOK HALL DVOJNI ODVOD</p>	<p>ART.342628000</p>
 	<p><b>1109018</b> VODOKOTLIČ MONOBLOK HALL</p>	<p>ART.341620000</p>
 	<p><b>1109023</b> WC DASKA HALL</p>	<p>ART.801620004</p>
 	<p><b>1109024</b> WC DASKA HALL SPOROSPUŠTAJUĆA</p>	<p>ART.801622004</p>
 	<p><b>1109025</b> BIDE HALL</p>	<p>ART.357624000</p>
 	<p><b>1109021</b> POKLOPAC ZA BIDE HALL</p>	<p>ART.806620004</p>
 	<p><b>1109020</b> WC ŠKOLJKA VISEĆA HALL</p>	<p>ART.346627000</p>
 	<p><b>1109023</b> WC DASKA HALL</p>	<p>ART.801620004</p>
 	<p><b>1109024</b> WC DASKA HALL SPOROSPUŠTAJUĆA</p>	<p>ART.801622004</p>
 	<p><b>1109019</b> BIDE VISEĆI HALL</p>	<p>ART.357625000</p>
 	<p><b>1109021</b> POKLOPAC ZA BIDE HALL</p>	<p>ART.806620004</p>

 <table border="1" data-bbox="231 608 379 769"> <thead> <tr> <th>A</th> <th>B</th> <th>C</th> </tr> </thead> <tbody> <tr> <td>650</td> <td>550</td> <td>160</td> </tr> <tr> <td>600</td> <td>500</td> <td>160</td> </tr> <tr> <td>550</td> <td>450</td> <td>145</td> </tr> <tr> <td>500</td> <td>400</td> <td>140</td> </tr> </tbody> </table> 	A	B	C	650	550	160	600	500	160	550	450	145	500	400	140	<p><b>1109087</b> UMIVAONIK 55 x 46 MERIDIAN</p> <p><b>1109093</b> UMIVAONIK 65 x 46 MERIDIAN</p> <p><b>1109088</b> MASKA MERIDIAN</p>	<p>ART.327243000</p> <p>ART.327241000</p> <p>ART.337241000</p>
A	B	C															
650	550	160															
600	500	160															
550	450	145															
500	400	140															
	<p><b>1109094</b> UMIVAONIK 70x46 MERIDIAN</p>	<p>ART.327240000</p>															
	<p><b>1109115</b> UMIVAONIK 45x42 MERIDIAN</p>	<p>ART.327245000</p>															
	<p><b>1109130</b> UMIVAONIK MERIDIAN 35x32 COMPACT</p>	<p>ART.327249000</p>															

	<b>1109096</b>	WC MONOBLOK MERIDIAN COMPACT DVOJNI ODVOD ART.342248000
	<b>1109091</b>	WC ŠKOLJKA STOJEĆA MERIDIAN ART.347247000
	<b>1109092</b>	WC DASKA SPOROSPUŠTAJUĆA MERIDIAN ART.8012A2004
	<b>1109117</b>	WC ŠKOLJKA VISEĆA MERIDIAN ART.346247000
	<b>1109132</b>	BIDE VISEĆI MERIDIAN ART.357245000
	<b>1109099</b>	POKLOPAC ZA BIDE SPOROSPUŠTAJUĆI MERIDIAN ART.8062A2004

	<b>1109109</b>	BIDE STOJEČÍ MERIDIAN COMPACT	ART.357247000
	<b>1109085</b>	WC ŠKOLJKA VISEČÁ MERIDIAN COMPACT	ART.346248000
	<b>1109086</b>	BIDE VISEČÍ MERIDIAN COMPACT	ART.357246000
	<b>1109090</b>	POKLOPAC ZA BIDE SPOROSPUŠTAJUČÍ MERIDIAN COMPACT	ART.8062AC004

	<b>1109051</b>	UMIVAONIK NEXO 90 cm S POLICOM LIJEVI	ART.327649000
	<b>1109069</b>	UMIVAONIK NEXO 90 cm S POLICOM DESNI	ART.327648000
	<b>1109050</b>	UMIVAONIK NEXO 60 cm	ART.327641000
	<b>1109068</b>	UMIVAONIK NEXO 68 cm	ART.327640000
	<b>1109052</b>	MASKA NEXO ZA UMIVAONIK	ART.337642000
	<b>1109074</b>	UMIVAONIK KUTNI NEXO 54x50	ART.327646000
	<b>1109053</b>	WC ŠKOLJKA NEXO MONOBLOK KRATKA	ART.342642000
	<b>1109054</b>	VODOKOTLIČ MONOBLOK SA MEHANIZMOM NEXO	ART.341642000
	<b>1109058</b>	WC DASKA SPOROSPUŠTAJUĆA NEXO	ART.80164A004
	<b>1109114</b>	WC DASKA NEXO	ART.801640004













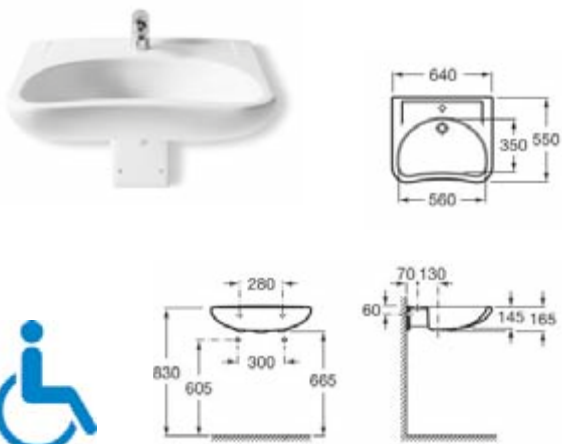



	<p><b>1109056</b></p>	<p>BIDE STOJEĆI NEXO</p>	<p>ART.357640000</p>
	<p><b>1109055</b></p>	<p>WC ŠKOLJKA NEXO VISEĆA</p>	<p>ART.346640000</p>
	<p><b>1109057</b></p>	<p>BIDE NEXO VISEĆI</p>	<p>ART.357645000</p>









	<p><b>1109123</b></p>	<p>UMIVAONIK 660mm TIPO</p>	<p>ART.327750000</p>
	<p><b>1109124</b></p>	<p>MASKA ZA UMIVAONIK TIPO</p>	<p>ART.337750000</p>
	<p><b>1109125</b></p>	<p>WC ŠKOLJKA VISEĆA TIPO</p>	<p>ART.346757000EU</p>
	<p><b>1109126</b></p>	<p>WC DASKA TIPO</p>	<p>ART.801750004</p>
	<p><b>1109127</b></p>	<p>WC DASKA SPOROSPUŠTAJUĆA</p>	<p>ART.801752004</p>
	<p><b>1109128</b></p>	<p>VISEĆI BIDE TIPO</p>	<p>ART.RT357755000</p>
	<p><b>1109129</b></p>	<p>STOJEĆI BIDE TIPO</p>	<p>ART.357757000</p>



 <p>Technical drawings of a white pedestal sink. The main drawing shows a top view with dimensions: width 640 mm, depth 560 mm, and a central basin width of 350 mm and depth of 550 mm. A side view shows a height of 830 mm. A smaller side view shows a depth of 280 mm and a basin width of 300 mm. A detailed side view shows a mounting hole diameter of 70 mm, a total height of 130 mm, and a basin depth of 145 mm and 165 mm.</p> 	<p><b>1109135</b></p>	<p>UMIVAONIK 640 mm ACCESS</p> <p>ART.327230000</p>
 <p>Technical drawings of a white wall-hung toilet. The main drawing shows a top view with dimensions: width 360 mm, depth 700 mm, and a bowl width of 155 mm and depth of 430 mm. A side view shows a height of 480 mm. A smaller side view shows a bowl width of 180 mm, a depth of 100 mm, and a total height of 380 mm. A detailed side view shows a mounting hole diameter of 102 mm, a bowl width of 205 mm, and a depth of 120 mm and 15 mm.</p> 	<p><b>1109133</b></p>	<p>WC ŠKOLJKA VISEĆA ACCESS</p> <p>ART.346237000</p>
 <p>Technical drawings of a white floor-standing toilet. The main drawing shows a top view with dimensions: width 380 mm, depth 670 mm, and a bowl width of 155 mm and depth of 430 mm. A side view shows a height of 865 mm. A smaller side view shows a bowl width of 180 mm, a depth of 100 mm, and a total height of 380 mm. A detailed side view shows a mounting hole diameter of 102 mm, a bowl width of 205 mm, and a depth of 120 mm and 15 mm.</p> 	<p><b>1109146</b></p>	<p>WC ŠKOLJKA ACCESS MONOBLOK ODVOD U ZID</p> <p>ART.342236000</p>
 <p>Technical drawings of a white floor-standing toilet. The main drawing shows a top view with dimensions: width 380 mm, depth 670 mm, and a bowl width of 155 mm and depth of 430 mm. A side view shows a height of 815 mm. A smaller side view shows a bowl width of 180 mm, a depth of 100 mm, and a total height of 380 mm. A detailed side view shows a mounting hole diameter of 102 mm, a bowl width of 205 mm, and a depth of 120 mm and 15 mm.</p> 	<p><b>1109149</b></p>	<p>VODOKOTLIĆ ACCESS S DVOJNIM ISPIRANJEM 6/3L BOČNI DOVOD VODE</p> <p>ART.341230000</p>
 <p>Technical drawings of a white floor-standing toilet. The main drawing shows a top view with dimensions: width 380 mm, depth 670 mm, and a bowl width of 155 mm and depth of 430 mm. A side view shows a height of 815 mm. A smaller side view shows a bowl width of 180 mm, a depth of 100 mm, and a total height of 380 mm. A detailed side view shows a mounting hole diameter of 102 mm, a bowl width of 205 mm, and a depth of 120 mm and 15 mm.</p> 	<p><b>1109147</b></p>	<p>WC ŠKOLJKA ACCESS MONOBLOK ODVOD U POD</p> <p>ART.342237000</p>
 <p>Technical drawings of a white floor-standing toilet. The main drawing shows a top view with dimensions: width 380 mm, depth 670 mm, and a bowl width of 155 mm and depth of 430 mm. A side view shows a height of 815 mm. A smaller side view shows a bowl width of 180 mm, a depth of 100 mm, and a total height of 380 mm. A detailed side view shows a mounting hole diameter of 102 mm, a bowl width of 205 mm, and a depth of 120 mm and 15 mm.</p> 	<p><b>1109149</b></p>	<p>VODOKOTLIĆ ACCESS S DVOJNIM ISPIRANJEM 6/3L BOČNI DOVOD VODE</p> <p>ART.341230000</p>
 <p>Technical drawings of a white floor-standing toilet. The main drawing shows a top view with dimensions: width 380 mm, depth 670 mm, and a bowl width of 155 mm and depth of 430 mm. A side view shows a height of 815 mm. A smaller side view shows a bowl width of 180 mm, a depth of 100 mm, and a total height of 380 mm. A detailed side view shows a mounting hole diameter of 102 mm, a bowl width of 205 mm, and a depth of 120 mm and 15 mm.</p> 	<p><b>1109134</b></p>	<p>WC DASKA S POKLOPCEM</p> <p>ART.801230004</p>

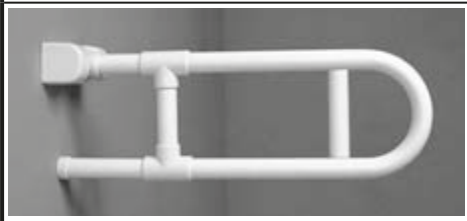
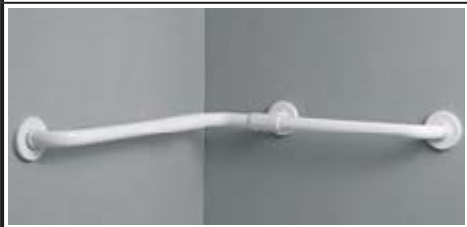

	<p><b>67001</b></p>	<p>RUKOHVAT KUTNI 135°</p> <p>ART.G01JASW108</p>
	<p><b>67002</b></p>	<p>DRŽAČ-OSLONAC SX</p> <p>DIMENZIJE: L=80 CM H=19,5 CM</p> <p>ART.G01JCSW107</p>
	<p><b>67003</b></p>	<p>DRŽAČ S PRIČVRSNICOM I DRŽAČEM WC PAPIRA</p> <p>ART.G01JCSW111</p> <p>DIMENZIJE: L=80 H=19,5</p>
	<p><b>67004</b></p>	<p>RUKOHVAT KUTNI 100X100</p> <p>ART.80220</p> <p><i>NAPOMENA: OVAJ RUKOHVAT MOŽETE NARUČITI PREMA ŽELJENIM DIMENZIJAMA</i></p>
	<p><b>0459025</b></p>	<p>RUKOHVAT RAVNI 50CM</p> <p>ART.G20JASW103</p>
	<p><b>0459021</b></p>	<p>RUKOHVAT RAVNI 60CM</p> <p>ART.G20JASW104</p>
	<p><b>67029</b></p>	<p>RUKOHVAT RAVNI 90CM</p> <p>ART.G20JASW107</p>
	<p><b>67005</b></p>	<p>RUKOHVAT S KONZOLOM I TUŠ RUČICOM DX</p> <p>ART.82980</p>
	<p><b>67015</b></p>	<p>RUKOHVAT S KONZOLOM I TUŠ RUČICOM SX</p> <p>ART.G01J0LW102</p> <p>DIMENZIJE: L=66 CM H= 120 CM</p>

	<p><b>67006</b></p>	<p>OGLEDALO POKRETNO 58X44</p> <p>ART.F41JPSW101</p>
	<p><b>67007</b></p>	<p>LAVABO ERGO 66X57</p> <p>ART.B40CMSW101</p>
	<p><b>67016</b></p>	<p>SIFON ZA UMIVAONIK</p> <p>ART.880101</p>
	<p><b>67008</b></p>	<p>KONZOLA ZA UMIVAONIK ERGO</p> <p>ART.B41DASW105</p>
	<p><b>67010</b></p>	<p>SJEDALICA NOSIVOST 150KG</p> <p>ART.G01JDSW111</p> <p>DIMENZIJE: SJEDALICA 35X35 H=61 CM</p>



	<b>67013</b>	WC ŠKOLJKA UNIVERZALNA OLDER	ART.B40CBOW103
	<b>0459026</b>	WC ŠKOLJKA PODNA ERGO	ART.B40BCOW101
	<b>67034</b>	WC ŠKOLJKA VISEČA OLDER	ART.B40CAOW101
	<b>67014</b>	WC POKLOPAC OLDER	ART.B41DEOW107
	<b>0459027</b>	WC POKLOPAC ERGO	ART.B41DEOW104
	<b>67009</b>	TUŠ KADA UGRADNA ZERO 90X90 SA SIFONOM	ART.871112 ART.900159
	<b>67030</b>	SIFON ZA TUŠ KADU	ART.H52HASN103
	<b>67020</b>	FIKSNA KONZOLA ZA UMIVAONIK "ERGO"	ART.DCSW101

	<p><b>1161001</b></p> <p><b>1161002</b></p> <p><b>1161003</b></p> <p><b>1161004</b></p> <p><b>1161005</b></p>	<p>RUKOHVAT RAVNI HELP 40 cm BIJELI</p> <p>RUKOHVAT RAVNI HELP 50 cm BIJELI</p> <p>RUKOHVAT RAVNI HELP 60 cm BIJELI</p> <p>RUKOHVAT RAVNI HELP 70 cm BIJELI</p> <p>RUKOHVAT RAVNI HELP 80 cm BIJELI</p>	<p>ART.301100404</p> <p>ART.301100504</p> <p>ART.301100604</p> <p>ART.301100704</p> <p>ART.301100804</p>
	<p><b>1161006</b></p>	<p>OSLONAC U-OBLIK HELP 813 mm BIJELI</p>	<p>ART.301102064</p>
	<p><b>1161007</b></p>	<p>OSLONAC U-OBLIK NA SKLAPANJE HELP 813 mm BIJELI</p>	<p>ART.301102084</p>
	<p><b>1161008</b></p>	<p>OSLONAC U-OBLIK NA SKLAPANJE S DRŽAČEM WC PAPIRA HELP 813 mm BIJELI</p>	<p>ART.301102284</p>
	<p><b>1161009</b></p>	<p>RUKOHVAT KUTNI 120° HELP BIJELI</p>	<p>ART.301102014</p>
	<p><b>1161012</b></p>	<p>RUKOHVAT ZA TUŠ HELP BIJELI</p>	<p>ART.301102034</p>

	<p><b>1161010</b></p>	<p>RUKOHVAT ZA TUŠ S KONZOLOM KUTNI DESNI HELP BIJELI ART.301122024</p>
	<p><b>1161011</b></p>	<p>RUKOHVAT ZA TUŠ S KONZOLOM KUTNI LIJEVI HELP BIJELI ART.301112024</p>
	<p><b>1161013</b></p>	<p>RUKOHVAT ZA TUŠ S KONZOLOM DESNI HELP BIJELI ART.301122044</p>
	<p><b>1161014</b></p>	<p>RUKOHVAT ZA TUŠ S KONZOLOM LIJEVI HELP BIJELI ART.301112044</p>
	<p><b>1161021</b></p>	<p>DRŽAČ TUŠ RUČICE HELP ZA RUKOHVATE S TUŠ KONZOLOM ART.338514372</p>

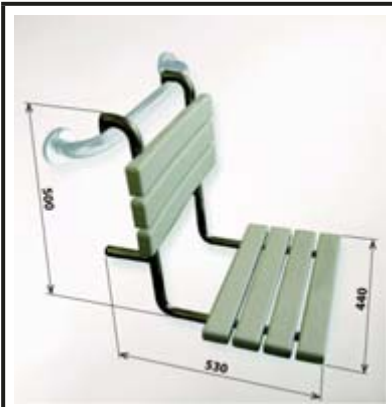
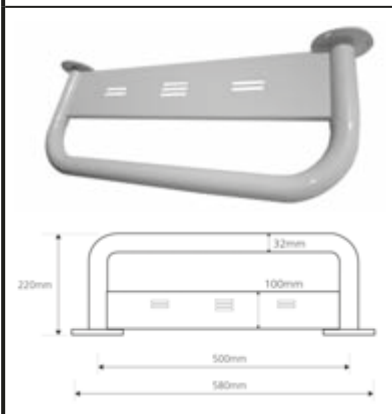

	<p><b>1161015</b></p>	<p>POTPORNI OSOLONAC U-OBLIK DESNI HELP 813 mm BIJELI</p>	<p>ART.301112164</p>
	<p><b>1161016</b></p>	<p>POTPORNI OSOLONAC U-OBLIK LIJEVI HELP 813 mm BIJELI</p>	<p>ART.301112154</p>
	<p><b>1161017</b></p>	<p>SJEDALICA NA SKLAPANJE HELP</p>	<p>ART.326325056</p>
	<p><b>1161018</b></p>	<p>SJEDALICA NA SKLAPANJE S POTPOROM HELP</p>	<p>ART.301102181</p>
	<p><b>1161019</b></p>	<p>SJEDALICA ZA KADU HELP</p>	<p>ART.338125066</p>

 <p>Dimensions: 605 (height), 530 (width), 440 (depth)</p>	<p><b>1161020</b></p>	<p>TUŠ SJEDALICA VISEĆA ZA RUKOHVAT HELP ART.338125081</p>
 <p>Dimensions: 220mm (height), 500mm (width), 580mm (depth), 32mm (width of top bar), 100mm (width of middle bar)</p>	<p><b>1161022</b></p>	<p>POLICA S DRŽAČEM 500x230 mm HELP BIJELO ART.301100574</p>
 <p>Dimensions: 400 (width), 600 (height)</p>	<p><b>1161023</b></p>	<p>POKRETNO OGLEDALO 400x600 HELP BIJELO ART.301401034</p>
 <p>Dimensions: 600 (width), 600 (height)</p>	<p><b>1161024</b></p>	<p>POKRETNO OGLEDALO 600x600 HELP BIJELO ART.301401044</p>



HARO® WC-sjedala ne sadrže tvari koje ugrožavaju okoliš i time nisu štetna za kožu.



HARO® Duroplast-WC-sjedala su otporna na žar cigareta. Provjereno prema DIN 438-2.18.



HARO® Duroplast-WC-sjedala su antistatična i odbijaju prašinu.



HARO® WC-sjedala su otporna na neutralna i u kućanstvima uobičajena sredstva za čišćenje.



HARO® Duroplast-WC-sjedala su otporni na UV-svjetlost. Provjereno prema DIN EN 438-2.18.



HARO® Duroplast-WC-sjedala su jako otporna na opterećenja. Vrijednost mjerenja kod 3,0 N. Provjereno prema DIN EN 438-2.14.



HARO® Duroplast-WC-sjedala su otporna na kemikalije. Provjereno prema DIN EN 438-2.15.

**HAMBERGER®**  
SANITARY DIVISION

Hamberger Industriewerke GmbH  
Postfach 10 03 53 · 83003 Rosenheim · Germany  
www.haro-sanitary.com · sanitary@hamberger.de  
Telefon +49 8031 700-658 · Fax +49 8031 700-661



**HARO®**



## ACTIVE SHIELD i Polygiene™ – Higijena 21. stoljeća

ACTIVE SHIELD aktivni zaštitni štiti HARO®-a, pouzdano sprječava stvaranje i širenje klica i bakterija putem srebrenih iona koji su u plastici asimilirani i pri tome je nježan prema koži i bezmirisan. Time sva sjedala sa ACTIVE SHIELD-om osiguravaju da će i pri uporabi u socijalnim, javnim kao i privatnim objektima moći suvereno izvršiti i natprosječne zahtjeve za higijenom.

Novost kod Hamberger-a je Polygiene: nova pionirska tehnologija tvrtke Perstorp AB – nazvana Polygiene™ – ima antiviralni i antibakterijski svojstva kakvih dosada u takvom proizvodu nije bilo. Polygiene je prvi proizvod koji različite uzročnike bolesti kao i SARS korona virus (SARS-CoV) pri dodira ubija.

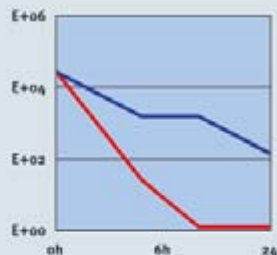

Krivulja preživljavanja salmonela tip 1

■ Standardna masa za oblikovanje  
■ ACTIVE SHIELD

ACTIVE SHIELD

Logarithm (TCID<sub>50</sub>)

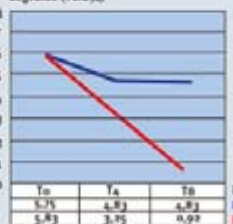

Aktivnost protiv SARS-a  
U različito vrijeme dodira sa SARS virusom Bjo1  
■ K-kontrolni termoplastični spoj  
■ P - polygiene



	<p><b>90400</b></p> <p><b>0479023</b></p>	<p>WC DASKA TERMOPLAST HARO-CORSICA BIJELA</p> <p>WC DASKA HARO-CORSICA SOFTCLOSE BIJELA</p>
	<p><b>90422</b></p> <p><b>0479019</b></p>	<p>WC DASKA DUROPLAST HARO-BALTIC BIJELA</p> <p>WC DASKA TOP FIX HARO-BALTIC S USADNIM VIJCIMA BIJELA</p>
	<p><b>90423</b></p>	<p>WC DASKA DUROPLAST HARO STREAM ZA VALENTINU BIJELA</p>
	<p><b>90444</b></p>	<p>WC DASKA DUROPLAST HARO-SPRING ZA VALENTINU BIJELA</p>
	<p><b>90702</b></p>	<p>WC DASKA DUROPLAST HARO-CARE 15 AS BIJELA</p>
	<p><b>90705</b></p>	<p>WC DASKA TERMOPLAST HARO-BABY COMFORT BIJELA</p>
	<p><b>0479015</b></p>	<p>WC DASKA HARO-COMO BIJELA SA AMORTIZEROM</p>

	<p><b>0479016</b></p>	<p>WC DASKA HARO-PICCO BIJELA</p>
	<p><b>90704</b></p>	<p>WC DASKA TVRDA PLASTIKA HARO-WAVE S AMORTIZERIMA BIJELA</p>
	<p><b>0479022</b></p>	<p>WC DASKA HARO-FLUKE SOFT CLOSE ECO BIJELA</p>
	<p><b>0479021</b></p>	<p>WC DASKA HARO DIAMOND BIJELA</p>
	<p><b>0479020</b></p>	<p>WC DASKA HARO DIAMOND CRNA</p>



	<b>1141001</b>	WC DASKA PVC KAROLINA BIJELA BOJA 840 g ART.3859890074199
	<b>1141004</b>	WC DASKA PVC KAROLINA BEŽ 840 g ART.3859890074212
	<b>1141003</b>	WC DASKA PVC KAROLINA BERMUDA 840 g ART.3859890074205
	<b>1141002</b>	WC DASKA PVC KAROLINA CALYPSO 840 g ART.3859890074229

WC DASKE RAZNO

	<b>05030</b>	WC DASKA PVC MANHETN (SIVA) 800 g
	<b>21125</b>	WC DASKA PVC CALYPSO (ZELENA) 800 g
	<b>0526136</b>	HIGIJENSKA WC DASKA BIDE 2 U 1 AKVASAN

CATS - NERO - CRNO



<b>1168001</b>	120x200cm
<b>1168002</b>	180x200cm
<b>1168003</b>	240x200cm

SAVON - NERO - CRNO



<b>1168004</b>	120x200cm
<b>1168005</b>	180x200cm
<b>1168006</b>	240x200cm

TULIPANI - ROSO - CRVENO



<b>1168007</b>	120x200cm
<b>1168008</b>	180x200cm
<b>1168009</b>	240x200cm

DAKAR - GIALLO - ŽUTO



<b>1168010</b>	120x200cm
<b>1168011</b>	180x200cm
<b>1168012</b>	240x200cm

CONTRASTI - BEIGE - BEŽ



<b>1168013</b>	120x200cm
<b>1168014</b>	180x200cm
<b>1168015</b>	240x200cm

MOSAIC-BEIGE - BEŽ



<b>1168016</b>	120x200cm
<b>1168017</b>	180x200cm
<b>1168018</b>	240x200cm

STELI VERDE ERBA - ZELENO



<b>1168019</b>	120x200cm
<b>1168020</b>	180x200cm
<b>1168021</b>	240x200cm

VIOLA - LILLA - LJUBIČASTO



<b>1168022</b>	120x200cm
<b>1168023</b>	180x200cm
<b>1168024</b>	240x200cm

DAMA - BIANCO - BIJELO



<b>1168025</b>	120x200cm
<b>1168026</b>	180x200cm
<b>1168027</b>	240x200cm

ALFABETO - BIANCO - BIJELO



<b>1168028</b>	120x200cm
<b>1168029</b>	180x200cm
<b>1168030</b>	240x200cm

Q. GHIACCIO - BIJELO



<b>1168031</b>	120x200cm
<b>1168032</b>	180x200cm
<b>1168033</b>	240x200cm

TINTA UNITA - BIJELO



<b>1168034</b>	120x200cm
<b>1168035</b>	180x200cm
<b>1168036</b>	240x200cm



POLUKRUŽNI NOSAČ ZAVJESA

80x80	
BIJELA	KROM
<b>1168038</b>	<b>1168039</b>



RAVNI NOSAČ ZAVJESA

BIJELA		KROM	
60-90			
<b>1168040</b>	<b>1168037</b>		
75-135			
<b>1168041</b>	<b>1168042</b>		
125-220			
<b>1168043</b>	<b>1168044</b>		
155-255			
<b>1168045</b>	<b>1168046</b>		



KUTNI NOSAČ ZAVJESA

BIJELA		KROM	
80x80			
<b>1168047</b>	<b>1168048</b>		
80x170			
<b>1168049</b>	<b>1168050</b>		
80x80x80			
<b>1168051</b>	<b>1168052</b>		
80x170x80			
<b>1168053</b>	<b>1168054</b>		



*Pure Freude an Wasser*

**GROHE**  
~~~~~

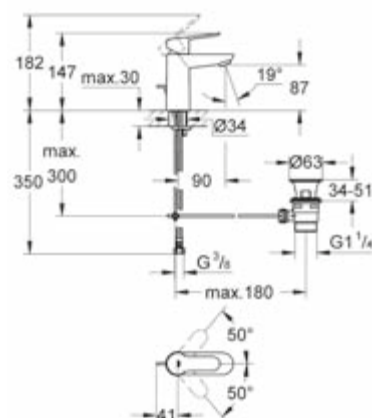

BATERIJA ZA UMIVAONIK

| ŠIFRA VOKEL    | BOJA | ŠIFRA ARTIKLA | PAKIRANJE |
|----------------|------|---------------|-----------|
| <b>0437165</b> | KROM | 23328000      | 1         |

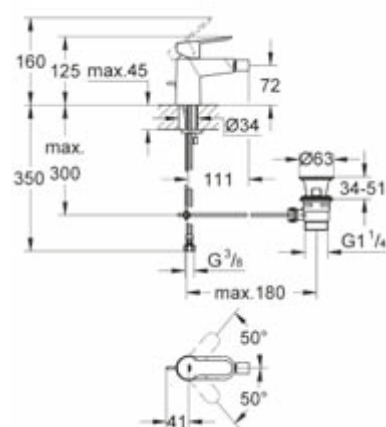

BATERIJA ZA BIDE

| ŠIFRA VOKEL    | BOJA | ŠIFRA ARTIKLA | PAKIRANJE |
|----------------|------|---------------|-----------|
| <b>0437166</b> | KROM | 23331000      | 1         |

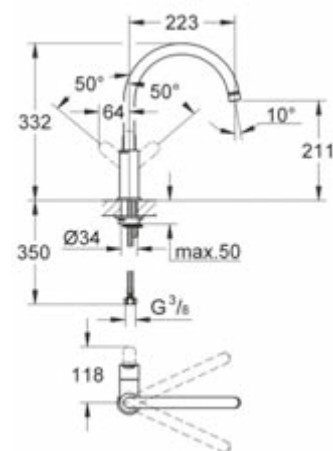

BATERIJA ZA KUHINJU  
SA 2 CIJEVI

| ŠIFRA VOKEL    | BOJA | ŠIFRA ARTIKLA | PAKIRANJE |
|----------------|------|---------------|-----------|
| <b>0437167</b> | KROM | 31367000      | 1         |

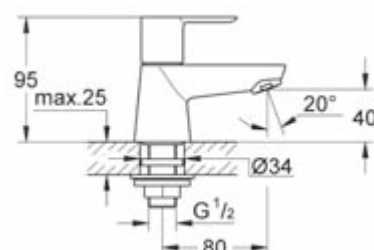

BATERIJA ZA UMIVAONIK  
SAMO HLADNA VODA

| ŠIFRA VOKEL    | BOJA | ŠIFRA ARTIKLA | PAKIRANJE |
|----------------|------|---------------|-----------|
| <b>0437168</b> | KROM | 20421000      | 1         |

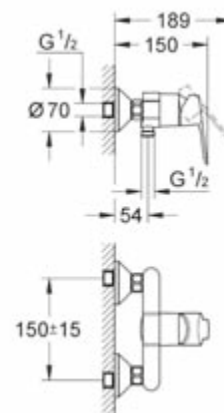

### BATERIJA ZA TUŠ

| ŠIFRA VOKEL    | BOJA | ŠIFRA ARTIKLA | PAKIRANJE |
|----------------|------|---------------|-----------|
| <b>0437169</b> | KROM | 23333000      | 1         |

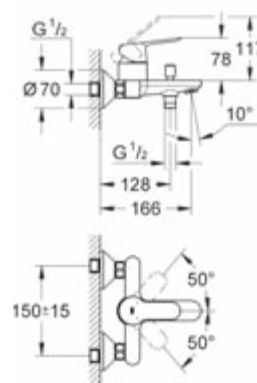

### BATERIJA ZA KADU

| ŠIFRA VOKEL    | BOJA | ŠIFRA ARTIKLA | PAKIRANJE |
|----------------|------|---------------|-----------|
| <b>0437170</b> | KROM | 23334000      | 1         |



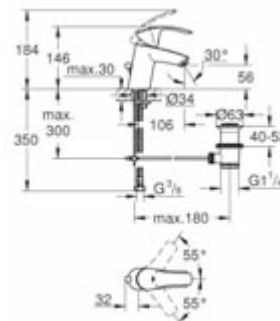

BATERIJA ZA UMIVAONIK

| ŠIFRA VOKEL    | BOJA | ŠIFRA ARTIKLA | PAKIRANJE |
|----------------|------|---------------|-----------|
| <b>0437056</b> | KROM | 33265002      | 1         |

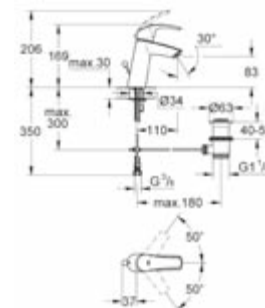

BATERIJA ZA UMIVAONIK XL

| ŠIFRA VOKEL    | BOJA | ŠIFRA ARTIKLA | PAKIRANJE |
|----------------|------|---------------|-----------|
| <b>0437150</b> | KROM | 23322001      | 1         |

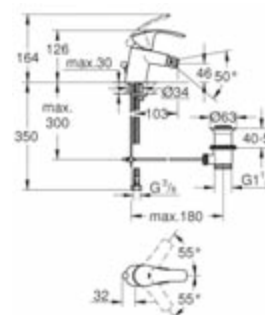

BATERIJA ZA BIDE

| ŠIFRA VOKEL    | BOJA | ŠIFRA ARTIKLA | PAKIRANJE |
|----------------|------|---------------|-----------|
| <b>0437060</b> | KROM | 32929002      | 1         |

BATERIJA ZA KADU  
SA CRIJEVOM I TUŠ RUČICOM

| ŠIFRA VOKEL    | BOJA | ŠIFRA ARTIKLA | PAKIRANJE |
|----------------|------|---------------|-----------|
| <b>0437045</b> | KROM | 33302002      | 1         |

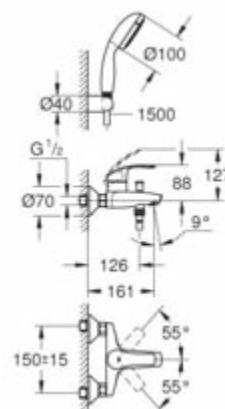

BEZ CRIJEVA I TUŠ RUČICE

| ŠIFRA VOKEL    | BOJA | ŠIFRA ARTIKLA | PAKIRANJE |
|----------------|------|---------------|-----------|
| <b>0437155</b> | KROM | 33300002      | 1         |

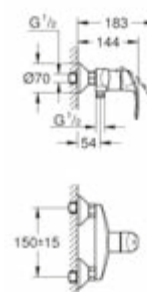

BATERIJA ZA TUŠ

| ŠIFRA VOKEL    | BOJA | ŠIFRA ARTIKLA | PAKIRANJE |
|----------------|------|---------------|-----------|
| <b>0437046</b> | KROM | 33555002      | 1         |

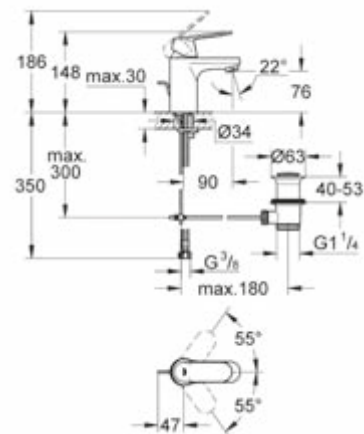

BATERIJA ZA UMIVAONIK

| ŠIFRA VOKEL    | BOJA | ŠIFRA ARTIKLA | PAKIRANJE |
|----------------|------|---------------|-----------|
| <b>0437108</b> | KROM | 32825000      | 1         |

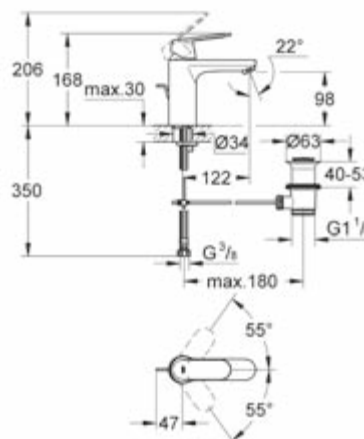

BATERIJA ZA UMIVAONIK XL

| ŠIFRA VOKEL    | BOJA | ŠIFRA ARTIKLA | PAKIRANJE |
|----------------|------|---------------|-----------|
| <b>0437152</b> | KROM | 23325000      | 1         |

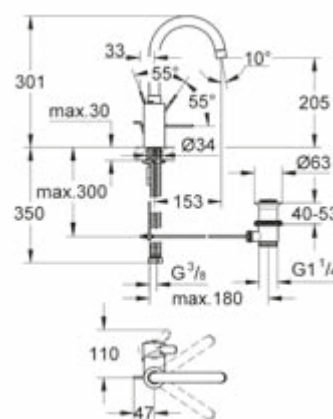

BATERIJA ZA UMIVAONIK-VISOKA

| ŠIFRA VOKEL    | BOJA | ŠIFRA ARTIKLA | PAKIRANJE |
|----------------|------|---------------|-----------|
| <b>0437109</b> | KROM | 32830000      | 1         |

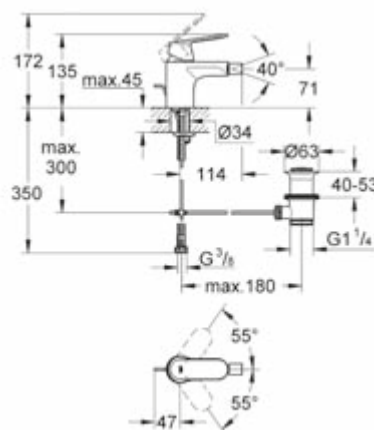

BATERIJA ZA BIDE

| ŠIFRA VOKEL    | BOJA | ŠIFRA ARTIKLA | PAKIRANJE |
|----------------|------|---------------|-----------|
| <b>0437110</b> | KROM | 32839000      | 1         |

BATERIJA ZA KADU  
SA CRIJEVOM I TUŠ RUČICOM

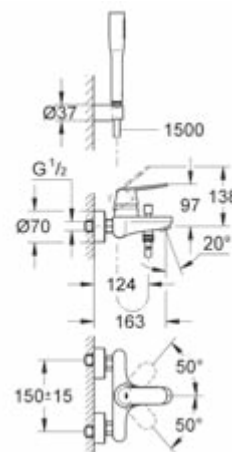

| ŠIFRA VOKEL    | BOJA | ŠIFRA ARTIKLA | PAKIRANJE |
|----------------|------|---------------|-----------|
| <b>0437111</b> | KROM | 32832000      | 1         |

BATERIJA ZA KADU  
BEZ CRIJEVA I TUŠ RUČICE

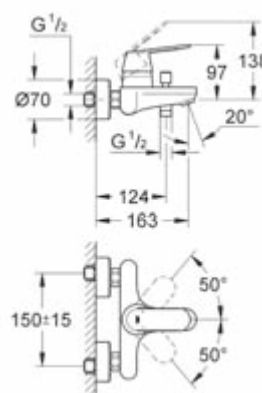

| ŠIFRA VOKEL    | BOJA | ŠIFRA ARTIKLA | PAKIRANJE |
|----------------|------|---------------|-----------|
| <b>0437156</b> | KROM | 32831000      | 1         |

BATERIJA ZA TUŠ

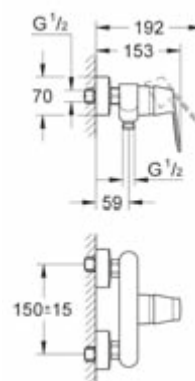

| ŠIFRA VOKEL    | BOJA | ŠIFRA ARTIKLA | PAKIRANJE |
|----------------|------|---------------|-----------|
| <b>0437112</b> | KROM | 32837000      | 1         |

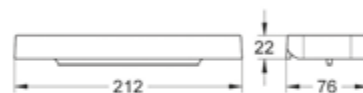

POLICA ZA BATERIJU

| ŠIFRA VOKEL    | BOJA | ŠIFRA ARTIKLA | PAKIRANJE |
|----------------|------|---------------|-----------|
| <b>0437113</b> | KROM | 18349000      | 1         |

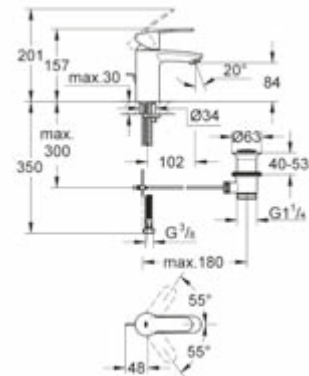

BATERIJA ZA UMIVAONIK

| ŠIFRA VOKEL    | BOJA | ŠIFRA ARTIKLA | PAKIRANJE |
|----------------|------|---------------|-----------|
| <b>0437125</b> | KROM | 33552002      | 1         |



PODŽBUKNI MEHANIZAM  
ZA PODŽBUKNU BATERIJU ZA UMIVAONIK

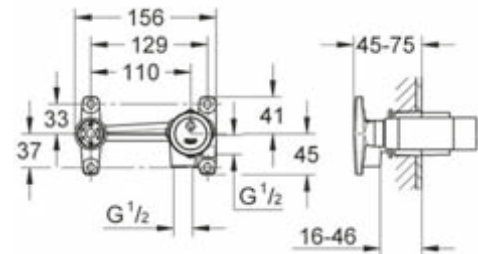

| ŠIFRA VOKEL    | BOJA | ŠIFRA ARTIKLA | PAKIRANJE |
|----------------|------|---------------|-----------|
| <b>0437197</b> | KROM | 32635000      | 1         |

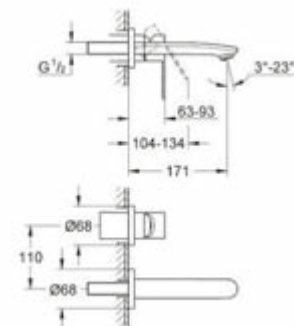

PODŽBUKNA BATERIJA

| ŠIFRA VOKEL    | BOJA | ŠIFRA ARTIKLA | PAKIRANJE |
|----------------|------|---------------|-----------|
| <b>0437207</b> | KROM | 19571002      | 1         |

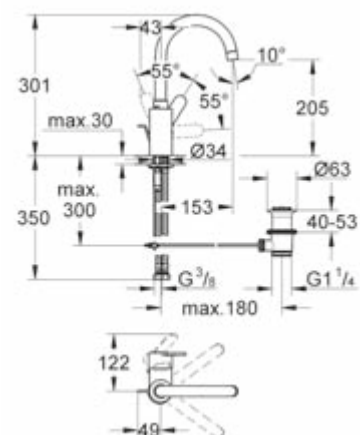

BATERIJA ZA UMIVAONIK  
VISOKI IZLJEV

| ŠIFRA VOKEL    | BOJA | ŠIFRA ARTIKLA | PAKIRANJE |
|----------------|------|---------------|-----------|
| <b>0437129</b> | KROM | 23043002      | 1         |

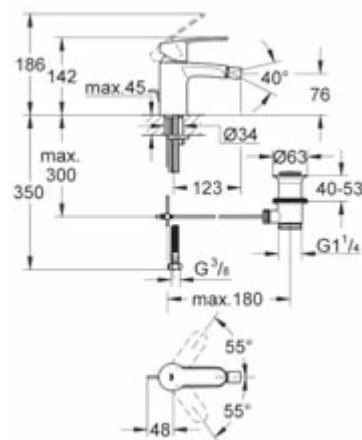

### BATERIJA ZA BIDE

| ŠIFRA VOKEL    | BOJA | ŠIFRA ARTIKLA | PAKIRANJE |
|----------------|------|---------------|-----------|
| <b>0437126</b> | KROM | 33565002      | 1         |

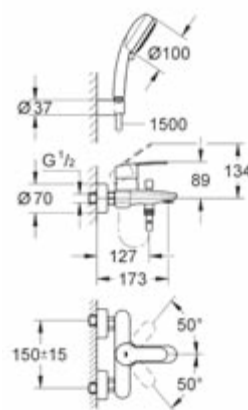

### BATERIJA ZA KADU SA CRIJEVOM I TUŠ RUČICOM

| ŠIFRA VOKEL    | BOJA | ŠIFRA ARTIKLA | PAKIRANJE |
|----------------|------|---------------|-----------|
| <b>0437127</b> | KROM | 33592002      | 1         |

### BEZ CRIJEVA I TUŠ RUČICE

| ŠIFRA VOKEL    | BOJA | ŠIFRA ARTIKLA | PAKIRANJE |
|----------------|------|---------------|-----------|
| <b>0437161</b> | KROM | 33591002      | 1         |

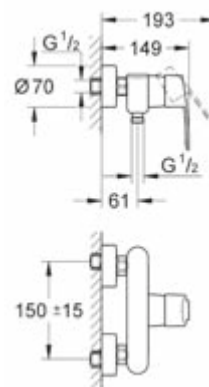

### BATERIJA ZA TUŠ

| ŠIFRA VOKEL    | BOJA | ŠIFRA ARTIKLA | PAKIRANJE |
|----------------|------|---------------|-----------|
| <b>0437128</b> | KROM | 33590002      | 1         |



### POLICA ZA TUŠ BATERIJU

| ŠIFRA VOKEL    | BOJA | ŠIFRA ARTIKLA | PAKIRANJE |
|----------------|------|---------------|-----------|
| <b>0437130</b> | KROM | 18383002      | 1         |



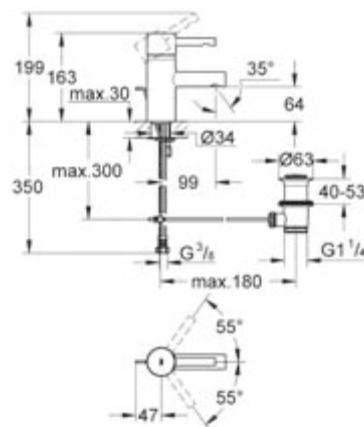

BATERIJA ZA UMIVAONIK

| ŠIFRA VOKEL    | BOJA | ŠIFRA ARTIKLA | PAKIRANJE |
|----------------|------|---------------|-----------|
| <b>0437061</b> | KROM | 33562000      | 1         |

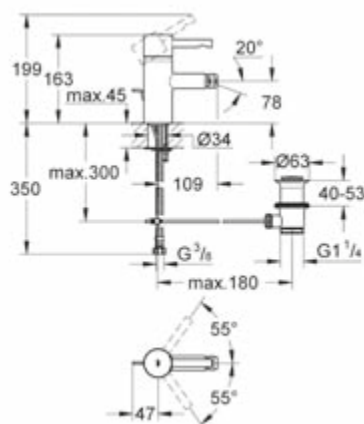

BATERIJA ZA BIDE

| ŠIFRA VOKEL    | BOJA | ŠIFRA ARTIKLA | PAKIRANJE |
|----------------|------|---------------|-----------|
| <b>0437053</b> | KROM | 33603000      | 1         |

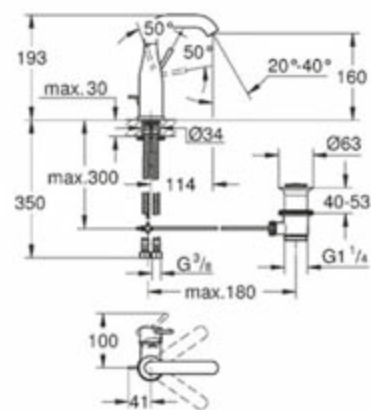

BATERIJA ZA UMIVAONIK  
ESSENCE NEW

| ŠIFRA VOKEL    | BOJA | ŠIFRA ARTIKLA | PAKIRANJE |
|----------------|------|---------------|-----------|
| <b>0437203</b> | KROM | 23462001      | 1         |

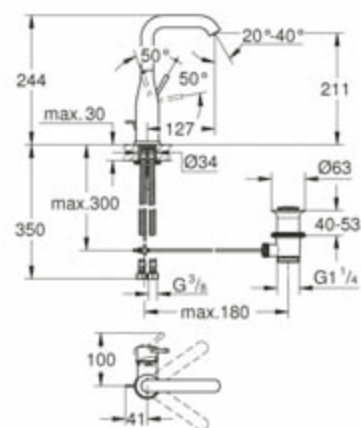

BATERIJA ZA UMIVAONIK XL  
ESSENCE NEW

| ŠIFRA VOKEL    | BOJA | ŠIFRA ARTIKLA | PAKIRANJE |
|----------------|------|---------------|-----------|
| <b>0437204</b> | KROM | 32628001      | 1         |

BATERIJA ZA UMIVAONIK-VISOKA  
ESSENCE NEW

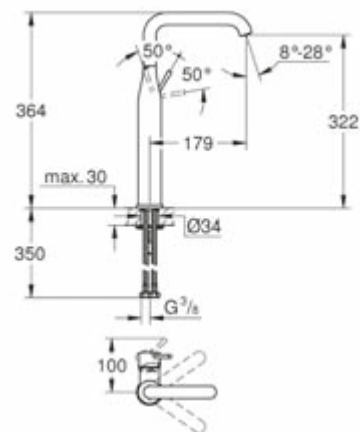

| ŠIFRA VOKEL    | BOJA | ŠIFRA ARTIKLA | PAKIRANJE |
|----------------|------|---------------|-----------|
| <b>0437205</b> | KROM | 32901001      | 1         |

BATERIJA ZA KADU

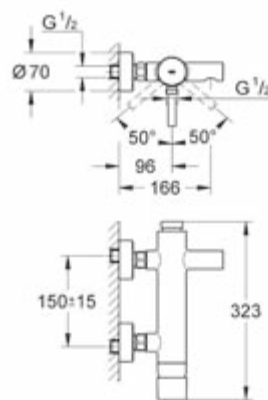

| ŠIFRA VOKEL    | BOJA | ŠIFRA ARTIKLA | PAKIRANJE |
|----------------|------|---------------|-----------|
| <b>0437062</b> | KROM | 33624000      | 1         |

BATERIJA ZA TUŠ

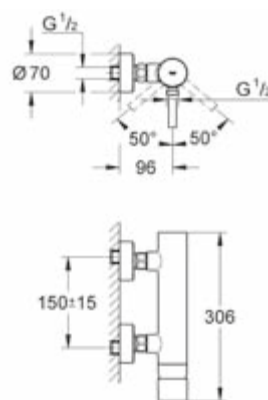

| ŠIFRA VOKEL    | BOJA | ŠIFRA ARTIKLA | PAKIRANJE |
|----------------|------|---------------|-----------|
| <b>0437047</b> | KROM | 33636000      | 1         |

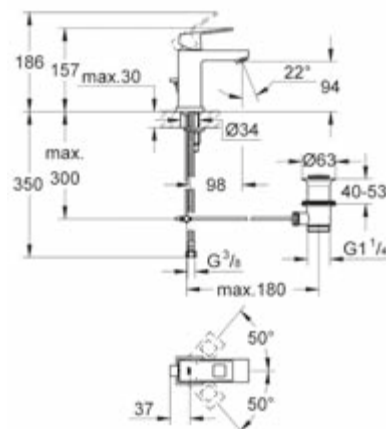

BATERIJA ZA UMIVAONIK

| ŠIFRA VOKEL    | BOJA | ŠIFRA ARTIKLA | PAKIRANJE |
|----------------|------|---------------|-----------|
| <b>0437138</b> | KROM | 23127000      | 1         |

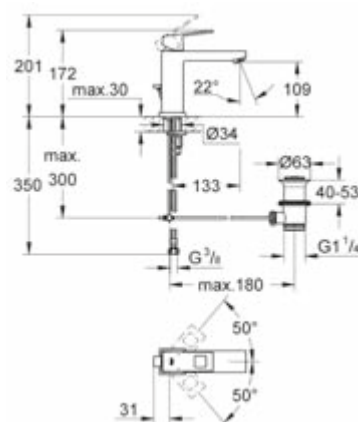

BATERIJA ZA UMIVAONIK XL

| ŠIFRA VOKEL    | BOJA | ŠIFRA ARTIKLA | PAKIRANJE |
|----------------|------|---------------|-----------|
| <b>0437183</b> | KROM | 23445000      | 1         |

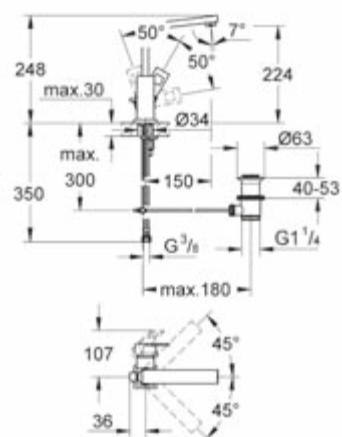

BATERIJA ZA UMIVAONIK-VISOKA

| ŠIFRA VOKEL    | BOJA | ŠIFRA ARTIKLA | PAKIRANJE |
|----------------|------|---------------|-----------|
| <b>0437139</b> | KROM | 23135000      | 1         |

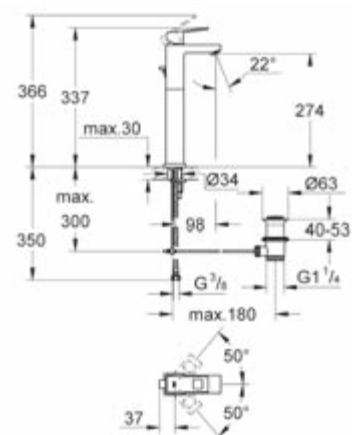

BATERIJA ZA SAMOSTOJEĆI UMIVAONIK  
KRATKI IZLJEV

| ŠIFRA VOKEL    | BOJA | ŠIFRA ARTIKLA | PAKIRANJE |
|----------------|------|---------------|-----------|
| <b>0437140</b> | KROM | 23136000      | 1         |

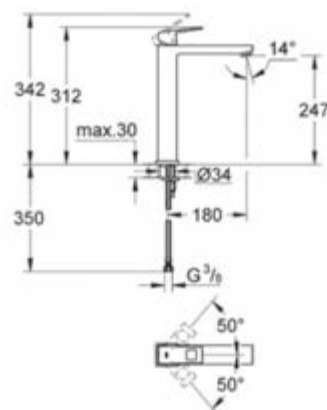

BATERIJA ZA SAMOSTOJEĆI UMIVAONIK  
DUGI IZLJEV

| ŠIFRA VOKEL    | BOJA | ŠIFRA ARTIKLA | PAKIRANJE |
|----------------|------|---------------|-----------|
| <b>0437192</b> | KROM | 23406000      | 1         |

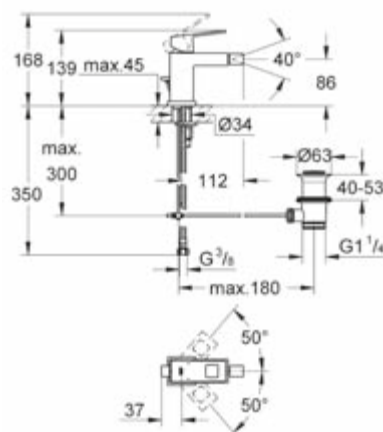

BATERIJA ZA BIDE

| ŠIFRA VOKEL    | BOJA | ŠIFRA ARTIKLA | PAKIRANJE |
|----------------|------|---------------|-----------|
| <b>0437141</b> | KROM | 23138000      | 1         |

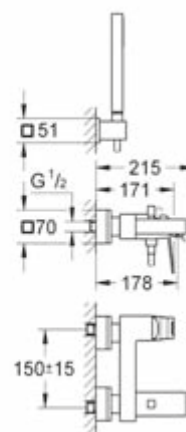

BATERIJA ZA KADU

| ŠIFRA VOKEL    | BOJA | ŠIFRA ARTIKLA | PAKIRANJE |
|----------------|------|---------------|-----------|
| <b>0437143</b> | KROM | 23141000      | 1         |

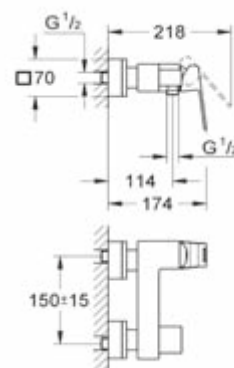

BATERIJA ZA TUŠ

| ŠIFRA VOKEL    | BOJA | ŠIFRA ARTIKLA | PAKIRANJE |
|----------------|------|---------------|-----------|
| <b>0437142</b> | KROM | 23145000      | 1         |

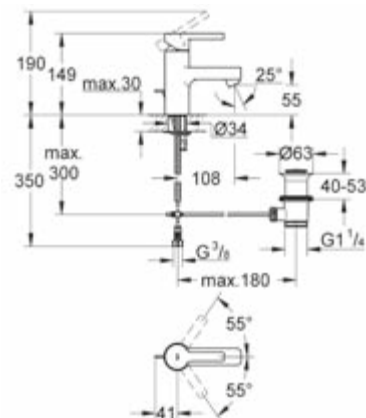

BATERIJA ZA UMIVAONIK

| ŠIFRA VOKEL    | BOJA | ŠIFRA ARTIKLA | PAKIRANJE |
|----------------|------|---------------|-----------|
| <b>0437099</b> | KROM | 32115000      | 1         |

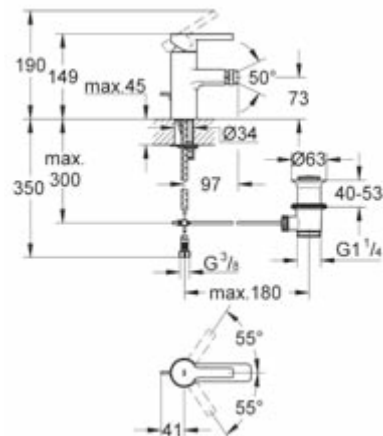

BATERIJA ZA BIDE

| ŠIFRA VOKEL    | BOJA | ŠIFRA ARTIKLA | PAKIRANJE |
|----------------|------|---------------|-----------|
| <b>0437101</b> | KROM | 33848000      | 1         |

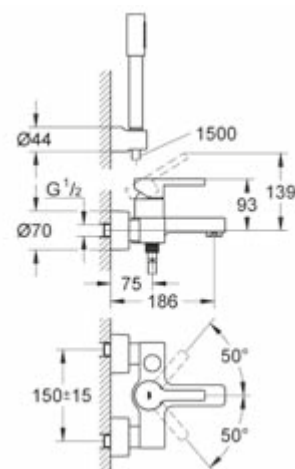

BATERIJA ZA KADU  
SA CRIJEVOM I TUŠ RUČICOM

| ŠIFRA VOKEL    | BOJA | ŠIFRA ARTIKLA | PAKIRANJE |
|----------------|------|---------------|-----------|
| <b>0437100</b> | KROM | 33850000      | 1         |

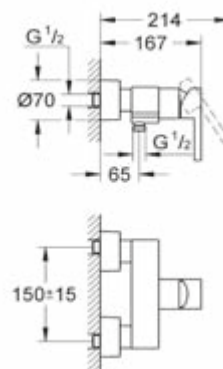

BATERIJA ZA TUŠ

| ŠIFRA VOKEL    | BOJA | ŠIFRA ARTIKLA | PAKIRANJE |
|----------------|------|---------------|-----------|
| <b>0437102</b> | KROM | 33865000      | 1         |



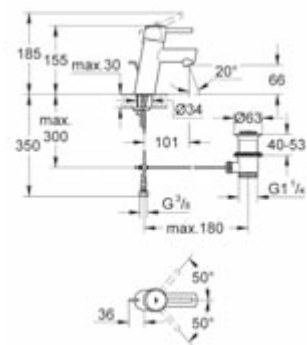

BATERIJA ZA UMIVAONIK

| ŠIFRA VOKEL    | BOJA | ŠIFRA ARTIKLA | PAKIRANJE |
|----------------|------|---------------|-----------|
| <b>0437177</b> | KROM | 32204001      | 1         |

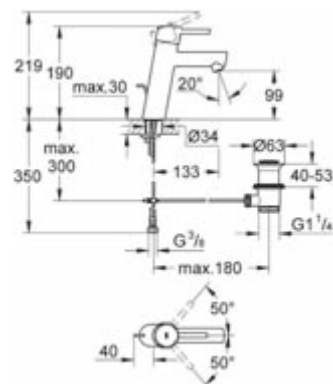

BATERIJA ZA UMIVAONIK XL

| ŠIFRA VOKEL    | BOJA | ŠIFRA ARTIKLA | PAKIRANJE |
|----------------|------|---------------|-----------|
| <b>0437200</b> | KROM | 23450001      | 1         |

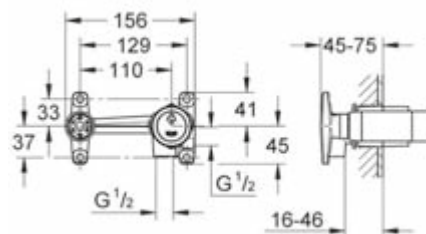

PODŽBUKNI MECHANIZAM  
ZA PODŽBUKNU BATERIJU ZA UMIVAONIK

| ŠIFRA VOKEL    | BOJA | ŠIFRA ARTIKLA | PAKIRANJE |
|----------------|------|---------------|-----------|
| <b>0437197</b> | KROM | 32635000      | 1         |

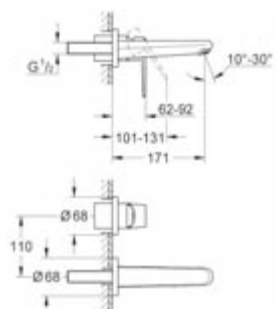

PODŽBUKNA BATERIJA ZA UMIVAONIK

| ŠIFRA VOKEL    | BOJA | ŠIFRA ARTIKLA | PAKIRANJE |
|----------------|------|---------------|-----------|
| <b>0437206</b> | KROM | 19575001      | 1         |

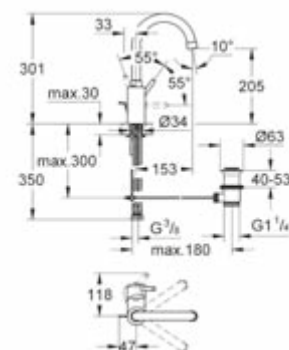

BATERIJA ZA UMIVAONIK-VISOKA

| ŠIFRA VOKEL    | BOJA | ŠIFRA ARTIKLA | PAKIRANJE |
|----------------|------|---------------|-----------|
| <b>0437178</b> | KROM | 32629001      | 1         |

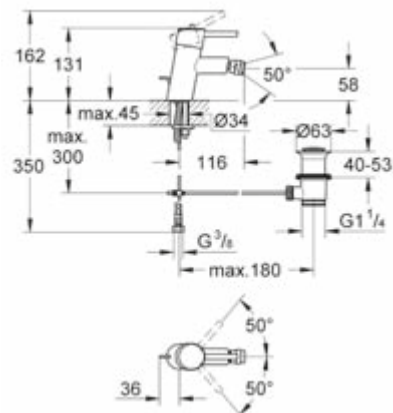

### BATERIJA ZA BIDE

| ŠIFRA VOKEL    | BOJA | ŠIFRA ARTIKLA | PAKIRANJE |
|----------------|------|---------------|-----------|
| <b>0437179</b> | KROM | 32208001      | 1         |

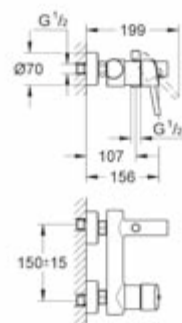

### BATERIJA ZA KADU BEZ CRIJEVA I TUŠ RUČICE

| ŠIFRA VOKEL    | BOJA | ŠIFRA ARTIKLA | PAKIRANJE |
|----------------|------|---------------|-----------|
| <b>0437180</b> | KROM | 32211001      | 1         |

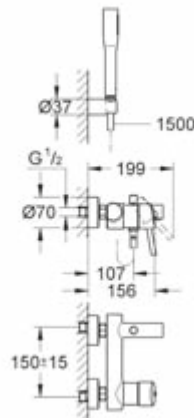

### BATERIJA ZA KADU SA CRIJEVOM I TUŠ RUČICOM

| ŠIFRA VOKEL    | BOJA | ŠIFRA ARTIKLA | PAKIRANJE |
|----------------|------|---------------|-----------|
| <b>0437181</b> | KROM | 32212001      | 1         |

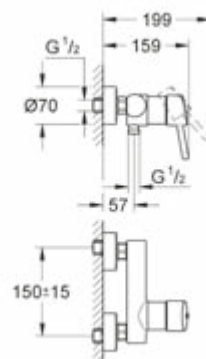

### BATERIJA ZA TUŠ

| ŠIFRA VOKEL    | BOJA | ŠIFRA ARTIKLA | PAKIRANJE |
|----------------|------|---------------|-----------|
| <b>0437182</b> | KROM | 32210001      | 1         |

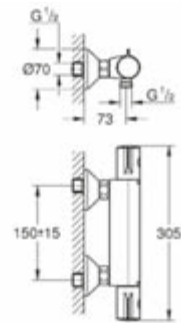

BATERIJA ZA TUŠ - GRT800

| ŠIFRA VOKEL    | BOJA | ŠIFRA ARTIKLA | PAKIRANJE |
|----------------|------|---------------|-----------|
| <b>0437194</b> | KROM | 34558000      | 1         |

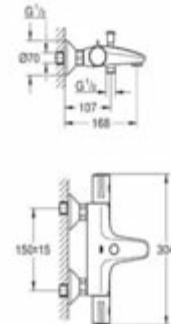

BATERIJA ZA KADU - GRT800

| ŠIFRA VOKEL    | BOJA | ŠIFRA ARTIKLA | PAKIRANJE |
|----------------|------|---------------|-----------|
| <b>0437193</b> | KROM | 34567000      | 1         |

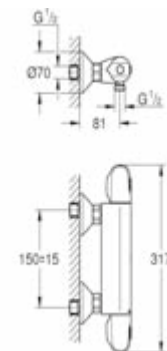

BATERIJA ZA TUŠ - GRT100

| ŠIFRA VOKEL    | BOJA | ŠIFRA ARTIKLA | PAKIRANJE |
|----------------|------|---------------|-----------|
| <b>0437196</b> | KROM | 34143003      | 1         |

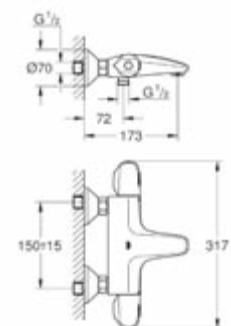

BATERIJA ZA KADU - GRT1000

| ŠIFRA VOKEL    | BOJA | ŠIFRA ARTIKLA | PAKIRANJE |
|----------------|------|---------------|-----------|
| <b>0437195</b> | KROM | 34155003      | 1         |

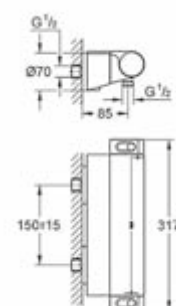

BATERIJA ZA TUŠ - GRT2000

| ŠIFRA VOKEL    | BOJA | ŠIFRA ARTIKLA | PAKIRANJE |
|----------------|------|---------------|-----------|
| <b>0437157</b> | KROM | 34469001      | 1         |

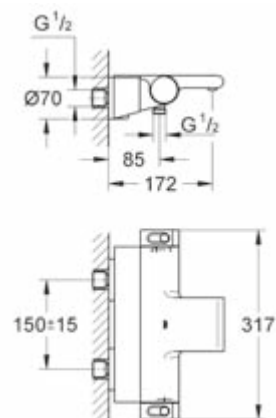

BATERIJA ZA KADU- GRT2000

| ŠIFRA VOKEL | BOJA | ŠIFRA ARTIKLA | PAKIRANJE |
|-------------|------|---------------|-----------|
| 0437158     | KROM | 34464001      | 1         |

## SPECIJALNE BATERIJE

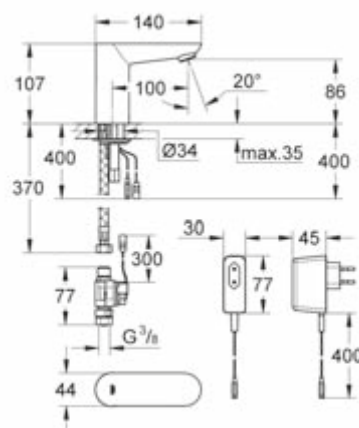

SENZORSKA BATERIJA ZA UMIVAONIK  
EUROECO COSMOPOLITAN

| ŠIFRA VOKEL | BOJA | ŠIFRA ARTIKLA | PAKIRANJE |
|-------------|------|---------------|-----------|
| 0437188     | KROM | 36269000      | 1         |

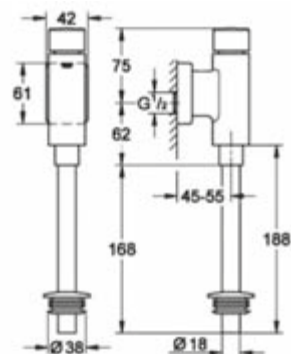

NADŽBUKNI ISPIRAČ ZA PISOAR  
AUTOMATSKI NA PRITISAK

| ŠIFRA VOKEL | BOJA | ŠIFRA ARTIKLA | PAKIRANJE |
|-------------|------|---------------|-----------|
| 0531043     | KROM | 37346000      | 1         |



MINTA  
SA 2 CIJEVI

| ŠIFRA VOKEL    | BOJA | ŠIFRA ARTIKLA | PAKIRANJE |
|----------------|------|---------------|-----------|
| <b>0437036</b> | KROM | 32917000      | 1         |

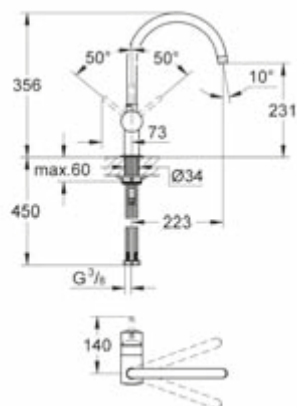

CONETTO  
NA IZVLAČENJE SA 2 CIJEVI

| ŠIFRA VOKEL    | BOJA | ŠIFRA ARTIKLA | PAKIRANJE |
|----------------|------|---------------|-----------|
| <b>0437131</b> | KROM | 32663001      | 1         |

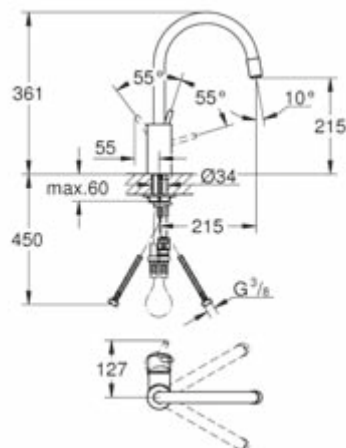

ESSENCE  
SA 2 CIJEVI

| ŠIFRA VOKEL    | BOJA | ŠIFRA ARTIKLA | PAKIRANJE |
|----------------|------|---------------|-----------|
| <b>0437069</b> | KROM | 32105000      | 1         |

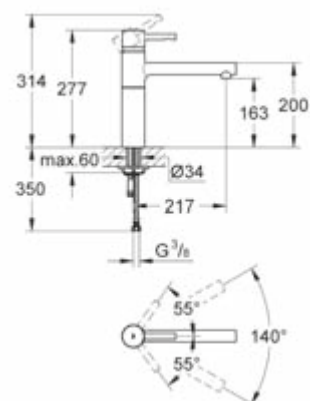

ESSENCE  
SA 2 CIJEVI I CRIJEVOM NA IZVLAČENJE

| ŠIFRA VOKEL    | BOJA | ŠIFRA ARTIKLA | PAKIRANJE |
|----------------|------|---------------|-----------|
| <b>0437048</b> | KROM | 32171000      | 1         |

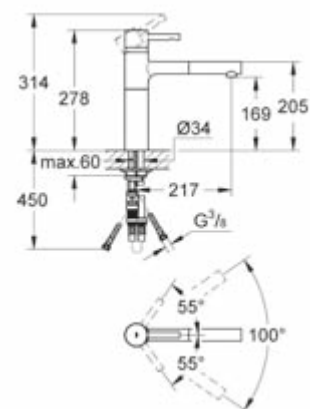



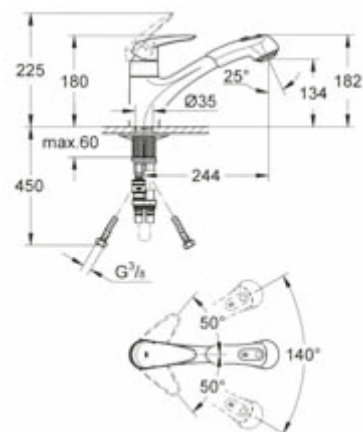

EURODISC  
S CRIJEVOM NA IZVLAČENJE

| ŠIFRA VOKEL    | BOJA | ŠIFRA ARTIKLA | PAKIRANJE |
|----------------|------|---------------|-----------|
| <b>0437162</b> | KROM | 32257001      | 1         |

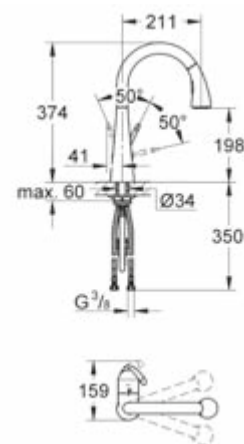

ZEDRA  
NA IZVLAČENJE SA 2 CIJEVI

| ŠIFRA VOKEL    | BOJA | ŠIFRA ARTIKLA | PAKIRANJE |
|----------------|------|---------------|-----------|
| <b>0437174</b> | KROM | 32294001      | 1         |

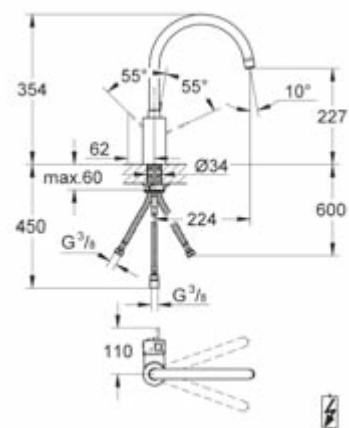

EUROSMART COSMOPOLITAN  
SA 3 CIJEVI - VISOKI IZLJEV

| ŠIFRA VOKEL    | BOJA | ŠIFRA ARTIKLA | PAKIRANJE |
|----------------|------|---------------|-----------|
| <b>0437122</b> | KROM | 31180000      | 1         |

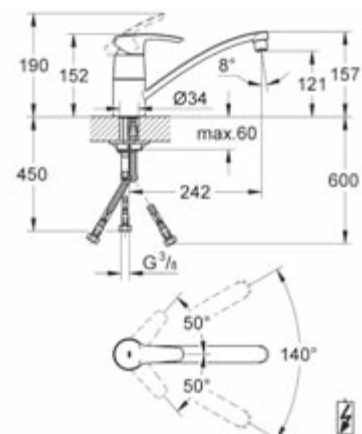

EUROSTYLE  
SA 3 CIJEVI

| ŠIFRA VOKEL    | BOJA | ŠIFRA ARTIKLA | PAKIRANJE |
|----------------|------|---------------|-----------|
| <b>0437117</b> | KROM | 33984001      | 1         |

BAUEDGE  
SA 2 CIJEVI

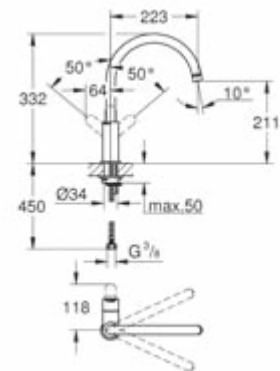

| ŠIFRA VOKEL    | BOJA | ŠIFRA ARTIKLA | PAKIRANJE |
|----------------|------|---------------|-----------|
| <b>0437167</b> | KROM | 31367000      | 1         |

EUROSMART  
SA 2 CIJEVI

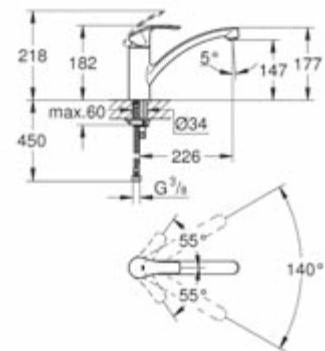

| ŠIFRA VOKEL    | BOJA | ŠIFRA ARTIKLA | PAKIRANJE |
|----------------|------|---------------|-----------|
| <b>0437090</b> | KROM | 33281002      | 1         |

EUROSMART  
SA 2 CIJEVI

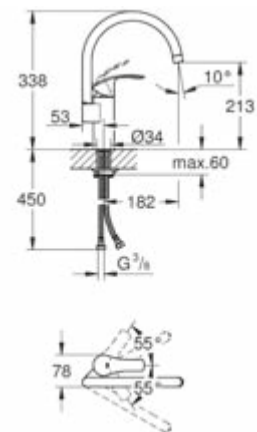

| ŠIFRA VOKEL    | BOJA | ŠIFRA ARTIKLA | PAKIRANJE |
|----------------|------|---------------|-----------|
| <b>0437095</b> | KROM | 33202002      | 1         |

EUROSMART COSMOPOLITAN  
SA 2 CIJEVI VISOKI IZLJEV

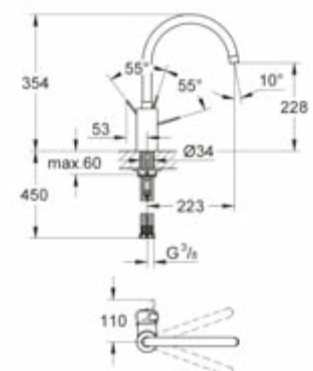

| ŠIFRA VOKEL    | BOJA | ŠIFRA ARTIKLA | PAKIRANJE |
|----------------|------|---------------|-----------|
| <b>0437123</b> | KROM | 32843000      | 1         |

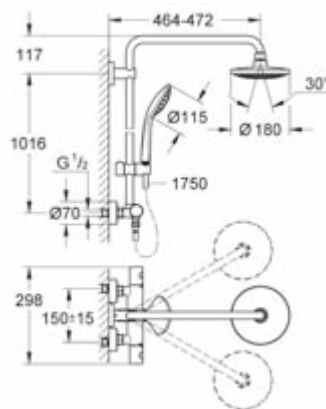

BATERIJA ZA TUŠ-EUPHORIA  
SA FIKSNIM TUŠEM, CRIJEVOM I RUČICOM

| ŠIFRA VOKEL    | BOJA | ŠIFRA ARTIKLA | PAKIRANJE |
|----------------|------|---------------|-----------|
| <b>0437107</b> | KROM | 27296001      | 1         |

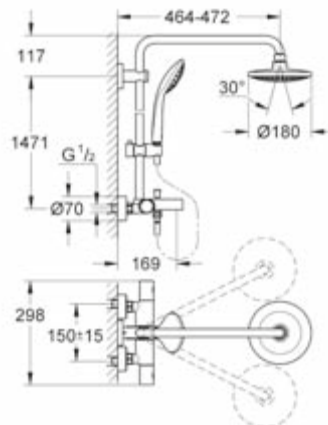

BATERIJA ZA KADU - EUPHORIA  
SA FIKSNIM TUŠEM, CRIJEVOM I RUČICOM

| ŠIFRA VOKEL    | BOJA | ŠIFRA ARTIKLA | PAKIRANJE |
|----------------|------|---------------|-----------|
| <b>0437120</b> | KROM | 27475000      | 1         |

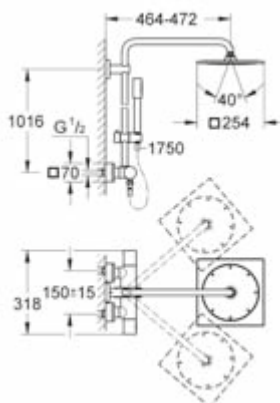

BATERIJA ZA TUŠ-RAINSHOWER  
SA POKRETNIM TUŠEM, CRIJEVOM I RUČICOM

| ŠIFRA VOKEL    | BOJA | ŠIFRA ARTIKLA | PAKIRANJE |
|----------------|------|---------------|-----------|
| <b>0437136</b> | KROM | 27469000      | 1         |

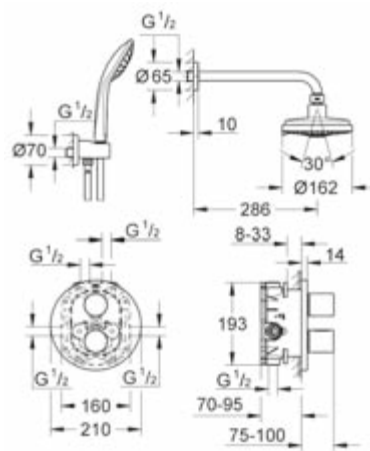

UGRADNA BATERIJA ZA TUŠ  
GROHTHERM 3000 - KOMPLET SET

| ŠIFRA VOKEL    | BOJA | ŠIFRA ARTIKLA | PAKIRANJE |
|----------------|------|---------------|-----------|
| <b>0437124</b> | KROM | 34399000      | 1         |

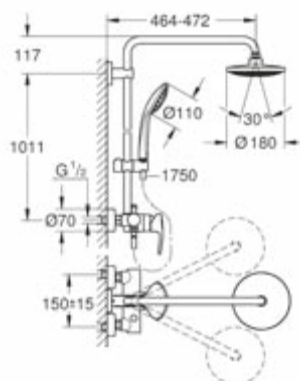

BATERIJA ZA TUŠ - EUPHORIA  
SA FIKSNIM TUŠEM, CRIJEVOM I RUČICOM

| ŠIFRA VOKEL    | BOJA | ŠIFRA ARTIKLA | PAKIRANJE |
|----------------|------|---------------|-----------|
| <b>0437121</b> | KROM | 27473000      | 1         |

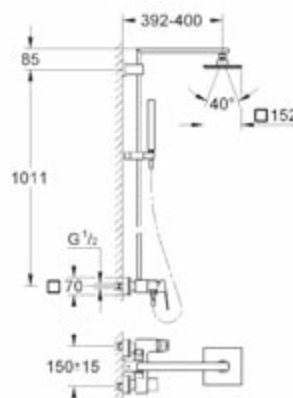

BATERIJA ZA TUŠ -EUROCUBE  
SA FIKSNIM TUŠEM, CRIJEVOM I RUČICOM

| ŠIFRA VOKEL    | BOJA | ŠIFRA ARTIKLA | PAKIRANJE |
|----------------|------|---------------|-----------|
| <b>0437171</b> | KROM | 23147000      | 1         |

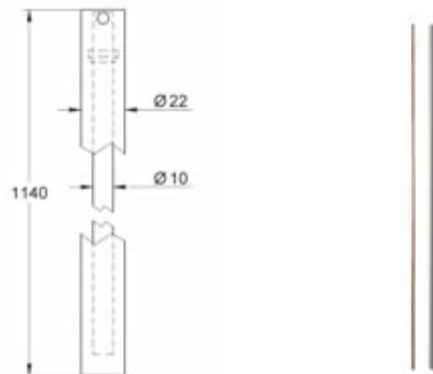

PRODUŽETAK ZA EUPHORIU

| ŠIFRA VOKEL    | BOJA | ŠIFRA ARTIKLA | PAKIRANJE |
|----------------|------|---------------|-----------|
| <b>0437151</b> | KROM | 48053000      | 1         |



TUŠ SISTEM S 2 RUŽE  
FREEHANDER

| ŠIFRA VOKEL  | BOJA | ŠIFRA ARTIKLA | PAKIRANJE |
|--------------|------|---------------|-----------|
| <b>74027</b> | KROM | 27004000      | 1         |



## RAPIDO E PODŽBUKNI MEHANIZAM

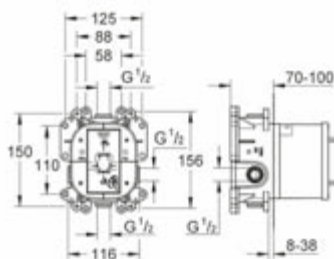

| ŠIFRA VOKEL    | BOJA | ŠIFRA ARTIKLA | PAKIRANJE |
|----------------|------|---------------|-----------|
| <b>0437134</b> | KROM | 35501000      | 1         |

## RAPIDO T PODŽBUKNI MEHANIZAM ZA TERMOSTATSKU BATERIJU

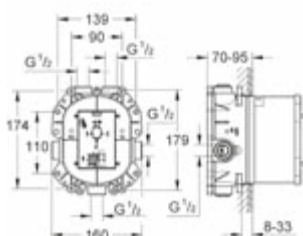

| ŠIFRA VOKEL    | BOJA | ŠIFRA ARTIKLA | PAKIRANJE |
|----------------|------|---------------|-----------|
| <b>0437172</b> | KROM | 35500000      | 1         |

## PODŽBUKNI VENTIL 1/2"

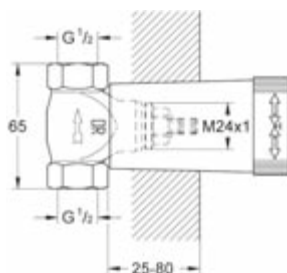

| ŠIFRA VOKEL    | BOJA | ŠIFRA ARTIKLA | PAKIRANJE |
|----------------|------|---------------|-----------|
| <b>0437175</b> | KROM | 29811000      | 1         |

## PODŽBUKNI MEHANIZAM ZA PODŽBUKNU BATERIJU ZA UMIVAONIK

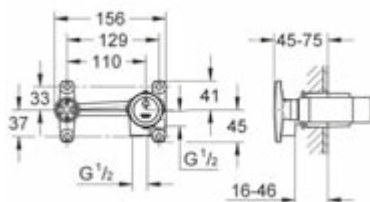

| ŠIFRA VOKEL    | BOJA | ŠIFRA ARTIKLA | PAKIRANJE |
|----------------|------|---------------|-----------|
| <b>0437197</b> | KROM | 32635000      | 1         |

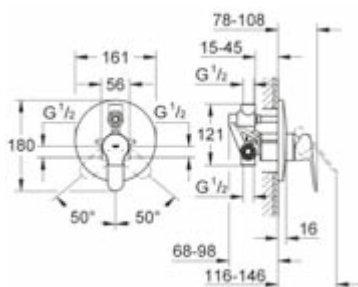

BAUEDGE - ZA KADU  
S PODŽBUKNIM MECHANIZMOM

| ŠIFRA VOKEL    | BOJA | ŠIFRA ARTIKLA | PAKIRANJE |
|----------------|------|---------------|-----------|
| <b>0437184</b> | KROM | 29079000      | 1         |

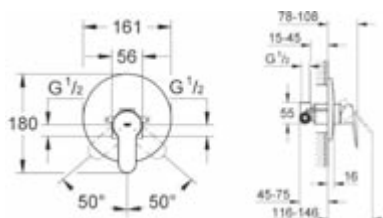

BAUEDGE - ZA TUŠ  
S PODŽBUKNIM MECHANIZMOM

| ŠIFRA VOKEL    | BOJA | ŠIFRA ARTIKLA | PAKIRANJE |
|----------------|------|---------------|-----------|
| <b>0437185</b> | KROM | 29078000      | 1         |

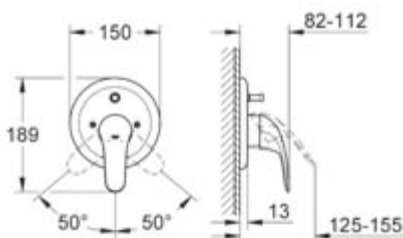

EUROSART - ZA KADU  
BEZ PODŽBUKNOG MECHANIZMA

| ŠIFRA VOKEL    | BOJA | ŠIFRA ARTIKLA | PAKIRANJE |
|----------------|------|---------------|-----------|
| <b>0437066</b> | KROM | 19450002      | 1         |

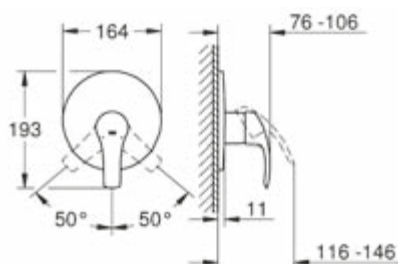

EUROSART - ZA TUŠ  
BEZ PODŽBUKNOG MECHANIZMA

| ŠIFRA VOKEL    | BOJA | ŠIFRA ARTIKLA | PAKIRANJE |
|----------------|------|---------------|-----------|
| <b>0437068</b> | KROM | 19451002      | 1         |

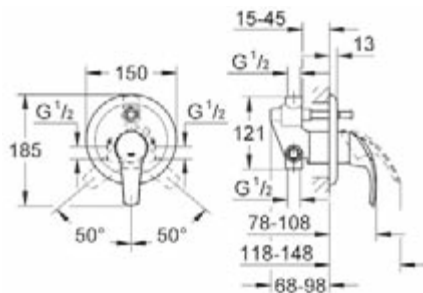

EUROSMART - ZA KADU  
S PODŽBUKNIM MECHANIZMOM

| ŠIFRA VOKEL    | BOJA | ŠIFRA ARTIKLA | PAKIRANJE |
|----------------|------|---------------|-----------|
| <b>0437087</b> | KROM | 33305002      | 1         |

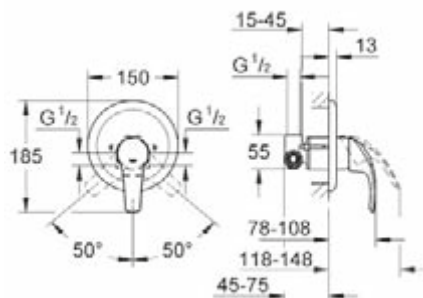

EUROSMART - ZA TUŠ  
S PODŽBUKNIM MECHANIZMOM

| ŠIFRA VOKEL    | BOJA | ŠIFRA ARTIKLA | PAKIRANJE |
|----------------|------|---------------|-----------|
| <b>0437085</b> | KROM | 33556002      | 1         |

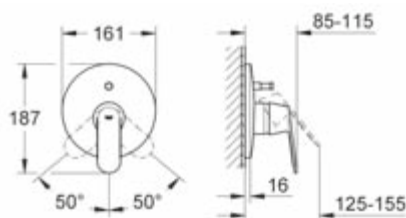

EUROSMART COSMOPOLITAN- ZA KADU  
BEZ PODŽBUKNOG MECHANIZMA

| ŠIFRA VOKEL    | BOJA | ŠIFRA ARTIKLA | PAKIRANJE |
|----------------|------|---------------|-----------|
| <b>0437212</b> | KROM | 19382000      | 1         |

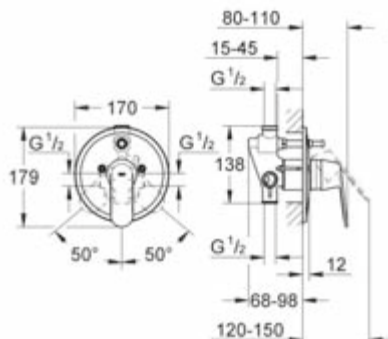

EUROSMART COSMOPOLITAN- ZA KADU  
S PODŽBUKNIM MECHANIZMOM

| ŠIFRA VOKEL    | BOJA | ŠIFRA ARTIKLA | PAKIRANJE |
|----------------|------|---------------|-----------|
| <b>0437213</b> | KROM | 32879000      | 1         |



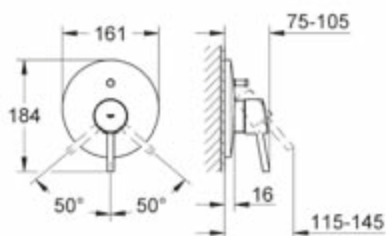

CONCETTO - ZA KADU  
BEZ PODŽBUKNOG MEHANIZMA

| ŠIFRA VOKEL    | BOJA | ŠIFRA ARTIKLA | PAKIRANJE |
|----------------|------|---------------|-----------|
| <b>0437186</b> | KROM | 19346001      | 1         |

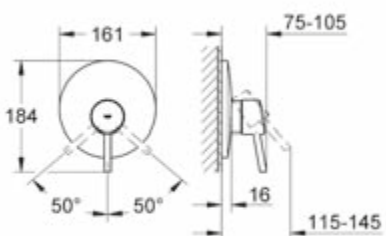

CONCETTO - ZA TUŠ  
BEZ PODŽBUKNOG MEHANIZMA

| ŠIFRA VOKEL    | BOJA | ŠIFRA ARTIKLA | PAKIRANJE |
|----------------|------|---------------|-----------|
| <b>0437187</b> | KROM | 19345001      | 1         |

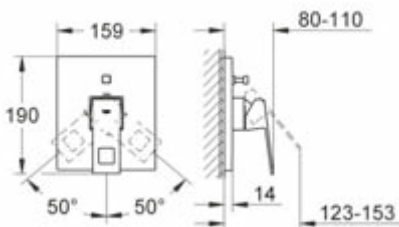

EUROCUBE - ZA KADU  
BEZ PODŽBUKNOG MEHANIZMA

| ŠIFRA VOKEL    | BOJA | ŠIFRA ARTIKLA | PAKIRANJE |
|----------------|------|---------------|-----------|
| <b>0437191</b> | KROM | 19896000      | 1         |



RELAX  
IZLJEV ZA TUŠ-1/2"

| ŠIFRA VOKEL    | BOJA | ŠIFRA ARTIKLA | PAKIRANJE |
|----------------|------|---------------|-----------|
| <b>0437133</b> | KROM | 27406000      | 1         |

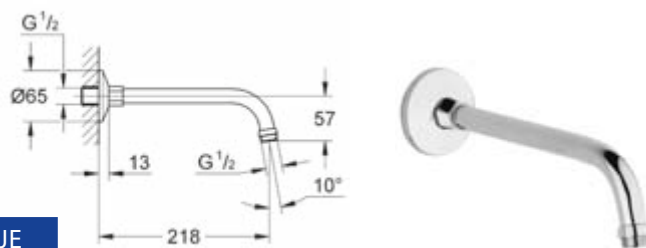

RAINSHOWER 286 mm  
ČETVRTASTI IZLJEV ZA TUŠ

| ŠIFRA VOKEL    | BOJA | ŠIFRA ARTIKLA | PAKIRANJE |
|----------------|------|---------------|-----------|
| <b>0437208</b> | KROM | 27709000      | 1         |

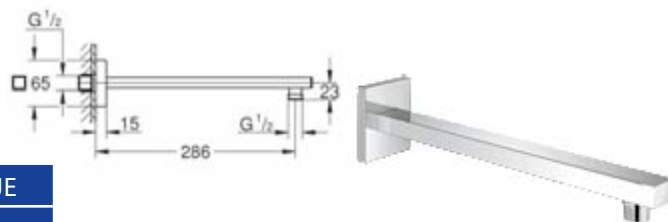

RELAX CHAMPAGNE  
IZLJEV ZA UGRADNI TUŠ

| ŠIFRA VOKEL    | BOJA | ŠIFRA ARTIKLA | PAKIRANJE |
|----------------|------|---------------|-----------|
| <b>0437065</b> | KROM | 28190000      | 1         |

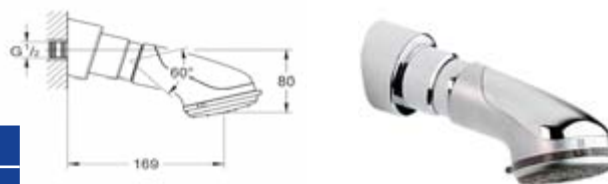

IZLJEV ZA KADU

| ŠIFRA VOKEL    | BOJA | ŠIFRA ARTIKLA | PAKIRANJE |
|----------------|------|---------------|-----------|
| <b>0437190</b> | KROM | 13261000      | 1         |



EUPHORIA COSMOPOLITAN  
TUŠ RUŽA Ø160

| ŠIFRA VOKEL    | BOJA | ŠIFRA ARTIKLA | PAKIRANJE |
|----------------|------|---------------|-----------|
| <b>0437132</b> | KROM | 28232000      | 1         |



EUPHORIA CUBE  
NADGLAVNI TUŠ 152x152 mm

| ŠIFRA VOKEL    | BOJA | ŠIFRA ARTIKLA | PAKIRANJE |
|----------------|------|---------------|-----------|
| <b>0437163</b> | KROM | 27705000      | 1         |

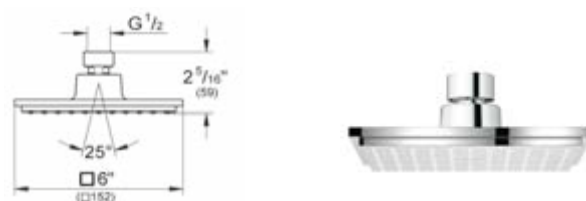

RAINSHOWER  
NADGLAVNI TUŠ 254x254 mm

| ŠIFRA VOKEL    | BOJA | ŠIFRA ARTIKLA | PAKIRANJE |
|----------------|------|---------------|-----------|
| <b>0437164</b> | KROM | 27271000      | 1         |





RAINSHOWER 154 mm  
ČETVRTASTI STROPNI IZLJEV ZA TUŠ

| ŠIFRA VOKEL    | BOJA | ŠIFRA ARTIKLA | PAKIRANJE |
|----------------|------|---------------|-----------|
| <b>0437209</b> | KROM | 27711000      | 1         |

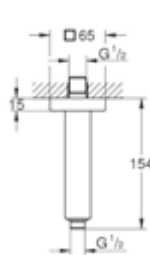

RAINSHOWER 142 mm  
OKRUGLI STROPNI IZLJEV ZA TUŠ

| ŠIFRA VOKEL    | BOJA | ŠIFRA ARTIKLA | PAKIRANJE |
|----------------|------|---------------|-----------|
| <b>0437210</b> | KROM | 28724000      | 1         |

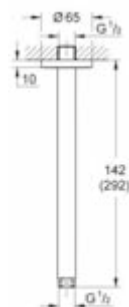

EUPHORIA CUBE  
KOLJENO ZA TUŠ

| ŠIFRA VOKEL    | BOJA | ŠIFRA ARTIKLA | PAKIRANJE |
|----------------|------|---------------|-----------|
| <b>0437211</b> | KROM | 27704000      | 1         |

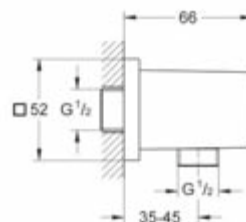

ZIDNO PRIKLJUČNO KOLJENO  
S ROZETOM

| ŠIFRA VOKEL  | BOJA | ŠIFRA ARTIKLA | PAKIRANJE |
|--------------|------|---------------|-----------|
| <b>74015</b> | KROM | 28626000      | 1         |

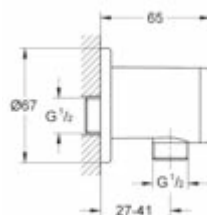

ZIDNO PRIKLJUČNO KOLJENO

| ŠIFRA VOKEL    | BOJA | ŠIFRA ARTIKLA | PAKIRANJE |
|----------------|------|---------------|-----------|
| <b>0437135</b> | KROM | 28628000      | 1         |

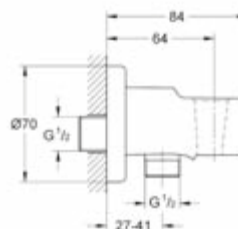

KUTNI VENTIL  
1/2" - 3/8"

| ŠIFRA VOKEL    | BOJA | ŠIFRA ARTIKLA | PAKIRANJE |
|----------------|------|---------------|-----------|
| <b>0437176</b> | KROM | 2201700M      | 1         |

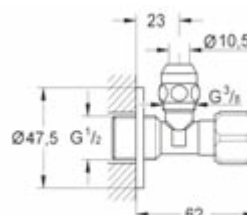

TEMPESTA NEW  
TUŠ KONZOLA S RUČICOM

| ŠIFRA VOKEL    | BOJA | ŠIFRA ARTIKLA | PAKIRANJE |
|----------------|------|---------------|-----------|
| <b>0437137</b> | KROM | 27598000      | 1         |



EUPHORIA  
GARNITURA ZA TUŠ

| ŠIFRA VOKEL    | BOJA | ŠIFRA ARTIKLA | PAKIRANJE |
|----------------|------|---------------|-----------|
| <b>0437115</b> | KROM | 27266001      | 1         |



RAINSHOWER  
GARNITURA ZA TUŠ

| ŠIFRA VOKEL    | BOJA | ŠIFRA ARTIKLA | PAKIRANJE |
|----------------|------|---------------|-----------|
| <b>0437116</b> | KROM | 27339000      | 1         |



RAINSHOWER  
KONZOLA ZA TUŠ Ø160

| ŠIFRA VOKEL    | BOJA | ŠIFRA ARTIKLA | PAKIRANJE |
|----------------|------|---------------|-----------|
| <b>0437054</b> | KROM | 28770001      | 1         |

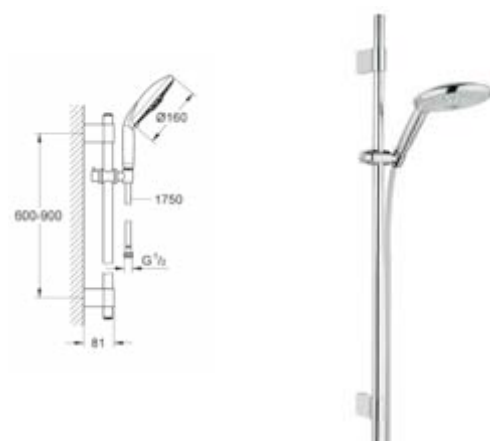

TEMPESTA NEW  
TUŠ KONZOLA

| ŠIFRA VOKEL    | BOJA | ŠIFRA ARTIKLA | PAKIRANJE |
|----------------|------|---------------|-----------|
| <b>0437159</b> | KROM | 27523000      | 1         |

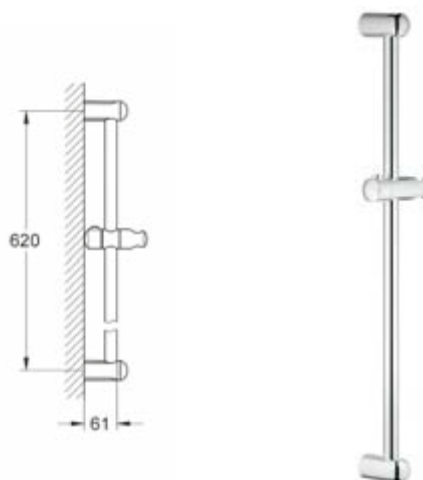

SOLO  
TUŠ KONZOLA

| ŠIFRA VOKEL  | BOJA | ŠIFRA ARTIKLA | PAKIRANJE |
|--------------|------|---------------|-----------|
| <b>74014</b> | KROM | 28620000      | 1         |

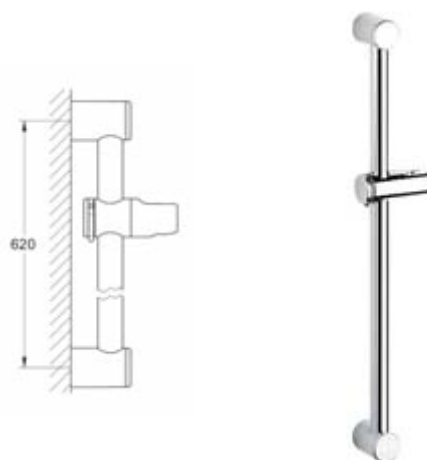

EUPHORIA CUBE  
TUŠ KONZOLA

| ŠIFRA VOKEL    | BOJA | ŠIFRA ARTIKLA | PAKIRANJE |
|----------------|------|---------------|-----------|
| <b>0437147</b> | KROM | 27892000      | 1         |

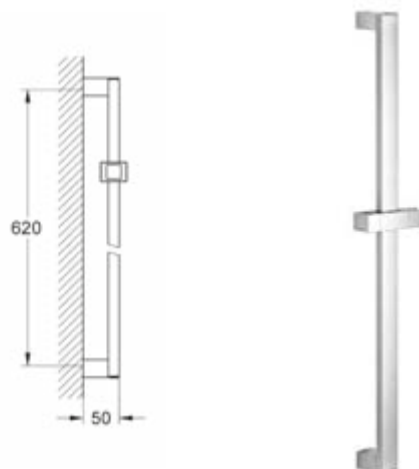

TEMPESTA NEW DUO  
TUŠ RUČICA S DRŽAČEM

| ŠIFRA VOKEL    | BOJA | ŠIFRA ARTIKLA | PAKIRANJE |
|----------------|------|---------------|-----------|
| <b>0437145</b> | KROM | 27597000      | 1         |



TEMPESTA III  
TUŠ RUČICA

| ŠIFRA VOKEL    | BOJA | ŠIFRA ARTIKLA | PAKIRANJE |
|----------------|------|---------------|-----------|
| <b>0437173</b> | KROM | 28261001      | 1         |



EUPHORIA  
TUŠ RUČICA

| ŠIFRA VOKEL    | BOJA | ŠIFRA ARTIKLA | PAKIRANJE |
|----------------|------|---------------|-----------|
| <b>0437114</b> | KROM | 27265000      | 1         |

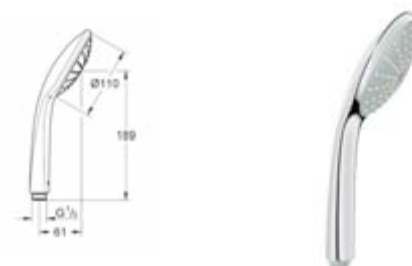

RAINSHOWER  
TUŠ RUČICA

| ŠIFRA VOKEL    | BOJA | ŠIFRA ARTIKLA | PAKIRANJE |
|----------------|------|---------------|-----------|
| <b>0437089</b> | KROM | 28765000      | 1         |



POWER SOUL  
TUŠ RUČICA

| ŠIFRA VOKEL    | BOJA | ŠIFRA ARTIKLA | PAKIRANJE |
|----------------|------|---------------|-----------|
| <b>0437144</b> | KROM | 27669000      | 1         |

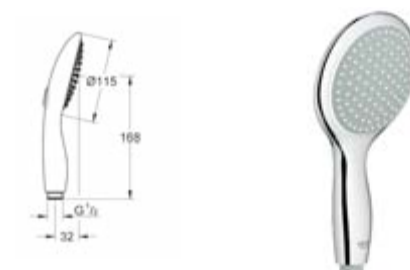

EUPHORIA CUBE  
TUŠ RUČICA

| ŠIFRA VOKEL    | BOJA | ŠIFRA ARTIKLA | PAKIRANJE |
|----------------|------|---------------|-----------|
| <b>0437148</b> | KROM | 27698000      | 1         |

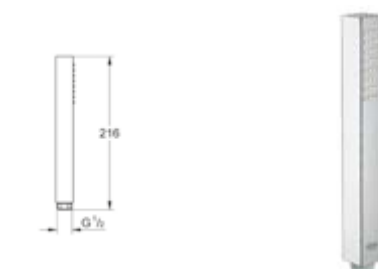

ZIDNI DRŽAČ TUŠA

| ŠIFRA VOKEL    | BOJA | ŠIFRA ARTIKLA | PAKIRANJE |
|----------------|------|---------------|-----------|
| <b>0437146</b> | KROM | 28605000      | 1         |

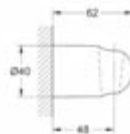

EUPHORIA  
ZIDNI DRŽAČ TUŠA

| ŠIFRA VOKEL    | BOJA | ŠIFRA ARTIKLA | PAKIRANJE |
|----------------|------|---------------|-----------|
| <b>0437153</b> | KROM | 27693000      | 1         |

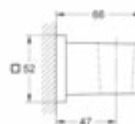

CRIJEVO ZA TUŠ-150 cm

| ŠIFRA VOKEL  | BOJA | ŠIFRA ARTIKLA | PAKIRANJE |
|--------------|------|---------------|-----------|
| <b>74013</b> | KROM | 28151000      | 1         |

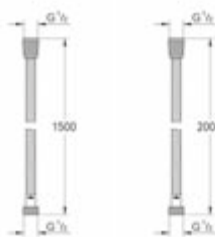

CRIJEVO ZA TUŠ-200 cm

| ŠIFRA VOKEL    | BOJA | ŠIFRA ARTIKLA | PAKIRANJE |
|----------------|------|---------------|-----------|
| <b>0437035</b> | KROM | 28155000      | 1         |

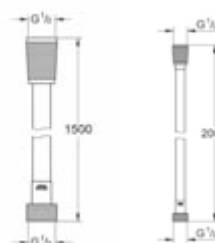

SILVERFLEX-CRIJEVO ZA TUŠ-150 cm

| ŠIFRA VOKEL    | BOJA | ŠIFRA ARTIKLA | PAKIRANJE |
|----------------|------|---------------|-----------|
| <b>0437202</b> | KROM | 28364000      | 1         |

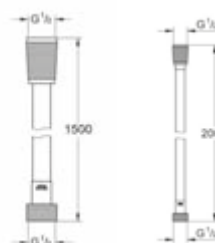

SILVERFLEX-CRIJEVO ZA TUŠ-200 cm

| ŠIFRA VOKEL    | BOJA | ŠIFRA ARTIKLA | PAKIRANJE |
|----------------|------|---------------|-----------|
| <b>0437201</b> | KROM | 27137000      | 1         |

SET ZA RUČNI TUŠ  
CRIJEVO + RUČICA S PREKIDAČEM

| ŠIFRA VOKEL    | BOJA | ŠIFRA ARTIKLA | PAKIRANJE |
|----------------|------|---------------|-----------|
| <b>0437154</b> | KROM | 27513000      | 1         |



SREDSTVO ZA ČIŠĆENJE  
500 ml

| ŠIFRA VOKEL    | BOJA | ŠIFRA ARTIKLA | PAKIRANJE |
|----------------|------|---------------|-----------|
| <b>0437149</b> | -    | 48166000      | 1         |







**JEDNORUČNE BATERIJE LEVEL**

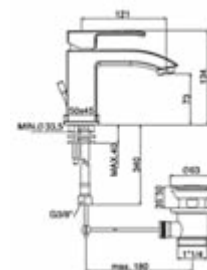

## BATERIJA ZA UMIVAONIK

| ŠIFRA VOKEL  | BOJA | ŠIFRA ARTIKLA | PAKIRANJE |
|--------------|------|---------------|-----------|
| <b>19318</b> | KROM | LES075CR      | 1         |

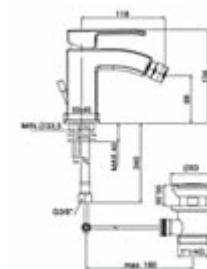

## BATERIJA ZA BIDE

| ŠIFRA VOKEL  | BOJA | ŠIFRA ARTIKLA | PAKIRANJE |
|--------------|------|---------------|-----------|
| <b>19319</b> | KROM | LES135CR      | 1         |

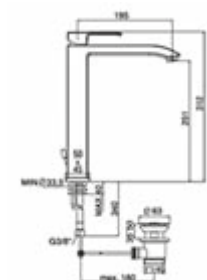

## BATERIJA ZA UMIVAONIK-PRODUŽENA

| ŠIFRA VOKEL  | BOJA | ŠIFRA ARTIKLA | PAKIRANJE |
|--------------|------|---------------|-----------|
| <b>19321</b> | KROM | LES085CR      | 1         |

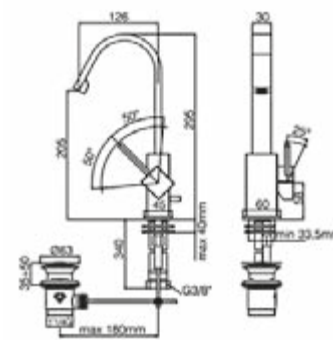

## BATERIJA ZA UMIVAONIK

| ŠIFRA VOKEL  | BOJA | ŠIFRA ARTIKLA | PAKIRANJE |
|--------------|------|---------------|-----------|
| <b>19325</b> | KROM | LEA877CR      | 1         |

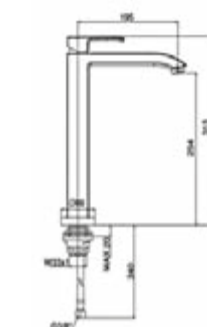

## BATERIJA ZA SUDOPER

| ŠIFRA VOKEL  | BOJA | ŠIFRA ARTIKLA | PAKIRANJE |
|--------------|------|---------------|-----------|
| <b>19322</b> | KROM | LES188CR      | 1         |

BATERIJA ZA SUDOPER  
SA FLEKSIBILNOM CIJEVI

| ŠIFRA VOKEL  | BOJA | ŠIFRA ARTIKLA | PAKIRANJE |
|--------------|------|---------------|-----------|
| <b>19323</b> | KROM | LEA176CR      | 1         |

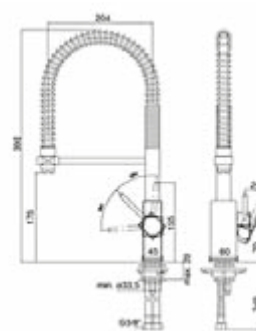

BATERIJA ZA SUDOPER

| ŠIFRA VOKEL  | BOJA | ŠIFRA ARTIKLA | PAKIRANJE |
|--------------|------|---------------|-----------|
| <b>19327</b> | KROM | LEA077CR      | 1         |

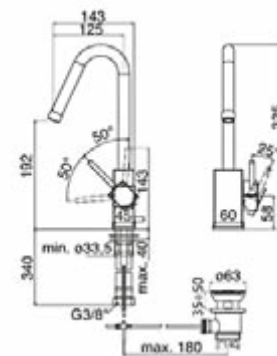

BATERIJA ZA SUDOPER

| ŠIFRA VOKEL  | BOJA | ŠIFRA ARTIKLA | PAKIRANJE |
|--------------|------|---------------|-----------|
| <b>19328</b> | KROM | LEA180CR      | 1         |

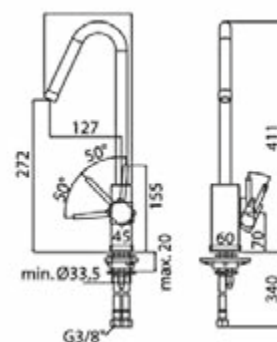

BATERIJA ZA SUDOPER

| ŠIFRA VOKEL  | BOJA | ŠIFRA ARTIKLA | PAKIRANJE |
|--------------|------|---------------|-----------|
| <b>19329</b> | KROM | LEA880CR      | 1         |

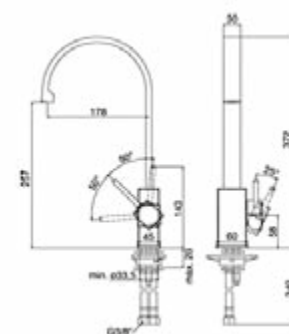

BATERIJA ZA BIDE

| ŠIFRA VOKEL  | BOJA | ŠIFRA ARTIKLA | PAKIRANJE |
|--------------|------|---------------|-----------|
| <b>19326</b> | KROM | LEA137CR      | 1         |

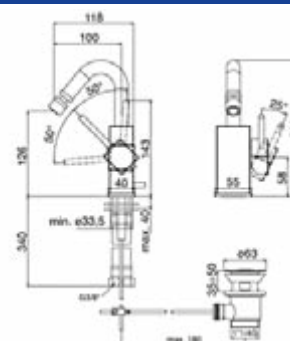



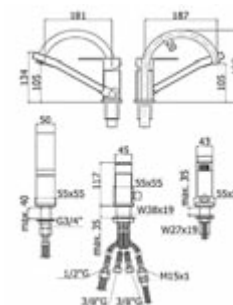

## BATERIJA ZA KADU – UGRADNA

| ŠIFRA VOKEL    | BOJA | ŠIFRA ARTIKLA | PAKIRANJE |
|----------------|------|---------------|-----------|
| <b>1102024</b> | KROM | LES040CR      | 1         |

## BATERIJA ZA TUŠ SA KRUTOM ŠIPKOM

| ŠIFRA VOKEL    | BOJA | ŠIFRA ARTIKLA | PAKIRANJE |
|----------------|------|---------------|-----------|
| <b>1102026</b> | KROM | ZCOL607CR     | 1         |

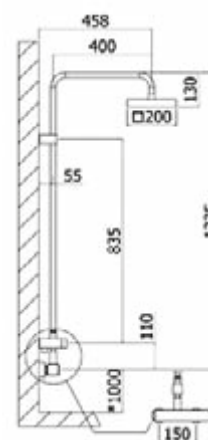

## BATERIJA ZA TUŠ SA FLEKSIBILNOM ŠIPKOM

| ŠIFRA VOKEL    | BOJA | ŠIFRA ARTIKLA | PAKIRANJE |
|----------------|------|---------------|-----------|
| <b>1102029</b> | KROM | ZCOL620CR     | 1         |

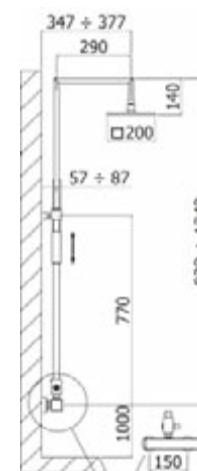

## KONZOLA ZA TUŠ SA RUČICOM I CRIJEVOM

| ŠIFRA VOKEL  | BOJA | ŠIFRA ARTIKLA | PAKIRANJE |
|--------------|------|---------------|-----------|
| <b>19334</b> | KROM | ZSAL078CR     | 1         |







JEDNORUČNE BATERIJE  
BERRY



## BATERIJA ZA UMIVAONIK

| ŠIFRA VOKEL    | BOJA | ŠIFRA ARTIKLA | PAKIRANJE |
|----------------|------|---------------|-----------|
| <b>1121001</b> | KROM | BR075CR       | 1         |

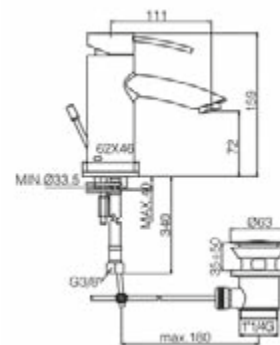

## BATERIJA ZA BIDE

| ŠIFRA VOKEL    | BOJA | ŠIFRA ARTIKLA | PAKIRANJE |
|----------------|------|---------------|-----------|
| <b>1121002</b> | KROM | BR135CR       | 1         |

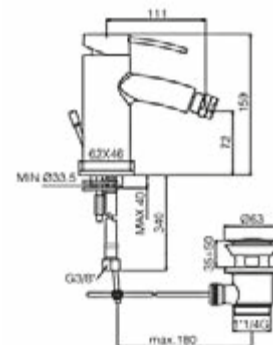

## BATERIJA ZA KADU

| ŠIFRA VOKEL    | BOJA | ŠIFRA ARTIKLA | PAKIRANJE |
|----------------|------|---------------|-----------|
| <b>1121003</b> | KROM | BR026CR       | 1         |

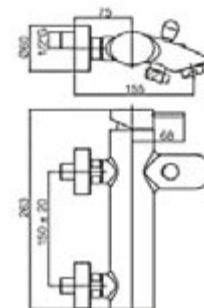

## BATERIJA ZA TUŠ

| ŠIFRA VOKEL    | BOJA | ŠIFRA ARTIKLA | PAKIRANJE |
|----------------|------|---------------|-----------|
| <b>1121004</b> | KROM | BR168DCR      | 1         |
| <b>1121018</b> | KROM | BR168CR       | 1         |

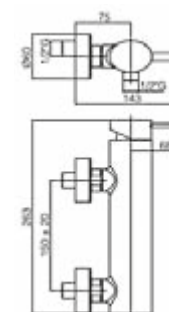

## BATERIJA ZA UMIVAONIK

| ŠIFRA VOKEL    | BOJA | ŠIFRA ARTIKLA | PAKIRANJE |
|----------------|------|---------------|-----------|
| <b>1121005</b> | KROM | BR085CR       | 1         |



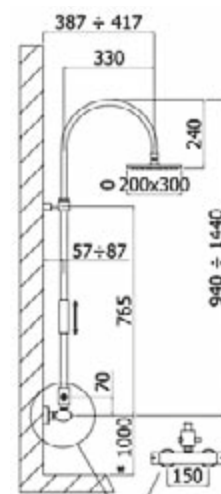

BATERIJA ZA TUŠ  
SA KRUTOM ŠIPKOM

| ŠIFRA VOKEL | BOJA | ŠIFRA ARTIKLA | PAKIRANJE |
|-------------|------|---------------|-----------|
| 1121006     | KROM | ZCOL710CR     | 1         |

KONZOLA ZA TUŠ  
SA RUČICOM I CRIJEVOM

| ŠIFRA VOKEL | BOJA | ŠIFRA ARTIKLA | PAKIRANJE |
|-------------|------|---------------|-----------|
| 1121007     | KROM | ZSAL102CR     | 1         |



KONZOLA ZA TUŠ

| ŠIFRA VOKEL | BOJA | ŠIFRA ARTIKLA | PAKIRANJE |
|-------------|------|---------------|-----------|
| 1121008     | KROM | ZSAL103CR     | 1         |



## BATERIJA ZA SUDOPER

| ŠIFRA VOKEL    | BOJA | ŠIFRA ARTIKLA | PAKIRANJE |
|----------------|------|---------------|-----------|
| <b>1121009</b> | KROM | BR180CR       | 1         |

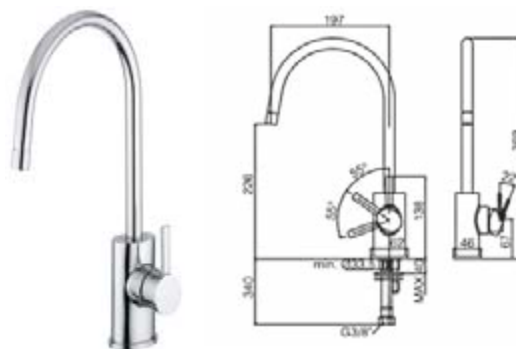

## BATERIJA ZA UMIVAONIK

| ŠIFRA VOKEL    | BOJA | ŠIFRA ARTIKLA | PAKIRANJE |
|----------------|------|---------------|-----------|
| <b>1121010</b> | KROM | BR077CR       | 1         |

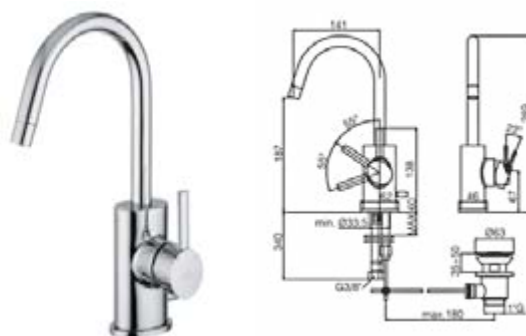

## BATERIJA ZA UMIVAONIK-UGRADNA

| ŠIFRA VOKEL    | BOJA | ŠIFRA ARTIKLA | PAKIRANJE |
|----------------|------|---------------|-----------|
| <b>1121011</b> | KROM | BR006CR       | 1         |



## IZLJEVNA CIJEV ZA BATERIJU BR006CR

| ŠIFRA VOKEL    | BOJA | ŠIFRA ARTIKLA | PAKIRANJE |
|----------------|------|---------------|-----------|
| <b>1121012</b> | KROM | ZCANA098CR    | 1         |

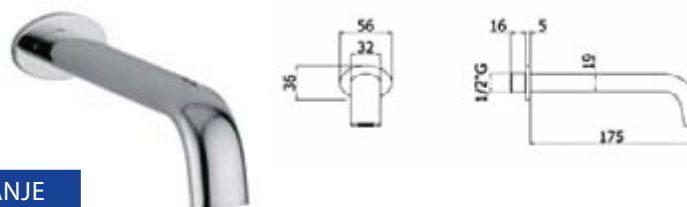

## BATERIJA ZA KADU - UGRADNA

| ŠIFRA VOKEL    | BOJA | ŠIFRA ARTIKLA | PAKIRANJE |
|----------------|------|---------------|-----------|
| <b>1121013</b> | KROM | BR040CR       | 1         |



## PODŽBUKNA BATERIJA ZA TUŠ

| ŠIFRA VOKEL    | BOJA | ŠIFRA ARTIKLA | PAKIRANJE |
|----------------|------|---------------|-----------|
| <b>1121014</b> | KROM | BR010CR       | 1         |

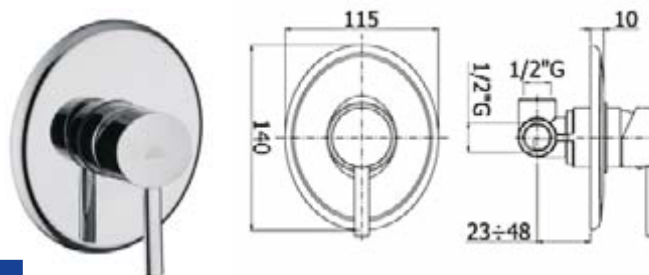

## PODŽBUKNA BATERIJA ZA KADU

| ŠIFRA VOKEL    | BOJA | ŠIFRA ARTIKLA | PAKIRANJE |
|----------------|------|---------------|-----------|
| <b>1121015</b> | KROM | BR015CR       | 1         |

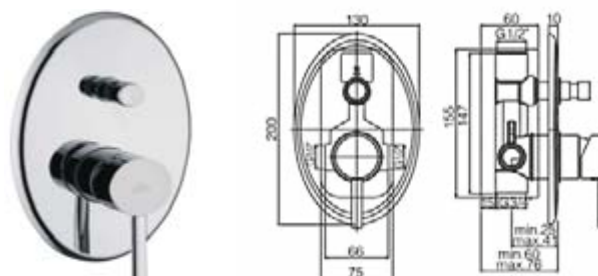

## IZLJEV ZA TUŠ - 300 mm

| ŠIFRA VOKEL    | BOJA | ŠIFRA ARTIKLA | PAKIRANJE |
|----------------|------|---------------|-----------|
| <b>0508036</b> | KROM | ZSOF035CR     | 1         |



## IZLJEV ZA TUŠ - 350 mm

| ŠIFRA VOKEL    | BOJA | ŠIFRA ARTIKLA | PAKIRANJE |
|----------------|------|---------------|-----------|
| <b>0508038</b> | KROM | ZSOF063CR     | 1         |



## OKRUGLA TUŠ RUŽA Ø 225 mm

| ŠIFRA VOKEL    | BOJA | ŠIFRA ARTIKLA | PAKIRANJE |
|----------------|------|---------------|-----------|
| <b>0508053</b> | KROM | ZSOF074CR     | 1         |



## KVADRATNA TUŠ RUŽA 200x200 mm

| ŠIFRA VOKEL    | BOJA | ŠIFRA ARTIKLA | PAKIRANJE |
|----------------|------|---------------|-----------|
| <b>0508052</b> | KROM | ZSOF075CR     | 1         |







## JEDNORUČNE BATERIJE CANDY



## BATERIJA ZA UMIVAONIK

| ŠIFRA VOKEL    | BOJA | ŠIFRA ARTIKLA | PAKIRANJE |
|----------------|------|---------------|-----------|
| <b>1159001</b> | KROM | CA075CR       | 1         |



## BATERIJA ZA BIDE

| ŠIFRA VOKEL    | BOJA | ŠIFRA ARTIKLA | PAKIRANJE |
|----------------|------|---------------|-----------|
| <b>1159002</b> | KROM | CA135CR       | 1         |



## BATERIJA ZA KADU

| ŠIFRA VOKEL    | BOJA | ŠIFRA ARTIKLA | PAKIRANJE |
|----------------|------|---------------|-----------|
| <b>1159004</b> | KROM | CA023CR       | 1         |

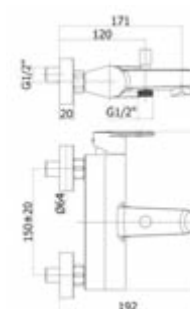

## BATERIJA ZA TUŠ

| ŠIFRA VOKEL    | BOJA | ŠIFRA ARTIKLA | PAKIRANJE |
|----------------|------|---------------|-----------|
| <b>1159005</b> | KROM | CA168DCR      | 1         |
| <b>1159011</b> | KROM | CA168RCR      | 1         |

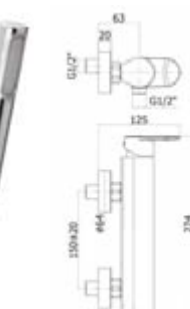

## BATERIJA ZA KUHINJU

| ŠIFRA VOKEL    | BOJA | ŠIFRA ARTIKLA | PAKIRANJE |
|----------------|------|---------------|-----------|
| <b>1159003</b> | KROM | CA085CR       | 1         |





TUŠ BLOK S TUŠ RUČICOM, TUŠ RUŽOM,  
TUŠ CRIJEVOM I PREBACIVAČEM

| ŠIFRA VOKEL    | BOJA | ŠIFRA ARTIKLA | PAKIRANJE |
|----------------|------|---------------|-----------|
| <b>0508063</b> | KROM | ZCOL680CR     | 1         |

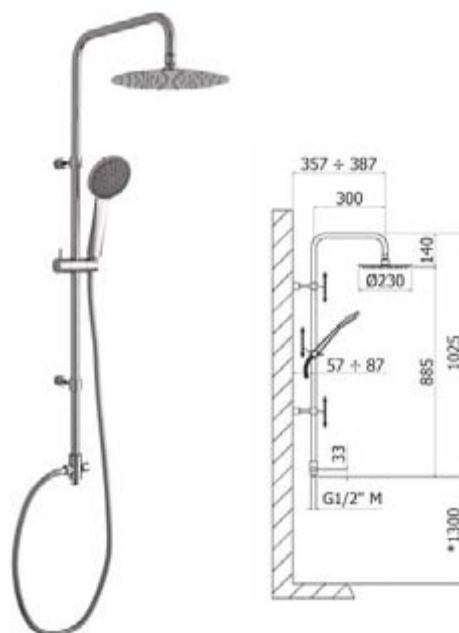

FLEKSIBILNO CRIJEVO 60 cm  
ZA SPOJ TUŠ BLOKA

| ŠIFRA VOKEL    | BOJA | ŠIFRA ARTIKLA | PAKIRANJE |
|----------------|------|---------------|-----------|
| <b>0508064</b> | KROM | ZFLO032CR     | 1         |





## JEDNORUČNE BATERIJE SLY





## BATERIJA ZA UMIVAONIK

| ŠIFRA VOKEL    | BOJA | ŠIFRA ARTIKLA | PAKIRANJE |
|----------------|------|---------------|-----------|
| <b>1137001</b> | KROM | SY075CR       | 1         |

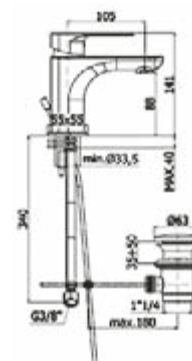

## BATERIJA ZA BIDE

| ŠIFRA VOKEL    | BOJA | ŠIFRA ARTIKLA | PAKIRANJE |
|----------------|------|---------------|-----------|
| <b>1137002</b> | KROM | SY135CR       | 1         |

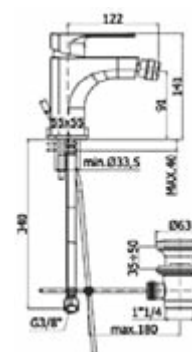

## BATERIJA ZA KADU

| ŠIFRA VOKEL    | BOJA | ŠIFRA ARTIKLA | PAKIRANJE |
|----------------|------|---------------|-----------|
| <b>1137003</b> | KROM | SY023CR       | 1         |

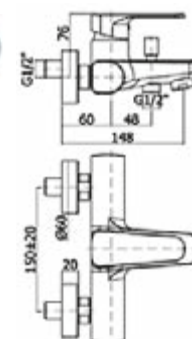

## BATERIJA ZA TUŠ

| ŠIFRA VOKEL    | BOJA | ŠIFRA ARTIKLA | PAKIRANJE |
|----------------|------|---------------|-----------|
| <b>1137004</b> | KROM | SY168DCR      | 1         |

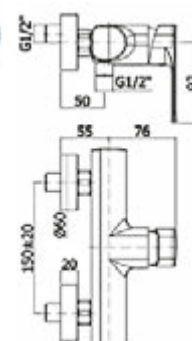

## PODŽBUKNA BATERIJA ZA TUŠ

| ŠIFRA VOKEL    | BOJA | ŠIFRA ARTIKLA | PAKIRANJE |
|----------------|------|---------------|-----------|
| <b>1137005</b> | KROM | SY010CR       | 1         |

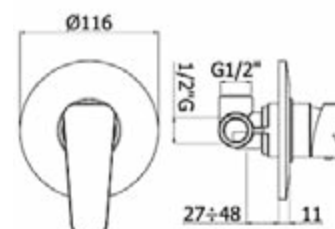

## PODŽBUKNA BATERIJA ZA KADU

| ŠIFRA VOKEL    | BOJA | ŠIFRA ARTIKLA | PAKIRANJE |
|----------------|------|---------------|-----------|
| <b>1137006</b> | KROM | SY015CR       | 1         |

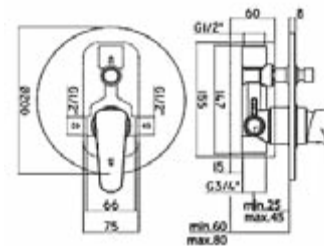

## BATERIJA ZA KUHINJU SA TUŠEM

| ŠIFRA VOKEL    | BOJA | ŠIFRA ARTIKLA | PAKIRANJE |
|----------------|------|---------------|-----------|
| <b>1137007</b> | KROM | SY185CR       | 1         |

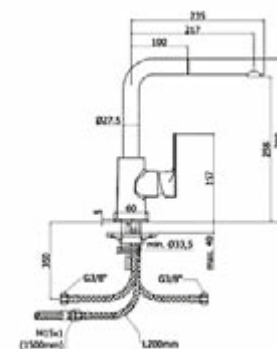

## BATERIJA ZA KUHINJU SA REGULACIJSKIM TUŠEM

| ŠIFRA VOKEL    | BOJA | ŠIFRA ARTIKLA | PAKIRANJE |
|----------------|------|---------------|-----------|
| <b>1137008</b> | KROM | SY285CR       | 1         |

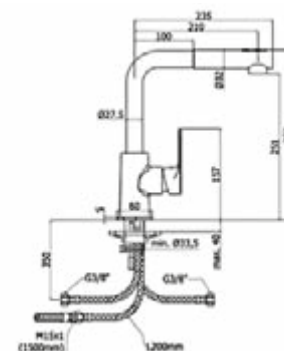

## BATERIJA ZA KUHINJU

| ŠIFRA VOKEL    | BOJA | ŠIFRA ARTIKLA | PAKIRANJE |
|----------------|------|---------------|-----------|
| <b>1137009</b> | KROM | SY180CR       | 1         |

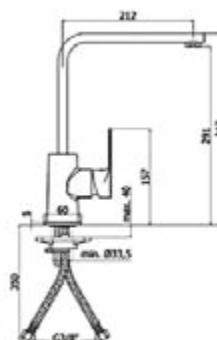

## BATERIJA ZA KUHINJU

| ŠIFRA VOKEL    | BOJA | ŠIFRA ARTIKLA | PAKIRANJE |
|----------------|------|---------------|-----------|
| <b>1137010</b> | KROM | SY181CR       | 1         |

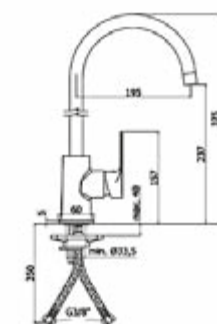



## JEDNORUČNE BATERIJE BIRILLO



## BATERIJA ZA UMIVAONIK

| ŠIFRA VOKEL  | BOJA | ŠIFRA ARTIKLA | PAKIRANJE |
|--------------|------|---------------|-----------|
| <b>19263</b> | KROM | BI075CR       | 1         |

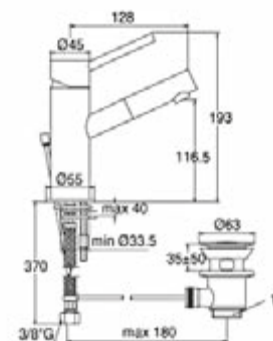

## BATERIJA ZA BIDE

| ŠIFRA VOKEL  | BOJA | ŠIFRA ARTIKLA | PAKIRANJE |
|--------------|------|---------------|-----------|
| <b>19265</b> | KROM | BI135CR       | 1         |

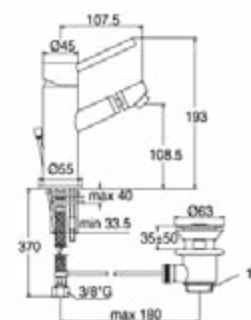

## BATERIJA ZA KUHINJU USADNA

| ŠIFRA VOKEL  | BOJA | ŠIFRA ARTIKLA | PAKIRANJE |
|--------------|------|---------------|-----------|
| <b>19267</b> | KROM | BI182CR       | 1         |

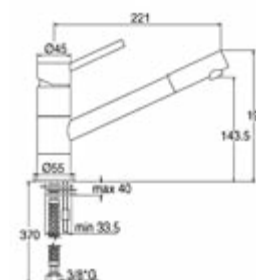

## BATERIJA ZA TUŠ

| ŠIFRA VOKEL  | BOJA | ŠIFRA ARTIKLA | PAKIRANJE |
|--------------|------|---------------|-----------|
| <b>19138</b> | KROM | BI168DCR      | 1         |

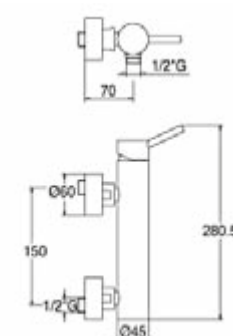

## BATERIJA ZA KADU

| ŠIFRA VOKEL  | BOJA | ŠIFRA ARTIKLA | PAKIRANJE |
|--------------|------|---------------|-----------|
| <b>19266</b> | KROM | BI026CR       | 1         |

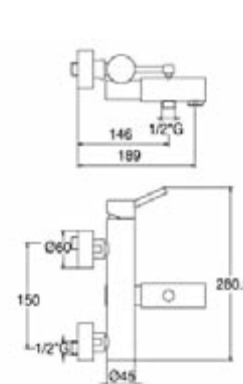

## BATERIJA ZA UMIVAONIK

| ŠIFRA VOKEL | BOJA | ŠIFRA ARTIKLA | PAKIRANJE |
|-------------|------|---------------|-----------|
| 19273       | KROM | DU075CR       | 1         |

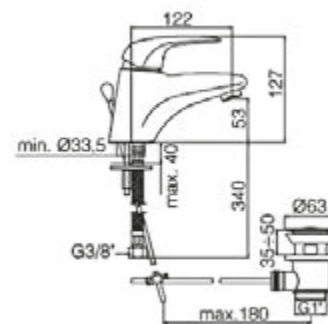

## BATERIJA ZA BIDE

| ŠIFRA VOKEL | BOJA | ŠIFRA ARTIKLA | PAKIRANJE |
|-------------|------|---------------|-----------|
| 19275       | KROM | DU135CR       | 1         |

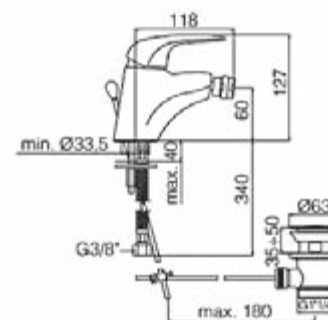

## BATERIJA ZA TUŠ

| ŠIFRA VOKEL | BOJA | ŠIFRA ARTIKLA | PAKIRANJE |
|-------------|------|---------------|-----------|
| 19277       | KROM | DU168DCR      | 1         |

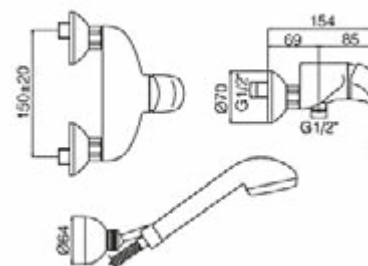

## BATERIJA ZA KADU

| ŠIFRA VOKEL | BOJA | ŠIFRA ARTIKLA | PAKIRANJE |
|-------------|------|---------------|-----------|
| 19050       | KROM | DU026CR       | 1         |

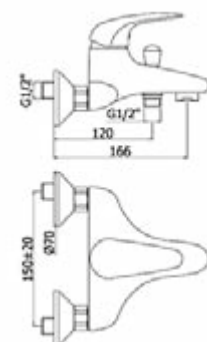

## BATERIJA ZA FRIZERSKI UMIVAONIK

| ŠIFRA VOKEL | BOJA | ŠIFRA ARTIKLA | PAKIRANJE |
|-------------|------|---------------|-----------|
| 19274       | KROM | DU087CR       | 1         |

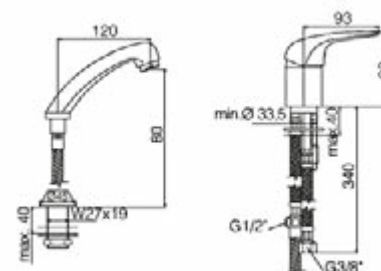



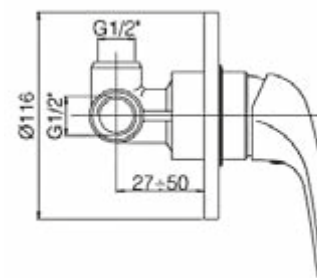

## PODŽBUKNA BATERIJA ZA TUŠ

| ŠIFRA VOKEL | BOJA | ŠIFRA ARTIKLA | PAKIRANJE |
|-------------|------|---------------|-----------|
| 19268       | KROM | DU010CR       | 1         |

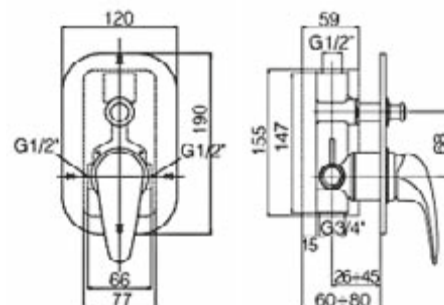

## PODŽBUKNA BATERIJA ZA KADU

| ŠIFRA VOKEL | BOJA | ŠIFRA ARTIKLA | PAKIRANJE |
|-------------|------|---------------|-----------|
| 19269       | KROM | DU014CR       | 1         |

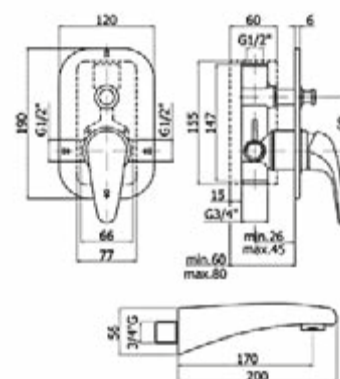

## BATERIJA ZA TUŠ PODŽBUKNA-SA IZLJEVOM I TUŠ RUČICOM

| ŠIFRA VOKEL | BOJA | ŠIFRA ARTIKLA | PAKIRANJE |
|-------------|------|---------------|-----------|
| 19270       | KROM | DU016CR       | 1         |

## BATERIJA ZA KADU UGRADNA

| ŠIFRA VOKEL | BOJA | ŠIFRA ARTIKLA | PAKIRANJE |
|-------------|------|---------------|-----------|
| 19272       | KROM | DU040CR       | 1         |

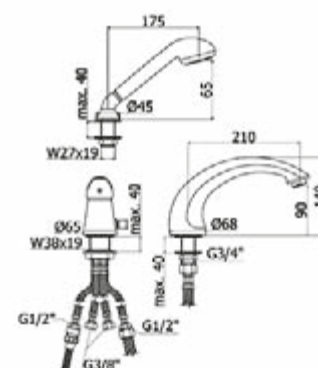

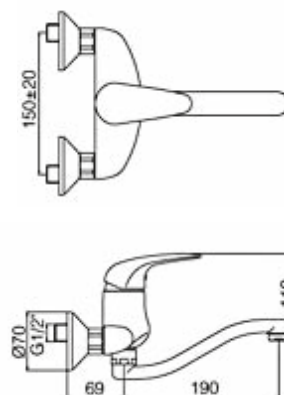

BATERIJA ZA KUHINJU

| ŠIFRA VOKEL  | BOJA | ŠIFRA ARTIKLA | PAKIRANJE |
|--------------|------|---------------|-----------|
| <b>19276</b> | KROM | DU161CR       | 1         |

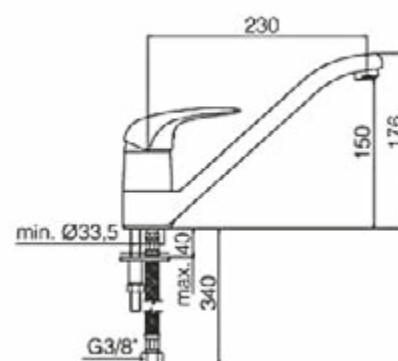

BATERIJA ZA KUHINJU

| ŠIFRA VOKEL  | BOJA | ŠIFRA ARTIKLA | PAKIRANJE |
|--------------|------|---------------|-----------|
| <b>19278</b> | KROM | DU182CR       | 1         |

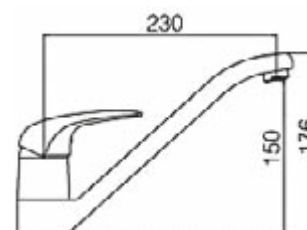

BATERIJA ZA KUHINJU  
SA 3 CIJEVI

| ŠIFRA VOKEL  | BOJA | ŠIFRA ARTIKLA | PAKIRANJE |
|--------------|------|---------------|-----------|
| <b>19087</b> | KROM | DU195CR       | 1         |

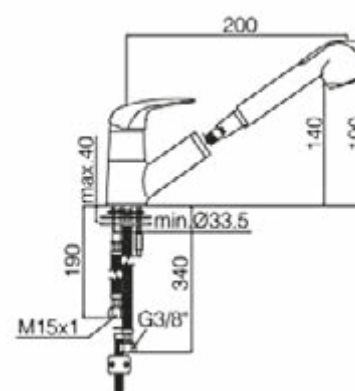

BATERIJA ZA KUHINJU  
STUŠEM

| ŠIFRA VOKEL  | BOJA | ŠIFRA ARTIKLA | PAKIRANJE |
|--------------|------|---------------|-----------|
| <b>19279</b> | KROM | DU183CR       | 1         |

BATERIJA ZA KUHINJU  
ZGLOBNA

| ŠIFRA VOKEL | BOJA | ŠIFRA ARTIKLA | PAKIRANJE |
|-------------|------|---------------|-----------|
| 19283       | KROM | DU189CR       | 1         |

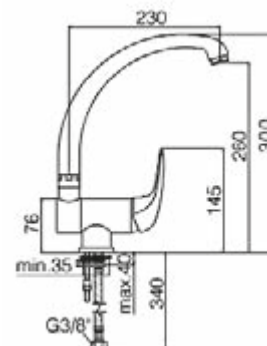

BATERIJA ZA KUHINJU  
HIGIJENSKA

| ŠIFRA VOKEL | BOJA | ŠIFRA ARTIKLA | PAKIRANJE |
|-------------|------|---------------|-----------|
| 19281       | KROM | DU302CR       | 1         |

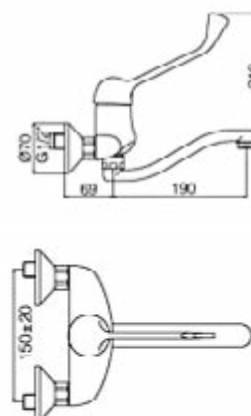

BATERIJA ZA KUHINJU  
HIGIJENSKA

| ŠIFRA VOKEL | BOJA | ŠIFRA ARTIKLA | PAKIRANJE |
|-------------|------|---------------|-----------|
| 19282       | KROM | DU303CR       | 1         |

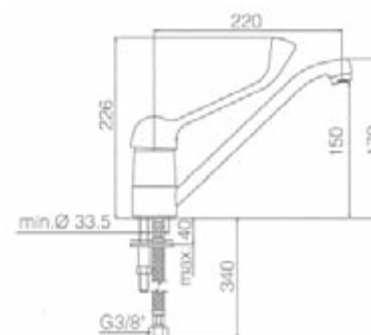

BATERIJA ZA UMIVAONIK  
HIGIJENSKA

| ŠIFRA VOKEL | BOJA | ŠIFRA ARTIKLA | PAKIRANJE |
|-------------|------|---------------|-----------|
| 19280       | KROM | DU305CR       | 1         |

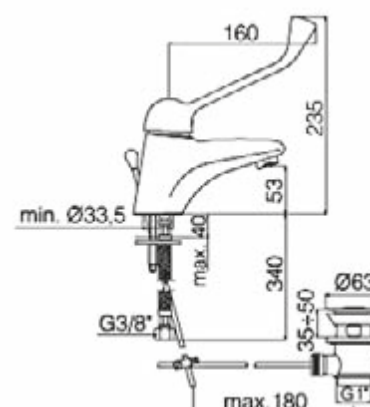



## DVORUČNE BATERIJE BELINDA



## BATERIJA ZA KADU

| ŠIFRA VOKEL | BOJA   | ŠIFRA ARTIKLA | PAKIRANJE |
|-------------|--------|---------------|-----------|
| 19252       | BRONZA | FBL023BR      | 1         |
| 0429048     | KROM   | FBL023CR      | 1         |

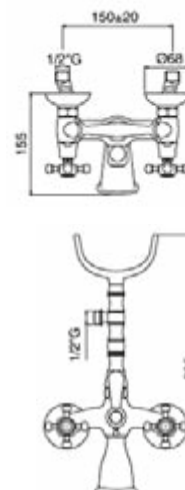

## BATERIJA ZA BIDE

| ŠIFRA VOKEL | BOJA   | ŠIFRA ARTIKLA | PAKIRANJE |
|-------------|--------|---------------|-----------|
| 19262       | BRONZA | FBL135BR      | 1         |
| 0429049     | KROM   | FBL135CR      | 1         |

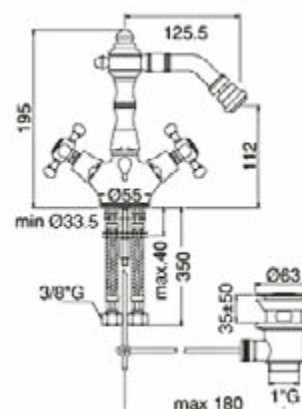

## BATERIJA ZA UMIVAONIK

| ŠIFRA VOKEL | BOJA   | ŠIFRA ARTIKLA | PAKIRANJE |
|-------------|--------|---------------|-----------|
| 19253       | BRONZA | FBL075BR      | 1         |
| 0429047     | KROM   | FBL075CR      | 1         |

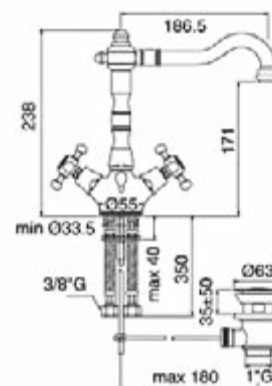

## BATERIJA ZA KUHINJU USADNA

| ŠIFRA VOKEL | BOJA   | ŠIFRA ARTIKLA | PAKIRANJE |
|-------------|--------|---------------|-----------|
| 19254       | BRONZA | FBL180BR      | 1         |
| 0429050     | KROM   | FBL180CR      | 1         |

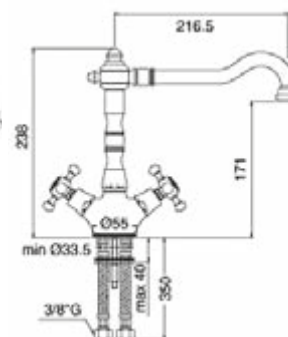



ČAŠA S DRŽAČEM

| ŠIFRA VOKEL | BOJA   | ŠIFRA ARTIKLA | PAKIRANJE |
|-------------|--------|---------------|-----------|
| 19260       | BRONZA | BL001BR       | 1         |



WC ČETKA S DRŽAČEM

| ŠIFRA VOKEL | BOJA   | ŠIFRA ARTIKLA | PAKIRANJE |
|-------------|--------|---------------|-----------|
| 19261       | BRONZA | BL002BR       | 1         |



SAPUNICA S DRŽAČEM

| ŠIFRA VOKEL | BOJA   | ŠIFRA ARTIKLA | PAKIRANJE |
|-------------|--------|---------------|-----------|
| 19259       | BRONZA | BL003BR       | 1         |



VJEŠALICA

| ŠIFRA VOKEL | BOJA   | ŠIFRA ARTIKLA | PAKIRANJE |
|-------------|--------|---------------|-----------|
| 19258       | BRONZA | BL007BR       | 1         |



DRŽAČ RUČNIKA

| ŠIFRA VOKEL | BOJA   | ŠIFRA ARTIKLA | PAKIRANJE |
|-------------|--------|---------------|-----------|
| 19256       | BRONZA | BL005BR       | 1         |







## JEDNORUČNE BATERIJE FYNE



## BATERIJA ZA UMIVAONIK

| ŠIFRA VOKEL    | BOJA | ŠIFRA ARTIKLA | PAKIRANJE |
|----------------|------|---------------|-----------|
| <b>1138001</b> | KROM | FY075CR       | 1         |

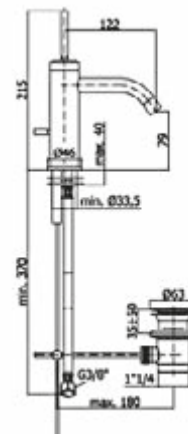

## BATERIJA ZA BIDE

| ŠIFRA VOKEL    | BOJA | ŠIFRA ARTIKLA | PAKIRANJE |
|----------------|------|---------------|-----------|
| <b>1138002</b> | KROM | FY135CR       | 1         |

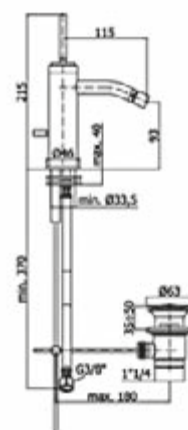

## BATERIJA ZA KADU

| ŠIFRA VOKEL    | BOJA | ŠIFRA ARTIKLA | PAKIRANJE |
|----------------|------|---------------|-----------|
| <b>1138003</b> | KROM | FY023CR       | 1         |

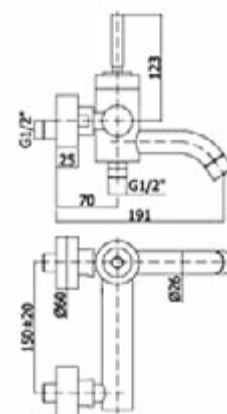

## BATERIJA ZA TUŠ

| ŠIFRA VOKEL    | BOJA | ŠIFRA ARTIKLA | PAKIRANJE |
|----------------|------|---------------|-----------|
| <b>1138004</b> | KROM | FY168DCR      | 1         |

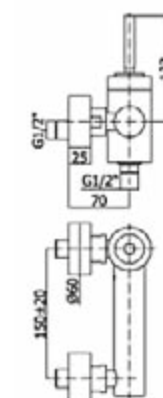

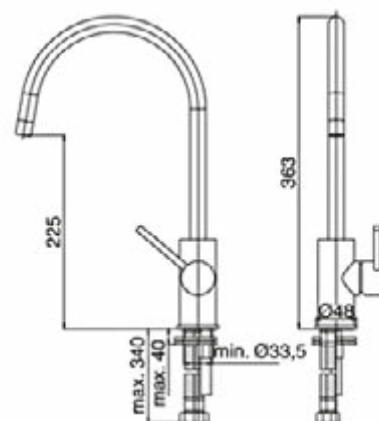

## BATERIJA ZA SUDOPER

| ŠIFRA VOKEL | BOJA | ŠIFRA ARTIKLA | PAKIRANJE |
|-------------|------|---------------|-----------|
| 1119001     | KROM | LIG180CR      | 1         |





### BATERIJA ZA KADU

| ŠIFRA VOKEL | BOJA | ŠIFRA ARTIKLA | PAKIRANJE |
|-------------|------|---------------|-----------|
| 19240       | KROM | APM3023CR     | 1         |



### BATERIJA ZA UMIVAONIK

| ŠIFRA VOKEL | BOJA | ŠIFRA ARTIKLA | PAKIRANJE |
|-------------|------|---------------|-----------|
| 19241       | KROM | AMP3075CR     | 1         |



### BATERIJA ZA BIDE

| ŠIFRA VOKEL | BOJA | ŠIFRA ARTIKLA | PAKIRANJE |
|-------------|------|---------------|-----------|
| 19242       | KROM | APM3135CR     | 1         |

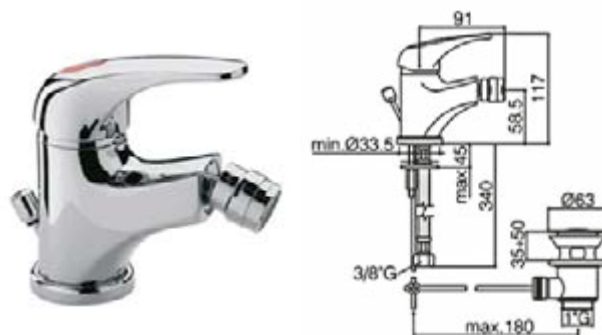

### BATERIJA ZA KUHINJU

| ŠIFRA VOKEL | BOJA | ŠIFRA ARTIKLA | PAKIRANJE |
|-------------|------|---------------|-----------|
| 19243       | KROM | APM3182CR     | 1         |

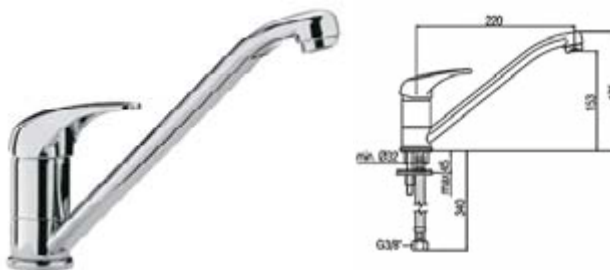

### BATERIJA ZA KUHINJU I UMIVAONIK

| ŠIFRA VOKEL | BOJA | ŠIFRA ARTIKLA | PAKIRANJE |
|-------------|------|---------------|-----------|
| 19244       | KROM | APM3164CR     | 1         |



BATERIJA ZA KADU  
TERMOSTATSKA

| ŠIFRA VOKEL | BOJA | ŠIFRA ARTIKLA | PAKIRANJE |
|-------------|------|---------------|-----------|
| 19086       | KROM | EQT023CR      | 1         |

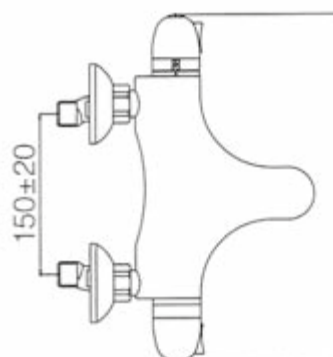
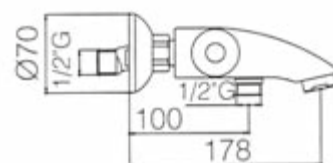
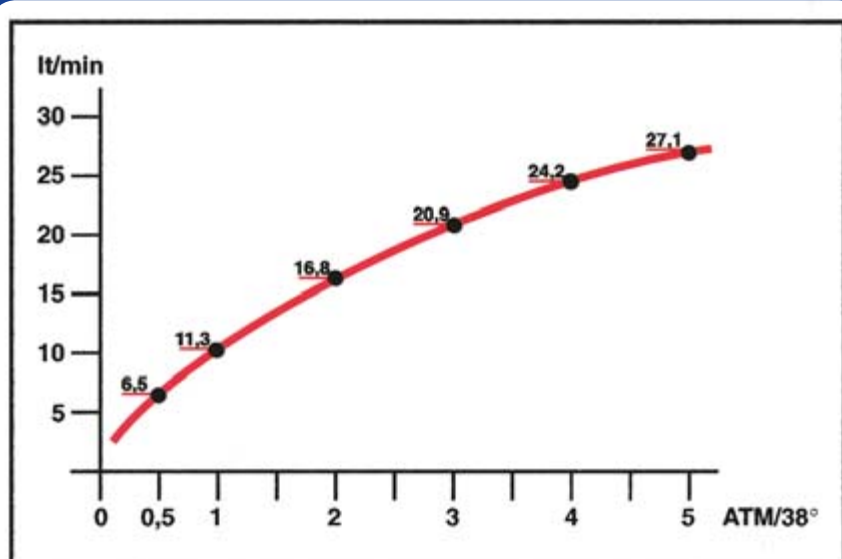
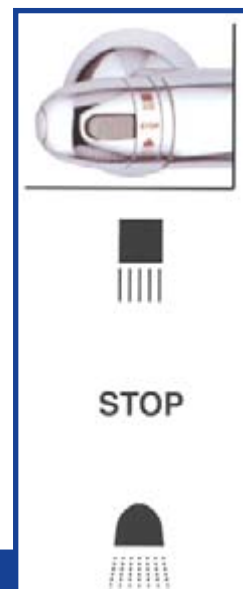

#### IZLJEV ZA KADU

| ŠIFRA VOKEL  | BOJA | ŠIFRA ARTIKLA | PAKIRANJE |
|--------------|------|---------------|-----------|
| <b>19286</b> | KROM | ZBOC013CR     | 1         |



#### PRIKLJUČAK ZA TUŠ

| ŠIFRA VOKEL  | BOJA | ŠIFRA ARTIKLA | PAKIRANJE |
|--------------|------|---------------|-----------|
| <b>19131</b> | KROM | ZACC130CR     | 1         |



#### PRIKLJUČAK ZA TUŠ

| ŠIFRA VOKEL    | BOJA | ŠIFRA ARTIKLA | PAKIRANJE |
|----------------|------|---------------|-----------|
| <b>0508045</b> | KROM | ZACC238CR     | 1         |



#### RUČICA ZA TUŠ - LEVEL

| ŠIFRA VOKEL    | BOJA | ŠIFRA ARTIKLA | PAKIRANJE |
|----------------|------|---------------|-----------|
| <b>0508054</b> | KROM | ZDOC054CR     | 1         |



#### RUČICA ZA TUŠ - BERRY

| ŠIFRA VOKEL    | BOJA | ŠIFRA ARTIKLA | PAKIRANJE |
|----------------|------|---------------|-----------|
| <b>0508055</b> | KROM | ZDOC078CR     | 1         |



#### RUČICA ZA TUŠ SA PREKIDAČEM

| ŠIFRA VOKEL    | BOJA | ŠIFRA ARTIKLA | PAKIRANJE |
|----------------|------|---------------|-----------|
| <b>0508056</b> | KROM | ZDOC002CR     | 1         |



FLEKSIBILNO CRIJEVO ZA KUHINJSKU BATERIJU  
1/2" - M15x1/L=1500 mm

| ŠIFRA VOKEL    | BOJA | ŠIFRA ARTIKLA | PAKIRANJE |
|----------------|------|---------------|-----------|
| <b>0508057</b> | KROM | ZFLO009CR     | 1         |



FLEKSIBILNO CRIJEVO ZA KUHINJSKU BATERIJU  
1/2" - M15x1/L=1500 mm

| ŠIFRA VOKEL    | BOJA | ŠIFRA ARTIKLA | PAKIRANJE |
|----------------|------|---------------|-----------|
| <b>0508065</b> | KROM | ZFLO011CR     | 1         |



FLEKSIBILNO TUŠ CRIJEVO  
3/8" - M15x1/L=1500 mm

| ŠIFRA VOKEL    | BOJA | ŠIFRA ARTIKLA | PAKIRANJE |
|----------------|------|---------------|-----------|
| <b>0508048</b> | KROM | ZFLO010CR     | 1         |



FLEKSIBILNO TUŠ CRIJEVO-ZA SPOJ TUŠ BLOKA  
1/2" x 1/2" L=600 mm

| ŠIFRA VOKEL    | BOJA | ŠIFRA ARTIKLA | PAKIRANJE |
|----------------|------|---------------|-----------|
| <b>0508064</b> | KROM | ZFLO032CR     | 1         |



FLEKSIBILNO TUŠ CRIJEVO-EXTRA  
1/2" x 1/2" L=1500 mm

| ŠIFRA VOKEL    | BOJA | ŠIFRA ARTIKLA | PAKIRANJE |
|----------------|------|---------------|-----------|
| <b>0508015</b> | KROM | ZFLO001CR     | 1         |



TUŠ IZLJEV  
Ø24 mm x L=120 mm

| ŠIFRA VOKEL    | BOJA | ŠIFRA ARTIKLA | PAKIRANJE |
|----------------|------|---------------|-----------|
| <b>0508061</b> | KROM | ZSOF064CR     | 1         |



Ø24 mm x L=200 mm

| ŠIFRA VOKEL    | BOJA | ŠIFRA ARTIKLA | PAKIRANJE |
|----------------|------|---------------|-----------|
| <b>0508062</b> | KROM | ZSOF065CR     | 1         |



BATERIJA ZA TUŠ  
SA TUŠ RUŽOM Ø230 mm, CRIJEVOM I RUČICOM

| ŠIFRA VOKEL    | BOJA | ŠIFRA ARTIKLA | PAKIRANJE |
|----------------|------|---------------|-----------|
| <b>0508066</b> | KROM | ZCOL685CR     | 1         |



KONZOLA ZA TUŠ

| ŠIFRA VOKEL  | BOJA | ŠIFRA ARTIKLA | PAKIRANJE |
|--------------|------|---------------|-----------|
| <b>19135</b> | KROM | ZSAL022CR     | 1         |



KONZOLA ZA TUŠ

| ŠIFRA VOKEL  | BOJA | ŠIFRA ARTIKLA | PAKIRANJE |
|--------------|------|---------------|-----------|
| <b>19136</b> | KROM | ZSAL043CR     | 1         |



KONZOLA ZA TUŠ  
SA CRIJEVOM I RUČICOM

| ŠIFRA VOKEL  | BOJA | ŠIFRA ARTIKLA | PAKIRANJE |
|--------------|------|---------------|-----------|
| <b>19137</b> | KROM | ZSAL064CR     | 1         |



KONZOLA ZA TUŠ

| ŠIFRA VOKEL    | BOJA | ŠIFRA ARTIKLA | PAKIRANJE |
|----------------|------|---------------|-----------|
| <b>0508044</b> | KROM | ZSAL088CR     | 1         |



KONZOLA ZA TUŠ  
SA CRIJEVOM I RUČICOM

| ŠIFRA VOKEL  | BOJA | ŠIFRA ARTIKLA | PAKIRANJE |
|--------------|------|---------------|-----------|
| <b>19134</b> | KROM | ZSAL009CR     | 1         |



 **UNITAS**<sup>®</sup>

*Vokel*



[www.unitas.si](http://www.unitas.si)

■ Naša kvaliteta je potvrđena s certifikatima



Standard:  
 pr EN 817, SIST EN 200,  
 SIST EN 246, SIST EN 248

**Prestige** ■ Jednoručne baterije Prestige





BATERIJA ZA UMIVAONIK  
KOMPLET

| ŠIFRA VOKEL  | BOJA | ŠIFRA ARTIKLA | PAKIRANJE |
|--------------|------|---------------|-----------|
| <b>02462</b> | KROM | 00051         | 1         |

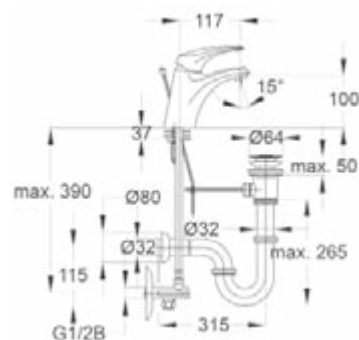

BATERIJA ZA UMIVAONIK  
KOMPLET

| ŠIFRA VOKEL  | BOJA | ŠIFRA ARTIKLA | PAKIRANJE |
|--------------|------|---------------|-----------|
| <b>02557</b> | KROM | 00055         | 1         |

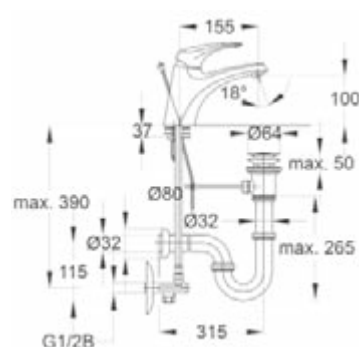

BATERIJA ZA KUHINJU  
S KUTNIM VENTILOM

| ŠIFRA VOKEL  | BOJA | ŠIFRA ARTIKLA | PAKIRANJE |
|--------------|------|---------------|-----------|
| <b>02468</b> | KROM | 00151         | 1         |



BATERIJA ZA KUHINJU  
SA 3 CIJEVI

| ŠIFRA VOKEL  | BOJA | ŠIFRA ARTIKLA | PAKIRANJE |
|--------------|------|---------------|-----------|
| <b>02465</b> | KROM | 01131         | 1         |





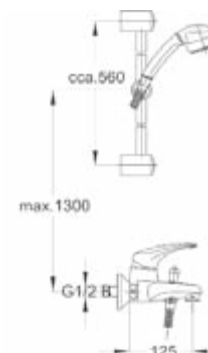

BATERIJA ZA KADU  
CRIJEVO ZA TUŠ, KONZOLA I MASAŽNI TUŠ

| ŠIFRA VOKEL  | BOJA | ŠIFRA ARTIKLA | PAKIRANJE |
|--------------|------|---------------|-----------|
| <b>02463</b> | KROM | 00352         | 1         |

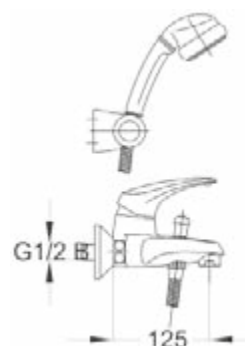

BATERIJA ZA KADU  
ZIDNI DRŽAČ, CRIJEVO ZA TUŠ I TUŠ RUČICA

| ŠIFRA VOKEL  | BOJA | ŠIFRA ARTIKLA | PAKIRANJE |
|--------------|------|---------------|-----------|
| <b>02559</b> | KROM | 00356         | 1         |

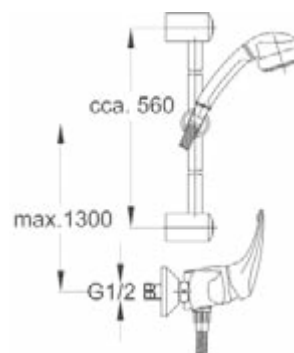

BATERIJA ZA TUŠ  
CRIJEVO ZA TUŠ, KONZOLA I MASAŽNI TUŠ

| ŠIFRA VOKEL  | BOJA | ŠIFRA ARTIKLA | PAKIRANJE |
|--------------|------|---------------|-----------|
| <b>02561</b> | KROM | 00451         | 1         |

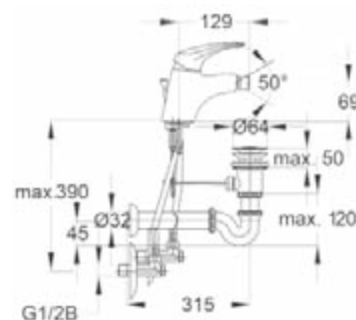

BATERIJA ZA BIDE  
KOMPLET

| ŠIFRA VOKEL  | BOJA | ŠIFRA ARTIKLA | PAKIRANJE |
|--------------|------|---------------|-----------|
| <b>02464</b> | KROM | 00551         | 1         |

Fresh  Jednoručne baterije Fresh





## JEDNORUČNE BATERIJE FRESH



BATERIJA ZA UMIVAONIK  
S GORNJIM DIJELOM SIFONA

| ŠIFRA VOKEL    | BOJA | ŠIFRA ARTIKLA | PAKIRANJE |
|----------------|------|---------------|-----------|
| <b>1131005</b> | KROM | 00038         | 1         |

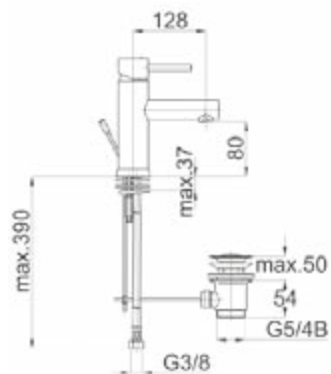

BATERIJA ZA KUHINJU  
SA TUŠEM NA IZVLAČENJE

| ŠIFRA VOKEL    | BOJA | ŠIFRA ARTIKLA | PAKIRANJE |
|----------------|------|---------------|-----------|
| <b>1131006</b> | KROM | 00137         | 1         |

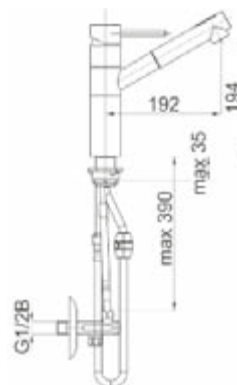

BATERIJA ZA KUHINJU  
FIKSNA

| ŠIFRA VOKEL    | BOJA | ŠIFRA ARTIKLA | PAKIRANJE |
|----------------|------|---------------|-----------|
| <b>1131004</b> | KROM | 00134         | 1         |

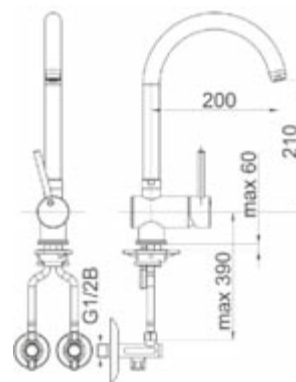

BATERIJA ZA KUHINJU  
FIKSNA SA 3 CIJEVI

| ŠIFRA VOKEL    | BOJA | ŠIFRA ARTIKLA | PAKIRANJE |
|----------------|------|---------------|-----------|
| <b>1131007</b> | KROM | 01137         | 1         |

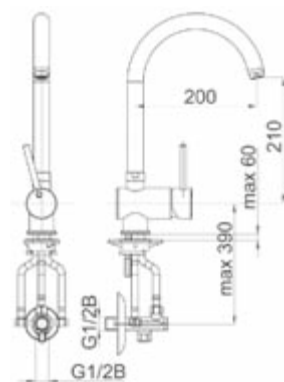



BATERIJA ZA KUHINJU  
PREKLOPNA SA 3 CIJEVI

| ŠIFRA VOKEL    | BOJA | ŠIFRA ARTIKLA | PAKIRANJE |
|----------------|------|---------------|-----------|
| <b>1131008</b> | KROM | 01138         | 1         |

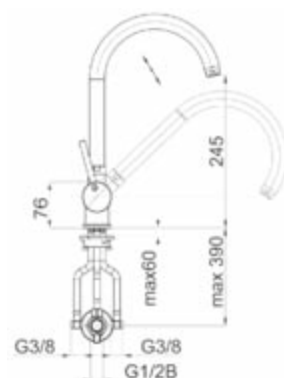

BATERIJA ZA KUHINJU  
PREKLOPNA

| ŠIFRA VOKEL    | BOJA | ŠIFRA ARTIKLA | PAKIRANJE |
|----------------|------|---------------|-----------|
| <b>1131001</b> | KROM | 00135         | 1         |

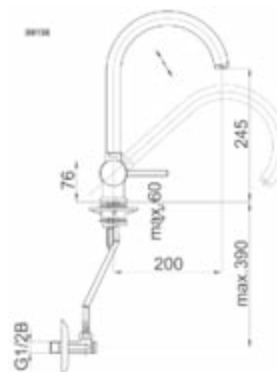

BATERIJA ZA KUHINJU  
S TUŠEM

| ŠIFRA VOKEL    | BOJA | ŠIFRA ARTIKLA | PAKIRANJE |
|----------------|------|---------------|-----------|
| <b>1131016</b> | KROM | 00138         | 1         |

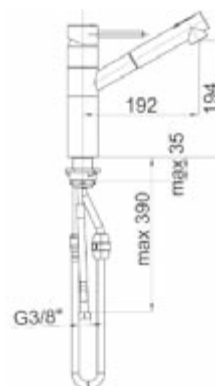

BATERIJA ZA KUHINJU  
TERMOSTATSKA

| ŠIFRA VOKEL    | BOJA | ŠIFRA ARTIKLA | PAKIRANJE |
|----------------|------|---------------|-----------|
| <b>1131012</b> | KROM | 00235         | 1         |

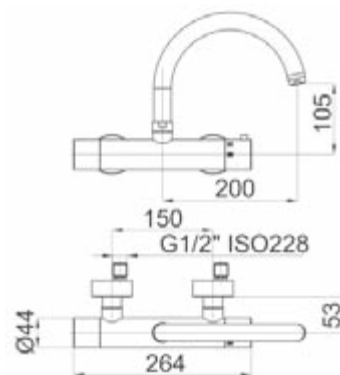



BATERIJA ZA UMIVAONIK

| ŠIFRA VOKEL    | BOJA | ŠIFRA ARTIKLA | PAKIRANJE |
|----------------|------|---------------|-----------|
| <b>1131013</b> | KROM | 00048         | 1         |
| <b>1131017</b> | KROM | 00041         | 1         |

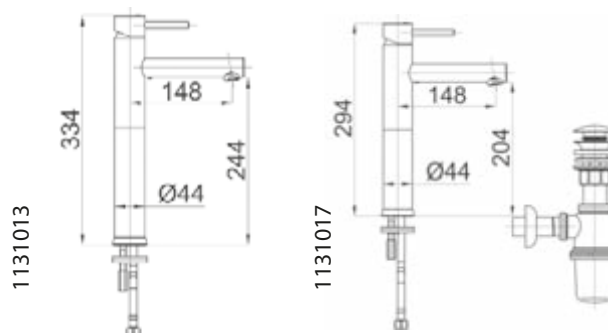

BATERIJA ZA UMIVAONIK  
ELEKTRONSKA - 230V

| ŠIFRA VOKEL    | BOJA | ŠIFRA ARTIKLA | PAKIRANJE |
|----------------|------|---------------|-----------|
| <b>1131028</b> | KROM | 09019         | 1         |

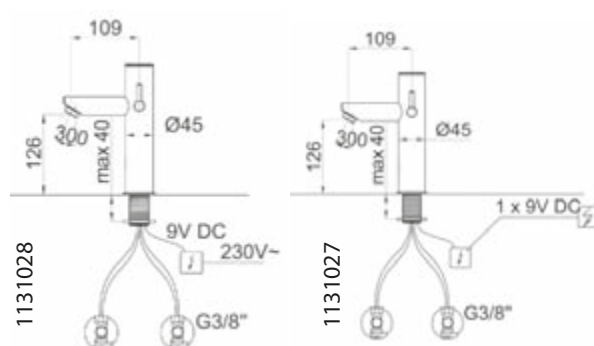

ELEKTRONSKA - 9V

| ŠIFRA VOKEL    | BOJA | ŠIFRA ARTIKLA | PAKIRANJE |
|----------------|------|---------------|-----------|
| <b>1131027</b> | KROM | 09018         | 1         |



BATERIJA ZA BIDE

| ŠIFRA VOKEL    | BOJA | ŠIFRA ARTIKLA | PAKIRANJE |
|----------------|------|---------------|-----------|
| <b>1131002</b> | KROM | 00536         | 1         |

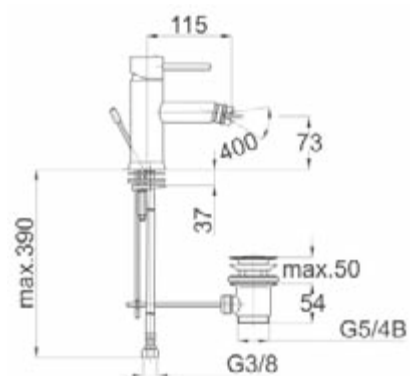

BATERIJA ZA TUŠ

| ŠIFRA VOKEL    | BOJA | ŠIFRA ARTIKLA | PAKIRANJE |
|----------------|------|---------------|-----------|
| <b>1131032</b> | KROM | 00434         | 1         |

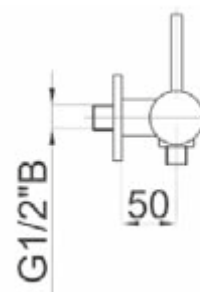





BATERIJA ZA KADU  
CRIJEVO ZA TUŠ, KONZOLA I TUŠ RUČICA

| ŠIFRA VOKEL    | BOJA | ŠIFRA ARTIKLA | PAKIRANJE |
|----------------|------|---------------|-----------|
| <b>1131003</b> | KROM | 00335         | 1         |

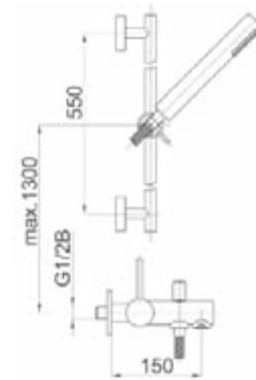

BATERIJA ZA TUŠ  
S CRIJEVOM, KONZOLOM I TUŠ RUČICOM

| ŠIFRA VOKEL    | BOJA | ŠIFRA ARTIKLA | PAKIRANJE |
|----------------|------|---------------|-----------|
| <b>1131009</b> | KROM | 00435         | 1         |

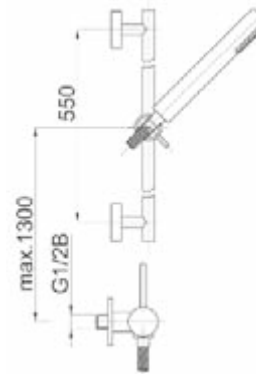

BATERIJA ZA TUŠ  
TERMOSTATSKA S TUŠ KONZOLOM

| ŠIFRA VOKEL    | BOJA | ŠIFRA ARTIKLA | PAKIRANJE |
|----------------|------|---------------|-----------|
| <b>1131011</b> | KROM | 00437         | 1         |

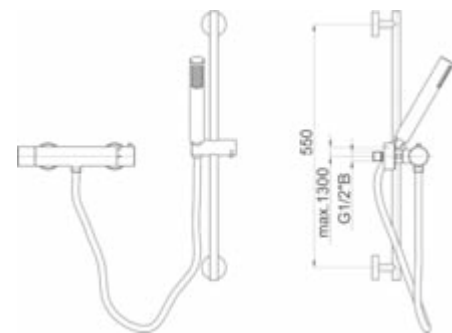

BATERIJA ZA KADU  
TERMOSTATSKA

| ŠIFRA VOKEL    | BOJA | ŠIFRA ARTIKLA | PAKIRANJE |
|----------------|------|---------------|-----------|
| <b>1131010</b> | KROM | 00336         | 1         |
| <b>1131018</b> | KROM | 00339         | 1         |

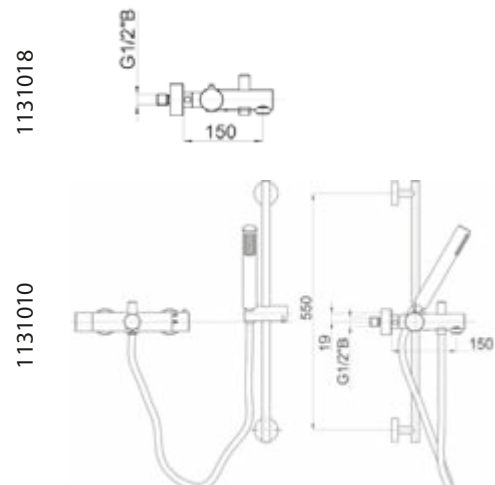



UGRADNA MJEŠALICA  
ZA TUŠ BATERIJU

| ŠIFRA VOKEL    | BOJA | ŠIFRA ARTIKLA | PAKIRANJE |
|----------------|------|---------------|-----------|
| <b>1134017</b> | -    | 00367         | 1         |

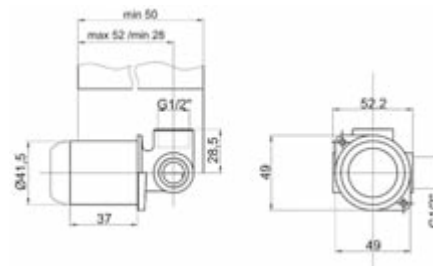

UGRADNA MJEŠALICA  
ZA KADU ILI 2 TUŠ BATERIJE

| ŠIFRA VOKEL    | BOJA | ŠIFRA ARTIKLA | PAKIRANJE |
|----------------|------|---------------|-----------|
| <b>1134018</b> | -    | 00368         | 1         |

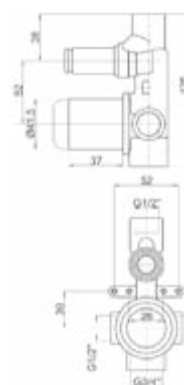

PODŽBUKNA BATERIJA ZA TUŠ

| ŠIFRA VOKEL    | BOJA | ŠIFRA ARTIKLA | PAKIRANJE |
|----------------|------|---------------|-----------|
| <b>1131014</b> | KROM | 12259         | 1         |



PODŽBUKNA BATERIJA ZA KADU ILI 2 TUŠA

| ŠIFRA VOKEL    | BOJA | ŠIFRA ARTIKLA | PAKIRANJE |
|----------------|------|---------------|-----------|
| <b>1131015</b> | KROM | 12260         | 1         |



### SET S KONZOLOM

| ŠIFRA VOKEL    | BOJA | ŠIFRA ARTIKLA | PAKIRANJE |
|----------------|------|---------------|-----------|
| <b>1131029</b> | KROM | 12452         | 1         |

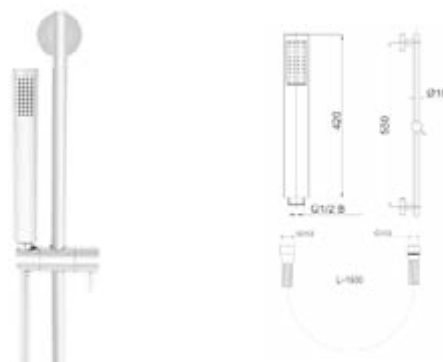

### POMIČNA KONZOLA

| ŠIFRA VOKEL    | BOJA | ŠIFRA ARTIKLA | PAKIRANJE |
|----------------|------|---------------|-----------|
| <b>1131033</b> | KROM | 12655         | 1         |

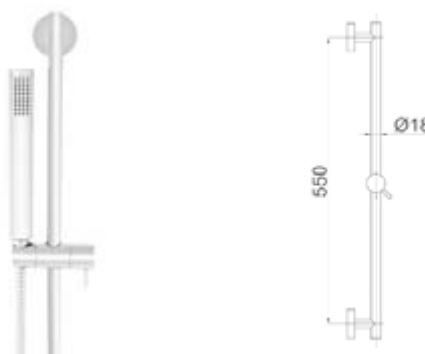

### ZIDNI IZLJEV ZA KADU

| ŠIFRA VOKEL    | BOJA | ŠIFRA ARTIKLA | PAKIRANJE |
|----------------|------|---------------|-----------|
| <b>1131031</b> | KROM | 12202         | 1         |

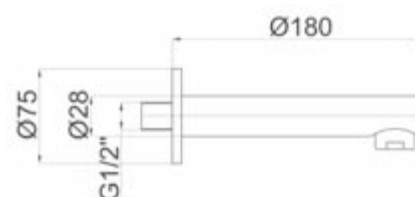

### ZIDNI TUŠ

| ŠIFRA VOKEL    | BOJA | ŠIFRA ARTIKLA | PAKIRANJE |
|----------------|------|---------------|-----------|
| <b>1131025</b> | KROM | 12101         | 1         |

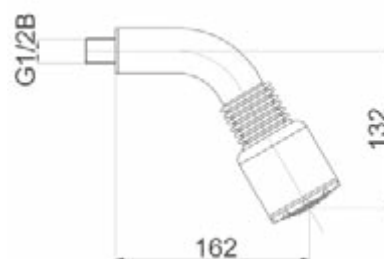

### MLAZNICA TUŠ

| ŠIFRA VOKEL    | BOJA | ŠIFRA ARTIKLA | PAKIRANJE |
|----------------|------|---------------|-----------|
| <b>1131026</b> | KROM | 12102         | 1         |





ZIDNI PRIKLJUČAK ZA TUŠ

| ŠIFRA VOKEL    | BOJA | ŠIFRA ARTIKLA | PAKIRANJE |
|----------------|------|---------------|-----------|
| <b>1131019</b> | KROM | 12204         | 1         |

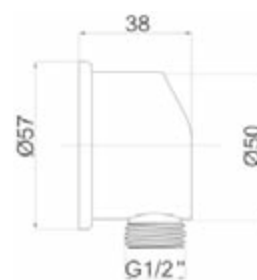

ZIDNI DRŽAČ TUŠA

| ŠIFRA VOKEL    | BOJA | ŠIFRA ARTIKLA | PAKIRANJE |
|----------------|------|---------------|-----------|
| <b>1131020</b> | KROM | 12207         | 1         |

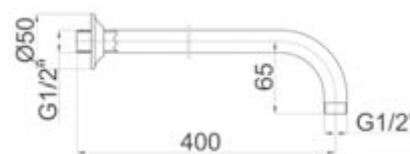

NADGLAVNI TUŠ Ø 200 ABS  
FRESH WATERFALL

| ŠIFRA VOKEL    | BOJA | ŠIFRA ARTIKLA | PAKIRANJE |
|----------------|------|---------------|-----------|
| <b>1131021</b> | KROM | 12103         | 1         |

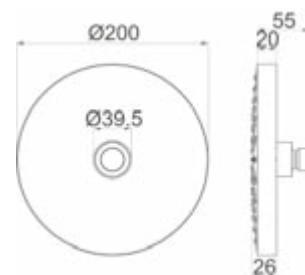

NADGLAVNI TUŠ Ø 200 MESING  
PURE WATERFALL

| ŠIFRA VOKEL    | BOJA | ŠIFRA ARTIKLA | PAKIRANJE |
|----------------|------|---------------|-----------|
| <b>1131022</b> | KROM | 12104         | 1         |

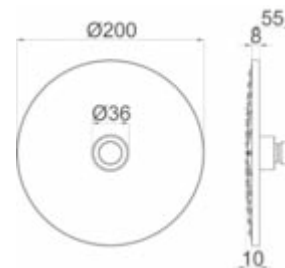

PRODUŽETAK ZA PODŽBUKNU BATERIJU  
Ø 21

| ŠIFRA VOKEL    | BOJA | ŠIFRA ARTIKLA | PAKIRANJE |
|----------------|------|---------------|-----------|
| <b>1131023</b> | KROM | 12701         | 1         |



PRODUŽETAK ZA PODŽBUKNU BATERIJU  
Ø 41,5

| ŠIFRA VOKEL    | BOJA | ŠIFRA ARTIKLA | PAKIRANJE |
|----------------|------|---------------|-----------|
| <b>1131024</b> | KROM | 12703         | 1         |



Simpaty ■ Jednoručne baterije Simpaty







# JEDNORUČNE BATERIJE SIMPATY



BATERIJA ZA UMIVAONIK  
KOMPLET

| ŠIFRA VOKEL  | BOJA | ŠIFRA ARTIKLA | PAKIRANJE |
|--------------|------|---------------|-----------|
| <b>02024</b> | KROM | 00081         | 1         |

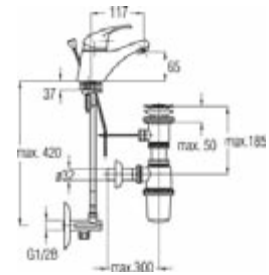

BATERIJA ZA UMIVAONIK  
S KUTNIM VENTILIMA

| ŠIFRA VOKEL  | BOJA | ŠIFRA ARTIKLA | PAKIRANJE |
|--------------|------|---------------|-----------|
| <b>02533</b> | KROM | 00083         | 1         |



BATERIJA ZA UMIVAONIK  
SA 3 CIJEVI

| ŠIFRA VOKEL  | BOJA | ŠIFRA ARTIKLA | PAKIRANJE |
|--------------|------|---------------|-----------|
| <b>02553</b> | KROM | 01081         | 1         |



BATERIJA ZA KUHINJU

| ŠIFRA VOKEL  | BOJA | ŠIFRA ARTIKLA | PAKIRANJE |
|--------------|------|---------------|-----------|
| <b>02023</b> | KROM | 00181         | 1         |

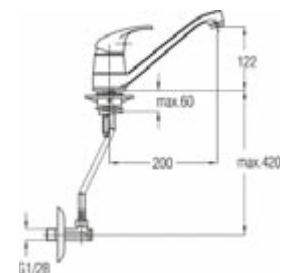

BATERIJA ZA KUHINJU  
SA 3 CIJEVI

| ŠIFRA VOKEL  | BOJA | ŠIFRA ARTIKLA | PAKIRANJE |
|--------------|------|---------------|-----------|
| <b>02022</b> | KROM | 01181         | 1         |

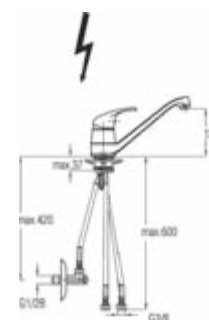

## BATERIJA ZA KUHINJU S KUTNIM VENTILIMA

| ŠIFRA VOKEL    | BOJA | ŠIFRA ARTIKLA | PAKIRANJE |
|----------------|------|---------------|-----------|
| <b>0422020</b> | KROM | 00182         | 1         |

## BATERIJA ZA KUHINJU SA 3 CIJEVI

| ŠIFRA VOKEL    | BOJA | ŠIFRA ARTIKLA | PAKIRANJE |
|----------------|------|---------------|-----------|
| <b>0422021</b> | KROM | 01182         | 1         |

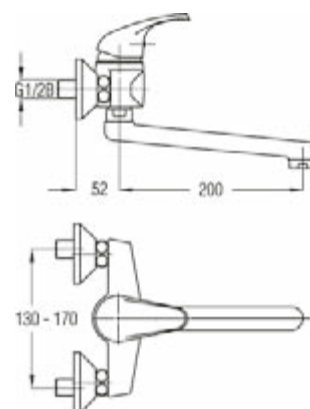

## BATERIJA ZA KUHINJU IZLJEV 200mm

| ŠIFRA VOKEL  | BOJA | ŠIFRA ARTIKLA | PAKIRANJE |
|--------------|------|---------------|-----------|
| <b>02550</b> | KROM | 00281         | 1         |

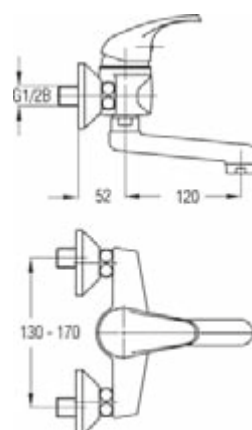

## BATERIJA ZA KUHINJU IZLJEV 120mm

| ŠIFRA VOKEL  | BOJA | ŠIFRA ARTIKLA | PAKIRANJE |
|--------------|------|---------------|-----------|
| <b>02549</b> | KROM | 00282         | 1         |

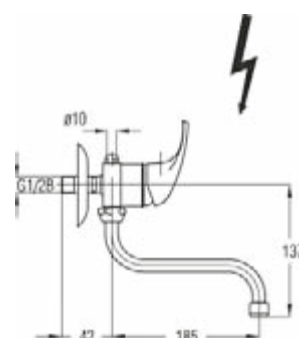

## BATERIJA ZA KUHINJU

| ŠIFRA VOKEL  | BOJA | ŠIFRA ARTIKLA | PAKIRANJE |
|--------------|------|---------------|-----------|
| <b>02542</b> | KROM | 01281         | 1         |

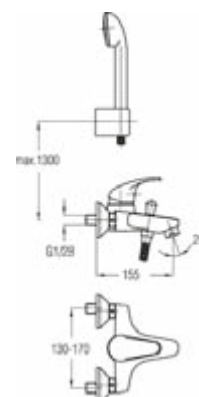

BATERIJA ZA KADU

| ŠIFRA VOKEL  | BOJA | ŠIFRA ARTIKLA | PAKIRANJE |
|--------------|------|---------------|-----------|
| <b>02548</b> | KROM | 00381         | 1         |

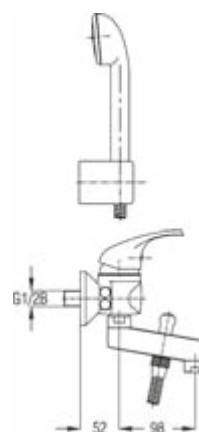

BATERIJA ZA KADU

| ŠIFRA VOKEL  | BOJA | ŠIFRA ARTIKLA | PAKIRANJE |
|--------------|------|---------------|-----------|
| <b>02021</b> | KROM | 00389         | 1         |

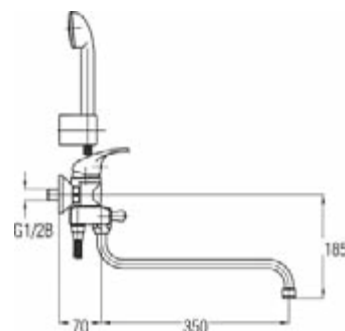

BATERIJA ZA KADU I UMIVAONIK

| ŠIFRA VOKEL  | BOJA | ŠIFRA ARTIKLA | PAKIRANJE |
|--------------|------|---------------|-----------|
| <b>02569</b> | KROM | 00383         | 1         |

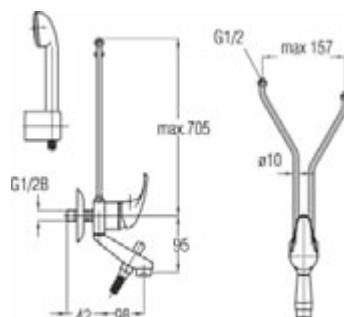

BATERIJA ZA KADU

| ŠIFRA VOKEL  | BOJA | ŠIFRA ARTIKLA | PAKIRANJE |
|--------------|------|---------------|-----------|
| <b>02570</b> | KROM | 01381         | 1         |



## JEDNORUČNE BATERIJE SIMPATY



BATERIJA ZA TUŠ  
SA TUŠ RUČICOM

| ŠIFRA VOKEL  | BOJA | ŠIFRA ARTIKLA | PAKIRANJE |
|--------------|------|---------------|-----------|
| <b>02535</b> | KROM | 00481         | 1         |

BATERIJA ZA TUŠ  
BEZ TUŠ RUČICE

| ŠIFRA VOKEL    | BOJA | ŠIFRA ARTIKLA | PAKIRANJE |
|----------------|------|---------------|-----------|
| <b>0422022</b> | KROM | 00480         | 1         |

0422022

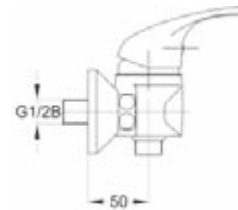

02535

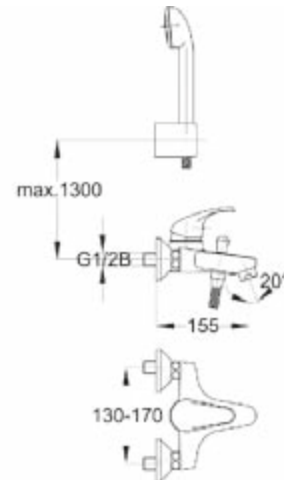

BATERIJA ZA BIDE  
KOMPLET

| ŠIFRA VOKEL  | BOJA | ŠIFRA ARTIKLA | PAKIRANJE |
|--------------|------|---------------|-----------|
| <b>02528</b> | KROM | 00581         | 1         |

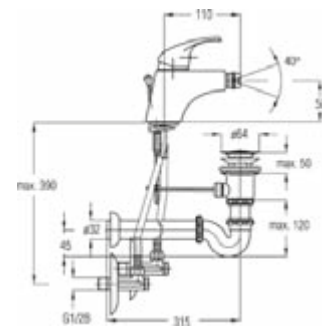

BATERIJA ZA BIDE

| ŠIFRA VOKEL  | BOJA | ŠIFRA ARTIKLA | PAKIRANJE |
|--------------|------|---------------|-----------|
| <b>02554</b> | KROM | 00583         | 1         |

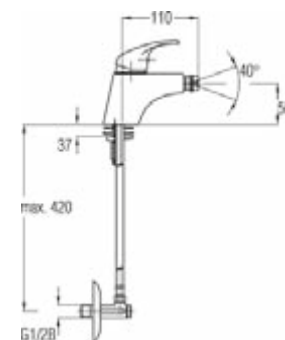







BATERIJA ZA UMIVAONIK  
SA SIFONOM I KUTNIM VENTILIMA

| ŠIFRA VOKEL    | BOJA | ŠIFRA ARTIKLA | PAKIRANJE |
|----------------|------|---------------|-----------|
| <b>1133002</b> | KROM | 00091         | 1         |

SA GORNJIM DIJELOM SIFONA

| ŠIFRA VOKEL    | BOJA | ŠIFRA ARTIKLA | PAKIRANJE |
|----------------|------|---------------|-----------|
| <b>1133001</b> | KROM | 00092         | 1         |

SA IZLJEVOM

| ŠIFRA VOKEL    | BOJA | ŠIFRA ARTIKLA | PAKIRANJE |
|----------------|------|---------------|-----------|
| <b>1133003</b> | KROM | 00093         | 1         |

SA KUTNIM VENTILIMA

| ŠIFRA VOKEL    | BOJA | ŠIFRA ARTIKLA | PAKIRANJE |
|----------------|------|---------------|-----------|
| <b>1133004</b> | KROM | 00094         | 1         |

SA 3 CIJEVI I KUTNIM VENILOM

| ŠIFRA VOKEL    | BOJA | ŠIFRA ARTIKLA | PAKIRANJE |
|----------------|------|---------------|-----------|
| <b>1133005</b> | KROM | 01095         | 1         |

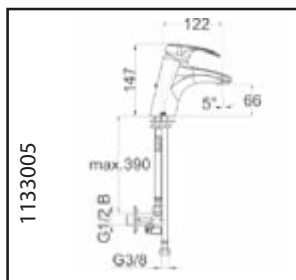
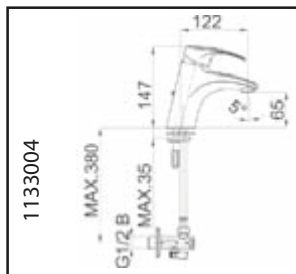
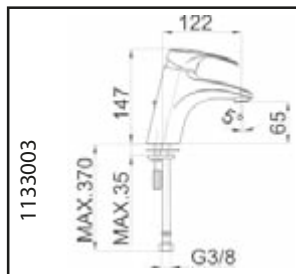
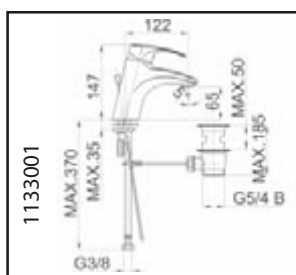
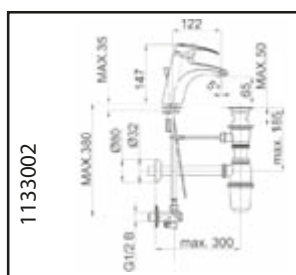

BATERIJA ZA BIDE  
SA SIFONOM I KUTNIM VENTILIMA, IZLJEV 110

| ŠIFRA VOKEL    | BOJA | ŠIFRA ARTIKLA | PAKIRANJE |
|----------------|------|---------------|-----------|
| <b>1133006</b> | KROM | 00591         | 1         |

SA GORNJIM DIJELOM SIFONA

| ŠIFRA VOKEL    | BOJA | ŠIFRA ARTIKLA | PAKIRANJE |
|----------------|------|---------------|-----------|
| <b>1133007</b> | KROM | 00592         | 1         |

SA KUTNIM VENTILIMA

| ŠIFRA VOKEL    | BOJA | ŠIFRA ARTIKLA | PAKIRANJE |
|----------------|------|---------------|-----------|
| <b>1133008</b> | KROM | 00593         | 1         |

BATERIJA ZA BIDE, IZLJEV 110

| ŠIFRA VOKEL    | BOJA | ŠIFRA ARTIKLA | PAKIRANJE |
|----------------|------|---------------|-----------|
| <b>1133009</b> | KROM | 00594         | 1         |

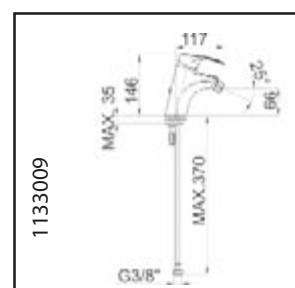
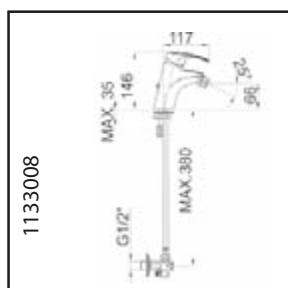
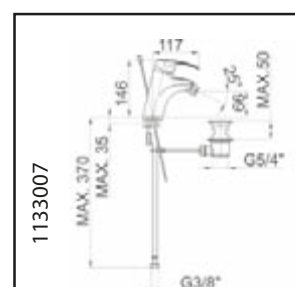
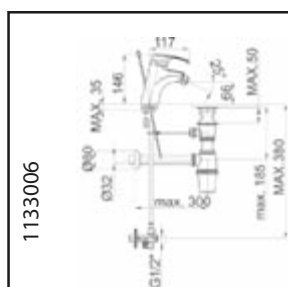



BATERIJA ZA KADU  
ZIDNI DRŽAČ, TUŠ CRIJEVO I RUČICA

| ŠIFRA VOKEL    | BOJA | ŠIFRA ARTIKLA | PAKIRANJE |
|----------------|------|---------------|-----------|
| <b>1133010</b> | KROM | 00393         | 1         |

1133010

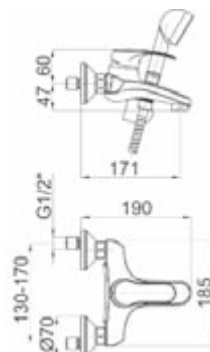

1133011

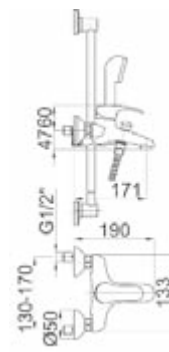

SA IZLJEVOM I POMIČNOM KONZOLOM

| ŠIFRA VOKEL    | BOJA | ŠIFRA ARTIKLA | PAKIRANJE |
|----------------|------|---------------|-----------|
| <b>1133011</b> | KROM | 00394         | 1         |



BATERIJA ZA TUŠ  
ZIDNI DRŽAČ, TUŠ CRIJEVO I RUČICA

| ŠIFRA VOKEL    | BOJA | ŠIFRA ARTIKLA | PAKIRANJE |
|----------------|------|---------------|-----------|
| <b>1133012</b> | KROM | 00491         | 1         |

1133012

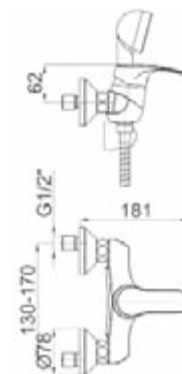

1133013

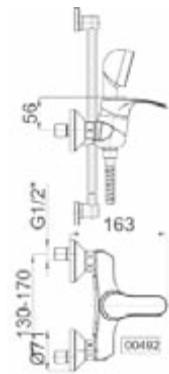

SA POMIČNOM KONZOLOM

| ŠIFRA VOKEL    | BOJA | ŠIFRA ARTIKLA | PAKIRANJE |
|----------------|------|---------------|-----------|
| <b>1133013</b> | KROM | 00492         | 1         |



BATERIJA ZA KUHINJU  
ZIDNI IZLJEV 200 mm

| ŠIFRA VOKEL    | BOJA | ŠIFRA ARTIKLA | PAKIRANJE |
|----------------|------|---------------|-----------|
| <b>1133017</b> | KROM | 00291         | 1         |

1133017

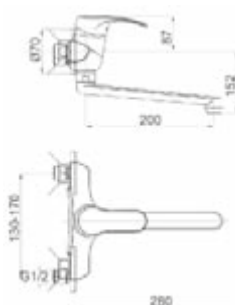

1133018

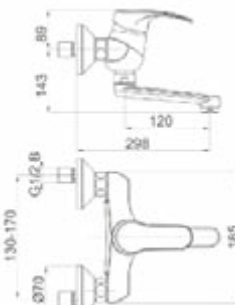

ZIDNI IZLJEV 120 mm

| ŠIFRA VOKEL    | BOJA | ŠIFRA ARTIKLA | PAKIRANJE |
|----------------|------|---------------|-----------|
| <b>1133018</b> | KROM | 00292         | 1         |







BATERIJA ZA UMIVAONIK  
SA KUTNIM VENTILIMA

| ŠIFRA VOKEL    | BOJA | ŠIFRA ARTIKLA | PAKIRANJE |
|----------------|------|---------------|-----------|
| <b>1134014</b> | KROM | 00025         | 1         |

SA GORNJIM DIJELOM SIFONA

| ŠIFRA VOKEL    | BOJA | ŠIFRA ARTIKLA | PAKIRANJE |
|----------------|------|---------------|-----------|
| <b>1134016</b> | KROM | 00024         | 1         |

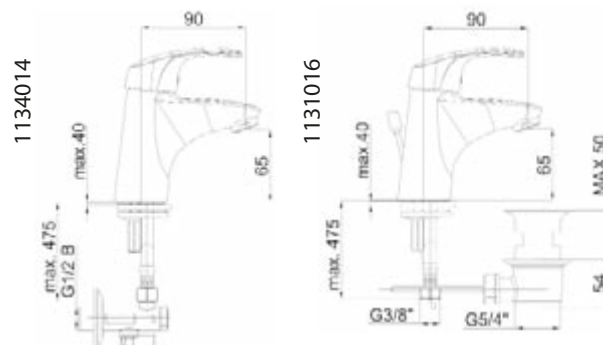

BATERIJA ZA BIDE  
SA GORNJIM DIJELOM SIFONA

| ŠIFRA VOKEL    | BOJA | ŠIFRA ARTIKLA | PAKIRANJE |
|----------------|------|---------------|-----------|
| <b>1134015</b> | KROM | 00516         | 1         |

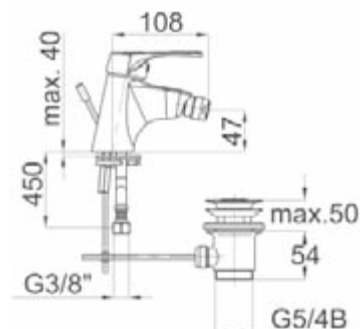

BATERIJA ZA KUHINJU  
SA KUTNIM VENTILIMA

| ŠIFRA VOKEL    | BOJA | ŠIFRA ARTIKLA | PAKIRANJE |
|----------------|------|---------------|-----------|
| <b>1134005</b> | KROM | 00184         | 1         |

BATERIJA ZA KUHINJU

| ŠIFRA VOKEL    | BOJA | ŠIFRA ARTIKLA | PAKIRANJE |
|----------------|------|---------------|-----------|
| <b>1134006</b> | KROM | 00185         | 1         |

SA 3 CIJEVI I KUTNIM VENILOM

| ŠIFRA VOKEL    | BOJA | ŠIFRA ARTIKLA | PAKIRANJE |
|----------------|------|---------------|-----------|
| <b>1134013</b> | KROM | 01185         | 1         |

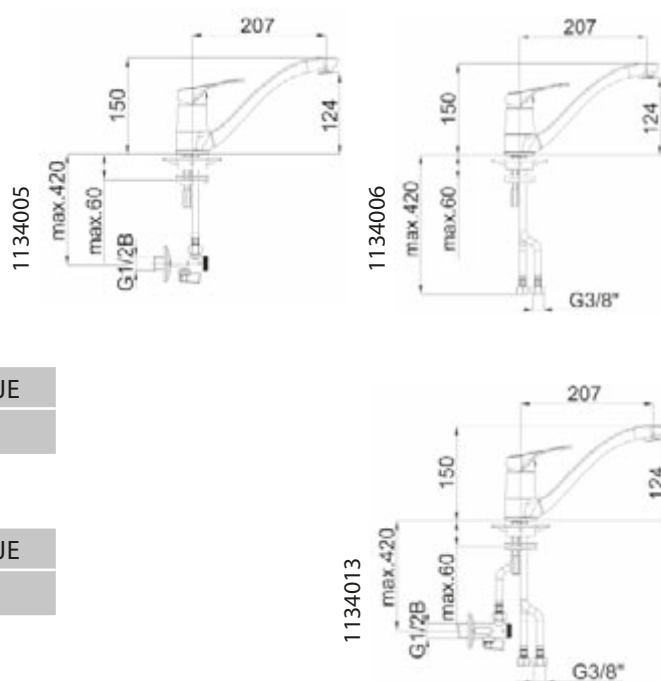





BATERIJA ZA KADU  
SA ZIDNIM NOSAČEM, TUŠ RUČICOM I TUŠ CRIJEVOM

| ŠIFRA VOKEL    | BOJA | ŠIFRA ARTIKLA | PAKIRANJE |
|----------------|------|---------------|-----------|
| <b>1134007</b> | KROM | 00325         | 1         |

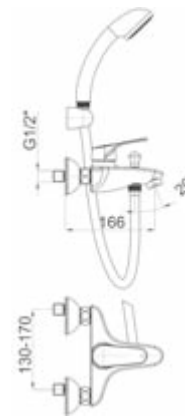

BATERIJA ZA TUŠ  
SA ZIDNIM NOSAČEM, TUŠ RUČICOM I TUŠ CRIJEVOM

| ŠIFRA VOKEL    | BOJA | ŠIFRA ARTIKLA | PAKIRANJE |
|----------------|------|---------------|-----------|
| <b>1134008</b> | KROM | 00425         | 1         |

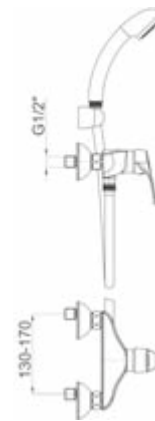

UGRADNA MJEŠALICA  
ZA TUŠ BATERIJU

| ŠIFRA VOKEL    | BOJA | ŠIFRA ARTIKLA | PAKIRANJE |
|----------------|------|---------------|-----------|
| <b>1134017</b> | -    | 00367         | 1         |

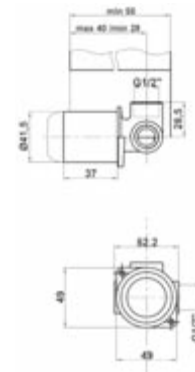

UGRADNA MJEŠALICA  
ZA KADU ILI 2 TUŠ BATERIJE

| ŠIFRA VOKEL    | BOJA | ŠIFRA ARTIKLA | PAKIRANJE |
|----------------|------|---------------|-----------|
| <b>1134018</b> | -    | 00368         | 1         |

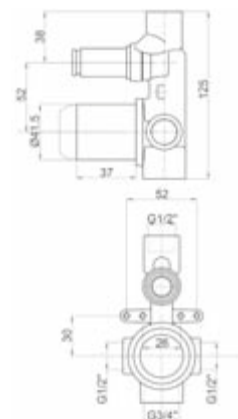



PODŽBUKNA BATERIJA  
ZA TUŠ



| ŠIFRA VOKEL    | BOJA | ŠIFRA ARTIKLA | PAKIRANJE |
|----------------|------|---------------|-----------|
| <b>1134019</b> | KROM | 12251         | 1         |



PODŽBUKNA BATERIJA  
ZA KADU ILI 2 TUŠ BATERIJE



| ŠIFRA VOKEL    | BOJA | ŠIFRA ARTIKLA | PAKIRANJE |
|----------------|------|---------------|-----------|
| <b>1134020</b> | KROM | 12252         | 1         |



ZIDNI IZLJEV ZA KADU

| ŠIFRA VOKEL    | BOJA | ŠIFRA ARTIKLA | PAKIRANJE |
|----------------|------|---------------|-----------|
| <b>1134023</b> | KROM | 12201         | 1         |

SET S KONZOLOM

| ŠIFRA VOKEL    | BOJA | ŠIFRA ARTIKLA | PAKIRANJE |
|----------------|------|---------------|-----------|
| <b>1134021</b> | KROM | 12451         | 1         |

SET S DRŽAČEM

| ŠIFRA VOKEL    | BOJA | ŠIFRA ARTIKLA | PAKIRANJE |
|----------------|------|---------------|-----------|
| <b>1134022</b> | KROM | 12354         | 1         |





BATERIJA ZA UMIVAONIK

| ŠIFRA VOKEL    | BOJA | ŠIFRA ARTIKLA | PAKIRANJE |
|----------------|------|---------------|-----------|
| <b>1158001</b> | KROM | 00002         | 1         |
| <b>1158008</b> | KROM | 00003         | 1         |

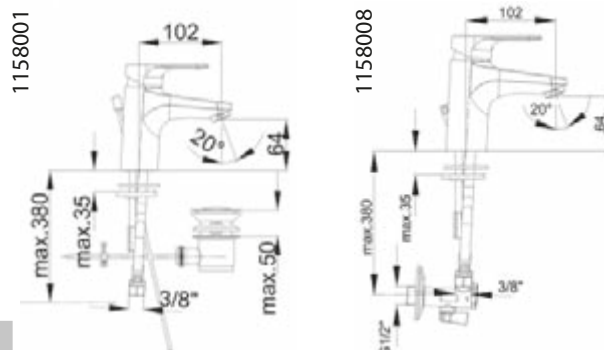

BATERIJA ZA UMIVAONIK-VISOKA  
S GORNJIM DIJELOM SIFONA

| ŠIFRA VOKEL    | BOJA | ŠIFRA ARTIKLA | PAKIRANJE |
|----------------|------|---------------|-----------|
| <b>1158009</b> | KROM | 00012         | 1         |

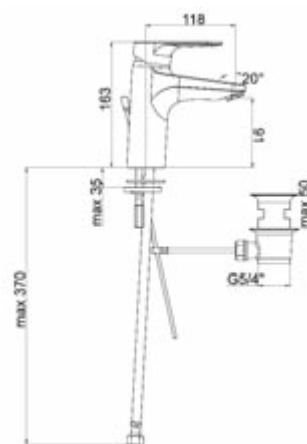

BATERIJA ZA BIDE

| ŠIFRA VOKEL    | BOJA | ŠIFRA ARTIKLA | PAKIRANJE |
|----------------|------|---------------|-----------|
| <b>1158004</b> | KROM | 00503         | 1         |

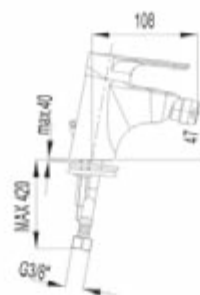

BATERIJA ZA TUŠ

| ŠIFRA VOKEL    | BOJA | ŠIFRA ARTIKLA | PAKIRANJE |
|----------------|------|---------------|-----------|
| <b>1158007</b> | KROM | 00403         | 1         |
| <b>1158002</b> | KROM | 00401         | 1         |

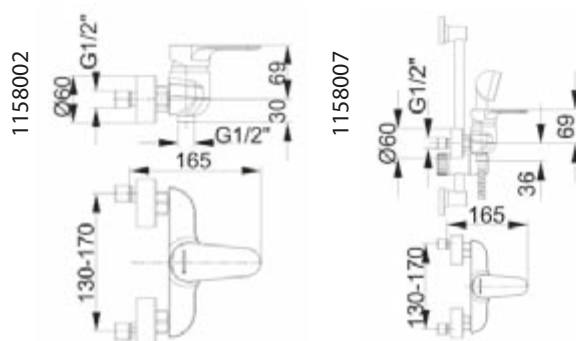



## JEDNORUČNE BATERIJE INFINITY

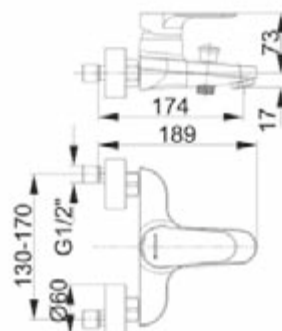

BATERIJA ZA KADU

| ŠIFRA VOKEL    | BOJA | ŠIFRA ARTIKLA | PAKIRANJE |
|----------------|------|---------------|-----------|
| <b>1158003</b> | KROM | 00301         | 1         |

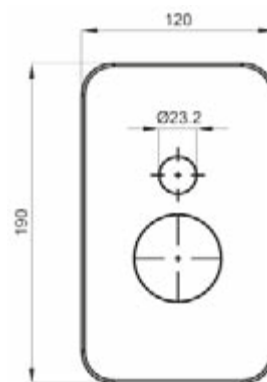

PODŽBUKNA BATERIJA ZA KADU

| ŠIFRA VOKEL    | BOJA | ŠIFRA ARTIKLA | PAKIRANJE |
|----------------|------|---------------|-----------|
| <b>1158006</b> | KROM | 12250         | 1         |

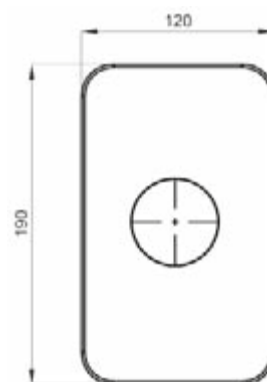

PODŽBUKNA BATERIJA ZA TUŠ

| ŠIFRA VOKEL    | BOJA | ŠIFRA ARTIKLA | PAKIRANJE |
|----------------|------|---------------|-----------|
| <b>1158005</b> | KROM | 12249         | 1         |



ZIDNA SLAVINA-AERATOR

| ŠIFRA VOKEL  | BOJA | ŠIFRA ARTIKLA | PAKIRANJE |
|--------------|------|---------------|-----------|
| <b>04214</b> | KROM | 10052         | 1         |

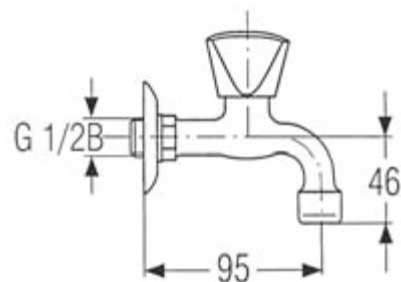

ZIDNA SLAVINA-PRIKLJUČAK

| ŠIFRA VOKEL  | BOJA | ŠIFRA ARTIKLA | PAKIRANJE |
|--------------|------|---------------|-----------|
| <b>04215</b> | KROM | 10151         | 1         |

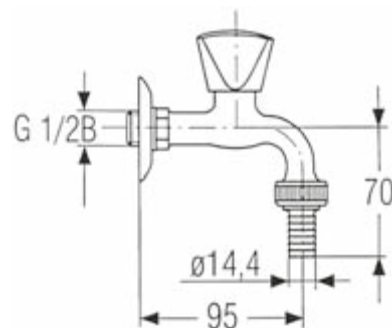

ZIDNA SLAVINA-PRIKLJUČAK

| ŠIFRA VOKEL  | BOJA | ŠIFRA ARTIKLA | PAKIRANJE |
|--------------|------|---------------|-----------|
| <b>04216</b> | KROM | 10152         | 1         |

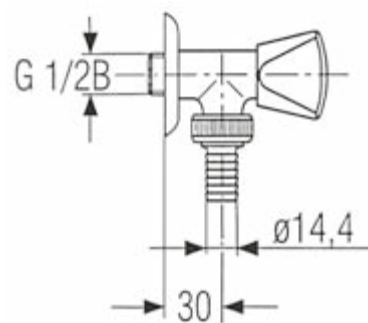

ZIDNA SLAVINA-"S" PRIKLJUČAK

| ŠIFRA VOKEL  | BOJA | ŠIFRA ARTIKLA | PAKIRANJE |
|--------------|------|---------------|-----------|
| <b>04004</b> | KROM | 10251         | 1         |

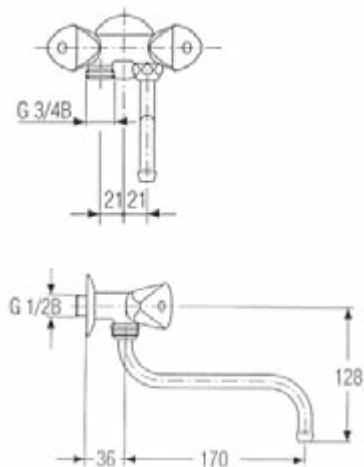





ZIDNA SLAVINA-"S" PRIKLJUČAK Ø13

| ŠIFRA VOKEL  | BOJA | ŠIFRA ARTIKLA | PAKIRANJE |
|--------------|------|---------------|-----------|
| <b>04007</b> | KROM | 10351         | 1         |

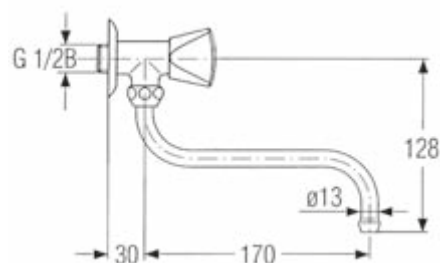

ZIDNA SLAVINA-"S" PRIKLJUČAK Ø18

| ŠIFRA VOKEL  | BOJA | ŠIFRA ARTIKLA | PAKIRANJE |
|--------------|------|---------------|-----------|
| <b>04002</b> | KROM | 10352         | 1         |

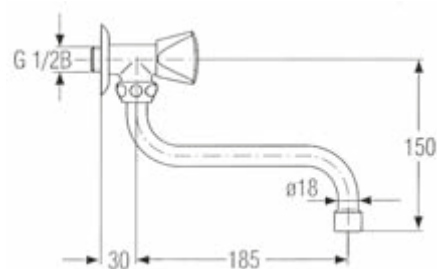

ZIDNA SLAVINA-"HU" PRIKLJUČAK Ø18

| ŠIFRA VOKEL  | BOJA | ŠIFRA ARTIKLA | PAKIRANJE |
|--------------|------|---------------|-----------|
| <b>04339</b> | KROM | 10354         | 1         |

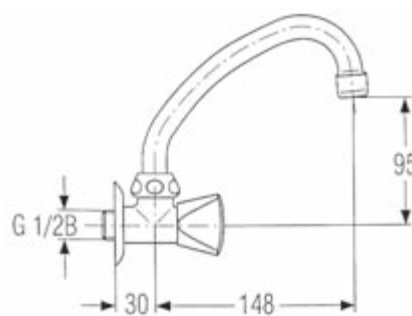

ZIDNA SLAVINA-"U" PRIKLJUČAK Ø13

| ŠIFRA VOKEL  | BOJA | ŠIFRA ARTIKLA | PAKIRANJE |
|--------------|------|---------------|-----------|
| <b>02116</b> | KROM | 10355         | 1         |

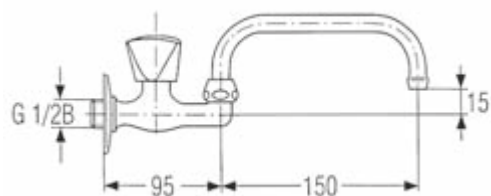



USADNA SLAVINA

| ŠIFRA VOKEL  | BOJA | ŠIFRA ARTIKLA | PAKIRANJE |
|--------------|------|---------------|-----------|
| <b>04132</b> | KROM | 10551         | 1         |

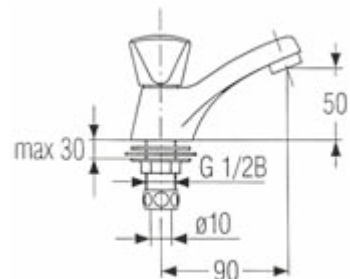

USADNA SLAVINA-"HU" PRIKLJUČAK

| ŠIFRA VOKEL  | BOJA | ŠIFRA ARTIKLA | PAKIRANJE |
|--------------|------|---------------|-----------|
| <b>04131</b> | KROM | 10651         | 1         |

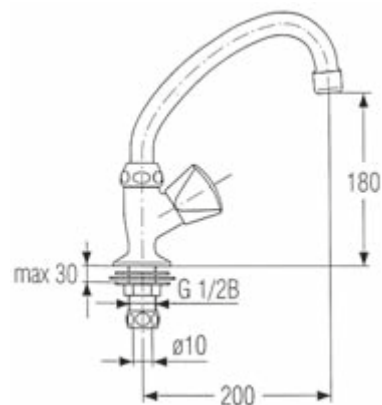

■ Ugradne baterije



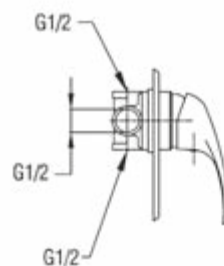
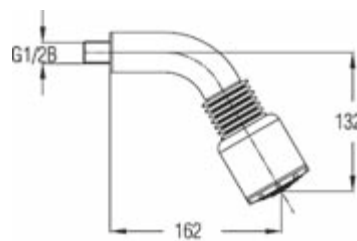

UGRADNA BATERIJA ZA TUŠ

| ŠIFRA VOKEL | BOJA | ŠIFRA ARTIKLA | PAKIRANJE |
|-------------|------|---------------|-----------|
| 02469       | KROM | 00475         | 1         |

■ Senzorske baterije







SENZORSKA BATERIJA ZA UMIVAONIK

| ŠIFRA VOKEL  | BOJA | ŠIFRA ARTIKLA | PAKIRANJE |
|--------------|------|---------------|-----------|
| <b>02451</b> | KROM | 09011         | 1         |

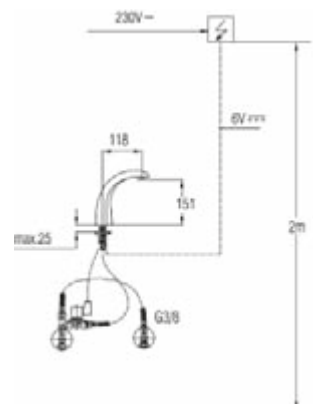

NADŽBUKNI SENZORSKI ISPIRAČ ZA PISOAR – BATERIJSKI

| ŠIFRA VOKEL  | BOJA | ŠIFRA ARTIKLA | PAKIRANJE |
|--------------|------|---------------|-----------|
| <b>02571</b> | KROM | 09501         | 1         |

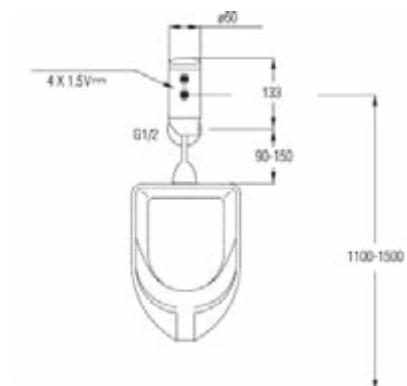

PODŽBUKNI SENZORSKI ISPIRAČ ZA PISOAR

| ŠIFRA VOKEL    | BOJA | ŠIFRA ARTIKLA | PAKIRANJE |
|----------------|------|---------------|-----------|
| <b>02449</b>   | KROM | 09502         | 1         |
| <b>0503006</b> | KROM | 09508         | 1         |

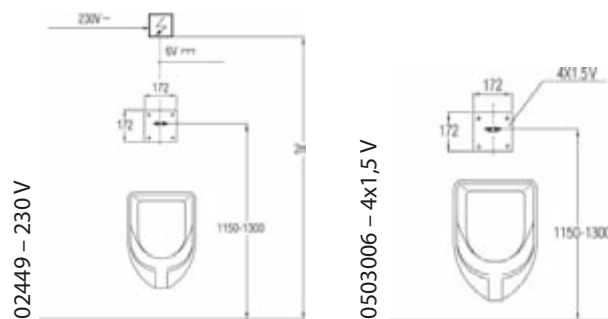

PRIKLJUČNA ARMATURA ZA PISOAR

| ŠIFRA VOKEL  | BOJA | ŠIFRA ARTIKLA | PAKIRANJE |
|--------------|------|---------------|-----------|
| <b>02572</b> | KROM | 19029         | 1         |

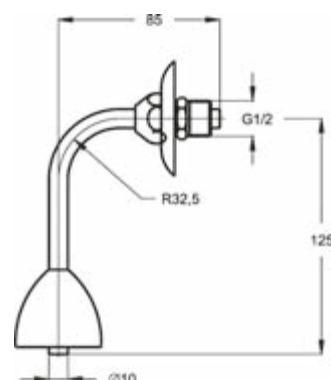



SENZORSKA BATERIJA ZA TUŠ – 230 V

| ŠIFRA VOKEL    | BOJA | ŠIFRA ARTIKLA | PAKIRANJE |
|----------------|------|---------------|-----------|
| <b>0503005</b> | KROM | 09401         | 1         |

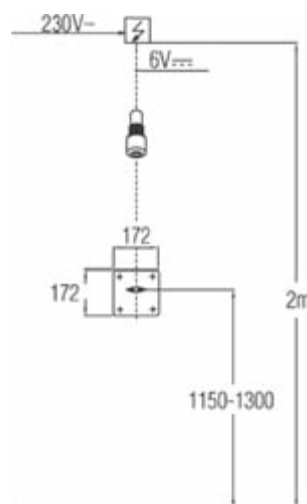

POKROVNÁ PLOČA SA SENZOROM

| ŠIFRA VOKEL    | BOJA     | ŠIFRA ARTIKLA | PAKIRANJE |
|----------------|----------|---------------|-----------|
| <b>0503007</b> | KROM-MAT | 12263         | 1         |

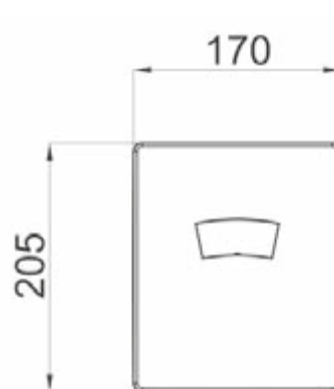

PODŽBUKNI SENZORSKI ISPIRAČ ZA PISOAR-9V

| ŠIFRA VOKEL    | BOJA | ŠIFRA ARTIKLA | PAKIRANJE |
|----------------|------|---------------|-----------|
| <b>0503008</b> | KROM | 09510         | 1         |

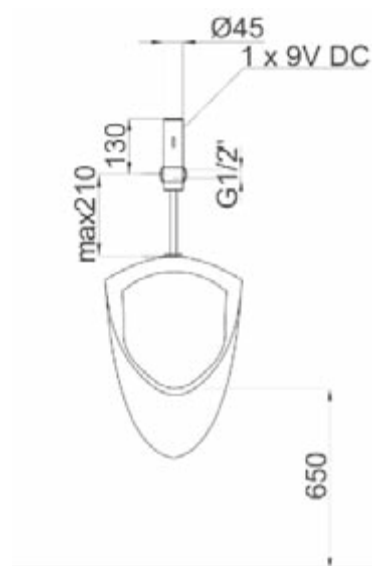





BATERIJA ZA UMIVAONIK  
LIJEVANI IZLJEV

| ŠIFRA VOKEL  | BOJA       | ŠIFRA ARTIKLA | PAKIRANJE |
|--------------|------------|---------------|-----------|
| <b>02147</b> | KROM/ZLATO | 07061         | 1         |
| <b>02442</b> | KROM       | 07063         | 1         |

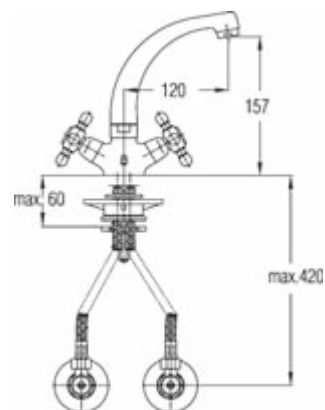

BATERIJA ZA UMIVAONIK  
"J" IZLJEV

| ŠIFRA VOKEL  | BOJA       | ŠIFRA ARTIKLA | PAKIRANJE |
|--------------|------------|---------------|-----------|
| <b>02211</b> | KROM/ZLATO | 07062         | 1         |
| <b>02443</b> | KROM       | 07064         | 1         |

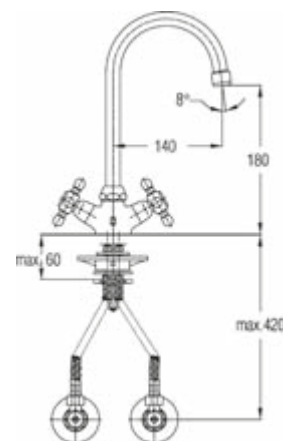

BATERIJA ZA UMIVAONIK S GORNJIM DIJELOM SIFONA

| ŠIFRA VOKEL    | BOJA       | ŠIFRA ARTIKLA | PAKIRANJE |
|----------------|------------|---------------|-----------|
| <b>0424027</b> | KROM/ZLATO | 07072         | 1         |

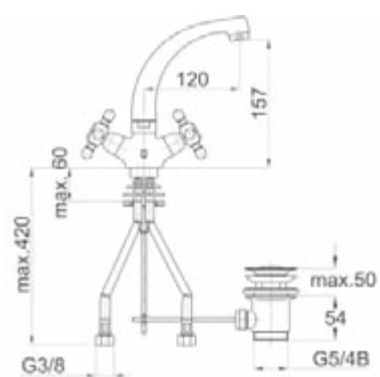

BATERIJA ZA UMIVAONIK

| ŠIFRA VOKEL    | BOJA       | ŠIFRA ARTIKLA | PAKIRANJE |
|----------------|------------|---------------|-----------|
| <b>0424028</b> | KROM/ZLATO | 07066         | 1         |

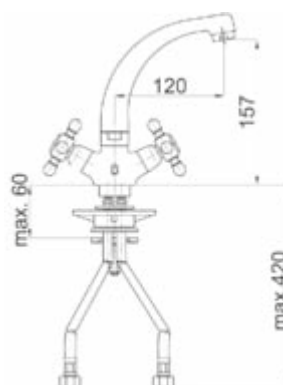



BATERIJA ZA KUHINJU  
"HU" IZLJEV

| ŠIFRA VOKEL  | BOJA       | ŠIFRA ARTIKLA | PAKIRANJE |
|--------------|------------|---------------|-----------|
| <b>02212</b> | KROM/ZLATO | 07156         | 1         |
| <b>02444</b> | KROM       | 07158         | 1         |

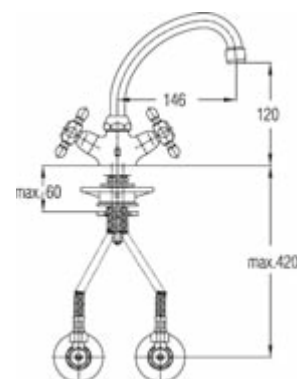

BATERIJA ZA KUHINJU  
"HU" IZLJEV

| ŠIFRA VOKEL  | BOJA       | ŠIFRA ARTIKLA | PAKIRANJE |
|--------------|------------|---------------|-----------|
| <b>02457</b> | KROM/ZLATO | 08157         | 1         |
| <b>02574</b> | KROM       | 08158         | 1         |

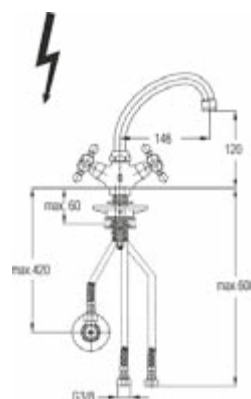

BATERIJA ZA KUHINJU  
"J" IZLJEV

| ŠIFRA VOKEL  | BOJA       | ŠIFRA ARTIKLA | PAKIRANJE |
|--------------|------------|---------------|-----------|
| <b>02213</b> | KROM/ZLATO | 07157         | 1         |
| <b>02573</b> | KROM       | 07159         | 1         |

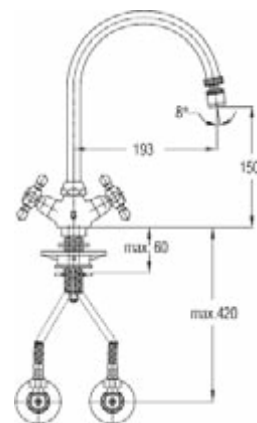

BATERIJA ZA KUHINJU  
"J" IZLJEV

| ŠIFRA VOKEL  | BOJA       | ŠIFRA ARTIKLA | PAKIRANJE |
|--------------|------------|---------------|-----------|
| <b>02575</b> | KROM/ZLATO | 08160         | 1         |
| <b>02576</b> | KROM       | 08161         | 1         |

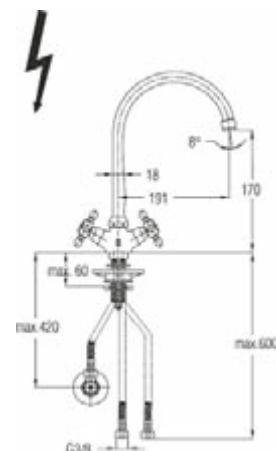





BATERIJA ZA KUHINJU  
"S" IZLJEV

| ŠIFRA VOKEL  | BOJA       | ŠIFRA ARTIKLA | PAKIRANJE |
|--------------|------------|---------------|-----------|
| <b>02148</b> | KROM/ZLATO | 07260         | 1         |
| <b>02445</b> | KROM       | 07263         | 1         |

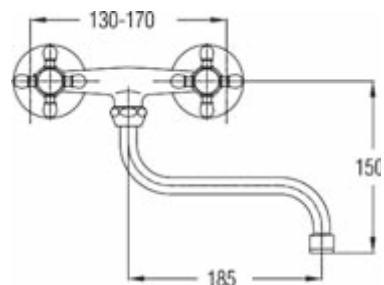

BATERIJA ZA KUHINJU  
"U" IZLJEV

| ŠIFRA VOKEL  | BOJA       | ŠIFRA ARTIKLA | PAKIRANJE |
|--------------|------------|---------------|-----------|
| <b>02214</b> | KROM/ZLATO | 07261         | 1         |

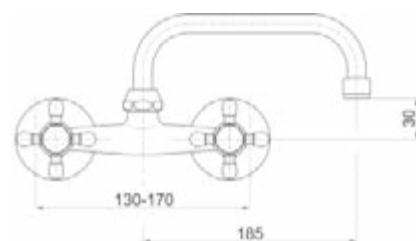

BATERIJA ZA KUHINJU  
"HU" IZLJEV

| ŠIFRA VOKEL  | BOJA       | ŠIFRA ARTIKLA | PAKIRANJE |
|--------------|------------|---------------|-----------|
| <b>02215</b> | KROM/ZLATO | 07262         | 1         |
| <b>02577</b> | KROM       | 07265         | 1         |

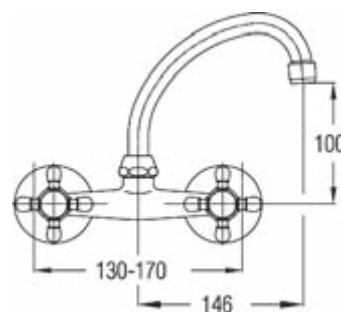

BATERIJA ZA KUHINJU  
"S" IZLJEV

| ŠIFRA VOKEL  | BOJA       | ŠIFRA ARTIKLA | PAKIRANJE |
|--------------|------------|---------------|-----------|
| <b>02458</b> | KROM/ZLATO | 08255         | 1         |
| <b>02461</b> | KROM       | 08256         | 1         |

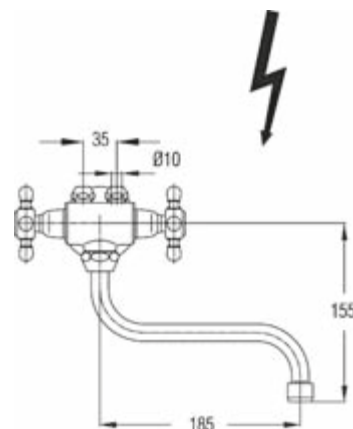



BATERIJA ZA KADU

| ŠIFRA VOKEL  | BOJA       | ŠIFRA ARTIKLA | PAKIRANJE |
|--------------|------------|---------------|-----------|
| <b>02150</b> | KROM/ZLATO | 07357         | 1         |
| <b>02446</b> | KROM       | 07358         | 1         |

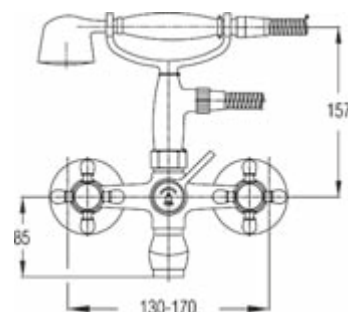

BATERIJA ZA TUŠ  
SA ZIDNIM DRŽAČEM

| ŠIFRA VOKEL  | BOJA       | ŠIFRA ARTIKLA | PAKIRANJE |
|--------------|------------|---------------|-----------|
| <b>02578</b> | KROM/ZLATO | 07462         | 1         |
| <b>02579</b> | KROM       | 07464         | 1         |

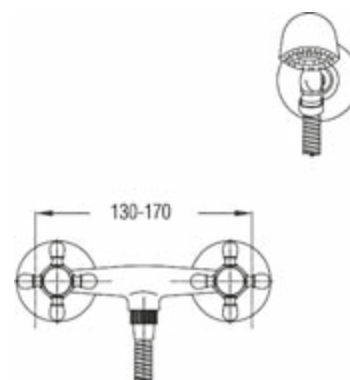

BATERIJA ZA TUŠ  
SA KONZOLOM

| ŠIFRA VOKEL  | BOJA       | ŠIFRA ARTIKLA | PAKIRANJE |
|--------------|------------|---------------|-----------|
| <b>02216</b> | KROM/ZLATO | 07461         | 1         |

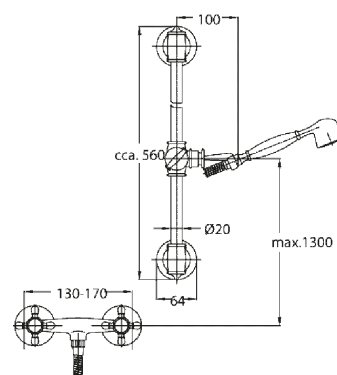

BATERIJA ZA BIDE  
KOMPLET

| ŠIFRA VOKEL  | BOJA       | ŠIFRA ARTIKLA | PAKIRANJE |
|--------------|------------|---------------|-----------|
| <b>02158</b> | KROM/ZLATO | 07554         | 1         |
| <b>02447</b> | KROM       | 07555         | 1         |

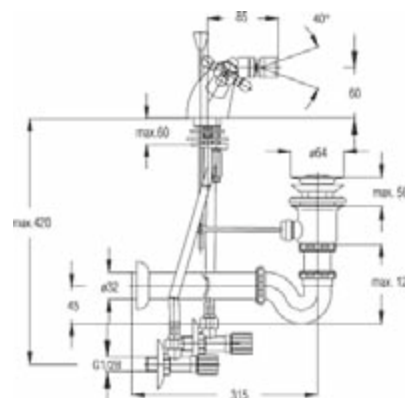

Val ■ Keramik dvoručne baterije Val





## DVORUČNE BATERIJE VAL



BATERIJA ZA UMIVAONIK  
LIJEVANI IZLJEV

| ŠIFRA VOKEL  | BOJA       | ŠIFRA ARTIKLA | PAKIRANJE |
|--------------|------------|---------------|-----------|
| <b>02146</b> | KROM/ZLATO | 07051         | 1         |
| <b>02164</b> | KROM       | 07053         | 1         |

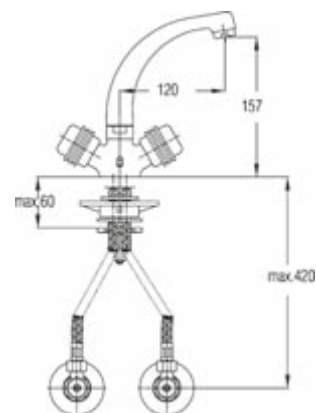

BATERIJA ZA UMIVAONIK  
"J" IZLJEV

| ŠIFRA VOKEL  | BOJA       | ŠIFRA ARTIKLA | PAKIRANJE |
|--------------|------------|---------------|-----------|
| <b>02186</b> | KROM/ZLATO | 07056         | 1         |
| <b>02198</b> | KROM       | 07057         | 1         |

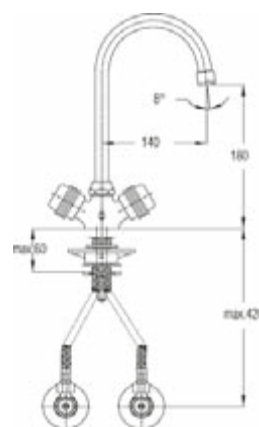

BATERIJA ZA KUHINJU  
"HU" IZLJEV

| ŠIFRA VOKEL  | BOJA       | ŠIFRA ARTIKLA | PAKIRANJE |
|--------------|------------|---------------|-----------|
| <b>02188</b> | KROM/ZLATO | 07151         | 1         |
| <b>02200</b> | KROM       | 07153         | 1         |

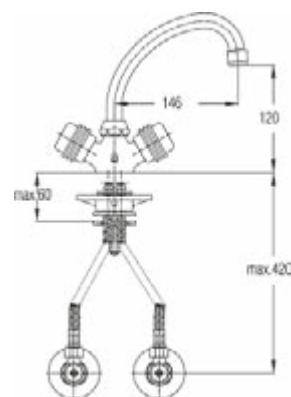

BATERIJA ZA KUHINJU  
"J" IZLJEV

| ŠIFRA VOKEL  | BOJA       | ŠIFRA ARTIKLA | PAKIRANJE |
|--------------|------------|---------------|-----------|
| <b>02189</b> | KROM/ZLATO | 07154         | 1         |
| <b>02201</b> | KROM       | 07155         | 1         |

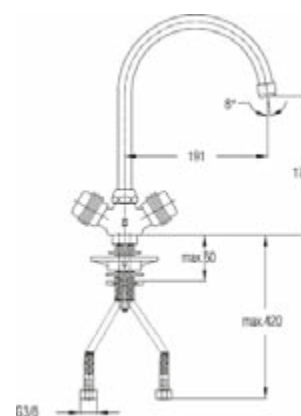



BATERIJA ZA KUHINJU  
"HU" IZLJEV

| ŠIFRA VOKEL  | BOJA       | ŠIFRA ARTIKLA | PAKIRANJE |
|--------------|------------|---------------|-----------|
| <b>02153</b> | KROM/ZLATO | 08151         | 1         |
| <b>02207</b> | KROM       | 08153         | 1         |

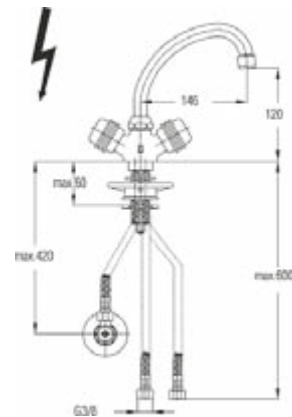

BATERIJA ZA KUHINJU  
"J" IZLJEV

| ŠIFRA VOKEL  | BOJA       | ŠIFRA ARTIKLA | PAKIRANJE |
|--------------|------------|---------------|-----------|
| <b>02195</b> | KROM/ZLATO | 08154         | 1         |
| <b>02208</b> | KROM       | 08155         | 1         |

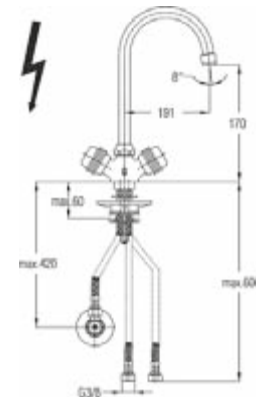

BATERIJA ZA KUHINJU  
"S" IZLJEV

| ŠIFRA VOKEL  | BOJA       | ŠIFRA ARTIKLA | PAKIRANJE |
|--------------|------------|---------------|-----------|
| <b>02190</b> | KROM/ZLATO | 07251         | 1         |
| <b>02202</b> | KROM       | 07257         | 1         |

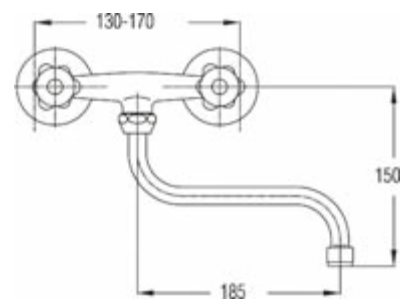

BATERIJA ZA KUHINJU

| ŠIFRA VOKEL  | BOJA       | ŠIFRA ARTIKLA | PAKIRANJE |
|--------------|------------|---------------|-----------|
| <b>02196</b> | KROM/ZLATO | 08252         | 1         |
| <b>02209</b> | KROM       | 08251         | 1         |

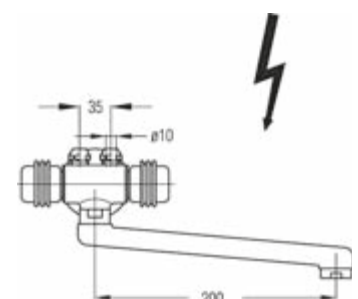





## DVORUČNE BATERIJE VAL



BATERIJA ZA KUHINJU  
"S" IZLJEV

| ŠIFRA VOKEL  | BOJA       | ŠIFRA ARTIKLA | PAKIRANJE |
|--------------|------------|---------------|-----------|
| <b>02154</b> | KROM/ZLATO | 08254         | 1         |
| <b>02210</b> | KROM       | 08253         | 1         |

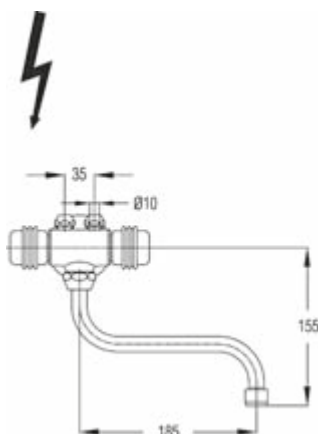

BATERIJA ZA KADU

| ŠIFRA VOKEL  | BOJA       | ŠIFRA ARTIKLA | PAKIRANJE |
|--------------|------------|---------------|-----------|
| <b>02149</b> | KROM/ZLATO | 07351         | 1         |
| <b>02165</b> | KROM       | 07355         | 1         |

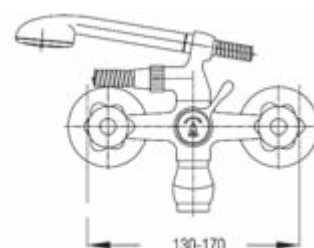

BATERIJA ZA TUŠ

| ŠIFRA VOKEL  | BOJA       | ŠIFRA ARTIKLA | PAKIRANJE |
|--------------|------------|---------------|-----------|
| <b>02194</b> | KROM/ZLATO | 07451         | 1         |
| <b>02206</b> | KROM       | 07452         | 1         |

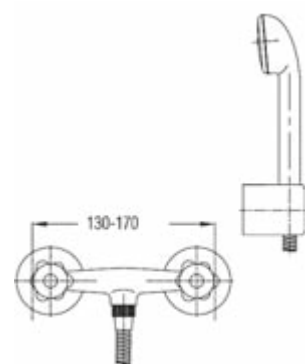

BATERIJA ZA BIDE  
KOMPLET

| ŠIFRA VOKEL  | BOJA       | ŠIFRA ARTIKLA | PAKIRANJE |
|--------------|------------|---------------|-----------|
| <b>02157</b> | KROM/ZLATO | 07551         | 1         |
| <b>02166</b> | KROM       | 07553         | 1         |

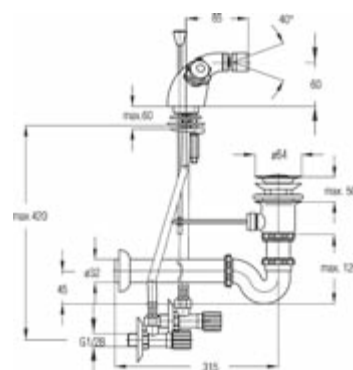

## BATERIJA ZA UMIVAONIK LIJEVANA CIJEV

| ŠIFRA VOKEL  | BOJA       | ŠIFRA ARTIKLA | PAKIRANJE |
|--------------|------------|---------------|-----------|
| <b>02185</b> | KROM/ZLATO | 07054         | 1         |
| <b>02197</b> | KROM       | 07055         | 1         |

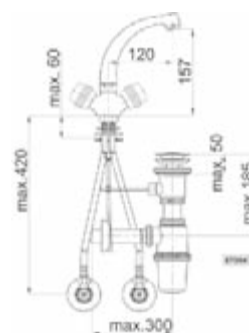

## BATERIJA ZA UMIVAONIK "J" IZLJEV

| ŠIFRA VOKEL  | BOJA       | ŠIFRA ARTIKLA | PAKIRANJE |
|--------------|------------|---------------|-----------|
| <b>02187</b> | KROM/ZLATO | 07058         | 1         |
| <b>02199</b> | KROM       | 07059         | 1         |

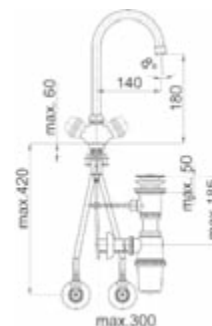

## BATERIJA ZA KUHINJU "U" IZLJEV

| ŠIFRA VOKEL  | BOJA       | ŠIFRA ARTIKLA | PAKIRANJE |
|--------------|------------|---------------|-----------|
| <b>02191</b> | KROM/ZLATO | 07252         | 1         |
| <b>02203</b> | KROM       | 07258         | 1         |

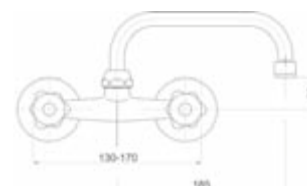

## BATERIJA ZA KUHINJU "HU" IZLJEV

| ŠIFRA VOKEL  | BOJA       | ŠIFRA ARTIKLA | PAKIRANJE |
|--------------|------------|---------------|-----------|
| <b>02192</b> | KROM/ZLATO | 07253         | 1         |
| <b>02204</b> | KROM       | 07259         | 1         |

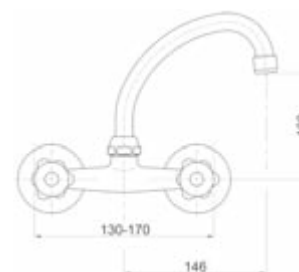

## BATERIJA ZA KADU I UMIVAONIK

| ŠIFRA VOKEL  | BOJA       | ŠIFRA ARTIKLA | PAKIRANJE |
|--------------|------------|---------------|-----------|
| <b>02193</b> | KROM/ZLATO | 07352         | 1         |
| <b>02205</b> | KROM       | 07356         | 1         |

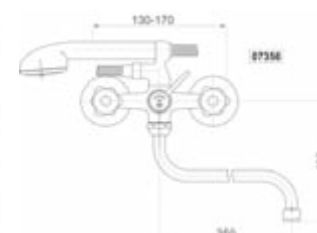



■ Dvoručne baterije Klasik



## BATERIJA ZA UMIVAONIK

| ŠIFRA VOKEL  | BOJA | ŠIFRA ARTIKLA | PAKIRANJE |
|--------------|------|---------------|-----------|
| <b>02110</b> | KROM | 05055         | 1         |

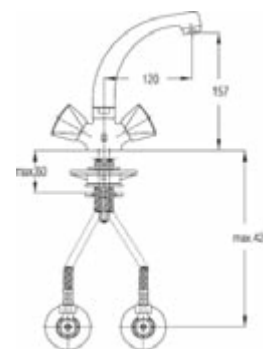

## BATERIJA ZA KUHINJU

| ŠIFRA VOKEL  | BOJA | ŠIFRA ARTIKLA    | PAKIRANJE |
|--------------|------|------------------|-----------|
| <b>02108</b> | KROM | 05153 – 2 CIJEVI | 1         |
| <b>02081</b> | KROM | 06156 – 3 CIJEVI | 1         |

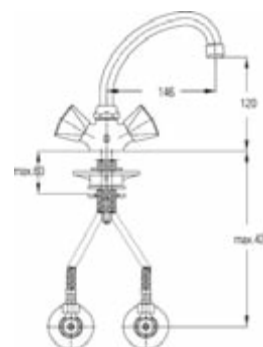

## BATERIJA ZA KUHINJU "S" IZLJEV

| ŠIFRA VOKEL  | BOJA | ŠIFRA ARTIKLA | PAKIRANJE |
|--------------|------|---------------|-----------|
| <b>02040</b> | KROM | 05251         | 1         |

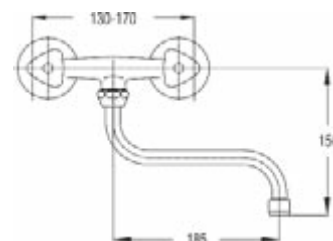

## BATERIJA ZA KUHINJU "U" IZLJEV

| ŠIFRA VOKEL  | BOJA | ŠIFRA ARTIKLA | PAKIRANJE |
|--------------|------|---------------|-----------|
| <b>02044</b> | KROM | 05252         | 1         |

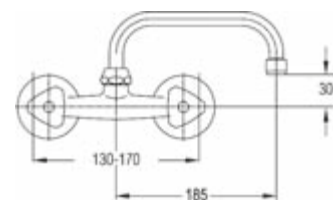

## BATERIJA ZA KUHINJU "HU" IZLJEV

| ŠIFRA VOKEL  | BOJA | ŠIFRA ARTIKLA | PAKIRANJE |
|--------------|------|---------------|-----------|
| <b>02172</b> | KROM | 05253         | 1         |

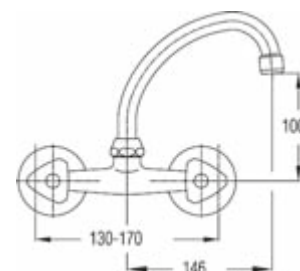





PURE WATERFALL TUŠ SET  
ZA ZIDNI ILI UGRADNI TUŠ

| ŠIFRA VOKEL    | BOJA | ŠIFRA ARTIKLA | PAKIRANJE |
|----------------|------|---------------|-----------|
| <b>0504091</b> | KROM | 12551         | 1         |

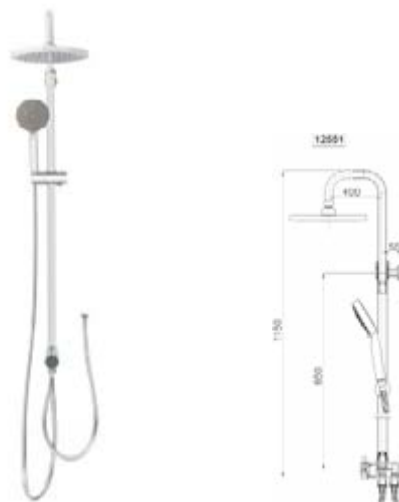

TUŠ SET  
TUŠ KONZOLA +CRIJEVO S RUČICOM+NADGLAVNI  
TUŠ S NOSAČEM TUŠA

| ŠIFRA VOKEL    | BOJA   | ŠIFRA ARTIKLA | PAKIRANJE |
|----------------|--------|---------------|-----------|
| <b>0504098</b> | BIJELO | 12552         | 1         |



SET ZA KONZOLU - FRESH

| ŠIFRA VOKEL    | BOJA | ŠIFRA ARTIKLA | PAKIRANJE |
|----------------|------|---------------|-----------|
| <b>1131029</b> | KROM | 12452         | 1         |

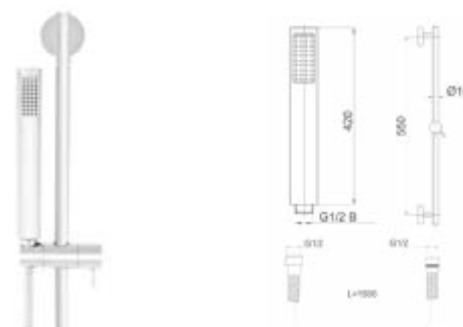

SET ZA KONZOLU - PROJECT

| ŠIFRA VOKEL    | BOJA | ŠIFRA ARTIKLA | PAKIRANJE |
|----------------|------|---------------|-----------|
| <b>1131021</b> | KROM | 12451         | 1         |

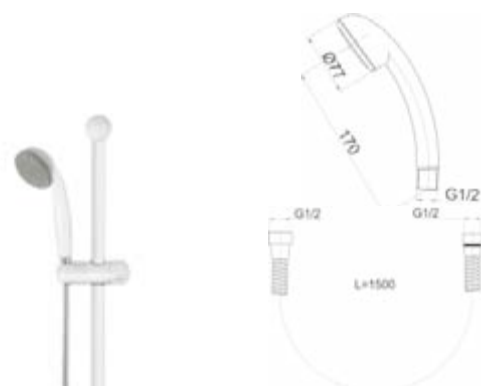

SET S KONZOLOM-INFINITY

| ŠIFRA VOKEL    | BOJA | ŠIFRA ARTIKLA | PAKIRANJE |
|----------------|------|---------------|-----------|
| <b>0504109</b> | KROM | 12460         | 1         |



ZIDNI TUŠ

| ŠIFRA VOKEL    | BOJA | ŠIFRA ARTIKLA | PAKIRANJE |
|----------------|------|---------------|-----------|
| <b>0504111</b> | KROM | 12462         | 1         |

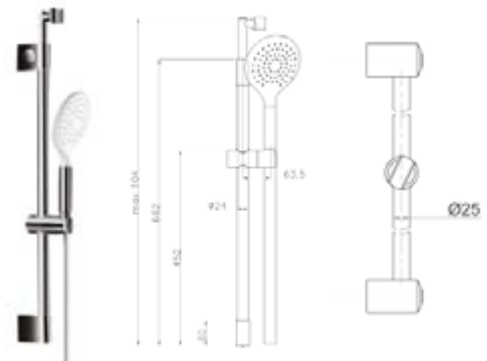

ZIDNI TUŠ

| ŠIFRA VOKEL    | BOJA | ŠIFRA ARTIKLA | PAKIRANJE |
|----------------|------|---------------|-----------|
| <b>0504110</b> | KROM | 12461         | 1         |

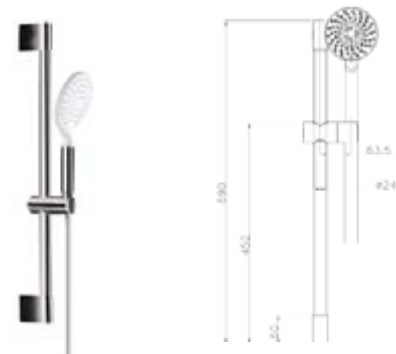

SET S KONZOLOM-PRESTIGE

| ŠIFRA VOKEL    | BOJA | ŠIFRA ARTIKLA | PAKIRANJE |
|----------------|------|---------------|-----------|
| <b>0504106</b> | KROM | 12459         | 1         |

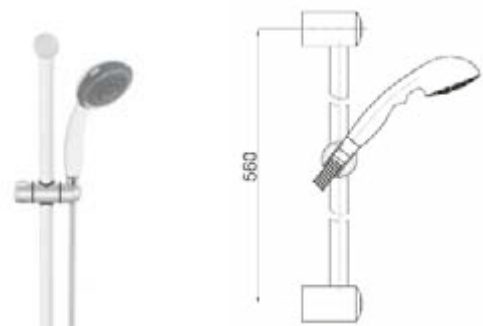

POMIČNA KONZOLA-FRESH

| ŠIFRA VOKEL    | BOJA | ŠIFRA ARTIKLA | PAKIRANJE |
|----------------|------|---------------|-----------|
| <b>0504112</b> | KROM | 12651         | 1         |



### RUČICA ZA TUŠ - PURE 2

| ŠIFRA VOKEL    | BOJA | ŠIFRA ARTIKLA | PAKIRANJE |
|----------------|------|---------------|-----------|
| <b>0504102</b> | KROM | 12050         | 1         |



### TUŠ RUČICA

| ŠIFRA VOKEL    | BOJA | ŠIFRA ARTIKLA | PAKIRANJE |
|----------------|------|---------------|-----------|
| <b>0504113</b> | KROM | 12041         | 1         |



### TUŠ RUČICA-HARMONY

| ŠIFRA VOKEL    | BOJA | ŠIFRA ARTIKLA | PAKIRANJE |
|----------------|------|---------------|-----------|
| <b>0504115</b> | KROM | 12043         | 1         |



### RUČICA ZA TUŠ- THIN

| ŠIFRA VOKEL    | BOJA | ŠIFRA ARTIKLA | PAKIRANJE |
|----------------|------|---------------|-----------|
| <b>0504103</b> | KROM | 12051         | 1         |

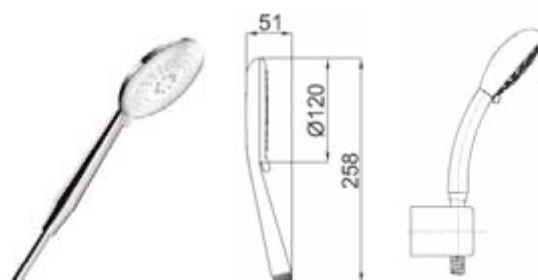

### RUČNI TUŠ -PRESTIGE

| ŠIFRA VOKEL    | BOJA | ŠIFRA ARTIKLA | PAKIRANJE |
|----------------|------|---------------|-----------|
| <b>0504107</b> | KROM | 12044         | 1         |



### SET ZA ZIDNIM DRŽAČEM - SIMPATY

| ŠIFRA VOKEL    | BOJA | ŠIFRA ARTIKLA | PAKIRANJE |
|----------------|------|---------------|-----------|
| <b>0504108</b> | KROM | 12358         | 1         |



### RUČICA ZA TUŠ - SMART

| ŠIFRA VOKEL    | BOJA | ŠIFRA ARTIKLA | PAKIRANJE |
|----------------|------|---------------|-----------|
| <b>0504104</b> | KROM | 12052         | 1         |

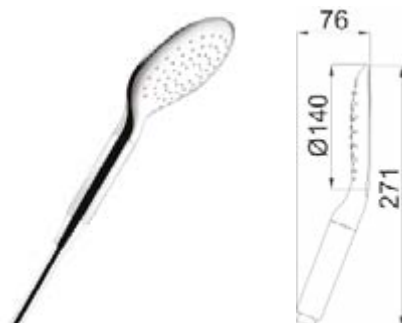

### ZIDNI DRŽAČ - PURE ZA TUŠ

| ŠIFRA VOKEL    | BOJA | ŠIFRA ARTIKLA | PAKIRANJE |
|----------------|------|---------------|-----------|
| <b>0504093</b> | KROM | 12152         | 1         |



### NADGLAVNI TUŠ 26x20 cm

| ŠIFRA VOKEL    | BOJA | ŠIFRA ARTIKLA | PAKIRANJE |
|----------------|------|---------------|-----------|
| <b>0504099</b> | /    | 12106         | 1         |



### IZLJEV ZA TUŠ RUŽU 41,4 cm

| ŠIFRA VOKEL    | BOJA | ŠIFRA ARTIKLA | PAKIRANJE |
|----------------|------|---------------|-----------|
| <b>0504100</b> | KROM | 12208         | 1         |



### ECO PRELATOR ŠTEDNI-TRODIJELNI SET

| ŠIFRA VOKEL    | BOJA | ŠIFRA ARTIKLA | PAKIRANJE |
|----------------|------|---------------|-----------|
| <b>0504105</b> | KROM | 19110         | 1         |

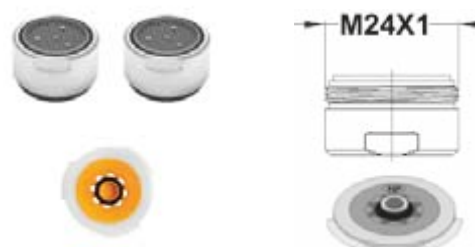

 **Ventili**







| Šifra<br>VOKEL | PRIBOR I REZERVNI DIJELOVI      |               |            | JED.<br>MJERE |
|----------------|---------------------------------|---------------|------------|---------------|
| 12438          | CIJEV PRIKLJUČNA FLEKSIBILNA    | L=400         | ART. 19003 | kom.          |
| 12439          | CIJEV PRIKLJUČNA FLEKSIBILNA    | L=600         | ART. 19004 | kom.          |
| 12004          | CIJEV PRIKLJUČNA KRUTA          | 360/400       | ART. 19011 | par           |
| 12441          | CIJEV PRIKLJUČNA KRUTA S MATIC. | ø 10/442-1/2" | ART. 19022 | par           |
| 12028          | CIJEV GIBLJIVA                  | L=1.500       | ART. 19037 | kom.          |
| 12443          | CIJEV ZA STOJEĆI TUŠ            | ø 18/910      | ART. 19041 | kom.          |
| 12001          | KONZOLA POMIČNA                 | L=620         | ART. 19052 | kom.          |
| 02155          | KONZOLA ZA TUŠ                  |               | ART. 19053 | kom.          |
| 02121          | DRŽAČ ZGLOBNI                   |               | ART. 19065 | kom.          |
| 02122          | DRŽAČ ZIDNI                     |               | ART. 19072 | kom.          |
| 02107          | TUŠ-RUČICA MASAŽNA-KROM         |               | ART. 19084 | kom.          |
| 02156          | TUŠ-RUČICA KROM-ZLATO           |               | ART. 19085 | kom.          |
| 02217          | TUŠ-RUČICA KROM-BIJELA          |               | ART. 19088 | kom.          |
| 02508          | DIO ZA BATERIJU                 |               | ART. 19385 | kom.          |
| 02509          | DIO GORNJI ZA BATERIJU          |               | ART. 19364 | kom.          |
| 02456          | TUŠ-RUČICA                      |               | ART. 19044 | kom.          |
| 02218          | RASPRŠIVAČ SA STOJEĆ. RUČKOM    |               | ART. 19094 | kom.          |
| 02219          | USMJERNIK                       | M 22x1        | ART. 19101 | kom.          |
| 02220          | USMJERNIK                       | M 24x1        | ART. 19102 | kom.          |
| 02221          | USMJERNIK-ZLATO                 | M 22x1        | ART. 19103 | kom.          |
| 02222          | AERATOR                         | M 22x1        | ART. 19111 | kom.          |
| 02223          | AERATOR                         | M 24x1        | ART. 19112 | kom.          |
| 02224          | AERATOR                         | M 28x1        | ART. 19113 | kom.          |
| 02225          | AERATOR ZGLOBNI                 | M 22x1        | ART. 19114 | kom.          |
| 02226          | AERATOR ZGLOBNI                 | M 24x1        | ART. 19115 | kom.          |
| 02227          | AERATOR-ZLATO                   | M 24x1        | ART. 19117 | kom.          |
| 02228          | AERATOR-ZLATOV                  | M 28x1        | ART. 19118 | kom.          |
| 02229          | AERATOR ZGLOBNI-ZLATO           | M 24x1        | ART. 19119 | kom.          |
| 02230          | HOLENDER                        | ø 14          | ART. 19123 | kom.          |
| 02518          | CIJEV ZA TUŠ ANTRACIT           |               | ART. 19039 | kom.          |
| 12445          | CIJEV IZLJEVNA "S"              | ø 13 x 170    | ART. 19131 | kom.          |
| 12446          | CIJEV IZLJEVNA "S"              | ø 13 x 200    | ART. 19132 | kom.          |
| 12447          | CIJEV IZLJEVNA "S"              | ø 13 x 300    | ART. 19133 | kom.          |
| 12448          | CIJEV IZLJEVNA "S"              | ø 18 x 185    | ART. 19141 | kom.          |
| 12449          | CIJEV IZLJEVNA "S"              | ø 18 x 350    | ART. 19142 | kom.          |
| 12450          | CIJEV IZLJEVNA "U"              | ø 13 x 150    | ART. 19151 | kom.          |
| 12451          | CIJEV IZLJEVNA "U"              | ø 18 x 185    | ART. 19161 | kom.          |
| 12452          | CIJEV IZLJEVNA "HU"             | ø 18 x 145    | ART. 19181 | kom.          |
| 12453          | CIJEV IZLJEVNA "HU"             | ø 18 x 145    | ART. 19182 | kom.          |
| 12454          | CIJEV IZLJEVNA ZA AERATOR       |               | ART. 19201 | kom.          |
| 12455          | CIJEV IZLJEVNA ZA USMJERNIK     |               | ART. 19206 | kom.          |
| 12456          | ČEP S LANČIĆEM                  | 5/4"          | ART. 19251 | kom.          |
| 12457          | ČEP S LANČIĆEM                  | 6/4"          | ART. 19252 | kom.          |

| Šifra<br>VOKEL | PRIBOR I REZERVNI DIJELOVI          |         | ART.      | JED.<br>MJERE |
|----------------|-------------------------------------|---------|-----------|---------------|
| 12458          | DRŽAČ ZA TUŠ RUČICU                 |         | ART.19261 | kom.          |
| 04130          | GORNJI DIO VENTILA                  |         | ART.19321 | kom.          |
| 12459          | GORNJI DIO PODŽBUKNOG VENTILA       |         | ART.19331 | kom.          |
| 02049          | GORNJI DIO                          | 3/8"    | ART.19353 | kom.          |
| 02048          | GORNJI DIO                          | 1/2"    | ART.19368 | kom.          |
| 02161          | GORNJI DIO KROM-ZLATO               | 1/2"    | ART.19370 | kom.          |
| 02160          | RUČKA "ELEGANCE" MODRI ISPIS        |         | ART.19374 | kom.          |
| 02140          | RUČKA "ELEGANCE" ZLATNI ISPIS       |         | ART.19375 | kom.          |
| 02231          | GORNJI DIO KROM                     | 1/2"    | ART.19377 | kom.          |
| 02082          | DIO ZA BATERIJE UNITAS              | M'89    | ART.19381 | kom.          |
| 02083          | DIO ZA BATERIJE UNITAS              | M'80    | ART.19383 | kom.          |
| 02084          | DIO ZA BATERIJE UNITAS              | M'92    | ART.19384 | kom.          |
| 02476          | DIO ZA BATERIJE UNITAS              |         | ART.19386 | kom.          |
| 02233          | PREBACIVAČ KROM                     |         | ART.19402 | kom.          |
| 02234          | PREBACIVAČ ZLATO                    |         | ART.19403 | kom.          |
| 02235          | SET DVIJE MATICE I DVIJE BRTVE      | 3/8"    | ART.19451 | kom.          |
| 02236          | SET DVIJE MATICE I DVIJE BRTVE      | 1/2"    | ART.19461 | kom.          |
| 02237          | SET MATICA I BRTVI                  | 1/2"    | ART.19462 | kom.          |
| 02238          | SET MATICA I BRTVI                  | 3/4"    | ART.19471 | kom.          |
| 02142          | ROZETA ZA ELEGANCE-BATERIJE KROM    |         | ART.21021 | kom.          |
| 02244          | ROZETA ZA ELEGANCE-BATERIJE ZLATO   |         | ART.21022 | kom.          |
| 02245          | ROZETA SIFONA                       |         | ART.21031 | kom.          |
| 02246          | DNO SIFONA S MATICOM                |         | ART.21041 | kom.          |
| 02145          | ROZETA ODLJEVNO-PRELJEVNE GARNITURE | ø 70x19 | ART.21051 | kom.          |
| 02144          | KUĆIŠTE ČEPA                        | 5/4"    | ART.21061 | kom.          |
| 02143          | KUĆIŠTE ČEPA                        | 6/4"    | ART.21062 | kom.          |
| 12144          | KAPA PODŽBUKNOG VENTILA             |         | ART.21101 | kom.          |
| 02248          | KAPA VENTILA                        | ø 47    | ART.21111 | kom.          |
| 04260          | EKSCENTAR                           |         | ART.21161 | kom.          |
| 02249          | HOLENDER-MATICA                     | 1"      | ART.21171 | kom.          |
| 02250          | HOLENDER-MATICA                     | 5/4"    | ART.21172 | kom.          |

## BATERIJA ZA UMIVAONIK - MAGNUM

ŠTEDNA BATERIJA S GORNJIM DIJELOM SIFONA



- \* signalizira klik otvaranje na 60%
- \* visina 87 mm do perlatora
- \* limitiran protok na 9 l/min
- \* sa certifikatom europske normative

| ŠIFRA VOKEL    | BOJA | ŠIFRA ARTIKLA | PAKIRANJE |
|----------------|------|---------------|-----------|
| <b>1165001</b> | KROM | 908100        | 1         |

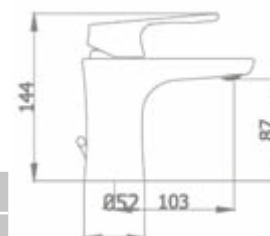

## BATERIJA ZA BIDE

ŠTEDNA BATERIJA S GORNJIM DIJELOM SIFONA



- \* signalizira klik otvaranje na 60%
- \* visina 39,5 mm do perlatora
- \* limitiran protok na 9 l/min
- \* sa certifikatom europske normative

| ŠIFRA VOKEL    | BOJA | ŠIFRA ARTIKLA | PAKIRANJE |
|----------------|------|---------------|-----------|
| <b>1165007</b> | KROM | 917500        | 1         |

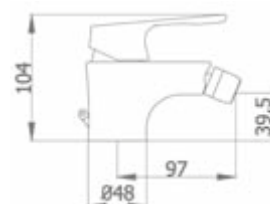

## UGRADNA BATERIJA ZA UMIVAONIK

S PODŽBUKNIM TIJELOM



- \* izljev 200 mm
- \* signalizira klik otvaranje na 60%
- \* limitiran protok na 9 l/min

| ŠIFRA VOKEL    | BOJA | ŠIFRA ARTIKLA | PAKIRANJE |
|----------------|------|---------------|-----------|
| <b>1165008</b> | KROM | 920500        | 1         |

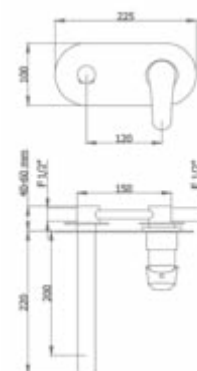

## BATERIJA ZA TUŠ

### ŠTEDNA BATERIJA

- \*dužina 226 mm
- \* signalizira klik otvaranje na 60%



| ŠIFRA VOKEL    | BOJA | ŠIFRA ARTIKLA | PAKIRANJE |
|----------------|------|---------------|-----------|
| <b>1165004</b> | KROM | 3533435       | 1         |

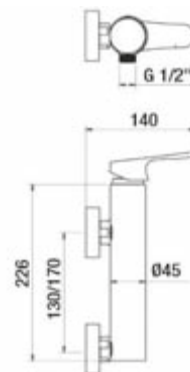

## BATERIJA ZA KADU - SET

### ŠTEDNA BATERIJA

- \*SET: baterija za kadu, winner ručica - 3 stupnja regulacije, konzola, silver crijevo otporno na pregibanje 175 cm
- \* signalizira klik otvaranje na 60%
- \* limitiran protok na 9 l/min



| ŠIFRA VOKEL    | BOJA | ŠIFRA ARTIKLA | PAKIRANJE |
|----------------|------|---------------|-----------|
| <b>1165010</b> | KROM | 35237350      | 1         |

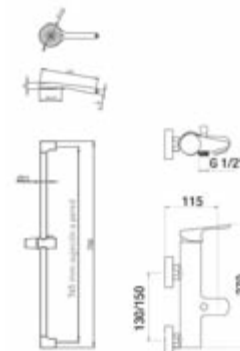

## TERMOSTATSKA BATERIJA ZA KADU - SET

### ŠTEDNA TERMOSTATSKA BATERIJA

- \*SET: termostatska baterija za kadu, winner ručica - 3 stupnja regulacije, konzola, silver crijevo otporno na pregibanje 175 cm
- \*sigurnosni prekidač na 38 °C



| ŠIFRA VOKEL    | BOJA | ŠIFRA ARTIKLA | PAKIRANJE |
|----------------|------|---------------|-----------|
| <b>1165011</b> | KROM | 35216350      | 1         |

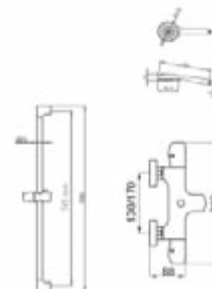

## TERMOSTATSKA BATERIJA ZA TUŠ - SET

### ŠTEDNA TERMOSTATSKA BATERIJA

- \*SET: termostatska baterija za tuš, winner ručica - 3 stupnja regulacije, konzola, silver crijevo otporno na pregibanje 175 cm
- \*sigurnosni prekidač na 38 °C



| ŠIFRA VOKEL    | BOJA | ŠIFRA ARTIKLA | PAKIRANJE |
|----------------|------|---------------|-----------|
| <b>1165009</b> | KROM | 35316350      | 1         |

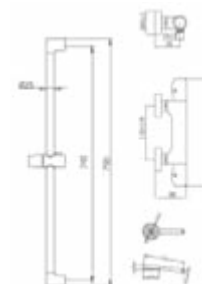





## TERMOSTATSKA BATERIJA ZA TUŠ - RAINSHOWER

### ŠTEDNA TERMOSTATSKA BATERIJA

\*sa fiksnim tušem, winner ručica - 3 stupnja regulacije, silver crijevo otporno na pregibanje 175 cm

\*sigurnosni prekidač na 38 °C

\*rotirajuća tuš ruža Ø250 mm

| ŠIFRA VOKEL    | BOJA | ŠIFRA ARTIKLA | PAKIRANJE |
|----------------|------|---------------|-----------|
| <b>1165002</b> | KROM | 35425350XL    | 1         |

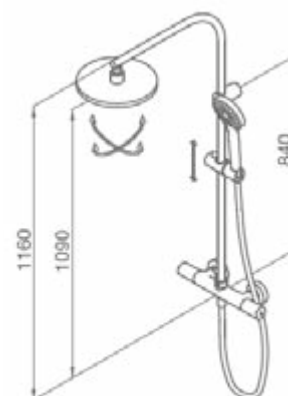

## TERMOSTATSKA BATERIJA ZA TUŠ - RAINSHOWER

### ŠTEDNA TERMOSTATSKA BATERIJA - TELESKOPSKA

\*sa teleskopskim usponom, winner ručica - 3 stupnja regulacije, silver crijevo otporno na pregibanje 175 cm

\*sigurnosni prekidač na 38 °C

\*rotirajuća tuš ruža Ø250 mm

| ŠIFRA VOKEL    | BOJA | ŠIFRA ARTIKLA | PAKIRANJE |
|----------------|------|---------------|-----------|
| <b>1165012</b> | KROM | 35425350TL    | 1         |

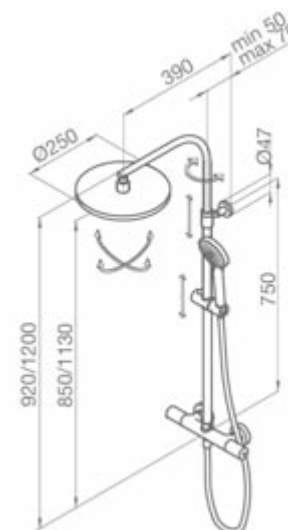



### HIGIJENSKA BATERIJA ZA WC

SA PROGRESIVNO TOPLOM VODOM

- \* progresivna kontrola temperature
- \* silver crijevo otporno na pregibanje 1,25 m
- \* stalni komforan protok vode
- \* lako održavanje

| ŠIFRA VOKEL    | BOJA | ŠIFRA ARTIKLA | PAKIRANJE |
|----------------|------|---------------|-----------|
| <b>1165005</b> | KROM | 08225100      | 1         |

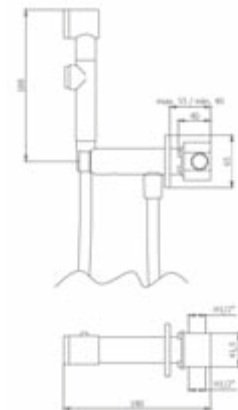

### HIGIJENSKA BATERIJA ZA WC

SA HLADNOM VODOM

- \* jedan dovod vode
- \* crijevo 1,20 m
- \* progresivna kontrola protoka
- \* navoj 1/2"

| ŠIFRA VOKEL    | BOJA | ŠIFRA ARTIKLA | PAKIRANJE |
|----------------|------|---------------|-----------|
| <b>1165006</b> | KROM | 08120100      | 1         |

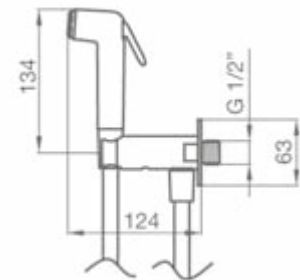

### USPONSKI TUŠ - BEZ BATERIJE

SA TUŠ RUČICOM I TUŠ CRIJEVOM





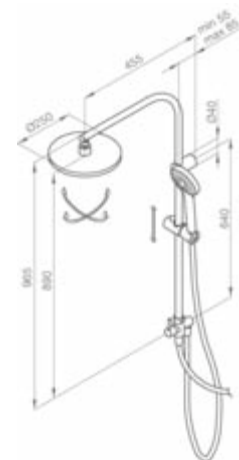

- \* visina 965 mm
- \* rotirajuća tuš ruža Ø250 mm

| ŠIFRA VOKEL    | BOJA | ŠIFRA ARTIKLA | PAKIRANJE |
|----------------|------|---------------|-----------|
| <b>1165003</b> | KROM | 058726        | 1         |





## JEDNORUČNE BATERIJE LANDQUART

|                                                                                     |                |                                                                       |                  |
|-------------------------------------------------------------------------------------|----------------|-----------------------------------------------------------------------|------------------|
|    | <b>1156001</b> | JEDNORUČNA BATERIJA ZA UMIVAONIK LANDQUART                            | ART.9201H659     |
|    | <b>1156002</b> | JEDNORUČNA BATERIJA ZA BIDE LANDQU                                    | ART.9202H659     |
|    | <b>1156003</b> | JEDNORUČNA BATERIJA ZA UMIVAONIK VISOKI IZLJEV<br>LANDQUART           | ART.9201-1H659   |
|   | <b>1156004</b> | JEDNORUČNA BATERIJA ZA KUHINJU LANDQUART                              | ART.9205-2H659   |
|  | <b>1156005</b> | BATERIJA ZA TUŠ LANDQUART S FIKSNIM TUŠEM,<br>CRIJEVOM I RUČICOM      | ART.SC01RS10HS15 |
|  | <b>1156006</b> | BATERIJA ZA KADU/TUŠ LANDQUART S FIKSNIM TUŠEM,<br>CRIJEVOM I RUČICOM | ART.SC05RS02HS15 |



## JEDNORUČNE BATERIJE VOLGA / TAJO / EBRO / SCARPE / DIVE

|                                                                                                   |                |                                                |                |
|---------------------------------------------------------------------------------------------------|----------------|------------------------------------------------|----------------|
|                  | <b>0492028</b> | JEDNORUČNA BATERIJA ZA UMIVAONIK VOLGA         | ART. 0331      |
|                  | <b>0492029</b> | JEDNORUČNA BATERIJA ZA BIDE VOLGA              | ART. 0332      |
|                  | <b>0492030</b> | JEDNORUČNA BATERIJA ZA KADU VOLGA              | ART. 0333      |
|                 | <b>0492031</b> | JEDNORUČNA BATERIJA ZA TUŠ KADU VOLGA          | ART. 0334      |
| <br>S 3 CIJEVI | <b>0492032</b> | JEDNORUČNA BATERIJA ZA KUHINJU S 3 CIJEVI TAJO | ART. 4705-5    |
| <br>S 3 CIJEVI | <b>0492033</b> | JEDNORUČNA BATERIJA ZA KUHINJU S 3 CIJEVI EBRO | ART. 103205-4  |
|                | <b>0492035</b> | JEDNORUČNA BATERIJA ZA KUHINJU SCARPE          | ART.0725H6043  |
|                | <b>0492036</b> | JEDNORUČNA BATERIJA ZA UMIVAONIK DIVE          | ART.0491H401-2 |



## JEDNORUČNE BATERIJE TICINO

|                                                                                     |              |                                             |             |
|-------------------------------------------------------------------------------------|--------------|---------------------------------------------|-------------|
|    | <b>95001</b> | JEDNORUČNA BATERIJA ZA UMIVAONIK TICINO     | ART. 1001   |
|    | <b>95002</b> | JEDNORUČNA BATERIJA ZA BIDE TICINO          | ART. 1002   |
|    | <b>95003</b> | JEDNORUČNA BATERIJA ZA KADU TICINO          | ART. 1003   |
|   | <b>95004</b> | JEDNORUČNA BATERIJA ZA TUŠ KADU TICINO      | ART. 1004   |
|  | <b>95005</b> | JEDNORUČNA BATERIJA ZA KUHINJU TICINO       | ART. 1005   |
|  | <b>95006</b> | JEDNORUČNA BATERIJA ZA KUHINJU TICINO       | ART. 1005-1 |
|  | <b>95007</b> | JEDNORUČNA BATERIJA ZA KUHINJU ZIDNA TICINO | ART. 1006   |
|  | <b>95008</b> | JEDNORUČNA BATERIJA ZA KUHINJU ZIDNA TICINO | ART. 1007   |







## JEDNORUČNE BATERIJE ELBE





|                                                                                     |              |                                           |           |
|-------------------------------------------------------------------------------------|--------------|-------------------------------------------|-----------|
|    | <b>95009</b> | JEDNORUČNA BATERIJA ZA UMIVAONIK ELBE     | ART. 1501 |
|    | <b>95010</b> | JEDNORUČNA BATERIJA ZA BIDE ELBE          | ART. 1502 |
|   | <b>95011</b> | JEDNORUČNA BATERIJA ZA KADU ELBE          | ART. 1503 |
|  | <b>95012</b> | JEDNORUČNA BATERIJA ZA TUŠ KADU ELBE      | ART. 1504 |
|  | <b>95013</b> | JEDNORUČNA BATERIJA ZA KUHINJU ELBE       | ART. 1505 |
|  | <b>95014</b> | JEDNORUČNA BATERIJA ZA KUHINJU ZIDNA ELBE | ART. 1506 |
|  | <b>95015</b> | JEDNORUČNA BATERIJA ZA KUHINJU ZIDNA ELBE | ART. 1507 |









## JEDNORUČNE BATERIJE THAMES

|                                                                                   |              |                                         |           |
|-----------------------------------------------------------------------------------|--------------|-----------------------------------------|-----------|
|  | <b>95016</b> | JEDNORUČNA BATERIJA ZA UMIVAONIK THAMES | ART. 3201 |
|  | <b>95017</b> | JEDNORUČNA BATERIJA ZA BIDE THAMES      | ART. 3202 |
|  | <b>95018</b> | JEDNORUČNA BATERIJA ZA KADU THAMES      | ART. 3203 |

## LOIRE

|                                                                                     |              |                                        |           |
|-------------------------------------------------------------------------------------|--------------|----------------------------------------|-----------|
|  | <b>95019</b> | JEDNORUČNA BATERIJA ZA UMIVAONIK LOIRE | ART. 3301 |
|  | <b>95020</b> | JEDNORUČNA BATERIJA ZA BIDE LOIRE      | ART. 3302 |
|  | <b>95021</b> | JEDNORUČNA BATERIJA ZA KADU LOIRE      | ART. 3303 |
|  | <b>95022</b> | JEDNORUČNA BATERIJA ZA KUHINJU LOIRE   | ART. 3305 |

|                                                                                     |              |                                                                                                |
|-------------------------------------------------------------------------------------|--------------|------------------------------------------------------------------------------------------------|
|    | <b>95024</b> | MASAŽER S BATERIJOM<br><br>ART. 1111                                                           |
|    | <b>95028</b> | KROMIRANA KONZOLA ZA TUŠ S CRIJEVOM, RUČICOM I DRŽAČEM ZA SAPUN<br><br>ART. S138 + 2007 + HOSE |
|   | <b>95033</b> | KROMIRANA RUČICA ZA TUŠ<br><br>ART. S268                                                       |
|  | <b>95036</b> | KROMIRANA RUČICA ZA TUŠ<br><br>ART. S535                                                       |
|  | <b>95037</b> | KROMIRANA RUČICA ZA TUŠ<br><br>ART. S106                                                       |
|  | <b>95038</b> | KROMIRANA RUČICA ZA TUŠ<br><br>ART. S558                                                       |
|  | <b>95039</b> | KROMIRANA TUŠ RUČICA ZA KUHINJU<br><br>ART. S100                                               |

|                                                                                     |              |                                                                 |
|-------------------------------------------------------------------------------------|--------------|-----------------------------------------------------------------|
|    | <b>95040</b> | KROMIRANA KONZOLA ZA TUŠ 660 mm S DRŽAČEM ZA SAPUN<br>ART. 2013 |
|   | <b>95041</b> | KROMIRANA KONZOLA ZA TUŠ 660 mm S DRŽAČEM ZA SAPUN<br>ART. 2015 |
|  | <b>95042</b> | KROMIRANA KONZOLA ZA TUŠ 660 mm S DRŽAČEM SAPUNA<br>ART. 2018   |
|  | <b>95044</b> | KROMIRANO CRIJEVO ZA TUŠ 150 cm<br>ART. H3001                   |
|  | <b>95045</b> | KROMIRANO CRIJEVO ZA TUŠ 150 cm<br>ART. H3002                   |
|  | <b>95047</b> | KROMIRANO CRIJEVO ZA TUŠ 150 cm<br>ART. H3006                   |



|                                                                                    |              |                                              |            |
|------------------------------------------------------------------------------------|--------------|----------------------------------------------|------------|
|   | <b>95056</b> | PVC DOZATOR ZA TEKUĆI SAPUN                  | ART. L818A |
|   | <b>95057</b> | PVC DOZATOR ZA TEKUĆI SAPUN                  | ART. L818B |
|  | <b>95058</b> | ULOŽAK (KARTUŠA) Ø 35 ZA JEDNORUČNU BATERIJU | ART. C201  |
|                                                                                    | <b>95059</b> | ULOŽAK (KARTUŠA) Ø 40 ZA JEDNORUČNU BATERIJU | ART. C201  |



|                                                                                     |                |                                                                               |               |
|-------------------------------------------------------------------------------------|----------------|-------------------------------------------------------------------------------|---------------|
|    | <b>97001</b>   | SENZORSKA BATERIJA ZA UMIVAONIK S BATERIJOM 9V                                | Mod.SLU 02NB  |
|                                                                                     | <b>97002</b>   | SENZORSKA BATERIJA ZA UMIVAONIK, VANJSKO NAPAJSANJE TRAF0 24V                 | Mod.SLU 02N   |
|    | <b>97003</b>   | SENZORSKA BATERIJA ZA PISOAR PODŽBUKNA, VANJSKO NAPAJSANJE TRAF0 24V          | Mod.SLP 02K   |
|                                                                                     | <b>97010</b>   | SENZORSKA BATERIJA ZA PISOAR PODŽBUKNA S UNUTARNJIM NAPAJSANJEM 9V-BATERIJSKA | Mod.SLP 06K   |
|    | <b>97004</b>   | SENZORSKA BATERIJA ZA WC, VANJSKO NAPAJSANJE TRAF0 24V                        | Mod.SLW 01NK  |
|    | <b>97005</b>   | SENZORSKA BATERIJA ZA PISOAR , BATERIJSKA 9V                                  | Mod.SLP 09    |
|  | <b>0495026</b> | TRAF0 24V (1 BATERIJA)                                                        | Mod.SLZ 06    |
|                                                                                     | <b>97006</b>   | TRAF0 24V (1-2 BATERIJE)                                                      | Mod.SLZ 01Y   |
|                                                                                     | <b>0495025</b> | TRAF0 24V (1-4 BATERIJE)                                                      | Mod.SLZ 01Z   |
|  | <b>97007</b>   | BATERIJA 9V/1300mAh Tip.U9VL                                                  | Mod.SLA 09    |
|  | <b>97008</b>   | DALJINSKI UPRAVLJAČ ZA PODEŠAVANJE SVIH PROGRAMA SENZORSKIH BATERIJA          | Mod. SLD 03   |
|  | <b>0495027</b> | DALJINSKI UPRAVLJAČ ZA PODEŠAVANJE PROGRAMA KOD RADARSKIH ISPIRAČA PISOARA    | Mod. SLD 04   |
|  | <b>0495028</b> | RADARSKI ISPIRAČ ZA INKEROV PISOAR                                            | Mod. SLP 35Z  |
|                                                                                     | <b>0495031</b> | RADARSKI ISPIRAČ ZA PISOAR VOLGA                                              | Mod. SLP 39RZ |
|  | <b>0495029</b> | INOX SITO ZA PISOAR                                                           | Mod. SLA 10   |
|  | <b>0495030</b> | PLASTIČNO SITO ZA PISOAR                                                      | Mod. SLA 11   |

|                                                                                     |                                                  |                                     |             |
|-------------------------------------------------------------------------------------|--------------------------------------------------|-------------------------------------|-------------|
|    | <b>ZIDNI INOX UMIVAONIK S OTVOROM ZA SLAVINU</b> |                                     |             |
|                                                                                     | <b>0495033</b>                                   | INOX UMIVAONIK S OTVOROM ZA SLAVINU | Mod.SLUN 26 |
|    | <b>WC INOX ČUČAVAC S DVIJE MLAZNICE</b>          |                                     |             |
|                                                                                     | <b>0495034</b>                                   | WC INOX ČUČAVAC S DVIJE MLAZNICE    | Mod:SLWN 07 |
|   | <b>INOX PISOAR S MLAZNICOM</b>                   |                                     |             |
|                                                                                     | <b>0495035</b>                                   | INOX PISOAR S MLAZNICOM             | Mod.SLPN 07 |
|  | <b>VISEĆA INOX WC ŠKOLJKA</b>                    |                                     |             |
|                                                                                     | <b>0495036</b>                                   | VISEĆA INOX WC ŠKOLJKA              | Mod.SLWN 04 |
|  | <b>PROTUKLIZNA INOX TUŠ KADA</b>                 |                                     |             |
|                                                                                     | <b>0495037</b>                                   | PROTUKLIZNA INOX TUŠ KADA           | Mod.SLSN 06 |

**REZERVNI DIJELOVI**

|                |                                                                                                   |
|----------------|---------------------------------------------------------------------------------------------------|
| <b>0495053</b> | ELEKTROMAGNETNI VENTIL VE-RPE4115 3/8" 24 V (ZA BATERIJE SLP35RZ, SLP39RZ, SLU02N, SLU15, SLP02K) |
| <b>0495054</b> | ELEKTROMAGNETNI VENTIL VE-RPE4115 3/8" 6 V BISTABILNI (ZA BATERIJE SLP06K)                        |
| <b>0495055</b> | ELEKTROMAGNETNI VENTIL VE-050-B07 6 V (ZA BATERIJE SLU02NB)                                       |
| <b>0495056</b> | SENZOR ZA BATERIJE SLU01NB,02NB, 29B Mod.E-SL297AC                                                |

DRŽAČI SERIJA  
EXPORT 2200



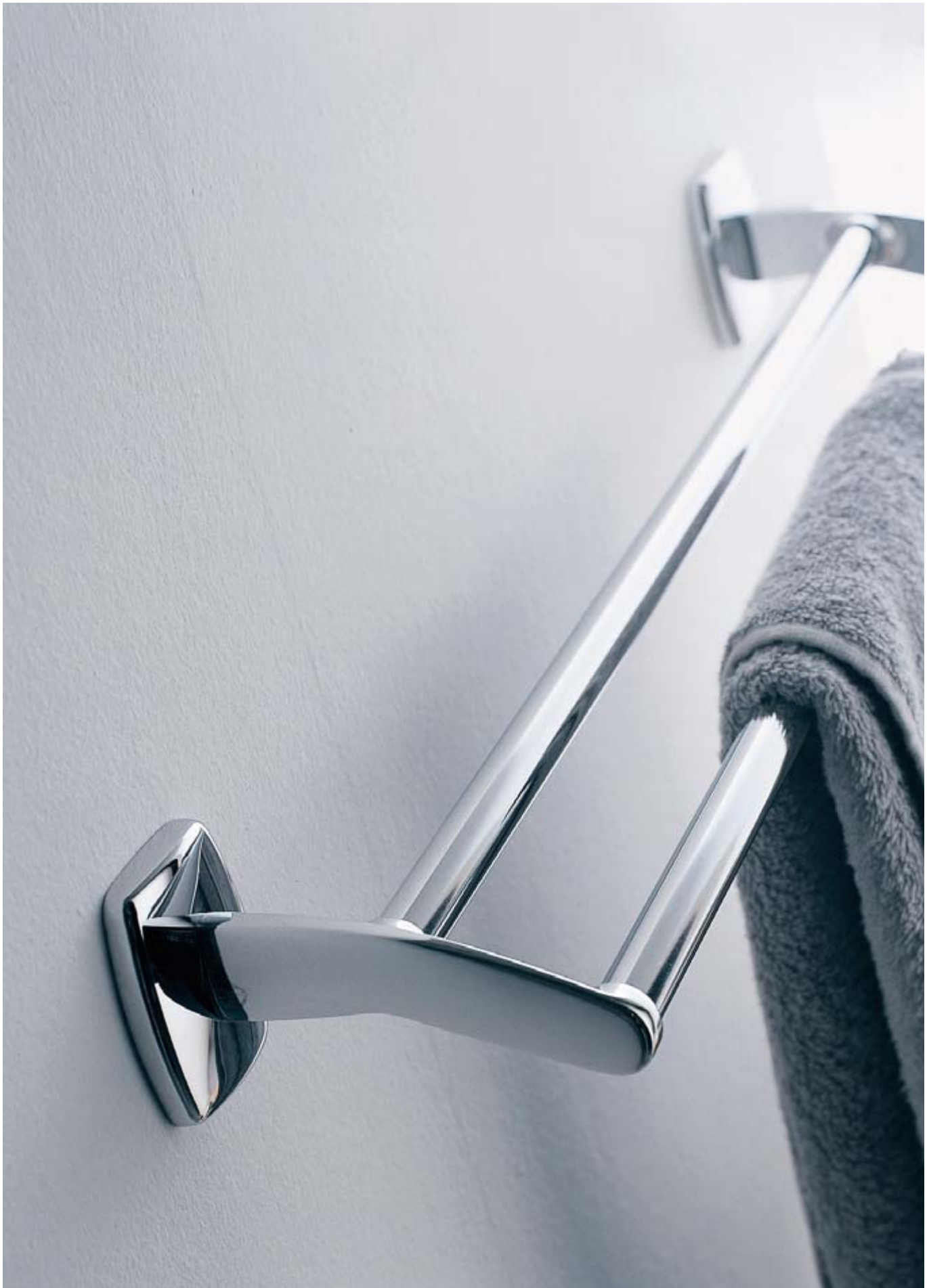





**DRŽAČ POLICE I POLICA**  
cm 60 x 7H x 14

| Šifra<br>VOKEL | Boja | Broj<br>Artikla | Pakovanje<br>KOM |
|----------------|------|-----------------|------------------|
| 42397          | KROM | A2207F CR 01    | 1                |



**DRŽAČ TOALET PAPIRA**  
HORIZONTALNI

| Šifra<br>VOKEL | Boja | Broj<br>Artikla | Pakovanje<br>KOM |
|----------------|------|-----------------|------------------|
| 42001          | KROM | A22250 CR 003   | 10               |



**DRŽAČ TOALET PAPIRA**  
VERTIKALNI

| Šifra<br>VOKEL | Boja | Broj<br>Artikla | Pakovanje<br>KOM |
|----------------|------|-----------------|------------------|
| 42002          | KROM | A22280 CR 003   | 10               |



**DRŽAČ TOALET PAPIRA**

| Šifra<br>VOKEL | Boja | Broj<br>Artikla | Pakovanje<br>KOM |
|----------------|------|-----------------|------------------|
| 11349          | KROM | A22260 CR 003   | 10               |



**DRŽAČ TOALET PAPIRA**

| Šifra<br>VOKEL | Boja | Broj<br>Artikla | Pakovanje<br>KOM |
|----------------|------|-----------------|------------------|
| 42020          | KROM | A22290 AL 003   | 10               |



**DRŽAČ RUČNIKA**  
OKRUGLI

| Šifra<br>VOKEL | Boja | Broj<br>Artikla | Pakovanje<br>KOM |
|----------------|------|-----------------|------------------|
| 11346          | KROM | A2216T CR 003   | 10               |



**DRŽAČ RUČNIKA**  
TRAPEZ

| Šifra<br>VOKEL | Boja | Broj<br>Artikla | Pakovanje<br>KOM |
|----------------|------|-----------------|------------------|
| 11387          | KROM | A22160 CR 003   | 10               |



**DRŽAČ RUČNIKA FIKSNI**

| Šifra<br>VOKEL | Širina | Boja | Broj<br>Artikla | Pakovanje<br>KOM |
|----------------|--------|------|-----------------|------------------|
| 11345          | 30 cm  | KROM | A2290A CR       | 10               |
| 11344          | 45 cm  | KROM | A2290B CR       | 10               |
| 11343          | 60 cm  | KROM | A2290C CR       | 10               |





**DRŽAČ RUČNIKA  
DVODJELNI FIKSNI**

| Šifra<br>VOKEL | Širina | Boja | Broj<br>Artikla | Pakovanje<br>KOM |
|----------------|--------|------|-----------------|------------------|
| 42071          | 45 cm  | KROM | A2291B CR       | 1                |
| 11805          | 60 cm  | KROM | A2291C CR       | 1                |



**DRŽAČ RUČNIKA POKRETNI 2/1  
cm 43 x 7H x 5**

| Šifra<br>VOKEL | Boja | Broj<br>Artikla | Pakovanje<br>KOM |
|----------------|------|-----------------|------------------|
| 11350          | KROM | A22150 CR 003   | 10               |



**RUKOHVAT  
cm 32 x 7H x 8**

| Šifra<br>VOKEL | Boja | Broj<br>Artikla | Pakovanje<br>KOM |
|----------------|------|-----------------|------------------|
| 11341          | KROM | A0590M CR 007   | 10               |



**VJEŠALICA ZA RUČNIKE 3/1  
cm 29 x 4H x 5**

| Šifra<br>VOKEL | Boja | Broj<br>Artikla | Pakovanje<br>KOM |
|----------------|------|-----------------|------------------|
| 11339          | KROM | A12253 CR 003   | 15               |



**VJEŠALICA 1/1  
cm 5 x 7H x 6**

| Šifra<br>VOKEL | Boja | Broj<br>Artikla | Pakovanje<br>KOM |
|----------------|------|-----------------|------------------|
| 11348          | KROM | A22200 CR 003   | 20               |



**VJEŠALICA 2/1  
cm 8 x 7H x 6**

| Šifra<br>VOKEL | Boja | Broj<br>Artikla | Pakovanje<br>KOM |
|----------------|------|-----------------|------------------|
| 11052          | KROM | A22210 CR 003   | 15               |



**DRŽAČ ČAŠE DUPLI  
I STAKLENE ČAŠE**

| Šifra<br>VOKEL | Opis  | Boja | Broj<br>Artikla | Pakovanje<br>KOM |
|----------------|-------|------|-----------------|------------------|
| 42873          | DRŽAČ | KROM | A2217N CR 003   | 10               |
| 11814          | ČAŠA  | -    | R03600          | 1                |



**DRŽAČ ČAŠE  
I STAKLENA ČAŠA**

| Šifra<br>VOKEL | Opis    | Boja | Broj<br>Artikla | Pakovanje<br>KOM |
|----------------|---------|------|-----------------|------------------|
| 0468223        | KOMPLET | KROM | A22100 CR 003   | 1                |
| 11428          | DRŽAČ   | KROM | A2210N CR 003   | 1                |
| 11814          | ČAŠA    | -    | R03600          | 1                |



**DRŽAČ SAPUNA  
I STAKLENA SAPUNICA**

| Šifra<br>VOKEL | Opis         | Boja      | Broj<br>Artikla | Pakovanje<br>KOM |    |
|----------------|--------------|-----------|-----------------|------------------|----|
| 0468225        | KOMPLET KROM | A22110 CR | 003             | 1                |    |
| 11428          | DRŽAČ        | KROM      | A2210N CR       | 003              | 10 |
| 11429          | SAPUNICA     | -         | R03110          | 1                |    |



**DRŽAČ SAPUNA  
cm 14 x 7H x 11**

| Šifra<br>VOKEL | Boja | Broj<br>Artikla | Pakovanje<br>KOM |    |
|----------------|------|-----------------|------------------|----|
| 11005          | KROM | A22490 CR       | 003              | 10 |



**DRŽAČ SPUŽVE I SAPUNA  
cm 24 x 7H x 14**

| Šifra<br>VOKEL | Boja | Broj<br>Artikla | Pakovanje<br>KOM |    |
|----------------|------|-----------------|------------------|----|
| 11386          | KROM | A22510 CR       | 003              | 10 |



**KUTNI ETAŽER  
cm 17 x 31H x 18**

| Šifra<br>VOKEL | Boja | Broj<br>Artikla | Pakovanje<br>KOM |   |
|----------------|------|-----------------|------------------|---|
| 42004          | KROM | A04320 AL       | 02               | 1 |



**WC ČETKA**

| Šifra<br>VOKEL | Boja | Broj<br>Artikla | Pakovanje<br>KOM |
|----------------|------|-----------------|------------------|
| 42005          | KROM | A05140 CR       | 1                |



**WC ČETKA**

| Šifra<br>VOKEL | Boja | Broj<br>Artikla | Pakovanje<br>KOM |
|----------------|------|-----------------|------------------|
| 11384          | KROM | A07140 WW       | 1                |



**OGLEDALO**  
**cm 23 x 27H x 35**

| Šifra<br>VOKEL | Boja | Broj<br>Artikla | Pakovanje<br>KOM |
|----------------|------|-----------------|------------------|
| 0468279        | KROM | AV058 C CR      | 1                |
| 11922          | KROM | AV058 A CR      | 1                |



**KUTIJA ZA PAPIR**  
**cm 27 x 14H x 7**

| Šifra<br>VOKEL | Boja | Broj<br>Artikla | Pakovanje<br>KOM |
|----------------|------|-----------------|------------------|
| 11807          | KROM | A07250 AL       | 1                |

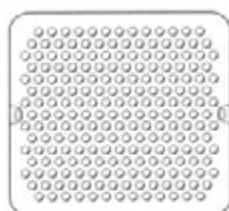

**PODMETAČ ZA TUŠ**  
**55 x 55 cm**

| Šifra<br>VOKEL | Boja | Broj<br>Artikla | Pakovanje<br>KOM |
|----------------|------|-----------------|------------------|
| 11806          | -    | A0198 BWW 005   | 1                |

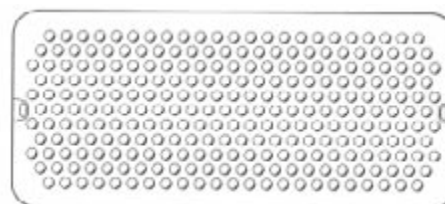

**PODMETAČ ZA TUŠ**  
**90 x 40 cm**

| Šifra<br>VOKEL | Boja | Broj<br>Artikla | Pakovanje<br>KOM |
|----------------|------|-----------------|------------------|
| 11903          | -    | A0199 BWW 005   | 1                |





DRŽAČI SERIJA  
HOTELLERIE









**RUKOHVAT ZA INVALIDE**  
cm 43 x 22H x 12 (~ 150 kg)

| Šifra<br>VOKEL | Boja | Broj<br>Artikla | Pakovanje<br>KOM |
|----------------|------|-----------------|------------------|
| 42085          | KROM | A0491T CR 007   | 10               |



**DRŽAČ SAPUNA**

| Šifra<br>VOKEL | Boja | Broj<br>Artikla | Pakovanje<br>KOM |
|----------------|------|-----------------|------------------|
| 11930          | KROM | A0492T CR 007   | 10               |



**DRŽAČ RUČNIKA**  
cm 57 x 7H x 22

| Šifra<br>VOKEL | Boja | Broj<br>Artikla | Pakovanje<br>KOM |
|----------------|------|-----------------|------------------|
| 11929          | KROM | A04680 CR       | 1                |



**DRŽAČ RUČNIKA**  
cm 67 x 13H x 28

| Šifra<br>VOKEL | Boja | Broj<br>Artikla | Pakovanje<br>KOM |
|----------------|------|-----------------|------------------|
| 42867          | KROM | A04690 CR       | 1                |



**DRŽAČ RUČNIKA**  
cm 22 x 16H x 3

| Šifra<br>VOKEL | Boja | Broj<br>Artikla | Pakovanje<br>KOM |
|----------------|------|-----------------|------------------|
| 42012          | KROM | A04160 CR 007   | 10               |



**DRŽAČ TOALET PAPIRA  
DUPLI**

| Šifra<br>VOKEL | Boja | Broj<br>Artikla | Pakovanje<br>KOM |
|----------------|------|-----------------|------------------|
| 0468271        | KROM | AV426E CR       | 1                |



**DRŽAČ TOALET PAPIRA**  
cm 13 x 10H x 10

| Šifra<br>VOKEL | Boja | Broj<br>Artikla | Pakovanje<br>KOM |
|----------------|------|-----------------|------------------|
| 42009          | KROM | A3827A CR 007   | 10               |



**DRŽAČ TOALET PAPIRA DUPLI**  
cm 16 x 19H x 11

| Šifra<br>VOKEL | Boja | Broj<br>Artikla | Pakovanje<br>KOM |
|----------------|------|-----------------|------------------|
| 42015          | KROM | AV425B CR       | 1                |



**VJEŠALICA**  
Ø 2 x 3

| Šifra<br>VOKEL | Boja | Broj<br>Artikla | Pakovanje<br>KOM |
|----------------|------|-----------------|------------------|
| 11905          | KROM | A05610 CR 007   | 10               |



**DRŽAČ SAPUNA**  
cm 13 x 7H x 11

| Šifra<br>VOKEL | Boja | Broj<br>Artikla | Pakovanje<br>KOM |
|----------------|------|-----------------|------------------|
| 11907          | KROM | A04110 CR 007   | 10               |



**DRŽAČ SAPUNA**  
cm 13 x 3H x 9

| Šifra<br>VOKEL | Boja | Broj<br>Artikla | Pakovanje<br>KOM |
|----------------|------|-----------------|------------------|
| 42011          | KROM | A04090 CR       | 1                |



**DRŽAČ SAPUNA REŠETKASTI**  
cm 13 x 4H x 10

| Šifra<br>VOKEL | Boja | Broj<br>Artikla | Pakovanje<br>KOM |
|----------------|------|-----------------|------------------|
| 11909          | KROM | A04500 CR 007   | 10               |



**DRŽAČ SAPUNA REŠETKASTI**  
cm 20 x 7H x 13

| Šifra<br>VOKEL | Boja | Broj<br>Artikla | Pakovanje<br>KOM |
|----------------|------|-----------------|------------------|
| 11910          | KROM | A0451H CR 007   | 10               |

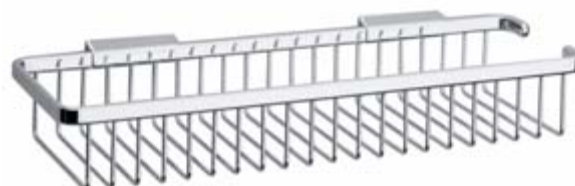

**DRŽAČ SAPUNA REŠETKASTI**  
cm 39 x 7H x 14

| Šifra<br>VOKEL | Boja | Broj<br>Artikla | Pakovanje<br>KOM |
|----------------|------|-----------------|------------------|
| 11911          | KROM | A0453H CR       | 1                |



**VJEŠALICA**  
cm 19 x 4H x 4

| Šifra<br>VOKEL | Boja | Broj<br>Artikla | Pakovanje<br>KOM |
|----------------|------|-----------------|------------------|
| 11904          | KROM | A38240 CR 007   | 10               |



**VJEŠALICA**  
cm 5 x 7H x 5

| Šifra<br>VOKEL | Boja | Broj<br>Artikla | Pakovanje<br>KOM |
|----------------|------|-----------------|------------------|
| 11906          | KROM | A05620 CR 003   | 5                |



**PEPELJARA**  
*cm 11 x 2H x 7*

| Šifra<br>VOKEL | Boja | Broj<br>Artikla | Pakovanje<br>KOM |
|----------------|------|-----------------|------------------|
| 42014          | KROM | A05300 CR 03    | 1                |



**SUŠILO ZA KOSU SA UTIČNICOM**  
*cm 19 x 54H x 10 (1200 W)*

| Šifra<br>VOKEL | Boja   | Broj<br>Artikla | Pakovanje<br>KOM |
|----------------|--------|-----------------|------------------|
| 42017          | BIJELO | AV454B WW       | 1                |



**SUŠILO ZA KOSU BEZ UTIČNICE**  
*cm 19 x 54H x 10 (1200 W)*

| Šifra<br>VOKEL | Boja   | Broj<br>Artikla | Pakovanje<br>KOM |
|----------------|--------|-----------------|------------------|
| 42157          | BIJELO | AV454A WW       | 1                |



**SUŠILO ZA KOSU**  
*(200/800/1600 W)*

| Šifra<br>VOKEL | Boja        | Broj<br>Artikla | Pakovanje<br>KOM |
|----------------|-------------|-----------------|------------------|
| 42019          | KROM-BIJELO | AV054B WC       | 1                |



**SUŠILO ZA KOSU**  
*(150/600/1200 W)*

| Šifra<br>VOKEL | Boja   | Broj<br>Artikla | Pakovanje<br>KOM |
|----------------|--------|-----------------|------------------|
| 42013          | BIJELO | A04520 WW       | 1                |



**KANTICA ZA SMEĆE**  
cm 21 x 29H x 28 - 5 litara

| Šifra<br>VOKEL | Boja | Broj<br>Artikla | Pakovanje<br>KOM |
|----------------|------|-----------------|------------------|
| 11356          | KROM | A04025 AL       | 1                |



**KANTICA ZA SMEĆE**  
Ø 22 x 34H - 10 litara

| Šifra<br>VOKEL | Boja | Broj<br>Artikla | Pakovanje<br>KOM |
|----------------|------|-----------------|------------------|
| 42154          | KROM | AV4010 AL       | 1                |



**DOZATOR ZA TEKUĆI SAPUN  
SA KLJUČEM**  
cm 12 x 30H x 15 - 1 litar

| Šifra<br>VOKEL | Boja | Broj<br>Artikla | Pakovanje<br>KOM |
|----------------|------|-----------------|------------------|
| 42018          | KROM | AV4670 AL       | 1                |



**KANTICA ZA SMEĆE**  
Ø 22 x 25H - 7 litara

| Šifra<br>VOKEL | Boja | Broj<br>Artikla | Pakovanje<br>KOM |
|----------------|------|-----------------|------------------|
| 42007          | KROM | A0401C AL       | 1                |



**STOLICA ZA KUPATILO**  
Ø 31 x 42H

| Šifra<br>VOKEL | Boja | Broj<br>Artikla | Pakovanje<br>KOM |
|----------------|------|-----------------|------------------|
| 42208          | KROM | A03750 CR       | 1                |





**ETAŽER SA PREGRADAMA**  
cm 16 x 26H x 12

| Šifra<br>VOKEL | Boja | Broj<br>Artikla | Pakovanje<br>KOM |
|----------------|------|-----------------|------------------|
| 11385          | KROM | A0467N CR       | 1                |



**ETAŽER KUTNI REŠETKASTI**  
cm 16 x 4H x 16

| Šifra<br>VOKEL | Boja | Broj<br>Artikla | Pakovanje<br>KOM |
|----------------|------|-----------------|------------------|
| 42129          | KROM | A04490 CR 007   | 10               |



**ETAŽER KUTNI**

| Šifra<br>VOKEL | Boja     | Broj<br>Artikla | Pakovanje<br>KOM |
|----------------|----------|-----------------|------------------|
| 0468278        | ALUMINIJ | A04310 AL 02    | 1                |



**DOZATOR ZA TEKUĆI SAPUN**

| Šifra<br>VOKEL | Litara | Boja | Broj<br>Artikla | Pakovanje<br>KOM |
|----------------|--------|------|-----------------|------------------|
| 11094          | 0,5    | KROM | A05670 CR       | 1                |
| 77012          | 1      | KROM | A05671 CR       | 1                |



**DOZATOR ZA TEKUĆI SAPUN  
PODPULTNI**  
cm 7 x 37H x 13 - 0,75 litara

| Šifra<br>VOKEL | Boja | Broj<br>Artikla | Pakovanje<br>KOM |
|----------------|------|-----------------|------------------|
| 42010          | KROM | A0407A CR       | 1                |



**DRŽAČ ČAŠE I ČAŠA**  
cm 7 x 11H x 10

| Šifra<br>VOKEL | Boja | Broj<br>Artikla | Pakovanje<br>KOM |
|----------------|------|-----------------|------------------|
| 11908          | KROM | A04100 CR 003   | 1                |





DRŽAČI SERIJA  
TOUCH





**DRŽAČ RUČNIKA DUPLI**  
cm 66 x 5H x 8

| Šifra<br>VOKEL | Boja | Broj<br>Artikla | Pakovanje<br>KOM |
|----------------|------|-----------------|------------------|
| 42925          | KROM | A4618C CR       | 1                |



**DRŽAČ RUČNIKA**  
cm 66 x 5H x 8

| Šifra<br>VOKEL | Boja | Broj<br>Artikla | Pakovanje<br>KOM |
|----------------|------|-----------------|------------------|
| 42926          | KROM | A4618G CR       | 1                |



**DRŽAČ RUČNIKA KRUŽNI**  
cm 22 x 24H x 8

| Šifra<br>VOKEL | Boja | Broj<br>Artikla | Pakovanje<br>KOM |
|----------------|------|-----------------|------------------|
| 42924          | KROM | A46160 CR       | 1                |



**DRŽAČ TOALET PAPIRA DUPLI**  
cm 34 x 5H x 8

| Šifra<br>VOKEL | Boja | Broj<br>Artikla | Pakovanje<br>KOM |
|----------------|------|-----------------|------------------|
| 42929          | KROM | A46252 CR       | 1                |



**UNIVERZALNI DRŽAČ**  
cm 47 x 70H x 39

| Šifra<br>VOKEL | Boja | Broj<br>Artikla | Pakovanje<br>KOM |
|----------------|------|-----------------|------------------|
| 42931          | KROM | A46830 CR       | 1                |



**WC ČETKA**  
cm Ø 9 x 40H

| Šifra<br>VOKEL | Boja | Broj<br>Artikla | Pakovanje<br>KOM |
|----------------|------|-----------------|------------------|
| 0468275        | KROM | AV014A CR       | 1                |



**VJEŠALICA**  
*cm Ø 5 x 5*

| Šifra<br>VOKEL | Boja | Broj<br>Artikla | Pakovanje<br>KOM |
|----------------|------|-----------------|------------------|
| 42927          | KROM | A46200 CR       | 1                |



**DRŽAČ ČAŠE**  
**I STAKLENA ČAŠA**

| Šifra<br>VOKEL | Opis         | Boja | Broj<br>Artikla | Pakovanje<br>KOM |
|----------------|--------------|------|-----------------|------------------|
| 42921          | KOMPLET KROM |      | A46100 CR 21    | 1                |
| 42959          | ČAŠA         | -    | R46100          | 1                |



**DRŽAČ SAPUNA**  
**I STAKLENA SAPUNICA**

| Šifra<br>VOKEL | Opis         | Boja | Broj<br>Artikla | Pakovanje<br>KOM |
|----------------|--------------|------|-----------------|------------------|
| 0468186        | KOMPLET KROM |      | A46110 CR 21    | 1                |
| 42960          | SAPUNICA     | -    | R46110          | 1                |



**DOZATOR ZA TEKUĆI SAPUN**  
**I DRŽAČ**

| Šifra<br>VOKEL | Opis         | Boja | Broj<br>Artikla | Pakovanje<br>KOM |
|----------------|--------------|------|-----------------|------------------|
| 42930          | KOMPLET KROM |      | A46670 CR 21    | 1                |
| 77001          | DOZATOR      | -    | A4667A          | 1                |



DRŽAČI SERIJA  
EGO 1300







**RUKOHVAT**  
**cm 35 x 3H x 7 (~ 150 kg)**

| Šifra<br>VOKEL | Boja | Broj<br>Artikla | Pakovanje<br>KOM |
|----------------|------|-----------------|------------------|
| 0468234        | KROM | A13950 CR       | 1                |



**RUKOHVAT**  
**cm 50 x 3H x 7 (~ 120 kg)**

| Šifra<br>VOKEL | Boja | Broj<br>Artikla | Pakovanje<br>KOM |
|----------------|------|-----------------|------------------|
| 0468233        | KROM | A1390B CR       | 1                |



**DRŽAČ ČAŠE SA ČAŠOM**  
**cm 8 x 13H x 9**

| Šifra<br>VOKEL | Boja | Broj<br>Artikla | Pakovanje<br>KOM |
|----------------|------|-----------------|------------------|
| 0468231        | KROM | A1310A CR 21    | 1                |



**DRŽAČ SA ČAŠOM I DOZATOROM**  
**cm 21 x 16H x 10**

| Šifra<br>VOKEL | Boja | Broj<br>Artikla | Pakovanje<br>KOM |
|----------------|------|-----------------|------------------|
| 0468229        | KROM | A1310D CR 21    | 1                |



**DRŽAČ SAPUNA SA SAPUNICOM**  
**cm 14 x 8H x 13**

| Šifra<br>VOKEL | Boja | Broj<br>Artikla | Pakovanje<br>KOM |
|----------------|------|-----------------|------------------|
| 0468230        | KROM | A1311A CR 21    | 1                |





**VJEŠALICA 1/1**

| Šifra<br>VOKEL | cm    | Boja | Broj<br>Artikla | Pakovanje<br>KOM |
|----------------|-------|------|-----------------|------------------|
| 0468226        | Ø 3x4 | KROM | A1320A CR       | 1                |
| 0468227        | Ø 3x7 | KROM | A1320B CR       | 1                |



**VJEŠALICA 1/1**  
**cm 3 x 7H x 4**

| Šifra<br>VOKEL | Boja | Broj<br>Artikla | Pakovanje<br>KOM |
|----------------|------|-----------------|------------------|
| 0468228        | KROM | A1320C CR       | 1                |



**DRŽAČ TOALET PAPIRA**  
**cm 3 x 16H x 8**

| Šifra<br>VOKEL | Boja | Broj<br>Artikla | Pakovanje<br>KOM |
|----------------|------|-----------------|------------------|
| 0468235        | KROM | A1328A CR       | 1                |



**DRŽAČ TOALET PAPIRA**  
**cm 16 x 8H x 12**

| Šifra<br>VOKEL | Boja | Broj<br>Artikla | Pakovanje<br>KOM |
|----------------|------|-----------------|------------------|
| 0468236        | KROM | AV426F CR       | 1                |





**DRŽAČ RUČNIKA OKRUGLI**  
*cm 21 x 21H x 8*

| Šifra<br>VOKEL | Boja | Broj<br>Artikla | Pakovanje<br>KOM |
|----------------|------|-----------------|------------------|
| 0468190        | KROM | A33160 CR       | 1                |



**DRŽAČ RUČNIKA FIKSNI**  
*cm 36 x 3H x 8*

| Šifra<br>VOKEL | Boja | Broj<br>Artikla | Pakovanje<br>KOM |
|----------------|------|-----------------|------------------|
| 0468198        | KROM | A3318A CR       | 1                |



**RUKOHVAT**  
*cm 37 x 17H x 5 (~150 kg)*

| Šifra<br>VOKEL | Boja | Broj<br>Artikla | Pakovanje<br>KOM |
|----------------|------|-----------------|------------------|
| 0468199        | KROM | A33920 CR       | 1                |



**DOZATOR ZA TEKUĆI SAPUN  
SA DRŽAČEM**  
*cm 9 x 16H x 13*

| Šifra<br>VOKEL | Opis    | Boja | Broj<br>Artikla | Pakovanje<br>KOM |
|----------------|---------|------|-----------------|------------------|
| 0468194        | KOMPLET | KROM | A33120 CR 21    | 1                |
| 0468059        | DOZATOR | -    | A4667A          | 1                |



**DRŽAČ ČAŠE SA ČAŠOM**  
*cm 8 x 11H x 12*

| Šifra<br>VOKEL | Opis    | Boja | Broj<br>Artikla | Pakovanje<br>KOM |
|----------------|---------|------|-----------------|------------------|
| 0468195        | KOMPLET | KROM | A33100 CR 21    | 1                |
| 0468061        | ČAŠA    | -    | R46100          | 1                |



**DRŽAČ SAPUNA SA SAPUNJAROM**  
*cm 13 x 5H x 15*

| Šifra<br>VOKEL | Opis         | Boja      | Broj<br>Artikla | Pakovanje<br>KOM |
|----------------|--------------|-----------|-----------------|------------------|
| 0468196        | KOMPLET KROM | A33110 CR | 21              | 1                |
| 0468062        | SAPUNICA     | -         | R46110          | 1                |



**VJEŠALICA 2/1**  
*cm 10 x 4H x 4*

| Šifra<br>VOKEL | Boja | Broj<br>Artikla | Pakovanje<br>KOM |
|----------------|------|-----------------|------------------|
| 0468193        | KROM | A33200 CR       | 1                |



**DRŽAČ TOALET PAPIRA**  
*cm 19 x 4H x 8*

| Šifra<br>VOKEL | Boja | Broj<br>Artikla | Pakovanje<br>KOM |
|----------------|------|-----------------|------------------|
| 0468200        | KROM | A3325A CR       | 1                |



**WC ČETKA ZIDNA**  
*cm 9 x 40H x 12*

| Šifra<br>VOKEL | Boja | Broj<br>Artikla | Pakovanje<br>KOM |
|----------------|------|-----------------|------------------|
| 0468201        | KROM | A33140 CR       | 1                |

## DRŽAČ ZA ČAŠU ESSENTIALS CUBE

| Šifra<br>VOKEL | Boja | Broj<br>Artikla | Pakovanje<br>KOM |
|----------------|------|-----------------|------------------|
| 1154001        | KROM | 40508000        | 1                |

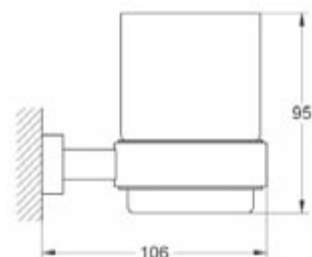

## STAKLENA ČAŠA ZA ESSENTIALS ILI ESSENTIALS CUBE

| Šifra<br>VOKEL | Boja | Broj<br>Artikla | Pakovanje<br>KOM |
|----------------|------|-----------------|------------------|
| 1154002        | -    | 40372000        | 1                |

## DRŽAČ POSUDE ZA SAPUN ESSENTIALS CUBE

| Šifra<br>VOKEL | Boja | Broj<br>Artikla | Pakovanje<br>KOM |
|----------------|------|-----------------|------------------|
| 1154001        | KROM | 40508000        | 1                |

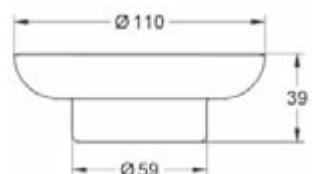

## STAKLENA POSUDA ZA SAPUN ZA ESSENTIALS ILI ESSENTIALS CUBE

| Šifra<br>VOKEL | Boja | Broj<br>Artikla | Pakovanje<br>KOM |
|----------------|------|-----------------|------------------|
| 1154003        | -    | 40368000        | 1                |

## DRŽAČ DOZATORA ZA TEKUĆI SAPUN ESSENTIALS CUBE

| Šifra<br>VOKEL | Boja | Broj<br>Artikla | Pakovanje<br>KOM |
|----------------|------|-----------------|------------------|
| 1154001        | KROM | 40508000        | 1                |

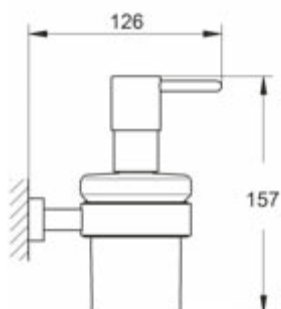

## DOZATOR ZA TEKUĆI SAPUN ZA ESSENTIALS ILI ESSENTIALS CUBE

| Šifra<br>VOKEL | Boja | Broj<br>Artikla | Pakovanje<br>KOM |
|----------------|------|-----------------|------------------|
| 1154004        | KROM | 40394000        | 1                |

## WC ČETKA S DRŽAČEM ESSENTIALS CUBE

| Šifra<br>VOKEL | Boja | Broj<br>Artikla | Pakovanje<br>KOM |
|----------------|------|-----------------|------------------|
| 1154005        | KROM | 40513000        | 1                |

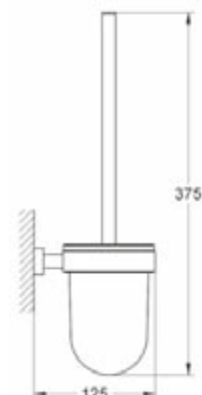



## DRŽAČ TOALET PAPIRA ESSENTIALS CUBE

| Šifra<br>VOKEL | Boja | Broj<br>Artikla | Pakovanje<br>KOM |
|----------------|------|-----------------|------------------|
| 1154006        | KROM | 40507000        | 1                |

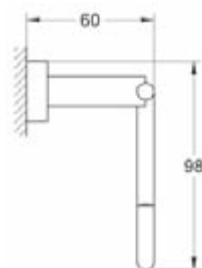

## DRŽAČ RUČNIKA ESSENTIALS CUBE

| Šifra<br>VOKEL | Boja | Broj<br>Artikla | Pakovanje<br>KOM |
|----------------|------|-----------------|------------------|
| 1154008        | KROM | 40510000        | 1                |

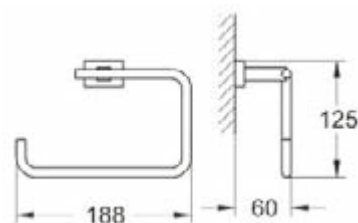

## RUKOHVAT 39 cm ESSENTIALS CUBE

| Šifra<br>VOKEL | Boja | Broj<br>Artikla | Pakovanje<br>KOM |
|----------------|------|-----------------|------------------|
| 1154007        | KROM | 40514000        | 1                |



## DRŽAČ RUČNIKA 60 cm ESSENTIALS CUBE

| Šifra<br>VOKEL | Boja | Broj<br>Artikla | Pakovanje<br>KOM |
|----------------|------|-----------------|------------------|
| 1154009        | KROM | 40509000        | 1                |



## VJEŠALICA ESSENTIALS CUBE

| Šifra<br>VOKEL | Boja | Broj<br>Artikla | Pakovanje<br>KOM |
|----------------|------|-----------------|------------------|
| 1154010        | KROM | 40511000        | 1                |

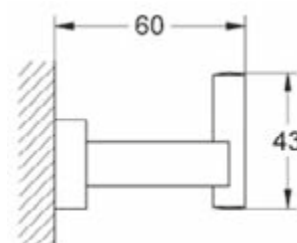

## DRŽAČ ZA ČAŠU ESSENTIALS

| Šifra<br>VOKEL | Boja | Broj<br>Artikla | Pakovanje<br>KOM |
|----------------|------|-----------------|------------------|
| 1155001        | KROM | 40369000        | 1                |

## STAKLENA ČAŠA ZA ESSENTIALS ILI ESSENTIALS CUBE

| Šifra<br>VOKEL | Boja | Broj<br>Artikla | Pakovanje<br>KOM |
|----------------|------|-----------------|------------------|
| 1154002        | -    | 40372000        | 1                |

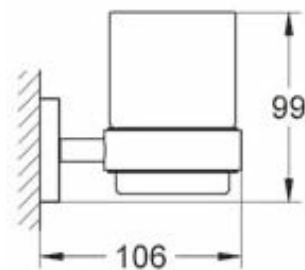

## DRŽAČ POSUDE ZA SAPUN ESSENTIALS

| Šifra<br>VOKEL | Boja | Broj<br>Artikla | Pakovanje<br>KOM |
|----------------|------|-----------------|------------------|
| 1155001        | KROM | 40369000        | 1                |

## STAKLENA POSUDA ZA SAPUN ZA ESSENTIALS ILI ESSENTIALS CUBE

| Šifra<br>VOKEL | Boja | Broj<br>Artikla | Pakovanje<br>KOM |
|----------------|------|-----------------|------------------|
| 1154003        | -    | 40368000        | 1                |

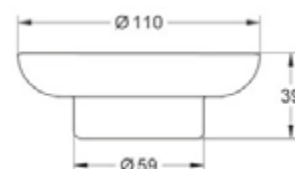

## DRŽAČ DOZATORA ZA TEKUĆI SAPUN ESSENTIALS

| Šifra<br>VOKEL | Boja | Broj<br>Artikla | Pakovanje<br>KOM |
|----------------|------|-----------------|------------------|
| 1155001        | KROM | 40369000        | 1                |

## DOZATOR ZA TEKUĆI SAPUN ZA ESSENTIALS ILI ESSENTIALS CUBE

| Šifra<br>VOKEL | Boja | Broj<br>Artikla | Pakovanje<br>KOM |
|----------------|------|-----------------|------------------|
| 1154004        | KROM | 40394000        | 1                |

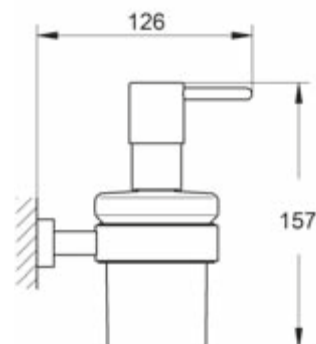

## WC ČETKA S DRŽAČEM ESSENTIALS

| Šifra<br>VOKEL | Boja | Broj<br>Artikla | Pakovanje<br>KOM |
|----------------|------|-----------------|------------------|
| 1155007        | KROM | 40374000        | 1                |

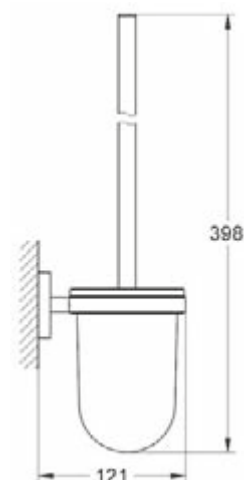

## DRŽAČ TOALETNOG PAPIRA ESSENTIALS

| Šifra<br>VOKEL | Boja | Broj<br>Artikla | Pakovanje<br>KOM |
|----------------|------|-----------------|------------------|
| 1155006        | KROM | 40367000        | 1                |

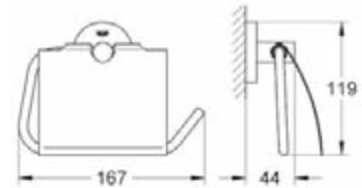

## DRŽAČ TOALETNOG PAPIRA VERTIKALNI ESSENTIALS

| Šifra<br>VOKEL | Boja | Broj<br>Artikla | Pakovanje<br>KOM |
|----------------|------|-----------------|------------------|
| 1155008        | KROM | 40385000        | 1                |

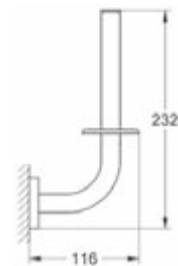

## DRŽAČ RUČNIKA OKRUGLI ESSENTIALS

| Šifra<br>VOKEL | Boja | Broj<br>Artikla | Pakovanje<br>KOM |
|----------------|------|-----------------|------------------|
| 1155002        | KROM | 40365000        | 1                |

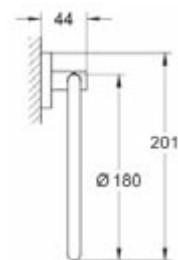

## DRŽAČ RUČNIKA 2/1 POKRETNI ESSENTIALS

| Šifra<br>VOKEL | Boja | Broj<br>Artikla | Pakovanje<br>KOM |
|----------------|------|-----------------|------------------|
| 1155003        | KROM | 40371000        | 1                |



## DRŽAČ RUČNIKA 60 cm FIKSNI ESSENTIALS



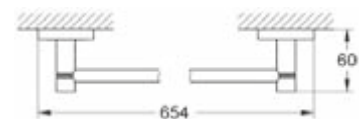





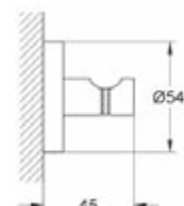





| Šifra<br>VOKEL | Boja | Broj<br>Artikla | Pakovanje<br>KOM |
|----------------|------|-----------------|------------------|
| 1155004        | KROM | 40366000        | 1                |



## VJEŠALICA ESSENTIALS

| Šifra<br>VOKEL | Boja | Broj<br>Artikla | Pakovanje<br>KOM |
|----------------|------|-----------------|------------------|
| 1155005        | KROM | 40364000        | 1                |



|                                                                                     |                |                                            |               |
|-------------------------------------------------------------------------------------|----------------|--------------------------------------------|---------------|
|    | <b>1151001</b> | DRŽAČ SAPUNA SA SAPUNICOM                  | ART.71602     |
|                                                                                     | <b>1151042</b> | STAKLENA SAPUNICA                          | ART.915       |
|    | <b>1151002</b> | DRŽAČ ČAŠE SA ČAŠOM                        | ART.71601     |
|                                                                                     | <b>1151043</b> | STAKLENA ČAŠA                              | ART.905       |
|    | <b>1151003</b> | DRŽAČ POLICE SA POLICOM 45 cm              | ART.71605     |
|    | <b>1151041</b> | DRŽAČ RUČNIKA FIKSNI 30 cm                 | ART.71608-12" |
|                                                                                     | <b>1151004</b> | DRŽAČ RUČNIKA FIKSNI 46 cm                 | ART.71608-18" |
|                                                                                     | <b>1151005</b> | DRŽAČ RUČNIKA FIKSNI 61 cm                 | ART.71608-24" |
|    | <b>1151006</b> | DRŽAČ RUČNIKA DUPLI FIKSNI 46 cm           | ART.71613-18" |
|                                                                                     | <b>1151007</b> | DRŽAČ RUČNIKA DUPLI FIKSNI 61 cm           | ART.71613-24" |
|    | <b>1151045</b> | DRŽAČ RUČNIKA POKRETNI 2/1 47 cm           | ART.71614     |
|   | <b>1151057</b> | DRŽAČ RUČNIKA 53 cm 530x230x115 mm         | ART.71611     |
|                                                                                     | <b>1151058</b> | DRŽAČ RUČNIKA 67 cm 670x230x115 mm         | ART.71612     |
|  | <b>1151009</b> | DRŽAČ TOALET PAPIRA                        | ART.71603     |
|  | <b>1151061</b> | DRŽAČ KUHINJSKOG UBRUSA 28 cm 280x88x50 mm | ART.71628     |
|  | <b>1151010</b> | DRŽAČ REZERVNOG TOALET PAPIRA              | ART.71617     |
|  | <b>1151011</b> | DRŽAČ RUČNIKA OKRUGLI                      | ART.71604     |
|  | <b>1151012</b> | VJEŠALICA                                  | ART.71606     |
|  | <b>1151013</b> | VJEŠALICA 2/1                              | ART.71616     |
|  | <b>1151014</b> | DRŽAČ WC ČETKE SA ČETKOM                   | ART.71615     |

|                                                                                     |                |                                          |            |
|-------------------------------------------------------------------------------------|----------------|------------------------------------------|------------|
|    | <b>1151015</b> | DRŽAČ SAPUNA SA SAPUNICOM                | ART.85202  |
|    | <b>1151016</b> | DRŽAČ ČAŠE SA ČAŠOM                      | ART.85201  |
|    | <b>1151017</b> | DRŽAČ POLICE SA POLICOM 50 cm            | ART.85205  |
|    | <b>1151018</b> | DRŽAČ RUČNIKA FIKSNI 60 cm               | ART.85208  |
|    | <b>1151019</b> | DRŽAČ RUČNIKA DUPLI FIKSNI 60 cm         | ART.85213  |
|   | <b>1151020</b> | DRŽAČ TOALET PAPIRA                      | ART.85203  |
|  | <b>1151044</b> | DRŽAČ TOALET PAPIRA                      | ART.85207  |
|  | <b>1151053</b> | DRŽAČ TOALET PAPIRA DUPLI 170x120x210 mm | ART.85218  |
|  | <b>1151021</b> | DRŽAČ RUČNIKA OKRUGLI                    | ART.85204  |
|  | <b>1151054</b> | KUTIJA ZA PAPIR 250x130x70 mm            | ART.85217  |
|  | <b>1151022</b> | VJEŠALICA                                | ART.85206  |
|  | <b>1151024</b> | WC ČETKA                                 | ART.711610 |



|                                                                                     |                |                                              |             |
|-------------------------------------------------------------------------------------|----------------|----------------------------------------------|-------------|
|    | <b>1151050</b> | ETAŽER KUTNI REŠETKASTI DUPLI 257x189x265 mm | ART.56210N  |
|   | <b>1151051</b> | ETAŽER KUTNI REŠETKASTI DUPLI 235x160x350 mm | ART.56220N  |
|  | <b>1151046</b> | ETAŽER REŠETKASTI 135x90x45 mm               | ART.56112N  |
|  | <b>1151047</b> | ETAŽER REŠETKASTI 180x90x35 mm               | ART.56114N  |
|  | <b>1151048</b> | ETAŽER REŠETKASTI 130x100x30 mm              | ART.56119N  |
|  | <b>1151049</b> | ETAŽER REŠETKASTI 165x130x30 mm              | ART.56115N  |
|  | <b>1151052</b> | DRŽAČ FENA                                   | ART.607710N |

|  |         |                                                               |                |
|--|---------|---------------------------------------------------------------|----------------|
|  | 1151032 | KANTA ZA SMEĆE 3 litara                                       | ART.639103-3L  |
|  | 1151033 | KANTA ZA SMEĆE 5 litara                                       | ART.639105-5L  |
|  | 1151034 | KANTA ZA SMEĆE 7 litara                                       | ART.639107-7L  |
|  | 1151035 | KANTA ZA SMEĆE 12 litara                                      | ART.639112-12L |
|  | 1151059 | KANTICA ZA SMEĆE 9 L 205x270 mm                               | ART.65801-9L   |
|  | 1151056 | DOZATOR ZA TEKUĆI SAPUN 400 ml                                | ART.66400      |
|  | 1151036 | KUPAONSKA OZNAKA ZA WC 60x60x1 mm                             | ART.207581     |
|  | 1151037 | KUPAONSKA OZNAKA ZA WC MUŠKI 60x60x1 mm                       | ART.207281     |
|  | 1151038 | KUPAONSKA OZNAKA ZA WC ŽENSKI 60x60x1 mm                      | ART.207181     |
|  | 1151039 | KUPAONSKA OZNAKA ZA WC OSOBE SA POSEBNIM POTREBAMA 60x60x1 mm | ART.207081     |



|  |                |                                      |
|--|----------------|--------------------------------------|
|  | <p>1384001</p> | <p>LJEPILO TRITON FIX V6 AEROSOL</p> |
|--|----------------|--------------------------------------|

## PRIPREMA ZA LJEPLJENJE

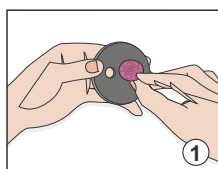

1. Očistiti površinu namijenjenu za ljepljenje proizvoda od prašine, masnoće i ostalih nečistoća s spužvicom.

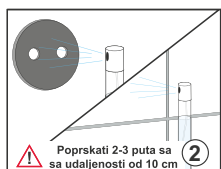

2. Poprskati površinu namijenjenu za ljepljenje s raspršivačem 2-3 puta.

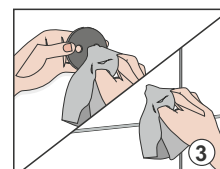

3. Površinu namijenjenu za ljepljenje posušiti suhom krpom.

## UPUTSTVO ZA MONTAŽU

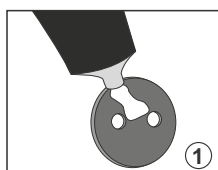

1. Nanijeti sloj ljepila na područje podloške za ljepljenje. Neiskorišteno ljepilo ostaviti zatvoreno u tubi za ponovnu upotrebu.

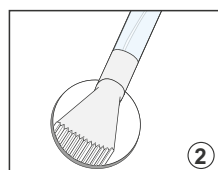

2. Ljepilo ravnomjerno rasporediti lopaticom po cijeloj površini podloške za ljepljenje.

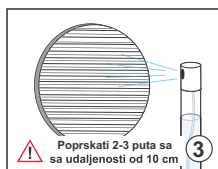

3. Poprskati 2-3 puta raspršivačem s udaljenosti oko 10 cm po području s nanesenim ljepilom.

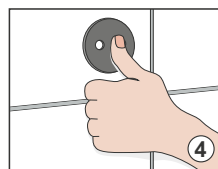

4. Postaviti podlošku s nanesenim ljepilom na zid i pritisnuti podlošku.

Ljepilo postiže svoju 100%-tnu učinkovitost nakon 72 sata.

## UKLANJANJE LJEPILO

Ljepilo se može ukloniti bez ostavljanja tragova koristeći kombinirke, špatle, skalpel.

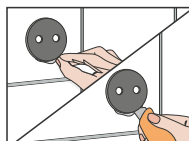













## PODRUČJA PRIMJENE GLABETE AERSOL LJEPILO



Ljepilo se može koristiti za ljepljenje glatkih površina u domaćinstvu, industriji i sl.

|                                                                                     |         |                                           |               |
|-------------------------------------------------------------------------------------|---------|-------------------------------------------|---------------|
|    | 1160025 | SAMOSTOJEĆI DRŽAČ ČAŠE S ČAŠOM OMEGA      | ART.138110061 |
|    | 1160055 | DRŽAČ ČAŠE S ČAŠOM OMEGA                  | ATR.104110012 |
|    | 1160026 | SAMOSTOJEĆI DOZATOR SAPUNA OMEGA          | ART.138109161 |
|    | 1160023 | DOZATOR SAPUNA OMEGA                      | ART.104109017 |
|   | 1160057 | DOZATOR SAPUNA 200 ml OMEGA               | ART.104109102 |
|  | 1160056 | DRŽAČ SAPUNA SA STAKLENOM SAPUNICOM OMEGA | ART.104108042 |
|  | 1160054 | DRŽAČ SAPUNA OMEGA                        | ART.104208082 |
|  | 1160021 | VJEŠALICA OMEGA                           | ART.104105252 |
|  | 1160022 | VJEŠALICA 3/1 OMEGA                       | ART.104405232 |
|  | 1160049 | VJEŠALICA OMEGA                           | ART.104106022 |
|  | 1160050 | VJEŠALICA OMEGA                           | ART.104206022 |
|  | 1160051 | DUPLA VJEŠALICA OMEGA                     | ART.104106032 |

|                                                                                     |                |                                       |               |
|-------------------------------------------------------------------------------------|----------------|---------------------------------------|---------------|
|    | <b>1160052</b> | VJEŠALICA OMEGA                       | ART.104506092 |
|    | <b>1160053</b> | TROSTRUKA OKRETNNA VJEŠALICA OMEGA    | ART.104206072 |
|    | <b>1160058</b> | VJEŠALICA S ČETIRI KUKKE OMEGA        | ART.104606102 |
|    | <b>1160059</b> | OKRETNNI DRŽAČ RUČNIKA OMEGA          | ART.104204102 |
|    | <b>1160060</b> | DRŽAČ RUČNIKA 355 mm OMEGA            | ART.104204012 |
|   | <b>1160061</b> | DRŽAČ RUČNIKA 505mm OMEGA             | ART.104204022 |
|  | <b>1160062</b> | DRŽAČ RUČNIKA 655mm OMEGA             | ART.104204042 |
|  | <b>1160063</b> | DUPLI DRŽAČ RUČNIKA 655mm OMEGA       | ART.104204052 |
|  | <b>1160064</b> | POLICA ZA RUČNIKE 655x110x215mm OMEGA | ART.104205072 |
|  | <b>1160065</b> | POLICA ZA RUČNIKE 655x160x225mm OMEGA | ART.104205102 |
|  | <b>1160066</b> | DRŽAČ WC PAPIRA S POKLOPCEM OMEGA     | ART.104112012 |
|  | <b>1160067</b> | DRŽAČ WC PAPIRA OMEGA                 | ART.104112042 |
|  | <b>1160068</b> | DRŽAČ WC PAPIRA OMEGA                 | ART.104212032 |



|                                                                                    |                       |                                                          |
|------------------------------------------------------------------------------------|-----------------------|----------------------------------------------------------|
|   | <p><b>1160069</b></p> | <p>DRŽAČ REZERVNOG WC PAPIRA OMEGA ART.104112032</p>     |
|   | <p><b>1160070</b></p> | <p>DUPLI DRŽAČ WC PAPIRA OMEGA ART.104201072</p>         |
|   | <p><b>1160024</b></p> | <p>WC ČETKA OMEGA ART.102313066</p>                      |
|  | <p><b>1160071</b></p> | <p>WC ČETKA SA STAKLENOM POSUDOM OMEGA ART.104113012</p> |

|                                                                                     |                |                                       |               |
|-------------------------------------------------------------------------------------|----------------|---------------------------------------|---------------|
|    | <b>1160002</b> | DRŽAČ SAPUNA SA SAPUNICOM PLAZA       | ART.118108022 |
|    | <b>1160027</b> | SAMOSTOJEĆI DRŽAČ ČAŠE S ČAŠOM PLAZA  | ART.140110061 |
|    | <b>1160001</b> | DRŽAČ ČAŠE S ČAŠOM PLAZA              | ART.118210019 |
|    | <b>1160028</b> | SAMOSTOJEĆI DOZATOR SAPUNA PLAZA      | ART.140109161 |
|    | <b>1160048</b> | DOZATOR SAPUNA PLAZA                  | ART.118109042 |
|   | <b>1160003</b> | DOZATOR SAPUNA PLAZA                  | ART.118209049 |
|  | <b>1160004</b> | DRŽAČ RUČNIKA PLAZA                   | ART.118104062 |
|  | <b>1160006</b> | DRŽAČ RUČNIKA 625 mm PLAZA            | ART.118104042 |
|  | <b>1160007</b> | DRŽAČ RUČNIKA VIŠECJEVNI 585 mm PLAZA | ART.118104122 |
|  | <b>1160008</b> | DRŽAČ TOALET PAPIRA PLAZA             | ART.118112022 |
|  | <b>1160010</b> | DRŽAČ TOALET PAPIRA S POKLOPCEM PLAZA | ART.118112012 |
|  | <b>1160005</b> | VJEŠALICA 2/1 PLAZA                   | ART.118106032 |
|  | <b>1160009</b> | WC ČETKA S NOSAČEM ZA ZID PLAZA       | ART.118213092 |



|                                                                                     |                |                                                        |
|-------------------------------------------------------------------------------------|----------------|--------------------------------------------------------|
|    | <b>1160014</b> | DRŽAČ SAPUNA SA SAPUNICOM BRONZE RETRO 3 ART.144108027 |
|    | <b>1160015</b> | DRŽAČ ČAŠE S ČAŠOM BRONZE RETRO 3 ART.144110017        |
|    | <b>1160013</b> | DOZATOR SAPUNA BRONZE RETRO 3 ART.144109107            |
|    | <b>1160017</b> | DRŽAČ SAPUNA REŠETKASTI BRONZE RETRO 3 ART.144108167   |
|   | <b>1160019</b> | DRŽAČ RUČNIKA OKRUGLI BRONZE RETRO 3 ART.144104067     |
|  | <b>1160016</b> | DRŽAČ RUČNIKA 365 mm BRONZE RETRO 3 ART.144104017      |
|  | <b>1160020</b> | DRŽAČ TOALET PAPIRA BRONZE RETRO 3 ART.144112027       |
|  | <b>1160011</b> | VJEŠALICA BRONZE RETRO 3 ART.144106017                 |
|  | <b>1160012</b> | VJEŠALICA 2/1 BRONZE RETRO 3 ART.144113017             |
|  | <b>1160018</b> | WC ČETKA BRONZE RETRO 3 ART.118213092                  |

|                                                                                     |                |                                              |               |
|-------------------------------------------------------------------------------------|----------------|----------------------------------------------|---------------|
|    | <b>1160076</b> | DRŽAČ ČAŠE S ČAŠOM INOX NEO                  | ART.104110015 |
|    | <b>1160075</b> | DOZATOR SAPUNA 200ml INOX NEO                | ART.104109115 |
|    | <b>1160077</b> | DRŽAČ SAPUNA SA STAKLENOM SAPUNICOM INOX NEO | ART.104108045 |
|    | <b>1160078</b> | DRŽAČ SAPUNA INOX NEO                        | ART.104208085 |
|   | <b>1160079</b> | POLICA ZA SAPUN INOX NEO                     | ART.146102275 |
|  | <b>1160081</b> | VJEŠALICA INOX NEO                           | ART.104106025 |
|  | <b>1160082</b> | DUPLA VJEŠALICA INOX NEO                     | ART.104106035 |
|  | <b>1160083</b> | VJEŠALICA INOX NEO                           | ART.104506095 |
|  | <b>1160084</b> | RUKOHVAT 355 mm INOX NEO                     | ART.102307015 |
|  | <b>1160085</b> | DRŽAČ RUČNIKA 355 mm INOX NEO                | ART.104204015 |
|  | <b>1160086</b> | DRŽAČ RUČNIKA 505 mm INOX NEO                | ART.104204125 |
|  | <b>1160087</b> | DRŽAČ RUČNIKA 655 mm INOX NEO                | ART.104204045 |





|                                                                                     |         |                                       |               |
|-------------------------------------------------------------------------------------|---------|---------------------------------------|---------------|
|    | 1160080 | KUTIJA ZA HIGIJENSKE VREĆICE INOX NEO | ART.101403035 |
|    | 1160088 | DRŽAČ WC PAPIRA INOX NEO              | ART.104112045 |
|    | 1160089 | DRŽAČ WC PAPIRA S POKOPCEM INOX NEO   | ART.104112015 |
|    | 1160090 | DRŽAČ WC PAPIRA INOX NEO              | ART.104212035 |
|   | 1160091 | REZERVNI DRŽAČ WC PAPIRA INOX NEO     | ART.104112035 |
|  | 1160092 | WC ČETKA INOX NEO                     | ART.102313069 |

|                                                                                     |         |                               |               |
|-------------------------------------------------------------------------------------|---------|-------------------------------|---------------|
|  | 1160093 | STALAK S DRŽAČEM RUČNIKA BETA | ART.132836022 |
|-------------------------------------------------------------------------------------|---------|-------------------------------|---------------|



|                                                                                   |                |                                                      |               |
|-----------------------------------------------------------------------------------|----------------|------------------------------------------------------|---------------|
|  | <b>1160072</b> | ETAŽER KUTNI REŠETKASTI 170x30x100 mm<br>CYTRO       | ART.106308172 |
|  | <b>1160073</b> | DUPLI ETAŽER KUTNI REŠETKASTI<br>245x60x150 mm CYTRO | ART.102308132 |
|  | <b>1160074</b> | ETAŽER REŠETKASTI 230x30x100 mm CYTRO                | ART.102308072 |





### KOZMETIČKA OGLEDALA

|                                                                                     |                |                                      |               |
|-------------------------------------------------------------------------------------|----------------|--------------------------------------|---------------|
|  | <b>1160029</b> | ZIDNO KOZMETIČKO OGLEDALO            | ART.112201152 |
|  | <b>1160030</b> | ZIDNO KOZMETIČKO OGLEDALO            | ART.106301122 |
|  | <b>1160031</b> | ZIDNO KOZMETIČKO OGLEDALO            | ART.112201172 |
|  | <b>1160032</b> | ZIDNO KOZMETIČKO OGLEDALO ČETVRTASTO | ART.112201192 |

|                                                                                     |                |                                                                  |               |
|-------------------------------------------------------------------------------------|----------------|------------------------------------------------------------------|---------------|
|    | <b>1160033</b> | KUTIJA ZA HIGIJENSKE VREĆICE OD KROMIRANE PLASTIKE 100x140x25 mm | ART.101403032 |
|    | <b>1160038</b> | KUTIJA ZA HIGIJENSKE VREĆICE INOX 100x140x25 mm                  | ART.101403031 |
|    | <b>1160047</b> | DRŽAČ HIGIJENSKIH VREĆICA                                        | ART.101403091 |
|    | <b>1160037</b> | PODŽBUKNA KUTIJA ZA PAPIRNATE UBRUSE                             | ART.113103021 |
|  | <b>1160039</b> | PODŽBUKNA KUTIJA ZA PAPIRNATE UBRUSE                             | ART.134203022 |
|  | <b>1160040</b> | PODŽBUKNI DRŽAČ WC PAPIRA                                        | ART.134103012 |
|  | <b>1160034</b> | PODPULTNI DOZATOR SAPUNA 310 ml                                  | ART.136109011 |
|  | <b>1160035</b> | ZIDNA KANTA ZA SMEĆE 6 Litara                                    | ART.101915051 |
|  | <b>1160036</b> | KANTA ZA SMEĆE S PEPELJAROM                                      | ART.106315032 |



|                                                                                    |                |                                       |               |
|------------------------------------------------------------------------------------|----------------|---------------------------------------|---------------|
|   | <b>1160044</b> | RUKOHVAT RAVNI 335 mm                 | ART.106107011 |
|   | <b>1160045</b> | RUKOHVAT ZAKRIVLJENI                  | ART.106107021 |
|  | <b>1160046</b> | RUKOHVAT ZAKRIVLJENI S DRŽAČEM SAPUNA | ART.106107031 |

|                                                                                     |                                                                                                               |                                                                                                                                                                                                         |                                                                                                          |
|-------------------------------------------------------------------------------------|---------------------------------------------------------------------------------------------------------------|---------------------------------------------------------------------------------------------------------------------------------------------------------------------------------------------------------|----------------------------------------------------------------------------------------------------------|
|    | <p><b>1161001</b></p> <p><b>1161002</b></p> <p><b>1161003</b></p> <p><b>1161004</b></p> <p><b>1161005</b></p> | <p>RUKOHVAT RAVNI HELP 40 cm BIJELI</p> <p>RUKOHVAT RAVNI HELP 50 cm BIJELI</p> <p>RUKOHVAT RAVNI HELP 60 cm BIJELI</p> <p>RUKOHVAT RAVNI HELP 70 cm BIJELI</p> <p>RUKOHVAT RAVNI HELP 80 cm BIJELI</p> | <p>ART.301100404</p> <p>ART.301100504</p> <p>ART.301100604</p> <p>ART.301100704</p> <p>ART.301100804</p> |
|    | <p><b>1161006</b></p>                                                                                         | <p>OSLONAC U-OBLIK HELP 813 mm BIJELI</p>                                                                                                                                                               | <p>ART.301102064</p>                                                                                     |
|   | <p><b>1161007</b></p>                                                                                         | <p>OSLONAC U-OBLIK NA SKLAPANJE<br/>HELP 813 mm BIJELI</p>                                                                                                                                              | <p>ART.301102084</p>                                                                                     |
|  | <p><b>1161008</b></p>                                                                                         | <p>OSLONAC U-OBLIK NA SKLAPANJE S DRŽAČEM WC<br/>PAPIRA HELP 813 mm BIJELI</p>                                                                                                                          | <p>ART.301102284</p>                                                                                     |
|  | <p><b>1161009</b></p>                                                                                         | <p>RUKOHVAT KUTNI 120° HELP BIJELI</p>                                                                                                                                                                  | <p>ART.301102014</p>                                                                                     |
|  | <p><b>1161012</b></p>                                                                                         | <p>RUKOHVAT ZA TUŠ HELP BIJELI</p>                                                                                                                                                                      | <p>ART.301102034</p>                                                                                     |

|                                                                                     |                       |                                                                          |
|-------------------------------------------------------------------------------------|-----------------------|--------------------------------------------------------------------------|
|    | <p><b>1161010</b></p> | <p>RUKOHVAT ZA TUŠ S KONZOLOM KUTNI DESNI HELP BIJELI ART.301122024</p>  |
|    | <p><b>1161011</b></p> | <p>RUKOHVAT ZA TUŠ S KONZOLOM KUTNI LIJEVI HELP BIJELI ART.301112024</p> |
|  | <p><b>1161013</b></p> | <p>RUKOHVAT ZA TUŠ S KONZOLOM DESNI HELP BIJELI ART.301122044</p>        |
|  | <p><b>1161014</b></p> | <p>RUKOHVAT ZA TUŠ S KONZOLOM LIJEVI HELP BIJELI ART.301112044</p>       |
|  | <p><b>1161021</b></p> | <p>DRŽAČ TUŠ RUČICE HELP ZA RUKOHVATE S TUŠ KONZOLOM ART.338514372</p>   |

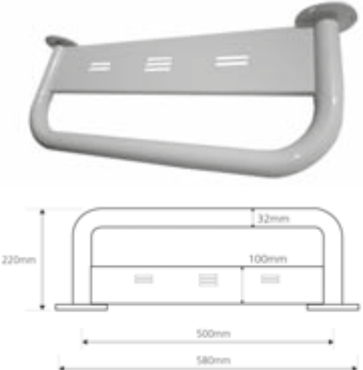

|                                                                                     |                       |                                                                |                      |
|-------------------------------------------------------------------------------------|-----------------------|----------------------------------------------------------------|----------------------|
|    | <p><b>1161015</b></p> | <p>POTPORNI OSOLONAC U-OBLIK DESNI HELP<br/>813 mm BIJELI</p>  | <p>ART.301112164</p> |
|    | <p><b>1161016</b></p> | <p>POTPORNI OSOLONAC U-OBLIK LIJEVI HELP<br/>813 mm BIJELI</p> | <p>ART.301112154</p> |
|  | <p><b>1161017</b></p> | <p>SJEDALICA NA SKLAPANJE HELP</p>                             | <p>ART.326325056</p> |
|  | <p><b>1161018</b></p> | <p>SJEDALICA NA SKLAPANJE S POTPOROM HELP</p>                  | <p>ART.301102181</p> |
|  | <p><b>1161019</b></p> | <p>SJEDALICA ZA KADU HELP</p>                                  | <p>ART.338125066</p> |

|                                                                                     |                                             |                                                                                                         |                                           |
|-------------------------------------------------------------------------------------|---------------------------------------------|---------------------------------------------------------------------------------------------------------|-------------------------------------------|
|    | <p><b>1161020</b></p>                       | <p>TUŠ SJEDALICA VISEĆA ZA RUKOHVAT<br/>HELP</p>                                                        | <p>ART.338125081</p>                      |
|   | <p><b>1161022</b></p>                       | <p>POLICA S DRŽAČEM 500x230 mm<br/>HELP BIJELO</p>                                                      | <p>ART.301100574</p>                      |
|  | <p><b>1161023</b></p> <p><b>1161024</b></p> | <p>POKRETNO OGLEDALO 400x600 mm<br/>HELP BIJELO</p> <p>POKRETNO OGLEDALO 600x600 mm<br/>HELP BIJELO</p> | <p>ART.301401034</p> <p>ART.301401044</p> |



**VJEŠALICA**

| Šifra<br>VOKEL | Boja | Broj<br>Artikla | Pakovanje<br>KOM |
|----------------|------|-----------------|------------------|
| 86039          | KROM | 22010           | 1                |



**DRŽAČ RUČNIKA FIKSNI  
60 cm**

| Šifra<br>VOKEL | Boja | Broj<br>Artikla | Pakovanje<br>KOM |
|----------------|------|-----------------|------------------|
| 86042          | KROM | 22013           | 1                |



**DRŽAČ RUČNIKA**

| Šifra<br>VOKEL | Boja | Broj<br>Artikla | Pakovanje<br>KOM |
|----------------|------|-----------------|------------------|
| 86041          | KROM | 22012           | 1                |



**DRŽAČ RUČNIKA DUPLI  
FIKSNI 60 cm**

| Šifra<br>VOKEL | Boja | Broj<br>Artikla | Pakovanje<br>KOM |
|----------------|------|-----------------|------------------|
| 86045          | KROM | 22019           | 1                |



**DRŽAČ RUČNIKA  
POKRETNI 2/1**

| Šifra<br>VOKEL | Boja | Broj<br>Artikla | Pakovanje<br>KOM |
|----------------|------|-----------------|------------------|
| 86065          | KROM | 22021           | 1                |



**DRŽAČ RUČNIKA**

| Šifra<br>VOKEL | Boja | Broj<br>Artikla | Pakovanje<br>KOM |
|----------------|------|-----------------|------------------|
| 0491068        | KROM | 22022           | 1                |



**DRŽAČ SAPUNA SA STAKLENOM  
SAPUNJAROM**

| Šifra<br>VOKEL | Boja | Broj<br>Artikla | Pakovanje<br>KOM |
|----------------|------|-----------------|------------------|
| 86044          | KROM | 22015           | 1                |



**DRŽAČ TOALET  
PAPIRA**

| Šifra<br>VOKEL | Boja | Broj<br>Artikla | Pakovanje<br>KOM |
|----------------|------|-----------------|------------------|
| 86040          | KROM | 22011           | 1                |



**WC ČETKA**

| Šifra<br>VOKEL | Boja | Broj<br>Artikla | Pakovanje<br>KOM |
|----------------|------|-----------------|------------------|
| 86046          | KROM | 22020           | 1                |



**DRŽAČ ČAŠE SA ČAŠOM**

| Šifra<br>VOKEL | Boja | Broj<br>Artikla | Pakovanje<br>KOM |
|----------------|------|-----------------|------------------|
| 86043          | KROM | 22014           | 1                |



**VJEŠALICA**

| Šifra<br>VOKEL | Boja | Broj<br>Artikla | Pakovanje<br>KOM |
|----------------|------|-----------------|------------------|
| 0491069        | KROM | 62010           | 1                |



**DRŽAČ RUČNIKA FIKSNI  
40 cm**

| Šifra<br>VOKEL | Boja | Broj<br>Artikla | Pakovanje<br>KOM |
|----------------|------|-----------------|------------------|
| 0491073        | KROM | 62024           | 1                |



**DRŽAČ RUČNIKA FIKSNI  
60 cm**

| Šifra<br>VOKEL | Boja | Broj<br>Artikla | Pakovanje<br>KOM |
|----------------|------|-----------------|------------------|
| 0491072        | KROM | 62013           | 1                |



**DRŽAČ RUČNIKA  
POKRETNI 2/1**

| Šifra<br>VOKEL | Boja | Broj<br>Artikla | Pakovanje<br>KOM |
|----------------|------|-----------------|------------------|
| 0491074        | KROM | 62021           | 1                |



**DRŽAČ RUČNIKA  
OKRUGLI**

| Šifra<br>VOKEL | Boja | Broj<br>Artikla | Pakovanje<br>KOM |
|----------------|------|-----------------|------------------|
| 0491071        | KROM | 62012           | 1                |



**DRŽAČ POLICE I POLICA**

| Šifra<br>VOKEL | Boja | Broj<br>Artikla | Pakovanje<br>KOM |
|----------------|------|-----------------|------------------|
| 0491075        | KROM | 62016           | 1                |





## DRŽAČI SERIJA TERESA



**DOZATOR ZA TEKUĆI  
SAPUN**

| Šifra<br>VOKEL | Boja | Broj<br>Artikla | Pakovanje<br>KOM |
|----------------|------|-----------------|------------------|
| 0491078        | KROM | 62015A          | 1                |



**DRŽAČ TOALET  
PAPIRA**

| Šifra<br>VOKEL | Boja | Broj<br>Artikla | Pakovanje<br>KOM |
|----------------|------|-----------------|------------------|
| 0491070        | KROM | 62011           | 1                |



**DRŽAČ SAPUNA SA STAKLENOM  
SAPUNJAROM**

| Šifra<br>VOKEL | Boja | Broj<br>Artikla | Pakovanje<br>KOM |
|----------------|------|-----------------|------------------|
| 0491077        | KROM | 62015           | 1                |



**DRŽAČ ČAŠE SA ČAŠOM**

| Šifra<br>VOKEL | Boja | Broj<br>Artikla | Pakovanje<br>KOM |
|----------------|------|-----------------|------------------|
| 0491076        | KROM | 62014           | 1                |



**WC ČETKA**

| Šifra<br>VOKEL | Boja | Broj<br>Artikla | Pakovanje<br>KOM |
|----------------|------|-----------------|------------------|
| 0491079        | KROM | 62020           | 1                |



**VJEŠALICA**

| Šifra<br>VOKEL | Boja | Broj<br>Artikla | Pakovanje<br>KOM |
|----------------|------|-----------------|------------------|
| 0491081        | KROM | 61010           | 1                |



**DRŽAČ RUČNIKA FIKSNI  
50 cm**

| Šifra<br>VOKEL | Boja | Broj<br>Artikla | Pakovanje<br>KOM |
|----------------|------|-----------------|------------------|
| 0491089        | KROM | 61013           | 1                |



**DRŽAČ RUČNIKA FIKSNI  
60 cm**

| Šifra<br>VOKEL | Boja | Broj<br>Artikla | Pakovanje<br>KOM |
|----------------|------|-----------------|------------------|
| 0491090        | KROM | 61013           | 1                |



**DRŽAČ RUČNIKA  
POKRETNI 2/1**

| Šifra<br>VOKEL | Boja | Broj<br>Artikla | Pakovanje<br>KOM |
|----------------|------|-----------------|------------------|
| 0491092        | KROM | 61021           | 1                |



**DRŽAČ RUČNIKA VIŠECJEVNI**

| Šifra<br>VOKEL | Boja | Broj<br>Artikla | Pakovanje<br>KOM |
|----------------|------|-----------------|------------------|
| 0491091        | KROM | 61019           | 1                |



**DRŽAČ RUČNIKA  
ČETVRTASTI**

| Šifra<br>VOKEL | Boja | Broj<br>Artikla | Pakovanje<br>KOM |
|----------------|------|-----------------|------------------|
| 0491088        | KROM | 61012           | 1                |



**DRŽAČ POLICE I POLICA**

| Šifra<br>VOKEL | Boja | Broj<br>Artikla | Pakovanje<br>KOM |
|----------------|------|-----------------|------------------|
| 0491087        | KROM | 61016           | 1                |



**DOZATOR ZA TEKUĆI  
SAPUN**

| Šifra<br>VOKEL | Boja | Broj<br>Artikla | Pakovanje<br>KOM |
|----------------|------|-----------------|------------------|
| 0491085        | KROM | 61015A          | 1                |



## DRŽAČI SERIJA LILLY



**DRŽAČ TOALET  
PAPIRA**

| Šifra<br>VOKEL | Boja | Broj<br>Artikla | Pakovanje<br>KOM |
|----------------|------|-----------------|------------------|
| 0491082        | KROM | 61011           | 1                |



**DRŽAČ ZA FEN**

| Šifra<br>VOKEL | Boja | Broj<br>Artikla | Pakovanje<br>KOM |
|----------------|------|-----------------|------------------|
| 0491080        | KROM | 1300-27         | 1                |



**DRŽAČ SAPUNA SA STAKLENOM  
SAPUNJAROM**

| Šifra<br>VOKEL | Boja | Broj<br>Artikla | Pakovanje<br>KOM |
|----------------|------|-----------------|------------------|
| 0491084        | KROM | 61015           | 1                |



**DRŽAČ ČAŠE SA ČAŠOM**

| Šifra<br>VOKEL | Boja | Broj<br>Artikla | Pakovanje<br>KOM |
|----------------|------|-----------------|------------------|
| 0491083        | KROM | 61014           | 1                |



**WC ČETKA**

| Šifra<br>VOKEL | Boja | Broj<br>Artikla | Pakovanje<br>KOM |
|----------------|------|-----------------|------------------|
| 0491086        | KROM | 61020           | 1                |



**DRŽAČ RUČNIKA VIŠECIJEVNI**  
**55 cm**

| Šifra<br>VOKEL | Boja | Broj<br>Artikla | Pakovanje<br>KOM |
|----------------|------|-----------------|------------------|
| 86028          | KROM | U-550           | 1                |



**DRŽAČ RUČNIKA VIŠECIJEVNI**  
**65 cm**

| Šifra<br>VOKEL | Boja | Broj<br>Artikla | Pakovanje<br>KOM |
|----------------|------|-----------------|------------------|
| 86029          | KROM | U-650           | 1                |



**DRŽAČ SPUŽVE I SAPUNA**  
**REŠETKA**

| Šifra<br>VOKEL | Boja | Broj<br>Artikla | Pakovanje<br>KOM |
|----------------|------|-----------------|------------------|
| 86035          | KROM | KJ-1502         | 1                |



**KUTNI DRŽAČ**  
**REŠETKA**

| Šifra<br>VOKEL | Boja | Broj<br>Artikla | Pakovanje<br>KOM |
|----------------|------|-----------------|------------------|
| 86033          | KROM | KJ-1403         | 1                |



**DRŽAČ SAPUNA**  
**REŠETKA**

| Šifra<br>VOKEL | Boja | Broj<br>Artikla | Pakovanje<br>KOM |
|----------------|------|-----------------|------------------|
| 86034          | KROM | KJ-1601         | 1                |



**KUTNI ETAŽER SA**  
**2 POLICE**

| Šifra<br>VOKEL | Boja | Broj<br>Artikla | Pakovanje<br>KOM |
|----------------|------|-----------------|------------------|
| 86036          | KROM | KJ-1004         | 1                |



**KUTNI ETAŽER SA**  
**3 POLICE**

| Šifra<br>VOKEL | Boja | Broj<br>Artikla | Pakovanje<br>KOM |
|----------------|------|-----------------|------------------|
| 86037          | KROM | KJ-1003         | 1                |



**ZIDNI ETAŽER SA**  
**2 POLICE**

| Šifra<br>VOKEL | Boja | Broj<br>Artikla | Pakovanje<br>KOM |
|----------------|------|-----------------|------------------|
| 0491095        | KROM | KJ-1001         | 1                |



**ZIDNI ETAŽER SA  
2 POLICE**

| Šifra<br>VOKEL | Boja | Broj<br>Artikla | Pakovanje<br>KOM |
|----------------|------|-----------------|------------------|
| 0491094        | KROM | KJ-10           | 1                |



**OGLEDALO S POVEĆALOM**

| Šifra<br>VOKEL | Boja | Broj<br>Artikla | Pakovanje<br>KOM |
|----------------|------|-----------------|------------------|
| 86024          | KROM | KJ-11A          | 1                |



**KANTA ZA SMEĆE  
5 L**

| Šifra<br>VOKEL | Boja | Broj<br>Artikla | Pakovanje<br>KOM |
|----------------|------|-----------------|------------------|
| 86032          | KROM | 9908-5L         | 1                |



**KANTA ZA SMEĆE  
8 L**

| Šifra<br>VOKEL | Boja | Broj<br>Artikla | Pakovanje<br>KOM |
|----------------|------|-----------------|------------------|
| 0491096        | KROM | 9908-8L         | 1                |



**WC ČETKA SA NOSAČEM  
ZA ZID**

| Šifra<br>VOKEL | Boja | Broj<br>Artikla | Pakovanje<br>KOM |
|----------------|------|-----------------|------------------|
| 86020          | KROM | 9903B           | 1                |

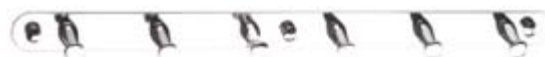

**VJEŠALICA  
SA 6 KUKICA**

| Šifra<br>VOKEL | Boja | Broj<br>Artikla | Pakovanje<br>KOM |
|----------------|------|-----------------|------------------|
| 86018          | KROM | KJ-20066        | 1                |



**UŽE ZA VJEŠANJE  
RUBLJA**

| Šifra<br>VOKEL | Boja | Broj<br>Artikla | Pakovanje<br>KOM |
|----------------|------|-----------------|------------------|
| 86019          | KROM | KJ-07           | 1                |



|                                                                                     |                |                                              |              |
|-------------------------------------------------------------------------------------|----------------|----------------------------------------------|--------------|
|    | <b>19245</b>   | TUŠ RUČICA MASAŽNA SA 5 STUPNJEVA REGULACIJE | ART.321SX    |
|    | <b>19247</b>   | TUŠ RUČICA                                   | ART.311DA    |
|    | <b>19248</b>   | TUŠ RUČICA S PREKIDAČEM                      | ART.331K47   |
|    | <b>19246</b>   | TUŠ RUČICA MASAŽNA SA 3 STUPNJA REGULACIJE   | ART.317X     |
|  | <b>0203089</b> | TUŠ RUČICA                                   | ART.311 CR   |
|  | <b>0203090</b> | TUŠ RUČICA                                   | ART.311 DABI |
|  | <b>0203091</b> | TUŠ RUČICA                                   | ART.311 MS   |
|  | <b>0203092</b> | TUŠ RUČICA SA 5 STUPNJEVA REGULACIJE         | ART.312 H    |
|  | <b>0203093</b> | TUŠ RUČICA SA 4 STUPNJA REGULACIJE           | ART.312 HT   |
|  | <b>0203094</b> | TUŠ RUČICA SA 4 STUPNJA REGULACIJE           | ART.317      |

|                                                                                     |         |                                      |             |
|-------------------------------------------------------------------------------------|---------|--------------------------------------|-------------|
|    | 0203095 | TUŠ RUČICA                           | ART.317 DM  |
|    | 0203096 | TUŠ RUČICA                           | ART.317 DS  |
|    | 0203097 | TUŠ RUČICA SA 5 STUPNJEVA REGULACIJE | ART.318     |
|   | 0203098 | TUŠ RUČICA SA 3 STUPNJA REGULACIJE   | ART.318 R   |
|  | 0203099 | TUŠ RUČICA SA 8 STUPNJEVA REGULACIJE | ART.3198 F  |
|  | 0203100 | TUŠ RUČICA                           | ART.324 CR  |
|  | 0203104 | TUŠ RUČICA                           | ART.312     |
|  | 0203101 | TUŠ RUČICA SA PREKIDAČEM             | ART.332 OLA |
|  | 0203172 | SET CRIJEVO I TUŠ RUČICA             | ART.N 60    |

|                                                                                     |                |                                                  |              |
|-------------------------------------------------------------------------------------|----------------|--------------------------------------------------|--------------|
|    | <b>0203170</b> | SET RELAX CRIJEVO, TUŠ RUČICA,<br>VENTIL I NOSAČ | ART. 332 REL |
|    | <b>0203102</b> | SET CRIJEVO I TUŠ RUČICA RELAXA                  | ART.332 RELA |
|   | <b>0203103</b> | SET CRIJEVO I TUŠ RUČICA RELAXA SQ               | ART.332 RES  |
|  | <b>90197</b>   | RUČICA ZA TUŠ S PREKIDAČEM I PVC CRIJEVOM        | ART.332      |
|  | <b>0203106</b> | IZLJEV ZA PODŽBUKNU BATERIJU                     | ART.91 S     |
|  | <b>0203171</b> | IZLJEV ZA PODŽBUKNU BATERIJU                     | ART.91 M     |
|  | <b>0203108</b> | IZLJEV ZA PODŽBUKNU BATERIJU                     | ART.91 MD    |
|  | <b>0203110</b> | IZLJEV FIKSNI ZIDNI S TUŠ RUŽOM                  | ART.350 MR   |

|                                                                                     |                |                                                                |                |
|-------------------------------------------------------------------------------------|----------------|----------------------------------------------------------------|----------------|
|    | <b>0203162</b> | NOSAČ TUŠ RUŽE 40 cm                                           | ART.34340      |
|    | <b>0203163</b> | NOSAČ TUŠ RUŽE 40 cm                                           | ART.348 S 40   |
|    | <b>0203164</b> | NOSAČ TUŠ RUŽE 40 cm                                           | ART.348 N      |
|    | <b>0203165</b> | NOSAČ TUŠ RUŽE 40 cm S IZLAZOM ZA TUŠ RUČICU I<br>PREBACIVAČEM | ART.N348 ND 40 |
|   | <b>0203166</b> | OKRUGLA TUŠ RUŽA Ø 25 cm                                       | ART.357 UF M25 |
|  | <b>0203167</b> | KVADRATNA TUŠ RUŽA 25x25 cm                                    | ART.357 UF S25 |
|  | <b>0203168</b> | PRAVOKUTNA TUŠ RUŽA 50x20x3 cm                                 | ART.350 SS     |
|  | <b>0203169</b> | PRAVOKUTNA TUŠ RUŽA 50x25x0,3 cm                               | ART.350 UF     |

|                                                                                     |                |                                              |                      |
|-------------------------------------------------------------------------------------|----------------|----------------------------------------------|----------------------|
|    | <b>0203114</b> | BATERIJA ZA KADU IZ PODA                     | ART.N08              |
|   | <b>90218</b>   | KONZOLA ZA TUŠ                               | ART.311              |
|  | <b>90205</b>   | CRIJEVO ZA TUŠ                               | ART.332120 120cm     |
|                                                                                     | <b>90553</b>   | CRIJEVO ZA TUŠ                               | ART.333CN150 150cm   |
|                                                                                     | <b>90185</b>   | CRIJEVO ZA TUŠ KONUSNO                       | ART.333CNES150 150cm |
|                                                                                     | <b>90153</b>   | CRIJEVO ZA TUŠ KONUSNO                       | ART.333CNES200 200cm |
|  | <b>90186</b>   | CRIJEVO ZA TUŠ PVC 150 cm                    | ART.332 CN 150       |
|  | <b>0203109</b> | CRIJEVO ZA TUŠ 150 cm                        | ART.332 CN MTR 150   |
|  | <b>0203085</b> | DONJI DIO SIFONA ZA UMIVAONIK NIKLOVANI 5/4" | ART.960              |





**UGRADNI ELEMENTI**

|                   |                       |                                                                                                                              |
|-------------------|-----------------------|------------------------------------------------------------------------------------------------------------------------------|
|                   | <p><b>0528001</b></p> | <p>UGRADNI VODOKOTLIĆ AlcaPLAST<br/>ALCAMODUL ZA VISEĆE WC<br/>ŠKOLJKE<br/>VISINA 1m</p> <p>ART.A100/1000</p>                |
|                   | <p><b>0528002</b></p> | <p>UGRADNI VODOKOTLIĆ AlcaPLAST<br/>SÁDROMODUL SUHA UGRADNJA<br/>VISINA 1,20m</p> <p>ART.A101/1200</p>                       |
| <p>SLIM MODUL</p> | <p><b>0528067</b></p> | <p>UGRADNI VODOKOTLIĆ AlcaPLAST<br/>SÁDROMODUL SLIM (Uski) 8 cm<br/>SUHA UGRADNJA<br/>VISINA 1,20m</p> <p>ART.A1101/1200</p> |
|                   | <p><b>0528003</b></p> | <p>UGRADNI VODOKOTLIĆ AlcaPLAST<br/>JÁDROMODUL SUHA UGRADNJA<br/>VISINA 1,20m</p> <p>ART.A102/1200</p>                       |

|  |                |                                                                     |               |
|--|----------------|---------------------------------------------------------------------|---------------|
|  | <b>0528004</b> | TIPKA ZA DVOKOLIČINSKO ISPIRANJE<br>BIJELA AlcaPLAST                | ART.M70       |
|  | <b>0528005</b> | TIPKA ZA DVOKOLIČINSKO ISPIRANJE<br>CROM-SJAJNI AlcaPLAST           | ART.M71       |
|  | <b>0528006</b> | TIPKA ZA DVOKOLIČINSKO ISPIRANJE<br>CROM-MAT AlcaPLAST              | ART.M72       |
|  | <b>0528022</b> | TIPKA ZA DVOKOLIČINSKO ISPIRANJE<br>BIJELA AlcaPLAST                | ART.M370      |
|  | <b>0528023</b> | TIPKA ZA DVOKOLIČINSKO ISPIRANJE<br>CROM-SJAJNI AlcaPLAST           | ART.M371      |
|  | <b>0528085</b> | TIPKA ZA DVOKOLIČINSKO ISPIRANJE<br>BIJELA AlcaPLAST                | ART.M1710     |
|  | <b>0528086</b> | TIPKA ZA DVOKOLIČINSKO ISPIRANJE<br>CROM-SJAJ/MAT AlcaPLAST         | ART.M1713     |
|  | <b>0528008</b> | UGRADNI MONTAŽNI ELEMENT<br>ZA UMIVAONIK AlcaPLAST<br>VISINA 1,20 m | ART.A104/1200 |
|  | <b>0528009</b> | UGRADNI MONTAŽNI ELEMENT<br>ZA BIDE AlcaPLAST<br>VISINA 1,20 m      | ART.A105/1200 |
|  | <b>0528043</b> | UGRADNI MONTAŽNI ELEMENT<br>ZA BIDE AlcaPLAST<br>VISINA 0,85 m      | ART.A105/850  |
|  | <b>0528010</b> | UGRADNI MONTAŽNI ELEMENT<br>ZA PISOAR AlcaPLAST<br>VISINA 1,20 m    | ART.A107/1200 |







## VIŠEĆI TROKADERO S REŠETKOM SET

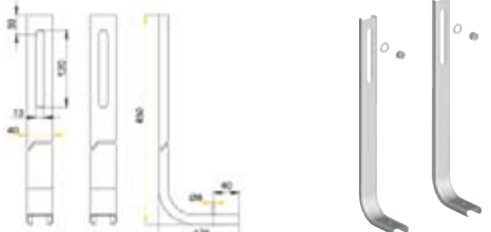
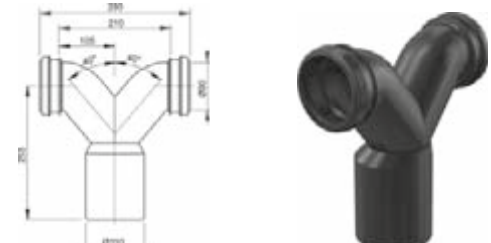

|  |                       |                                          |                       |
|--|-----------------------|------------------------------------------|-----------------------|
|  | <p><b>0528094</b></p> | <p>VIŠEĆI TROKADERO S REŠETKOM</p>       | <p>ART.WS ALCA</p>    |
|  | <p><b>0528095</b></p> | <p>PODŽBUKNI SET ZA VIŠEĆI TROKADERO</p> | <p>ART.A108F/1100</p> |
|  | <p><b>0528097</b></p> | <p>TIPKA ZA ISPIRANJE BIJELA</p>         | <p>ART.M270</p>       |
|  | <p><b>0528007</b></p> | <p>PLOČA ZA ZVUČNU IZOLACIJU</p>         | <p>ART.M91</p>        |



|                                                                                     |                       |                                                                  |                   |
|-------------------------------------------------------------------------------------|-----------------------|------------------------------------------------------------------|-------------------|
|    | <p><b>0528007</b></p> | <p>PLOČA ZA ZVUČNU IZOLACIJU<br/>AlcaPLAST</p>                   | <p>ART.M91</p>    |
|    | <p><b>0528011</b></p> | <p>NOGARE ZA UGRADNI VODOKOTLIĆ<br/>ALCAMODUL A100 AlcaPLAST</p> | <p>ART.M90</p>    |
|    | <p><b>0528068</b></p> | <p>WC PRIKLJUČAK DUPLI<br/>AlcaPLAST</p>                         | <p>ART.M909</p>   |
|  | <p><b>0528087</b></p> | <p>PRIKLJUČNA GARNITURA<br/>ZA VODOKOTLIĆ AlcaPLAST</p>          | <p>ART.M9000</p>  |
|  | <p><b>0528021</b></p> | <p>ODVODNA CIJEV<br/>AlcaPLAST</p>                               | <p>ART.M902</p>   |
|  | <p><b>0528019</b></p> | <p>KOLJENO ZA ODVOD 90°<br/>AlcaPLAST</p>                        | <p>ART.M908</p>   |
|  | <p><b>0528024</b></p> | <p>MEHANIZAM ZA VODOKOTLIĆ<br/>3/8" AlcaPLAST</p>                | <p>ART.SA2000</p> |





## UGRADNI ELEMENTI

*Pure Freude an Wasser*

# GROHE sanitarni sustavi



Kreirajte vašu modernu kupaonicu sa nizom GROHE instalacija i sustava ispiranja za WC školjke. Životni stil se mijenja i tehnološki napredak je transformirao kupaonicu iz čisto funkcionalnog prostora u prostor kuće koji odiše blagošću i uzbuđenjem. Naša je želja bila da kreiramo prostor koji će biti relaksirajući i naporan rad jerezultirao moderniziranim prostorima kupaonice gdje se ističu samo lijepi i ključni elementi opreme kupaonice. Naš asortiman sanitarnih sustava dopušta nam da kreiramo kupaonicu iz vaših snova, nudeći izbor brzih i sigurnih načina za pričvršćenje na zid sanitarne opreme i niza usavršenih rješenja za ispiranje WC školjke.

Pritiskom na veliki gumb školjka se ispire sa punom količinom vode.

Pritiskom na Eco gumb ispire sa smanjenom količinom od tri litre vode.

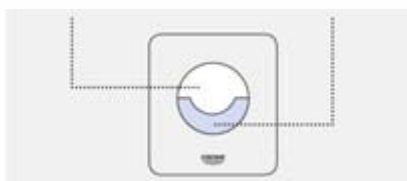

Odaberite tehnologiju dvojnog ispiranja i uštedite do 50% vode. Naše ploče za dvojno ispiranje WC školjki omogućuju vam da odredite koliko vode želite koristiti za ispiranje.

## Suvremeni prostori

Sanitarna oprema kupaonice dovela nas je do kreiranja suvremenog izgleda i danas predstavlja preferirani izbor mnogih vlasnika kuća kojima se više ne dopadaju nezgrapni umivaonici sa podnožjem i starinski WC-i. Vizualno čak i najmanja kupaonica izgledati će veća budući da je pod čist i svjetao i bez neuglednih uglova kupaonice u kojima se skuplja prljavština, a čišćenje će biti brzo i jednostavno.

## Izbor i fleksibilnost

Bez obzira na veličinu i oblik vaše kupaonice, sa Rapid SL se više ne osjećate ograničeni u četiri zida. Zahvaljujući našem svestranom sustavu okvira, izbor rasporeda i dizajna vaše kupaonice je bezgraničan - jedina granica je vaša imaginacija. Zidovi srednje i pune visine mogu se uvući ne samo u vlažnu „zonu“ i u suhe prostore, nego pružaju i dodatni prostor umivaonicima i bideima, dok vam naša rješenja za uglove kupaonice dopuštaju korištenje skućenih prostora.

GROHE skriveni WC kotlići idealni su za instaliranje u dio namještaja kupaonice ili šupljinu zida, skriveni od pogleda.

## Jednostavno instaliranje

Bez obzira da li planirate novi projekt ili modernizaciju vaše postojeće kupaonice, naši Rapid SL sustavi okvira omogućit će vam opremanje kupaonice bez gnjavaže. Okviri se mogu ugraditi u postojeće zidove kupaonice ili postaviti ispred opeke ili zida, tako da nema potrebe trošiti vrijeme i novac na zasjecanje starog pokrova. Okvir se jednostavno pričvrsti na mjestu postavljanja tijekom novogradnje ili adaptacije vaše kupaonice i sakrije iza zida.

## Dizajn i tehnologija

Kao što je slučaj sa svim našim proizvodima, Rapid SL nudi i ostale koristi. Naši skriveni kotlići su nevjerojatno tihi kod puštanja vode, a još tiši ako se kotlić pričvršćuje na instalacijski okvir umjesto na zid. Ovi kotlići mogu biti opremljeni pločama za dvojno ili jedno ispiranje WC školjke, a predviđeni su da kompletiraju naše kolekcije baterija - odaberite model sa dvojnim ispiranjem i uštedjet ćete na vodi zahvaljujući manjoj količini vode.

Za ostale informacije o Rapid SL i instaliranju zidnih okvira, molimo posjetite nas na našoj web stranici [www.grohe.hr](http://www.grohe.hr) ili proučite našu specijalnu brošuru o sanitarnim sustavima.

## Sanitarni sustavi Rapid SL

Rapid SL sustav pruža vam slobodu da dizajnirate vašu kupaonicu uz pomoć pouzdanog i brzog postupka instaliranja zidnih kotlića, bidea i WC-a. Mogu se dobiti u tri različite instalacijske visine, a svaki okvir se isporučuje predmontiran sa pričvršćenjima sanitarnih uređaja i u tvornici se podvrgava strogom ispitivanju - naši WC okviri se ispituju na opterećenje od 400 kg.



**38 528 001**  
Rapid SL za WC  
**38.528.001** 1,13 m visine  
**38.525.001** 1,00 m visine  
**38.526.000** 0,82 m visine

**38 554 001**  
Rapid SL za umivaonik

**38 553 001**  
Rapid SL za bide

**38 786 001**  
Rapid SL za pisoar  
1,13 m visine



# GROHE Uniset instalacijski sustavi

GROHE instalacijski sustavi ne poznaju komplicirane tokove montaže. Posebno su jednostavni i sigurni za montažu i ne predstavljaju nikakve poteškoće instalaterima. Predstavljamo Vam instalacijske sustave za mokru ugradnju Uniset, namijenjene za WC školjke, pisoare, umivaonike i bide.



**38 643 001**  
Uniset za WC



**38 785 000**  
Uniset za pisoar



**37 576 000**  
Uniset za umivaonik



**37 578 001**  
Uniset za bide

# GROHE ploče za ispiranje

Naše zidne ploče za ispiranje WC školjki dostupne su u većem broju stilova i dati će završni štih vašoj kupaonici. Mogu se pričvrstiti vertikalno ili horizontalno, tako da su usklađene sa uzorkom vaših keramičkih pločica i mogu se lako skinuti kako bi se omogućio pristup kotliću. Naše Surf i Skate izvedbe mogu se uklopiti u moderan i tradicionalni interijer kupaonice i mogu raditi sa dvojnim ispiranjem ili sa jednim ispiranjem WC školjke. Ili se ove ploče mogu odabrati da budu usklađene sa dizajnom keramičkih pločica, specifično za neki od naših modela baterija za kupaonice.



**38 766 K50**  
GROHE Ondus®  
zidna ploča za dvojno ispiranje



**38.732.000**  
Skate Cosmopolitan  
zidna ploča za dvojno ispiranje  
**38.732.SD0**  
Skate Cosmopolitan zidna  
ploča za dvojno ispiranje, od  
nehrđajućeg čelika



**38 765 000**  
Nova Cosmopolitan  
zidna ploča za dvojno ispiranje

1) 2)



**38 766 K50**  
GROHE Ondus®  
zidna ploča za dvojno ispiranje



**38 732 000**  
Skate Cosmopolitan  
zidna ploča za dvojno ispiranje



**38 765 000**  
Nova Cosmopolitan  
zidna ploča za dvojno ispiranje

1) 2)



GROHE EcoJoy®



GROHE StarLight®



reddot design award  
winner 2009



**38 505 000**  
Skate Air  
zidna ploča za dvojno ispiranje



**38 862 000**  
Skate  
zidna ploča za dvojno ispiranje



**38 861 000**  
Surf  
zidna ploča za dvojno ispiranje



**38 844 000**  
Arena Cosmopolitan  
zidna ploča za jedno ispiranje



**38 574 000**  
Surf  
zidna ploča za jedno ispiranje



**38.573.000**  
Skate zidna ploča za jedno  
ispiranje  
**38.672.SD0**  
Skate zidna ploča za dvojno  
ispiranje, od nhrđajućeg čelika



**38 506 000**  
Skate Air  
zidna ploča za dvojno ispiranje



**38 862 000**  
Skate  
zidna ploča za dvojno ispiranje



**38 861 000**  
Surf  
zidna ploča za dvojno ispiranje



**38 858 000**  
Arena Cosmopolitan  
zidna ploča za jedno ispiranje



**38 574 000**  
Surf  
zidna ploča za jedno ispiranje



**38 573 000**  
Skate  
zidna ploča za jedno ispiranje



# GROHE Nova Light

Svijetli u tami.



Uzimajući u obzir estetiku dizajna GROHE Cosmopolitan miješalica i tuševa, nova zidna ploča za ugradbene vodokotliče Nova Light prati dva osnovna geometrijska oblika. Ova jednostavna kombinacija kruga uramljenog u pravokutnik donosi do sada neviđenu inovaciju u sanitarnoj industriji: Obruč oko tipke za malu i veliku nuždu je osvijetljen i nježno isijava obojani sjaj u okolinu. LED tehnologija, koja je korištena u ovom obruču, omogućuje Vam da postavite bilo koju boju da svijetli – plavu, zelenu, crvenu, žutu ili neki od tonova između njih. Ako želite još dinamičniju tipku, možete postavke namjestiti i tako da se obruč neprekidno mijenja, iz boje u boju. Napravljena uz **GROHE StarLight®** tehnologiju, Nova Light se može postaviti horizontalno ili vertikalno, te se može programirati da se u određeno vrijeme osvjetljenje samo isključi. Recimo, preko dana je kupaonica dovoljno osvijetljena pa ćete tada isključiti osvjetljenje obruča, a po noći, kada je kontrast veći, možete ga ponovno uključiti.



**38 809 000**

Nova Light zidna ploča za dvojno ispiranje, sa LED osvjetljenjem



design award 2009



reddot design award winner 2009



GROHE StarLight®

# GROHE Fresh

Svježina na potisak tipke.

Stvaranje inovativnih rješenja za svakodnevne probleme je nama u GROHE-u nešto na što smo doista ponosni. GROHE Fresh donosi potpuno novu razinu praktičnosti u Vašu kupaonicu. Zaboravite na nehigijenske osvježivače koje morate ovisiti na rub WC školjke i kasnije ih, prljave, rukama ukloniti. Pomoću GROHE Fresh rješenja, vršcima prstiju jednostavno otvorite zidnu (potisnu) ploču Vašeg ugradbenog vodokotliča, postavite GROHE Fresh koljeno unutar vodokotliča i dodajte mirisnu tableticu u za to predviđenu posudicu. Tako će, kada svaki idući put potisnete tipku za malu ili veliku nuždu, poteći obojana i mirisna voda.

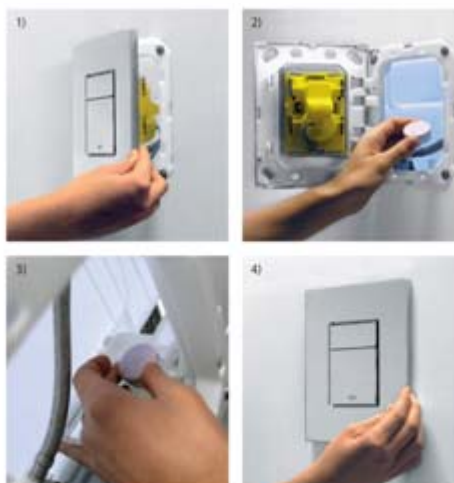

**38 796 000**

GROHE Fresh ugradbeni set za mirisne tablete



**38 797 000**

GROHE Fresh ugradbeni set za mirisne tablete, sa AV1 pneumatskim ventilom



**38 805 000**

GROHE Fresh ugradbeni set za mirisne tablete, sa Skate Cosmopolitan zidnom pločom



**38 799 000**

GROHE Fresh ugradbeni set za mirisne tablete, sa Nova Cosmopolitan zidnom pločom



**38 798 000**

GROHE Fresh ugradbeni set za mirisne tablete, sa Skate Air zidnom pločom



GROHE Cosky®



GROHE StarLight®

# GROHE Nova Cosmopolitan Print

Grafički printevi za modernu kupaonicu.



Sa svojim osvježavajućim dizajnom i različitim printevima, Nova Cosmopolitan donosi uzbudljive moderne elemente u naš široki program aktivacijskih ploča za vodikotliče. Njezina igra sa geometrijskim oblicima - stavljanje gumba u obliku kruga u okvir pravokutne ploče - čini je idealnim izborom za suvremene prostore.

Grafički printevi su idealan odabir za avangardne kupaonice, a izbor njihovih boja omogućuje da se ovaj moderni dizajn upotpuni sa nekoliko naših kolekcija armatura i tuševa.



**38 847 KI0**  
Nova Cosmopolitan  
zidna ploča, crna/krom



**38 847 LI0**  
Nova Cosmopolitan  
zidna ploča, bijela/krom



**38 847 LS0**  
Nova Cosmopolitan  
zidna ploča, Moon White



**38 847 XG0**  
Nova Cosmopolitan  
zidna ploča, crna grafika



**38 869 XG0**  
Nova Cosmopolitan  
zidna ploča, crna grafika

# GROHE Skate Cosmopolitan Glass

Staklene aktivacijske ploče.



Kako se dizajn kupatila razvija, keramičke pločice sve više i više otvaraju prostora za inovativne aktivacijske ploče za vodokotiče. Najnoviji trend je staklo.

Čista, moderna i privlačna - Skate Cosmopolitan staklena ploča ima mekane i polirane rubove zadivljujuće preciznosti i kvalitete. Sa 6 mm debljine, sjajnu površinu ove ploče naglašava kromirani premaz **GROHE Starlight®**.

Izbor od četiri vrste stakla uključuje između ostalog crnu i bijelu boju, koje se mogu iskoristiti za nadopunjavanje s novim crnim i bijelim armaturama iz naše Quadra kolekcije. Skate Cosmopolitan staklene tipke uključuju modele za WC i pisoar, omogućavajući cjelovitu koordinaciju dizajna Vaše kupaonice.



**38 845 K50**  
Skate Cosmopolitan staklena-zidna ploča, krom/velvet crna Velvet



**38 845 L50**  
Skate Cosmopolitan staklena-zidna ploča, krom/Moon White



**38 845 M50**  
Skate Cosmopolitan staklena-zidna ploča, krom/davinci satin



**38 845 B50**  
Skate Cosmopolitan staklena-zidna ploča, krom/titan



**38 846 K50**  
Skate Cosmopolitan staklena-zidna ploča za pisoar krom/velvet crna



**38 846 L50**  
Skate Cosmopolitan staklena-zidna ploča za pisoar krom/Moon White



**38 846 M50**  
Skate Cosmopolitan staklena-zidna ploča za pisoar krom/davinci satin



**38 846 B50**  
Skate Cosmopolitan staklena-zidna ploča za pisoar krom/titan

# GROHE Skate Cosmopolitan Wood

Izaberite prirodno drvo za bezvremensku eleganciju.



Bezvremenski i trajan, malo materijala može konkurirati drvetu kada se radi o dodavanju topline interijerima. GROHE Skate Cosmopolitan Wood program se nudi u šest varijanti stvarnog, prirodnog drveta koji će upotpuniti najnovije stilove namještaja za kupaonice

Od osvježavajućeg bambusa do bogatih tonova Macassar, ove drvene ploče zrače izvornošću pravog drveta, kojeg dodatno naglašava obruč od visokosjajnog **GROHE Starlight®** kroma. Podrijetlom od ovjereni dobavljača, šare ovog prirodnog drveta ni kod jedne ploče nisu iste - što daruje unikatan izgled Vašoj kupaonici. Diskretnih mjera 197x156 mm, ove se tipke mogu postaviti horizontalno ili vertikalno.



**38 849 HPO**  
Skate Cosmopolitan drvena  
zidna ploča, američki orah



**38 849 HR0**  
Skate Cosmopolitan drvena  
zidna ploča, Macassar



**38 849 HS0**  
Skate Cosmopolitan drvena  
zidna ploča, američka trešnja



**38 849 HWD**  
Skate Cosmopolitan drvena  
zidna ploča, hrast



**38 849 HT0**  
Skate Cosmopolitan drvena  
zidna ploča, maslina



**38 849 HVO**  
Skate Cosmopolitan drvena  
zidna ploča, bambus



# GROHE Skate Cosmopolitan Print

Print teksture koje neodoljivo upadaju u oko.



Dok se dizajn tipke Nova Cosmopolitan temelji na kružnici, kod Skate Cosmopolitan tipke dominiraju pravokutni oblici. Optički uzorci se koriste za stvaranje trodimenzionalnog efekta, što dovodi do isticanja čistoće **GROHE Starlight®** kromiranog gumba.

Skate Cosmopolitan je dostupan i u titan varijanti, sa zaštitom protiv otisaka prstiju - što ga čini savršenim izborom za prostore sa velikim protokom ljudi.



**GROHE tehnologija:**  
AntiFingerPrint

**38 732 BR0**  
Skate Cosmopolitan  
zidna ploča, Anti Fingerprint



**38 859 XGO**  
Skate Cosmopolitan Print  
zidna ploča



GROHE EcoJoy™



GROHE StarLight™

# GROHE Arena Cosmopolitan

Vidljivo drugačija.



GROHE vizualna DNA omogućava kupcima da prepoznaju kvalitetu naše tvrtke u trenu. Središnji element te DNA filozofije je primjena oblika pastile, koja se može naći u nekoliko naših linija proizvoda.

Na tipkama GROHE Arena Cosmopolitana taj se oblik pastile pokazao na izuzetno mekan način, gotovo da privlači da je dodirnete. Dostupne su u **GROHE Starlight®** krom, mat krom i bijeloj varijanti, a njihovim dizajnom možete na jednostavan način upotpuniti interijer i nekom od GROHE miješalica. U liniju su uključene i tipke za pisoar.



**38 844 000**  
Arena Cosmopolitan  
zidna ploča



**38 857 000**  
Arena Cosmopolitan  
zidna ploča za pisoar



GROHE EcoJoy™



GROHE StarLight™



|  |                       |                                                                                                     |
|--|-----------------------|-----------------------------------------------------------------------------------------------------|
|  | <p><b>0531016</b></p> | <p>UGRADNI VODOKOTLIĆ GROHE RAPID SL SET<br/>SUHA UGRADNJA<br/>ART.38528001</p>                     |
|  | <p><b>0531029</b></p> | <p>UGRADNI VODOKOTLIĆ GROHE RAPID<br/>SUHA UGRADNJA, VISINA = 0,82 m<br/>ART.38526000</p>           |
|  | <p><b>0531001</b></p> | <p>SET ZA PRIČVRŠĆIVANJE<br/>ART.3855800M</p>                                                       |
|  | <p><b>0531018</b></p> | <p>UGRADNI VODOKOTLIĆ GROHE UNISET<br/>ZA VISEĆE WC ŠKOLJKE<br/>MOKRA UGRADNJA<br/>ART.38643001</p> |
|  | <p><b>0531039</b></p> | <p>FRESH SET ZA VODOKOTLIĆ<br/>(OKVIR ZA TIPKU S POSUDOM ZA<br/>HIGIJENSKE TABLETE)</p>             |

|                                                                                     |                                                                                     |                |                                                                                       |              |
|-------------------------------------------------------------------------------------|-------------------------------------------------------------------------------------|----------------|---------------------------------------------------------------------------------------|--------------|
|    |    | <b>0531015</b> | TIPKA ZA DVOKOLIČINSKO ISPIRANJE<br>SKATE COSMOPOLITAN BIJELA                         | ART.38732SH0 |
|                                                                                     |                                                                                     | <b>0531017</b> | TIPKA ZA DVOKOLIČINSKO ISPIRANJE<br>SKATE COSMOPOLITAN CROM                           | ART.38732000 |
|    |    | <b>0531004</b> | TIPKA ZA DVOKOLIČINSKO ISPIRANJE<br>SKATE AIR BIJELA                                  | ART.38505SH0 |
|                                                                                     |                                                                                     | <b>0531005</b> | TIPKA ZA DVOKOLIČINSKO ISPIRANJE<br>SKATE AIR CROM                                    | ART.38505000 |
|    |    | <b>0531022</b> | TIPKA ZA DVOKOLIČINSKO ISPIRANJE<br>NOVA COSMOPOLITAN BIJELA                          | ART.38765SH0 |
|                                                                                     |                                                                                     | <b>0531023</b> | TIPKA ZA DVOKOLIČINSKO ISPIRANJE<br>NOVA COSMOPOLITAN CROM                            | ART.38765000 |
|    |    | <b>0531024</b> | TIPKA ZA DVOKOLIČINSKO ISPIRANJE<br>NOVA COSMOPOLITAN BIJELA/CROM                     | ART.38847LI0 |
|  |  | <b>0531025</b> | TIPKA ZA DVOKOLIČINSKO ISPIRANJE<br>NOVA COSMOPOLITAN CRNA/CROM                       | ART.38847KI0 |
|  |  | <b>0531026</b> | TIPKA ZA DVOKOLIČINSKO ISPIRANJE<br>SKATE COSMOPOLITAN BIJELA<br>SA STAKLENIM OKVIROM | ART.38845LS0 |
|  |  | <b>0531027</b> | TIPKA ZA DVOKOLIČINSKO ISPIRANJE<br>SKATE COSMOPOLITAN CRNA<br>SA STAKLENIM OKVIROM   | ART.38845KS0 |
|  |  | <b>0531034</b> | TIPKA ZA DVOKOLIČINSKO ISPIRANJE<br>ARENA COSMOPOLITAN CROM<br>HORIZONTALNA IZVEDBA   | ART.38858000 |
|  |  | <b>0531045</b> | TIPKA ZA DVOKOLIČINSKO ISPIRANJE<br>ARENA COSMOPOLITAN CROM<br>VERTIKALNA IZVEDBA     | ART.38844000 |
|  |  | <b>0531030</b> | SENZORSKA INOX TIPKA ZA VODOKOTLIĆ<br>TECTRON SKATE S TRAFOM 230V                     | ART.38698SD0 |

|  |                       |                                                              |                     |
|--|-----------------------|--------------------------------------------------------------|---------------------|
|  | <p><b>0531019</b></p> | <p>UGRADNI MONTAŽNI ELEMENT<br/>ZA PISOAR GROHE RAPID SL</p> | <p>ART.38786001</p> |
|  | <p><b>0531020</b></p> | <p>TIPKA ZA PISOAR SURF CROM</p>                             | <p>ART.38808000</p> |
|  | <p><b>0531036</b></p> | <p>TIPKA ZA PISOAR<br/>NOVA COSMOPOLITAN BIJELA</p>          | <p>ART.38804SH0</p> |
|  | <p><b>0531035</b></p> | <p>TIPKA ZA PISOAR<br/>NOVA COSMOPOLITAN CROM</p>            | <p>ART.38804000</p> |
|  | <p><b>0531038</b></p> | <p>TIPKA ZA PISOAR<br/>SKATE COSMOPOLITAN BIJELA</p>         | <p>ART.38784SH0</p> |
|  | <p><b>0531037</b></p> | <p>TIPKA ZA PISOAR<br/>SKATE COSMOPOLITAN CROM</p>           | <p>ART.38784000</p> |
|  | <p><b>0531031</b></p> | <p>TECTRON SKATE GROHE<br/>VANJSKO NAPAŽANJE 230V</p>        | <p>ART.37321000</p> |
|  | <p><b>0531032</b></p> | <p>TECTRON SKATE GROHE<br/>BATERIJSKO NAPAŽANJE 6V</p>       | <p>ART.37324000</p> |
|  | <p><b>0531033</b></p> | <p>UGRADBENI SET ZA PISOAR<br/>RAPIDO U</p>                  | <p>ART.37338000</p> |

|  |                       |                                                                                                 |
|--|-----------------------|-------------------------------------------------------------------------------------------------|
|  | <p><b>0531010</b></p> | <p>UGRADNI MONTAŽNI ELEMENT ZA UMIVAONIK GROHE RAPID SL ART.38554001</p>                        |
|  | <p><b>0531011</b></p> | <p>UGRADNI MONTAŽNI ELEMENT ZA BIDE GROHE RAPID SL ART.38553001 (38553000)</p>                  |
|  | <p><b>0531001</b></p> | <p>SET ZA PRIČVRŠĆIVANJE ART.3855800M</p>                                                       |
|  | <p><b>0531044</b></p> | <p>UGRADNI ELEMENT ZA FIKSIRANJE POMOĆNIH DRŽAČA ZA OSOBE S POSEBNIM POTREBAMA ART.38559001</p> |
|  | <p><b>0531028</b></p> | <p>VODOKOTLIĆ PVC BIJELI ART.37355SH0</p>                                                       |
|  | <p><b>0531040</b></p> | <p>ULJEVNI VENTIL PLOVAK ZA VODOKOTLIĆ GROHE ART.37095000</p>                                   |
|  | <p><b>0531041</b></p> | <p>VEZNA CIJEV ZA VODOKOTLIĆ GROHE ART.42233000</p>                                             |
|  | <p><b>0531042</b></p> | <p>IZLJEVNI VENTIL ODSISAČ ZA VODOKOTLIĆ GROHE ART.42320000</p>                                 |



## UGRADNI ELEMENTI

Sustavi za kreativno oblikovanje kupaonice.



**viega**





**40450** VODOKOTLIČ UGRADNI "ECO PLUS" ART.606664

**40784** NOSAČ ZA BIDE "MONO" ART.421168

**40489** NOSAČ ZA BIDE "ECO PLUS" ART.727901

**40442** VODOKOTLIČ UGRADNI "MONO" ART.606732  
**40445** NOGICE KONZOLNE ZA VODOKOTLIČ "MONO" ART.400767



**40562** NOSAČ ZA UMIVAONIK "ECO PLUS" ART.367138





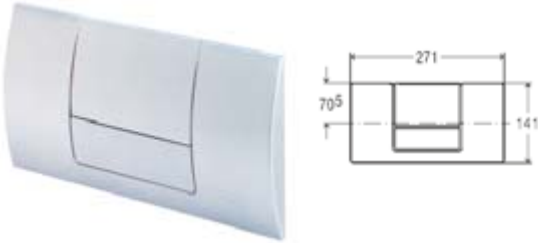
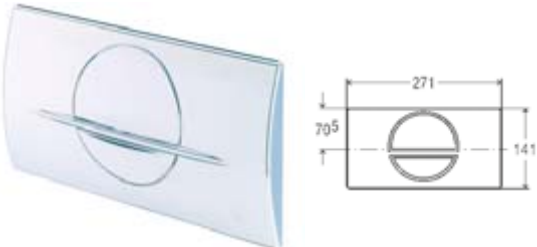
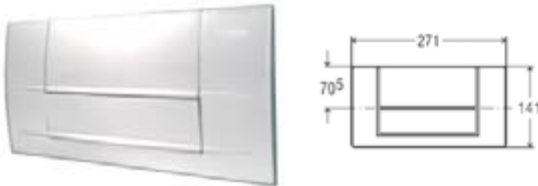
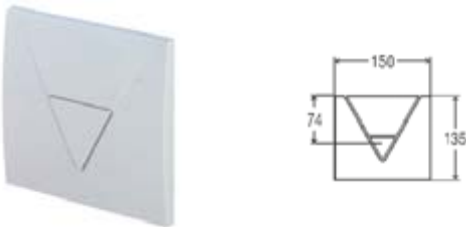
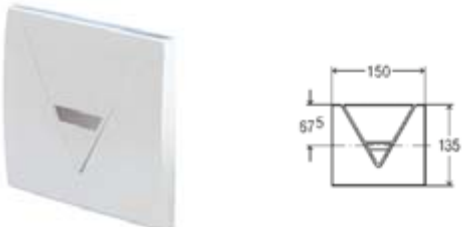

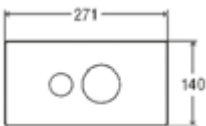

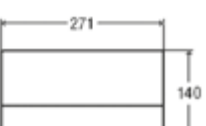
**40954** VODOKOTLIČ "ECO PLUS" 83 cm ART.606701

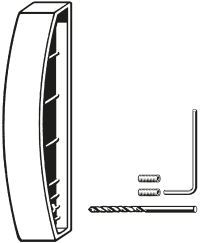

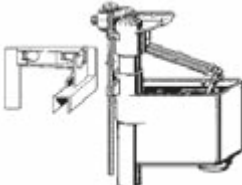

**40667** NOSAČ ZA PISOAR "ECO PLUS" ART.461843

**0520084** UGRADNI VODOKOTLIČ "ECO LIGHT" ART.606688

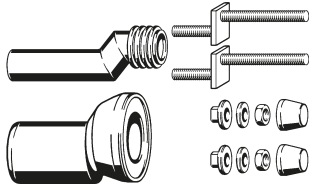
|                                                                                     |                |                                                                                    |
|-------------------------------------------------------------------------------------|----------------|------------------------------------------------------------------------------------|
|    | <b>0520054</b> | TIPKA ZA VODOKOTLIĆ VIEGA STANDARD<br>"ECO PLUS"BIJELA<br>ART.449001               |
|                                                                                     | <b>0520056</b> | TIPKA ZA VODOKOTLIĆ VIEGA STANDARD<br>"ECO PLUS" CROM<br>ART.449018                |
|                                                                                     | <b>0520075</b> | TIPKA ZA VODOKOTLIĆ VIEGA STANDARD<br>"ECO PLUS" INOX MAT<br>ART.449032            |
|    | <b>0520062</b> | TIPKA ZA VODOKOTLIĆ "MONO" I "ECO"<br>INOX<br>ART.463090                           |
|  | <b>0520063</b> | TIPKA ZA VODOKOTLIĆ VISIGN 3<br>BIJELA<br>ART.463038                               |
|  | <b>40980</b>   | POTISNA PLOČA ZA PISOAR "ECO"<br>CROM<br>ART.448806                                |
|  | <b>40778</b>   | POTISNA PLOČA ZA PISOAR "ECO" SA<br>FOTOČELIJOM CROM 230V (Mreža)<br>ART.476656    |
|                                                                                     | <b>0520082</b> | POTISNA PLOČA ZA PISOAR "ECO" SA<br>FOTOČELIJOM BRUŠENO 230V (Mreža)<br>ART.403911 |
|                                                                                     | <b>40983</b>   | POTISNA PLOČA ZA PISOAR "ECO" SA<br>FOTOČELIJOM CROM 9V (Baterija)<br>ART.476441   |

|                                                                                                                                                                         |         |                                          |            |
|-------------------------------------------------------------------------------------------------------------------------------------------------------------------------|---------|------------------------------------------|------------|
|       | 0520064 | TIPKA ZA VODOKOTLIĆ<br>STYLE 10 BIJELA   | ART.596316 |
|                                                                                                                                                                         | 0520065 | TIPKA ZA VODOKOTLIĆ<br>STYLE 10 CROM     | ART.596323 |
|                                                                                                                                                                         | 0520076 | TIPKA ZA VODOKOTLIĆ<br>STYLE 10 INOX-MAT | ART.596347 |
|       | 0520066 | TIPKA ZA VODOKOTLIĆ<br>STYLE 11 BIJELA   | ART.597108 |
|                                                                                                                                                                         | 0520067 | TIPKA ZA VODOKOTLIĆ<br>STYLE 11 CROM     | ART.597115 |
|                                                                                                                                                                         | 0520077 | TIPKA ZA VODOKOTLIĆ<br>STYLE 11 INOX-MAT | ART.597139 |
|   | 0520068 | TIPKA ZA VODOKOTLIĆ<br>STYLE 12 BIJELA   | ART.596743 |
|                                                                                                                                                                         | 0520087 | TIPKA ZA VODOKOTLIĆ<br>STYLE 12 INOX MAT | ART.597276 |
|                                                                                                                                                                         | 0520071 | TIPKA ZA VODOKOTLIĆ<br>STYLE 12 CROM     | ART.597252 |
|   | 0520069 | TIPKA ZA VODOKOTLIĆ<br>MORE 100 CROM     | ART.597436 |
|   | 0520070 | TIPKA ZA VODOKOTLIĆ<br>MORE 101 CROM     | ART.597368 |

|                                                                                     |                |                                                                  |            |
|-------------------------------------------------------------------------------------|----------------|------------------------------------------------------------------|------------|
|    | <b>40633</b>   | OSIGURAČ ZA TIPKU VODOKOTLIČA<br>MONO-ECO                        | ART.422318 |
|    | <b>40274</b>   | LETVA ŽELJEZNA L=3 m ZA<br>UGRADBENI VODOKOTLIČ                  | ART.283872 |
|    | <b>40684</b>   | VIJCI ZA VODOKOTLIČ "ECO"                                        | ART.460440 |
|    | <b>0520061</b> | POTISNA MEHANIKA                                                 | ART.407582 |
|  | <b>0520060</b> | GARNITURA VENTILA ZA PUNJENJE                                    | ART.405656 |
|  | <b>0520059</b> | GARNITURA ODVODNIH VENTILA                                       | ART.405564 |
|  | <b>0510075</b> | BRTVA ZA SJEDIŠTE VENTILA                                        | ART.407476 |
|  | <b>0510076</b> | BRTVA CIJEVI ZA ISPIRANJE                                        | ART.407698 |
|  | <b>40639</b>   | PRIKLJUČNA WC GARNITURA ZA MONO I ECO<br>VODOKOTLIČE DN 90x180mm | ART.263812 |
|  | <b>40661</b>   | WC PRIKLJUČAK EXCENTRIČNI<br>ZA UGRADNE VODOKOTLIČE              | ART.344382 |

|                                                                                     |                |                                                     |                   |
|-------------------------------------------------------------------------------------|----------------|-----------------------------------------------------|-------------------|
|    | <p>0520078</p> | <p>ODVODNI VENTIL ZA VODOKOTLIĆ</p>                 | <p>ART.611224</p> |
|    | <p>0520096</p> | <p>GARNITURA ODVODNIH VENTILA</p>                   | <p>ART.604097</p> |
|   | <p>40646</p>   | <p>REDUKCIJA ZA VODOKOTLIĆ "ECO"</p>                | <p>ART.440459</p> |
|  | <p>40795</p>   | <p>ODVODNO KOLJENO ZA UGRADNE VODOKOTLIĆE 40/50</p> | <p>ART.331160</p> |
|  | <p>0520058</p> | <p>URINALNA DOVODNA ARMATURA 1/2 x 45</p>           | <p>ART.463007</p> |





WC splakovalnik "Laguna" - Dvojni izpust • Water cistern "Laguna" - Double water outflow • Spülkasten "Laguna" - Doppelwasserablaß  
Cassetta di scarico "Laguna" - Scarico doppio di acqua • WC kotlić "Laguna" - Dvojni ispust vode



01 - 0063 - WNE



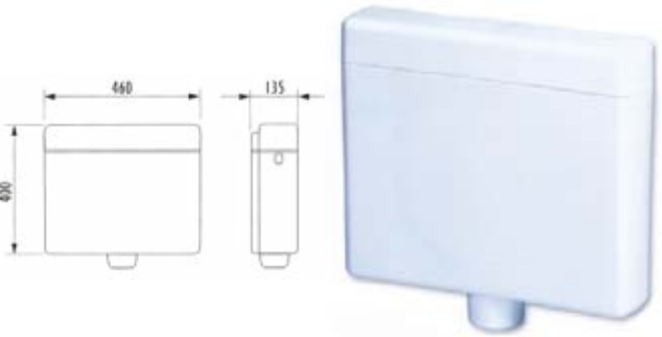

art. 5-360-500  
ident I2180

Dvojni izpust vode  
Double water outflow  
Doppelwasserablaß  
Scarico doppio di acqua  
Dvojni ispust vode

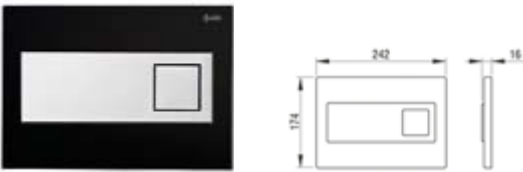

|                                                                                     |                                                                                                     |                                                                                                                                                                                                                                                                                                                                                                 |
|-------------------------------------------------------------------------------------|-----------------------------------------------------------------------------------------------------|-----------------------------------------------------------------------------------------------------------------------------------------------------------------------------------------------------------------------------------------------------------------------------------------------------------------------------------------------------------------|
|    | <p><b>03001</b></p> <p><b>03002</b></p> <p><b>03004</b></p> <p><b>03003</b></p> <p><b>03005</b></p> | <p>VODOKOTLIĆ LAGUNA<br/>BIJELO UNIVERZALNI ART.(48469)<br/>196519</p> <p>VODOKOTLIĆ LAGUNA<br/>BERMUDA UNIVERZALNI ART.(49393)<br/>196691</p> <p>VODOKOTLIĆ LAGUNA<br/>BEŽ UNIVERZALNI ART.(48875)<br/>196563</p> <p>VODOKOTLIĆ LAGUNA<br/>CALIPSO UNIVERZALNI ART.(48910)<br/>196593</p> <p>VODOKOTLIĆ LAGUNA<br/>SIVO UNIVERZALNI ART.(48881)<br/>196567</p> |
|   | <p><b>03032</b></p>                                                                                 | <p>VODOKOTLIĆ LAGUNA<br/>BIJELO S DVIJE TIPKE<br/>UNIVERZALNI ART.(12180)<br/>195357</p>                                                                                                                                                                                                                                                                        |
|  | <p><b>03024</b></p>                                                                                 | <p>VODOKOTLIĆ VISION<br/>BIJELO UNIVERZALNI ART.(10360)<br/>195200</p>                                                                                                                                                                                                                                                                                          |
|  | <p><b>03023</b></p>                                                                                 | <p>VODOKOTLIĆ CIKLON<br/>BIJELO UNIVERZALNI ART.(11600)<br/>195292</p>                                                                                                                                                                                                                                                                                          |

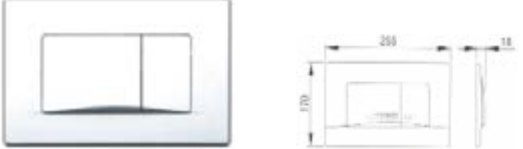
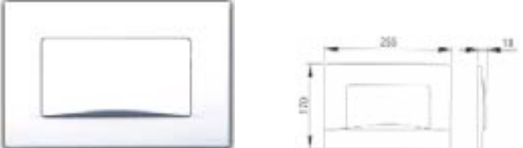

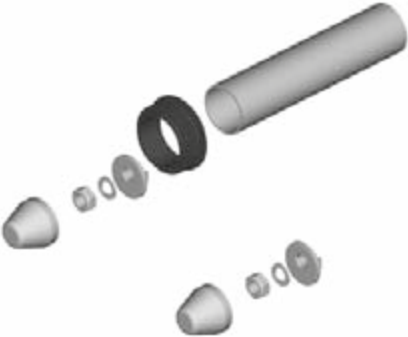
|                                                                                     |                                                                   |                                                                                                                                                                                                                                                                                |
|-------------------------------------------------------------------------------------|-------------------------------------------------------------------|--------------------------------------------------------------------------------------------------------------------------------------------------------------------------------------------------------------------------------------------------------------------------------|
|    | <p><b>0513032</b></p>                                             | <p>TIPKA ZA VODOKOTLIĆ HERCUL RUBY-ECO CRNA</p> <p>ART.223108</p>                                                                                                                                                                                                              |
|    | <p><b>0513018</b></p> <p><b>0513019</b></p> <p><b>0513020</b></p> | <p>TIPKA ZA VODOKOTLIĆ JOG SELENITE ECO <b>DUO</b> BIJELA</p> <p>ART.(15622) 195853</p> <p>TIPKA ZA VODOKOTLIĆ JOG SELENITE ECO <b>DUO</b> SJAJNI KROM</p> <p>ART.(15690) 195872</p> <p>TIPKA ZA VODOKOTLIĆ JOG SELENITE ECO <b>DUO</b> MAT KROM</p> <p>ART.(15672) 195868</p> |
|    | <p><b>0513026</b></p> <p><b>0513028</b></p> <p><b>0513027</b></p> | <p>TIPKA ZA VODOKOTLIĆ JOG SELENITE <b>STOP</b> BIJELA</p> <p>ART.(15630) 195854</p> <p>TIPKA ZA VODOKOTLIĆ JOG SELENITE <b>STOP</b> SJAJNI KROM</p> <p>ART.(15700) 195873</p> <p>TIPKA ZA VODOKOTLIĆ JOG SELENITE <b>STOP</b> MAT KROM</p> <p>ART.(15680) 195869</p>          |
|  | <p><b>0513021</b></p> <p><b>0513022</b></p> <p><b>0513023</b></p> | <p>TIPKA ZA VODOKOTLIĆ JOG APLITE ECO <b>DUO</b> BIJELA</p> <p>ART.(15620) 195851</p> <p>TIPKA ZA VODOKOTLIĆ JOG APLITE ECO <b>DUO</b> SJAJNI KROM</p> <p>ART.(15681) 195870</p> <p>TIPKA ZA VODOKOTLIĆ JOG APLITE ECO <b>DUO</b> MAT KROM</p> <p>ART.(15670) 195866</p>       |
|  | <p><b>0513025</b></p>                                             | <p>TIPKA ZA VODOKOTLIĆ JOG APLITE <b>STOP</b> BIJELA</p> <p>ART.(15621) 195852</p>                                                                                                                                                                                             |
|  | <p><b>0514033</b></p>                                             | <p>PRIKLJUČNA CIJEV 90x260 ZA UGRADNE VODOKOTLIĆE</p> <p>ART.195809</p>                                                                                                                                                                                                        |
|  | <p><b>0514036</b></p>                                             | <p>PRIKLJUČNA CIJEV Ø 44 ZA UGRADNE VODOKOTLIĆE SET</p> <p>ART.195278</p>                                                                                                                                                                                                      |



|  |                                                                                                     |                                                                                                                                                                                           |
|--|-----------------------------------------------------------------------------------------------------|-------------------------------------------------------------------------------------------------------------------------------------------------------------------------------------------|
|  | <p><b>05412</b></p> <p><b>05422</b></p> <p><b>05423</b></p> <p><b>05721</b></p> <p><b>05402</b></p> | <p><b>FONTANA</b></p> <p>FONTANA BIJELA ART.A60900</p> <p>FONTANA BEŽ ART.136.204.10.1</p> <p>FONTANA BERMUDA ART.136.204.BK.1</p> <p>FONTANA CALIPSO</p> <p>FONTANA SIVO - MANHATTAN</p> |
|  | <p><b>05731</b></p> <p><b>90088</b></p> <p><b>90089</b></p>                                         | <p><b>MONTANA DUO</b></p> <p>MONTANA DUO BIJELA ART.A60907</p> <p>MONTANA DUO BEŽ ART.136.504.10.1</p> <p>MONTANA DUO BERMUDA ART.136.504.BK.1</p>                                        |
|  | <p><b>0439032</b></p>                                                                               | <p><b>AP 116</b></p> <p>VODOKOTLIČ N/M AP 116 ART.A6098</p>                                                                                                                               |
|  | <p><b>05758</b></p>                                                                                 | <p><b>RIO</b></p> <p>RIO N.M BIJELI ART.A60902</p>                                                                                                                                        |



|  |                     |                                                                   |
|--|---------------------|-------------------------------------------------------------------|
|  | <p><b>22031</b></p> | <p><b>ANGOLO</b></p> <p>VODOKOTLIČ ANGOLO N/M BIJELO ART.1050</p> |
|--|---------------------|-------------------------------------------------------------------|





|                                                                                     |                |                                                        |
|-------------------------------------------------------------------------------------|----------------|--------------------------------------------------------|
|    | <b>1166001</b> | VISOKO I NISKO MONTAŽNI VODOKOTLIČ SATURN<br>ART.65799 |
|    | <b>1166002</b> | NISKO MONTAŽNI VODOKOTLIČ MERKUR<br>ART.68453          |
|  | <b>1166003</b> | UNIVERZALNI VENTIL ZA PVC VODOKOTLIČE<br>ART.62597     |
|  | <b>1166004</b> | WC ČETKA SET - ČAŠICA Ø13 cm, h=40 cm<br>ART.42        |
|  | <b>1166005</b> | WC ČETKA SET - VISEĆI Ø14 cm, h=40 cm<br>ART.332       |







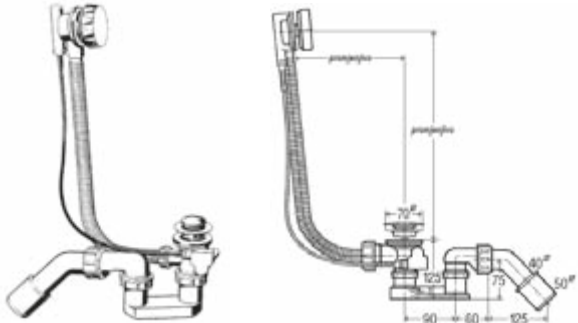
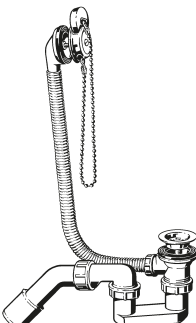
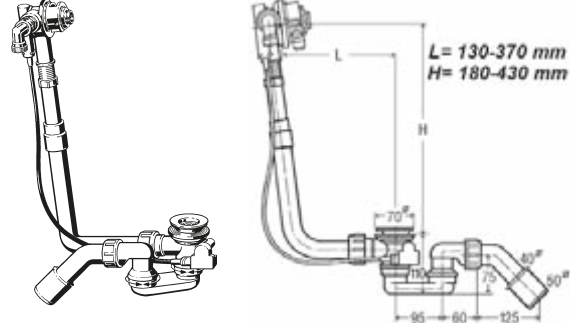
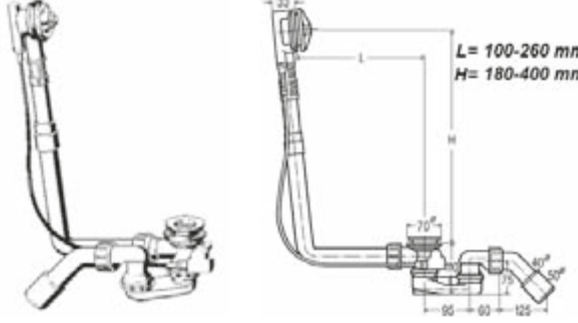
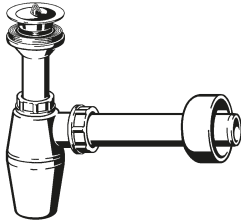
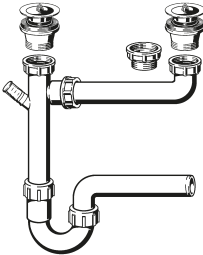
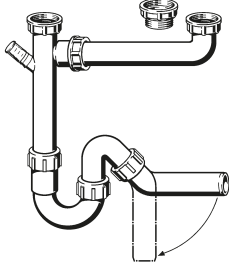
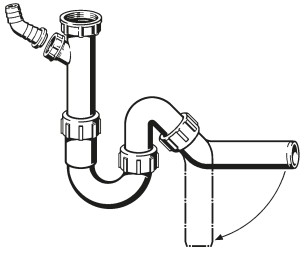
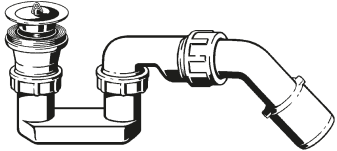



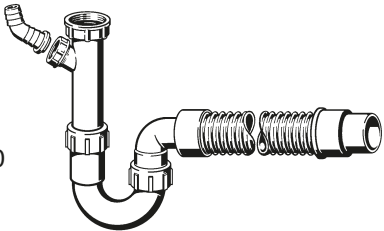
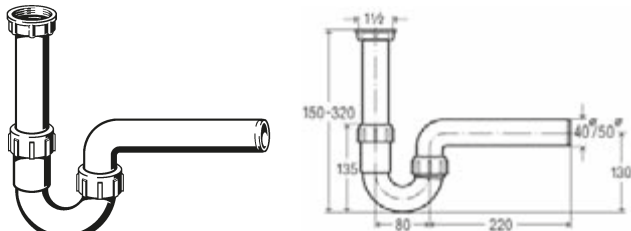

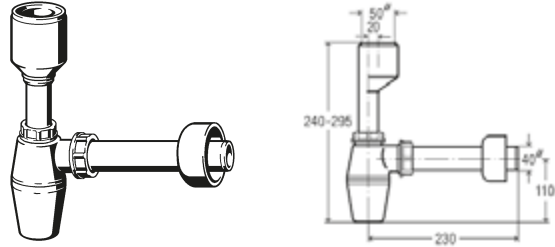

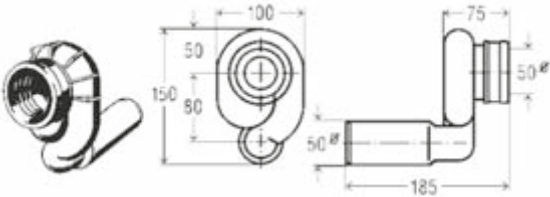
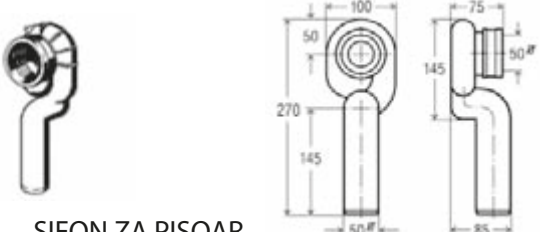

**Viega tehnika odvodnje  
za kupaonice i podove.**

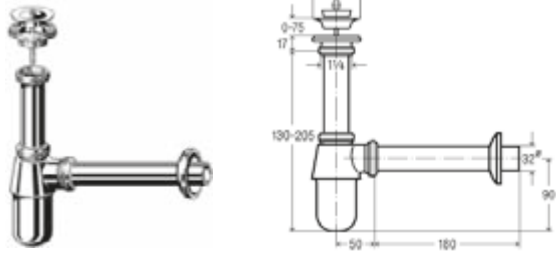

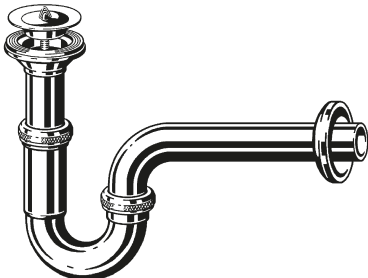
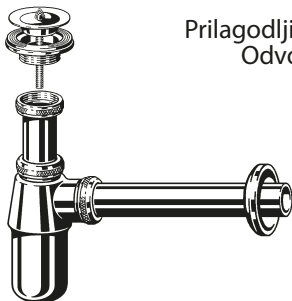
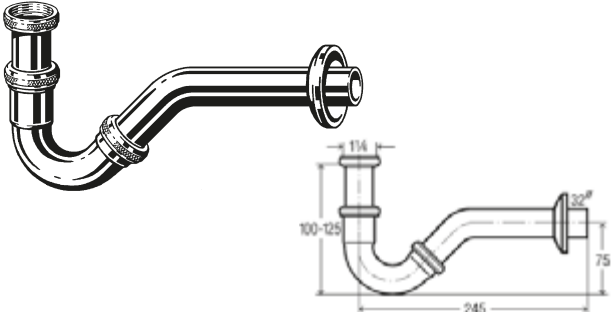
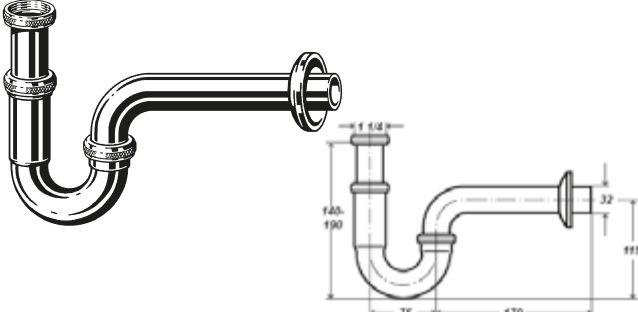

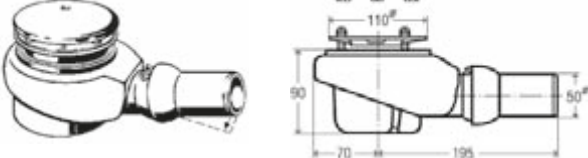

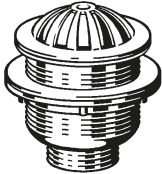
**viega**





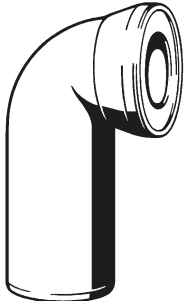

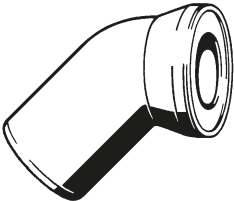
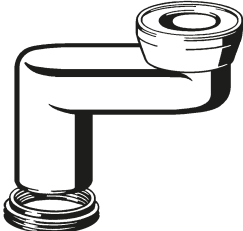

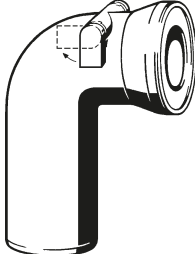
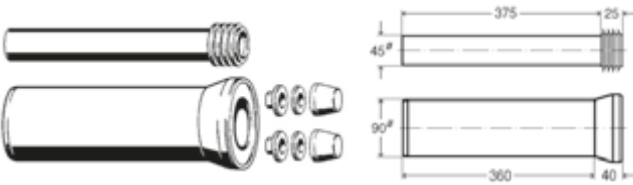
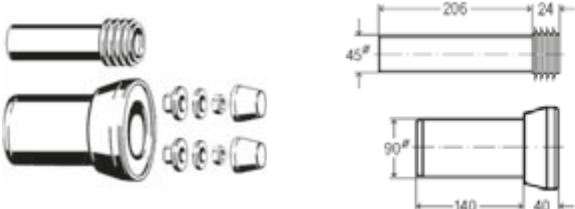

|                                                                                                                                                                                                                                           |                                                                                                                                                                                                                             |
|-------------------------------------------------------------------------------------------------------------------------------------------------------------------------------------------------------------------------------------------|-----------------------------------------------------------------------------------------------------------------------------------------------------------------------------------------------------------------------------|
|  <p><b>40002</b> SIFON ZA KADU<br/>HIDRAULIČNI VIEGA ART.285357</p> <p><b>40574</b> SIFON ZA KADU AUTOMATSKI S PRODUŽENIM IZLJEVOM 40x725 ART.595678</p> |  <p>Ovodni luk 45°</p> <p><b>40001</b> SIFON ZA KADU<br/>STANDARD VIEGA ART.311537</p>                                                   |
|  <p><b>40628</b> SPECIJALNI SIFON<br/>S DOVODOM I ODVODOM ART.300029</p> <p>L = 130-370 mm<br/>H = 180-430 mm</p>                                       |  <p><b>40300</b> SIFON ZA KADU<br/>PVC VIEGA ART.103071</p> <p>L = 100-260 mm<br/>H = 180-400 mm</p>                                     |
|  <p><b>40008</b> SIFON ZA UMIVAONIK<br/>PVC VIEGA ART.103927</p> <p>155-215<br/>114<br/>0-50<br/>40 185 100 32</p>                                     |  <p>G 1 1/2"<br/>DN 40, Ø70<br/>RAZMAK 90-310 mm</p> <p><b>42387</b> SIFON DVODJELNI S PRIKLJUČKOM<br/>I PILETAMA VIEGA ART.365875</p> |
|  <p>G 1 1/2"<br/>DN 40/50</p> <p><b>40011</b> SIFON DVODJELNI S PRIKLJUČKOM<br/>BEZ PILETE VIEGA ART.109585</p>                                        |  <p>G 1 1/2"<br/>DN 40/50</p> <p><b>40012</b> SIFON JEDNODJELNI S PRIKLJUČKOM<br/>BEZ PILETE VIEGA ART.101800</p>                      |
|  <p>G 1 1/2"<br/>DN 40/50<br/>Ø70</p> <p><b>40003</b> SIFON ZA TUŠ KADU<br/>VIEGA ART.312138</p>                                                       |  <p><b>0510084</b> SIFON ZA NADŽBUKNU<br/>UGRADNJU PVC 5/4x32 ART.570323</p> <p>80 140 55 100 110 32 118 40 50</p>                      |

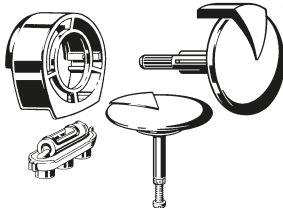
|                                                                                                                                                                                                                          |                                                                                                                                                                                                                                                 |
|--------------------------------------------------------------------------------------------------------------------------------------------------------------------------------------------------------------------------|-------------------------------------------------------------------------------------------------------------------------------------------------------------------------------------------------------------------------------------------------|
|  <p>G 1 1/2"<br/>DN 40/50<br/>L=500</p> <p><b>40158</b> SIFON JEDNODJELNI FLEKSIBILNI S PRIKLJUČKOM 6/4" 40x50 VIEGA<br/>ART.101633</p> |  <p><b>40013</b> SIFON JEDNODJELNI BEZ PILETE VIEGA<br/>ART.105716</p>                                                                                        |
|  <p>G 1 1/2"<br/>Ø70</p> <p><b>40014</b> PILETA PVC ZA SIFONE 6/4" VIEGA<br/>ART.102678</p>                                             |  <p><b>40004</b> SIFON ZA PISOAR VIEGA<br/>ART.112271</p>                                                                                                     |
|  <p>DN1 - 40<br/>DN2 - 50</p> <p><b>42149</b> SIFON ZA PISOAR VERTIKALNI<br/>ART.109271</p>                                            |  <p>DN1 - 40<br/>DN2 - 50</p> <p><b>42390</b> SIFON ZA PISOAR HORIZONTALNI<br/>ART.104993</p>                                                               |
|  <p><b>40976</b> SIFON ZA PISOAR HORIZONTALNI<br/>ART.492465</p>                                                                      |  <p><b>0510129</b> SIFON ZA PISOAR VERTIKALNI<br/>ART.492458</p>                                                                                            |
|  <p><b>0510128</b> NAVOJNA SPOJNICA 90°<br/>ART.102999</p>                                                                            |  <p>Prilagodljiva cijev 200 mm<br/>Odvodna cijev 310 mm<br/>Rozeta Ø32 x Ø80 x H 15 mm</p> <p><b>40696</b> SIFON ZA UMIVAONIK BEZ PILETE<br/>ART.440190</p> |
|  <p><b>0510079</b> SIFON ZA UMIVAONIK ELEGANTA SA KUTNIM VENTILIMA<br/>ART.490614</p>                                                 |  <p><b>0510119</b> SIFON ZA UMIVAONIK CROM S UNIVERZALNOM PILETOM VIEGA<br/>ART.456580</p>                                                                  |

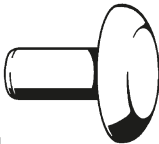
|                                                                                                                                                                                                                                           |                                                                                                                                                                                                                                       |
|-------------------------------------------------------------------------------------------------------------------------------------------------------------------------------------------------------------------------------------------|---------------------------------------------------------------------------------------------------------------------------------------------------------------------------------------------------------------------------------------|
|  <p><b>40287</b> SIFON ZA UMIVAONIK NIKLOVANI<br/>"S" 5/4" VIEGA ART.111298</p>                                                                          |  <p>Prilagodljiva cijev 103 mm<br/>Ovodni luk 170 mm</p> <p><b>42385</b> SIFON ZA UMIVAONIK CROM S UNIVERZAL-<br/>NOM PILETOM VIEGA ART.366681</p> |
|  <p><b>40289</b> SIFON ZA BIDE 5/4"<br/>DONJI DIO VIEGA ART.103781</p>                                                                                  |  <p><b>40288</b> DONJI DIO SIFONA ZA UMIVAONIK<br/>NIKLOVANI "S" 5/4" VIEGA ART.305611</p>                                                         |
|  <p><b>40657</b> SIFONSKA CIJEV Ø 32<br/>S OZRAKOM ART.117764</p>                                                                                      |  <p><b>0510086</b> ISPUSNA GARNITURA<br/>TERMOPLEX PLUS ART.578916</p>                                                                            |
|  <p><b>40301</b> PRODUŽNA CIJEV ZA SIFON<br/>32x250 mm VIEGA ART.101480</p> <p><b>40302</b> PRODUŽNA CIJEV ZA SIFON<br/>32x300 mm VIEGA ART.102203</p> |  <p><b>40306</b> SIFON BEZ PILETE VIEGA ART.136260</p>                                                                                           |
|  <p><b>40305</b> VENTIL ISPUSNI ZA PISOAR ART.144609</p>                                                                                               |  <p><b>0510108</b> UNIVERZALNI VENTIL/PILETA ART.111847</p>                                                                                       |

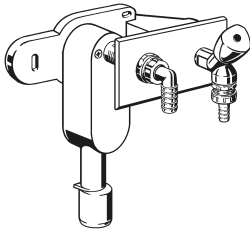
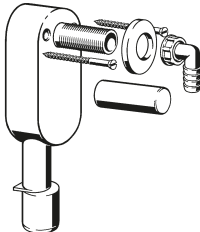

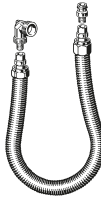

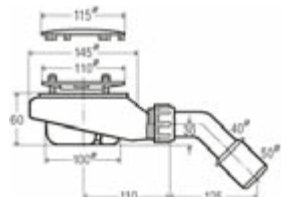
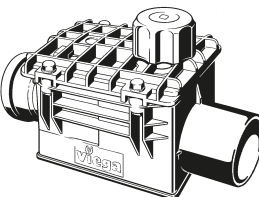
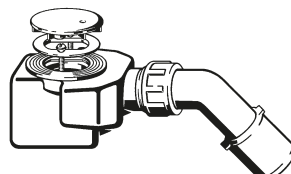



|                                                                                                                                                                                                                                                                      |                                                                                                                                                             |
|----------------------------------------------------------------------------------------------------------------------------------------------------------------------------------------------------------------------------------------------------------------------|-------------------------------------------------------------------------------------------------------------------------------------------------------------|
|  <p><b>40781</b> WC PRIKLJUČAK RAVNI<br/>Ø 110/40 cm VIEGA<br/>ART.101831</p> <p><b>40007</b> WC PRIKLJUČAK RAVNI<br/>Ø 110/25 cm VIEGA<br/>ART.101312</p>                          |  <p><b>40005</b> WC PRIKLJUČAK<br/>Ø 110/230 VIEGA<br/>ART.100551</p>    |
|  <p><b>40010</b> WC PRIKLJUČAK<br/>EKSCENTRIČNI VIEGA<br/>ART.103231</p>                                                                                                            |  <p><b>40006</b> WC PRIKLJUČAK 45<br/>Ø 110/135 VIEGA<br/>ART.101718</p> |
|  <p><b>0510065</b> WC PRIKLJUČAK EKSCENTRIČNI VIEGA<br/>EKSCENTAR 6 cm<br/>ART.484361</p> <p><b>40662</b> WC PRIKLJUČAK EKSCENTRIČNI VIEGA<br/>EKSCENTAR 12 cm<br/>ART.340780</p> |  <p><b>40655</b> PRIKLJUČAK ZA WC<br/>ART.296032</p>                   |
|  <p><b>40664</b> WC PRIKLJUČAK<br/>S Klapnom RAVNI<br/>ART.134969</p>                                                                                                             |  <p><b>40663</b> WC PRIKLJUČAK 90<br/>S Klapnom<br/>ART.138882</p>     |
|  <p><b>0510099</b> PRIKLJUČNA GARNITURA<br/>ZA WC DN90x400<br/>ART.654474</p>                                                                                                     |  <p><b>0520022</b> WC PRIKLJUČAK DN90<br/>ART.263812</p>                |

|                                                                                                                                                                                                                                                                      |                                                                                                                                                                                                                                                                                                            |
|----------------------------------------------------------------------------------------------------------------------------------------------------------------------------------------------------------------------------------------------------------------------|------------------------------------------------------------------------------------------------------------------------------------------------------------------------------------------------------------------------------------------------------------------------------------------------------------|
| <br><b>40517</b> ROZETA ZA WC PRIKLJUČAK Ø 110 VIEGA ART.101343                                                                                                                     | <br><b>40299</b> ROZETA ZA WC PRIKLJUČAK Ø 110 VIEGA ART.101671                                                                                                                                                         |
| <br><b>40629</b> NIKLOVANI SET ZA SIFON KADE "MULTIPLEX TRIO" ART.306847                                                                                                            | <br><b>40015</b> KOMPLET GUMA ZA SIFONE VIEGA ART.122782                                                                                                                                                                |
| <br><b>40658</b> ČEP BIJELI ZA SIFONSKE ISPUSTE ART.120603<br><b>40659</b> ČEP NIKLOVANI ZA SIFONSKE ISPUSTE ART.112547                                                             |  40979<br> 40660<br><b>40979</b> ROZETA ZA SIFONE 32x80x24 KROMIRANA ART.110628<br><b>40660</b> ROZETA ZA SIFONE NIKLOVANA ART.111380 |
| <br><b>40643</b> SIFON S PRIKLJUČKOM UNIVERZALNI ZA PERILICU 40/50 mod.56351 ART.369156                                                                                            | <br><b>42386</b> SIFON ZA PERILICU VIEGA ART.370756                                                                                                                                                                    |
| <br><b>40959</b> PRODUŽNI KOMAD ZA SIFON PERILICE 5 cm NAVOJ 1" ART.131623                                                                                                        | <br><b>40970</b> ELEMENT ZA PODEŠAVANJE VISINE SIFONA mod.4947 ART.111496                                                                                                                                             |
| <br><b>40630</b> PRIKLJUČNA CIJEV SIFONA ZA DOVOD VODE ART.106010                                                                                                                 |  <br><b>0510133</b> SIFON ZA TUŠ KADU NISKA IZVEDBA ART.634100                                                                    |
| <br><b>40304</b> OSIGURAČ ZA PRELAZNE VODE Ø 110 ART.136192<br><b>40414</b> OSIGURAČ ZA PRELAZNE VODE Ø 125 ART.154073<br><b>40415</b> OSIGURAČ ZA PRELAZNE VODE Ø 150 ART.150792 | <br><b>42389</b> SIFON ZA TUŠ KADU Ø 65 VIEGA ART.208615<br><b>0510077</b> SIFON ZA TUŠ KADU Ø52 VIEGA ART.126582<br><b>40780</b> SIFON ZA TUŠ KADU Ø 90 VIEGA ART.364786                                             |

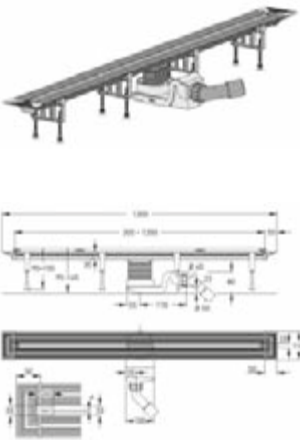
## Kupaonički i podni odvodi Advantix, protupožarna zaštita, zvučna izolacija

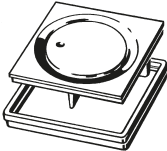

|                                                                                     |                |                                                                    |            |
|-------------------------------------------------------------------------------------|----------------|--------------------------------------------------------------------|------------|
|    | <b>40652</b>   | SLIVNIK SPECIJALNI ZA KUPATILO                                     | ART.556921 |
|    | <b>40790</b>   | SLIVNIK PODNI Ø 70 mod.49551                                       | ART.557164 |
|                                                                                     | <b>40791</b>   | SLIVNIK PODNI Ø 100 mod.49551                                      | ART.557171 |
|                                                                                     | <b>40653</b>   | SLIVNIK SPECIJALNI ZA TERASU Ø50                                   | ART.557072 |
|   | <b>40943</b>   | SLIVNIK PODNI Ø 50 mod.49511                                       | ART.557188 |
|                                                                                     | <b>40944</b>   | SLIVNIK PODNI Ø 70 mod.49511                                       | ART.557195 |
|                                                                                     | <b>40787</b>   | SLIVNIK PODNI Ø 100 mod.49511                                      | ART.557201 |
|  | <b>0510082</b> | PODNI SLIVNIK DN50 ZA KUPATILO SA SIGURNOSNIM ZAPOROM MIRISA VIEGA | ART.583217 |
|  | <b>40950</b>   | PODNI SLIVNIK DN50 ZA KUPATILO VIEGA                               | ART.557119 |
|  | <b>40776</b>   | SLIVNIK ZA TERASU SA IZOLACIJSKOM PRIRUBNICOM                      | ART.363031 |
|  | <b>0510083</b> | OBORINSKI ODVOD SA NASTAVKOM DN 100 VIEGA                          | ART.586744 |
|  | <b>40303</b>   | SLIVNIK Ø 50 PLITKI VIEGA                                          | ART.125936 |

|                                                                                     |                |                                                              |            |
|-------------------------------------------------------------------------------------|----------------|--------------------------------------------------------------|------------|
|    | <b>0510102</b> | TUŠ KANALICA ADVANTIX VARIO l=300-1200mm                     | ART.686277 |
|    | <b>0510103</b> | REŠETKA ZA KANALICU MAT VISIGN<br>SR1 L=300-1200mm           | ART.686284 |
|   | <b>0510104</b> | REŠETKA ZA KANALICU SJAJNA VISIGN<br>SR2 L=300-1200mm        | ART.686291 |
|  | <b>0510130</b> | ADVANTIX ODVOD ZA BALKONE I TERASE DN 50 VIEGA               | ART.289393 |
|                                                                                     | <b>0510114</b> | ADVANTIX ODVOD ZA BALKONE I TERASE DN 70 VIEGA               | ART.289409 |
|                                                                                     | <b>0510131</b> | ADVANTIX ODVOD ZA BALKONE I TERASE DN 100 VIEGA              | ART.626990 |
|  | <b>0510132</b> | ADVANTIX ODVOD ZA BALKONE I TERASE<br>VERTIKALNI DN 50 VIEGA | ART.125158 |
|  | <b>40777</b>   | REŠETKA ZA SLIVNIK PVC/KROM                                  | ART.446086 |
|  | <b>0510074</b> | REŠETKA OD PLEMENITOG ČELIKA RS2 94x94 mm VIEGA              | ART.492298 |
|  | <b>0510080</b> | NASADNIK - SA OKVIROM OD PLEMENITOG ČELIKA VIEGA             | ART.488987 |



|                                                                                     |                |                                                                |            |
|-------------------------------------------------------------------------------------|----------------|----------------------------------------------------------------|------------|
|    | <b>0510078</b> | NASTAVAK ZA SLIVNIKE S REŠETKOM<br>OD PLEMENITOG ČELIKA        | ART.555177 |
|    | <b>40963</b>   | REŠETKA ZA SLIVNIK                                             | ART.144012 |
|   | <b>40783</b>   | KAPA NIKLOVANA ZA UGRADBENE ELEMENTE                           | ART.107505 |
|  | <b>40961</b>   | EPDM TRAKA ZA BRTVLJENJE Ø 50<br>(ZA IZOLACIJU TERASA)         | ART.125530 |
|  | <b>40960</b>   | EPDM TRAKA ZA BRTVLJENJE Ø 75 i Ø 110<br>(ZA IZOLACIJU TERASA) | ART.287924 |

|                                                                                       |                                                                                 |
|---------------------------------------------------------------------------------------|---------------------------------------------------------------------------------|
| <p><b>03025</b><br/>SIFON ZA UMIVAONIK<br/>ART.196617</p>                             | <p><b>03011</b><br/>SIFON ZA TUŠ KADU - LIV<br/>ART.196028</p>                  |
| <p><b>03027</b><br/>SIFON ZA SUDOPER<br/>JEDNODJELNI S PRIKLJUČKOM<br/>ART.196976</p> | <p><b>03028</b><br/>SIFON ZA SUDOPER JEDNODJELNI<br/>ART.196974</p>             |
| <p><b>03030</b><br/>SIFON ZA SUDOPER DVODJELNI<br/>ART.196975</p>                     | <p><b>03026</b><br/>SIFON ZA SUDOPER JEDNODJELNI S PRELJEVOM<br/>ART.195334</p> |
| <p><b>03031</b><br/>SIFON ZA KADU "AUTOMATIK"<br/>H=650 mm<br/>ART.196915</p>         | <p><b>03013</b><br/>SIFON ZA KADU H=650 mm<br/>ART.196504</p>                   |
| <p><b>03029</b><br/>SIFON ZA SUDOPER DVODJELNI S PRELJEVOM<br/>ART.195346</p>         | <p><b>03007</b><br/>CIJEV ZA NISKU MONTAŽU<br/>ART.195774</p>                   |

|  |                |                                            |                       |
|--|----------------|--------------------------------------------|-----------------------|
|  | <b>0514026</b> | JEDNODJELNI SIFON S PRIKLJUČKOM            | ART.(14192)<br>195558 |
|  | <b>0514025</b> | JEDNODJELNI SIFON S PRIKLJUČKOM            | ART.(48154)<br>196492 |
|  | <b>0514024</b> | DVODJELNI SIFON S PRIKLJUČKOM              | ART.(14201)<br>195559 |
|  | <b>0514023</b> | DVODJELNI SIFON S PRIKLJUČKOM              | ART.(11551)<br>195284 |
|  | <b>0514028</b> | PODNI SIFON S REŠETKOM                     | ART.(11110)<br>195246 |
|  | <b>0514027</b> | PRODUŽETAK SIFONA                          | ART.(49596)<br>196765 |
|  | <b>03009</b>   | BRTVA ZA ISPIRNU CIJEV Ø 40<br>VODOKOTLIČA | ART.(50190)<br>196907 |

**03016**

SIFON ZA PERILICU PODŽBUKNI  
ART.(12821) 195546

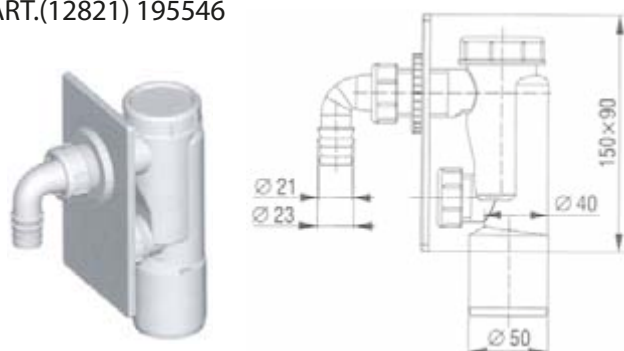

**03014**

CIJEVNI NASTAVAK Ø 40  
ART.(17189) 195997



**03012**

BRTVA ZA ODOČNI VENTIL LAGUNA  
ART.(50192) 196909

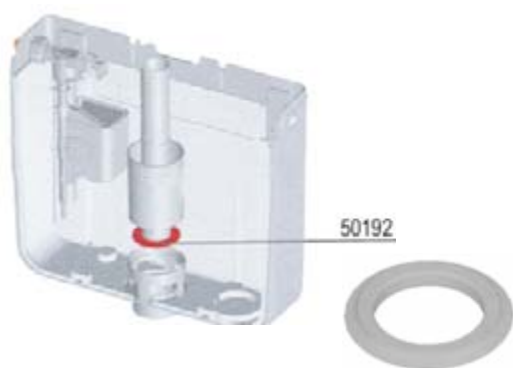

**03006**

CIJEV ZA VISOKU MONTAŽU  
ART.(50202) 196911

840 g  
30/kućija (350 x 350 x 1750 mm)

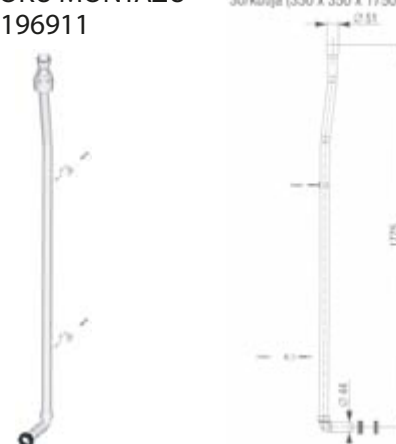

**0514021**

PLOVAK ZA VODOKOTLIĆ  
ART.(15932) 195933

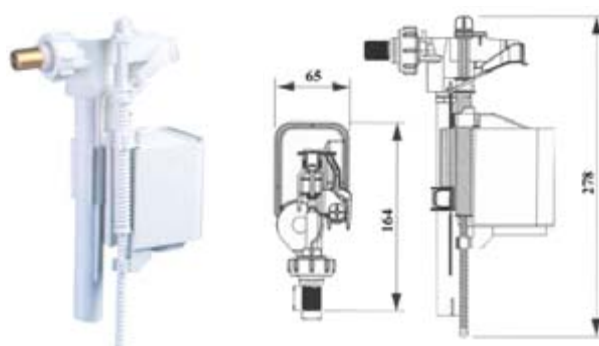

**0514022**

ODSISAČ ZA VODOKOTLIĆ TORNADO  
ART.(11531) 195280

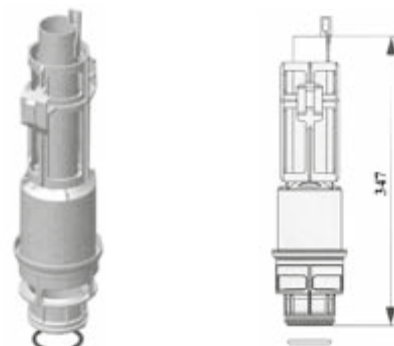

**0514020**



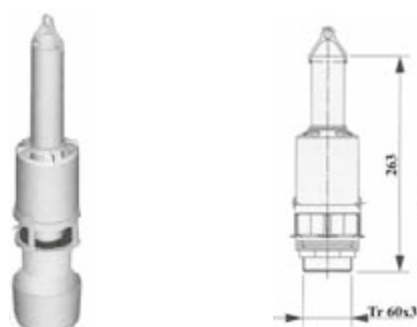





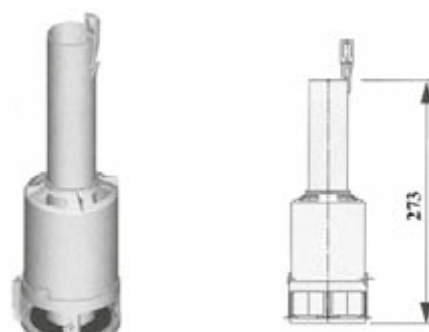

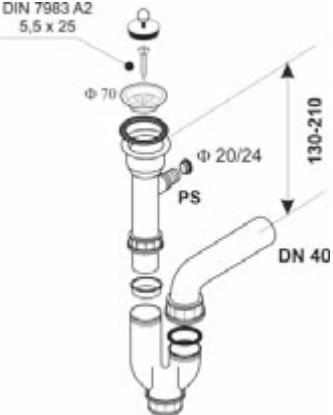

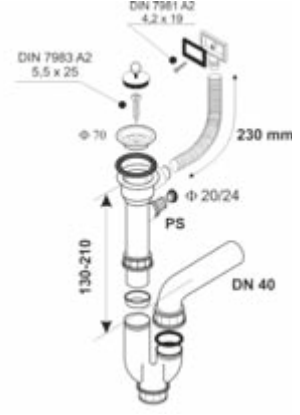

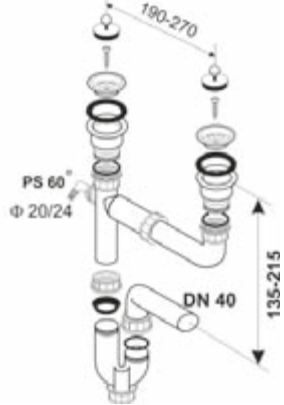
ODSISAČ ZA VODOKOTLIĆ CIKLON  
ART.(62388) 197003

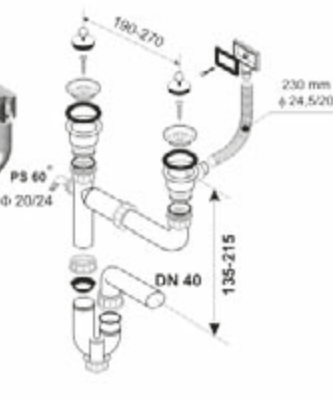

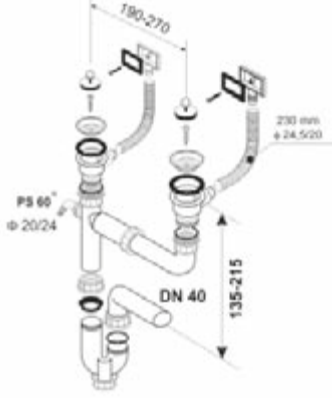

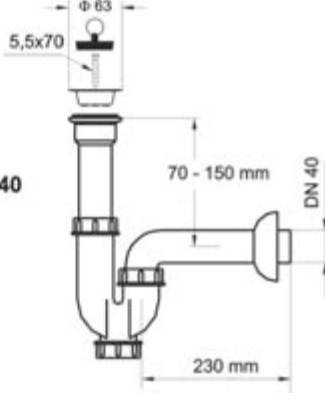
**0514019**

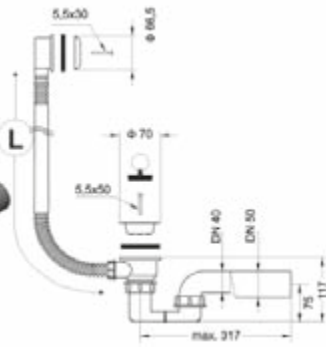

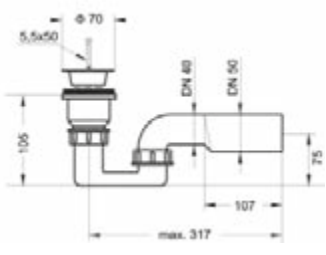

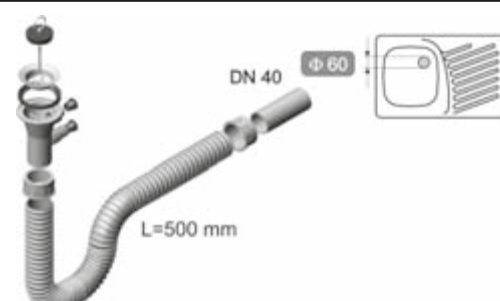
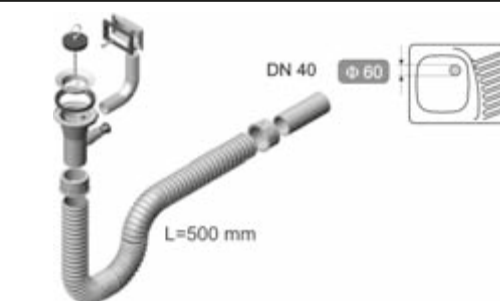
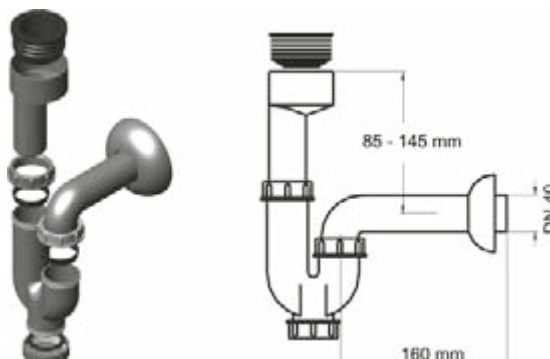
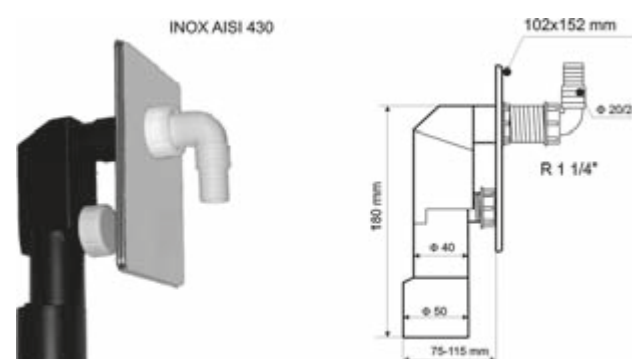
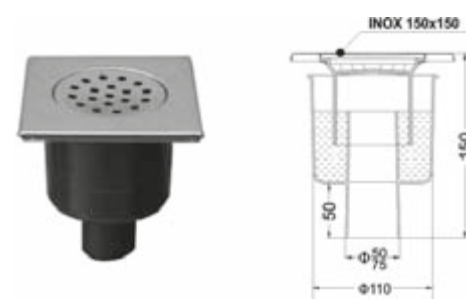
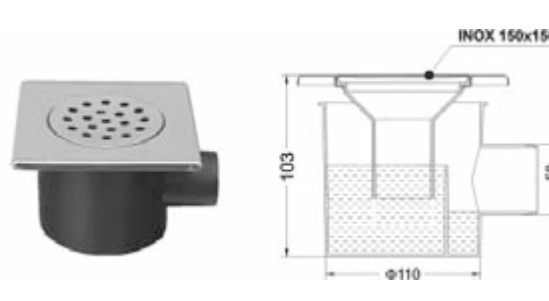
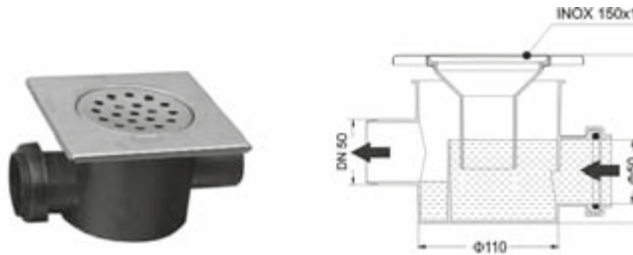

ODSISAČ ZA VODOKOTLIĆ VISION  
ART.(11162) 195256

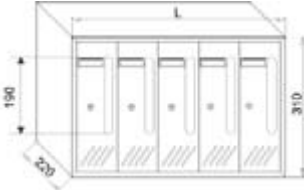

|                                                                                                                                                                                                                                                                                                           |                                                                                                                                                                                                                                                         |
|-----------------------------------------------------------------------------------------------------------------------------------------------------------------------------------------------------------------------------------------------------------------------------------------------------------|---------------------------------------------------------------------------------------------------------------------------------------------------------------------------------------------------------------------------------------------------------|
|   <p><b>37005</b> SIFON JEDNODJELNI<br/>S PRIKLUČ. /O</p> <p>ART.30231</p>                                                              |   <p><b>37030</b> SIFON JEDNODJELNI<br/>S PRIKLJ. PRELJEV. /O</p> <p>ART.30234</p> |
|   <p><b>37008</b> SIFON DVODJELNI<br/>S PRIKLUČ. /O</p> <p>ART.30239</p>                                                              |   <p><b>37009</b> SIFON DVODJELNI<br/>S PRIKLJ. I 1 PRELJ.</p> <p>ART.30240</p>  |
|   <p><b>37010</b> SIFON DVODJELNI<br/>S PRIKLJ. I 2 PRELJ.</p> <p>ART.30243</p>                                                     |   <p><b>10009</b> SIFON ZA UMIVAONIK</p> <p>ART.30172</p>                      |
|   <p><b>10006</b> SIFON ZA KADU h=450</p> <p><b>37038</b> SIFON ZA KADU S PRELJEVOM<br/>h=750</p> <p>ART.30544</p> <p>ART.31172</p> |   <p><b>37012</b> SIFON ZA TUŠ KADU</p> <p>ART.30545</p>                       |

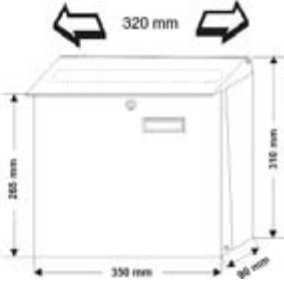

|  <p><b>0511028</b> SIFON JEDNODJELNI ZA SUDOPER ART.31648</p>                                                                                                                                                                                                                                                           |  <p><b>0511026</b> SIFON JEDNODJELNI S PRELJEVOM ZA SUDOPER FLEKSIBILNI ART.31633</p>                                              |         |         |         |         |         |       |       |       |       |       |       |                                                                                                                                                                                                                                                       |
|----------------------------------------------------------------------------------------------------------------------------------------------------------------------------------------------------------------------------------------------------------------------------------------------------------------------------------------------------------------------------------------------------------|----------------------------------------------------------------------------------------------------------------------------------------------------------------------------------------------------------------------|---------|---------|---------|---------|---------|-------|-------|-------|-------|-------|-------|-------------------------------------------------------------------------------------------------------------------------------------------------------------------------------------------------------------------------------------------------------|
|  <p><b>10010</b> SIFON ZA PISOAR ART.30179</p>                                                                                                                                                                                                                                                                          |  <p><b>0511024</b> SIFON ZA PERILICU ART.31604</p>                                                                            |         |         |         |         |         |       |       |       |       |       |       |                                                                                                                                                                                                                                                       |
|  <p><b>37001</b> SIFON VERTIK. Ø 50 S NIKL. REŠETKOM ART.30167<br/> <b>37002</b> SIFON VERTIK. Ø 75 S NIKL. REŠETKOM ART.30168</p>                                                                                                                                                                                    |  <p><b>37037</b> SIFON HORIZ. Ø 75 S NIKL. REŠETKOM ART.30170<br/> <b>37003</b> SIFON HORIZ. Ø 50 S NIKL. REŠETKOM ART.30169</p> |         |         |         |         |         |       |       |       |       |       |       |                                                                                                                                                                                                                                                       |
|  <p><b>10012</b> SIFON PODNI Ø 50 S PRIKLJUČKOM ART.30171</p>                                                                                                                                                                                                                                                         |  <p><b>14060</b> REŠETKA S TULJKOM ART.30595</p>                                                                                 |         |         |         |         |         |       |       |       |       |       |       |                                                                                                                                                                                                                                                       |
|  <table border="1" data-bbox="165 2066 826 2135"> <thead> <tr> <th>A x B (mm)</th> <th>150x150</th> <th>200x200</th> <th>200x250</th> <th>250x250</th> <th>300x300</th> </tr> </thead> <tbody> <tr> <td>IDENT</td> <td>31260</td> <td>31261</td> <td>31171</td> <td>31085</td> <td>31146</td> </tr> </tbody> </table> | A x B (mm)                                                                                                                                                                                                           | 150x150 | 200x200 | 200x250 | 250x250 | 300x300 | IDENT | 31260 | 31261 | 31171 | 31085 | 31146 | <p><b>12009</b> VRATAŠČA ZA KADU NIKLOVANA 15x15 ART.31260<br/> <b>12010</b> VRATAŠČA ZA KADU NIKLOVANA 20x20 ART.31261<br/> <b>09089</b> VRATAŠČA ZA KADU NIKLOVANA 20x25 ART.31171<br/> <b>37021</b> VRATAŠČA ZA KADU NIKLOVANA 30x30 ART.31146</p> |
| A x B (mm)                                                                                                                                                                                                                                                                                                                                                                                               | 150x150                                                                                                                                                                                                              | 200x200 | 200x250 | 250x250 | 300x300 |         |       |       |       |       |       |       |                                                                                                                                                                                                                                                       |
| IDENT                                                                                                                                                                                                                                                                                                                                                                                                    | 31260                                                                                                                                                                                                                | 31261   | 31171   | 31085   | 31146   |         |       |       |       |       |       |       |                                                                                                                                                                                                                                                       |

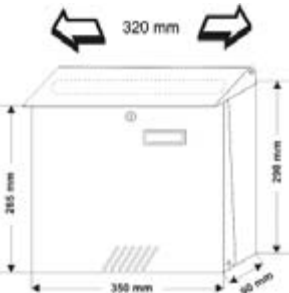
| <br><br><p>Tablica dimenzija/Table with dimensions</p> <table border="1" data-bbox="517 626 745 753"> <thead> <tr> <th>Tip/Type:</th> <th>Šifra/Code:</th> <th>L (mm)</th> </tr> </thead> <tbody> <tr> <td>3/1</td> <td>31149</td> <td>292</td> </tr> <tr> <td>4/1</td> <td>31131</td> <td>382</td> </tr> <tr> <td>5/1</td> <td>31132</td> <td>472</td> </tr> <tr> <td>6/1</td> <td>31133</td> <td>562</td> </tr> </tbody> </table> | Tip/Type:                                                            | Šifra/Code:      | L (mm) | 3/1 | 31149 | 292 | 4/1 | 31131 | 382 | 5/1 | 31132 | 472 | 6/1 | 31133 | 562 | <p><b>37048</b> POŠTANSKI ORMARIĆ<br/>U NIZU - BOX 3/1<br/>METALIK SIVO</p> <p><b>37049</b> POŠTANSKI ORMARIĆ<br/>U NIZU - BOX 4/1<br/>METALIK SIVO</p> <p><b>37050</b> POŠTANSKI ORMARIĆ<br/>U NIZU - BOX 5/1<br/>METALIK SIVO</p> <p><b>37051</b> POŠTANSKI ORMARIĆ<br/>U NIZU - BOX 6/1<br/>METALIK SIVO</p> | <p>ART.31149</p> <p>ART.31131</p> <p>ART.31132</p> <p>ART.31133</p> |
|-------------------------------------------------------------------------------------------------------------------------------------------------------------------------------------------------------------------------------------------------------------------------------------------------------------------------------------------------------------------------------------------------------------------------------------------------------------------------------------------------------------------------------------------------------------------------------------------------------|----------------------------------------------------------------------|------------------|--------|-----|-------|-----|-----|-------|-----|-----|-------|-----|-----|-------|-----|-----------------------------------------------------------------------------------------------------------------------------------------------------------------------------------------------------------------------------------------------------------------------------------------------------------------|---------------------------------------------------------------------|
| Tip/Type:                                                                                                                                                                                                                                                                                                                                                                                                                                                                                                                                                                                             | Šifra/Code:                                                          | L (mm)           |        |     |       |     |     |       |     |     |       |     |     |       |     |                                                                                                                                                                                                                                                                                                                 |                                                                     |
| 3/1                                                                                                                                                                                                                                                                                                                                                                                                                                                                                                                                                                                                   | 31149                                                                | 292              |        |     |       |     |     |       |     |     |       |     |     |       |     |                                                                                                                                                                                                                                                                                                                 |                                                                     |
| 4/1                                                                                                                                                                                                                                                                                                                                                                                                                                                                                                                                                                                                   | 31131                                                                | 382              |        |     |       |     |     |       |     |     |       |     |     |       |     |                                                                                                                                                                                                                                                                                                                 |                                                                     |
| 5/1                                                                                                                                                                                                                                                                                                                                                                                                                                                                                                                                                                                                   | 31132                                                                | 472              |        |     |       |     |     |       |     |     |       |     |     |       |     |                                                                                                                                                                                                                                                                                                                 |                                                                     |
| 6/1                                                                                                                                                                                                                                                                                                                                                                                                                                                                                                                                                                                                   | 31133                                                                | 562              |        |     |       |     |     |       |     |     |       |     |     |       |     |                                                                                                                                                                                                                                                                                                                 |                                                                     |
| <br>                                                                                                                                                                                                                                                                                                                                                                                                                              | <p><b>37019</b> POŠTANSKI ORMARIĆ<br/>METALIK SIVO</p>               | <p>ART.31005</p> |        |     |       |     |     |       |     |     |       |     |     |       |     |                                                                                                                                                                                                                                                                                                                 |                                                                     |
| <br>                                                                                                                                                                                                                                                                                                                                                                                                                            | <p><b>0512030</b> POŠTANSKI ORMARIĆ<br/>EXTRA VELIKI BIJELI</p>      | <p>ART.31734</p> |        |     |       |     |     |       |     |     |       |     |     |       |     |                                                                                                                                                                                                                                                                                                                 |                                                                     |
| <br>                                                                                                                                                                                                                                                                                                                                                                                                                            | <p><b>0512031</b> POŠTANSKI ORMARIĆ<br/>EXTRA VELIKI ALUMINIJSKI</p> | <p>ART.31554</p> |        |     |       |     |     |       |     |     |       |     |     |       |     |                                                                                                                                                                                                                                                                                                                 |                                                                     |

### SIFON GARNITURA ZA UMIVAONIK 1 1/4"

| Šifra<br>VOKEL | Boja | Broj<br>Artikla | Pakovanje<br>KOM |
|----------------|------|-----------------|------------------|
| 10016          | KROM | 16301           | 12               |

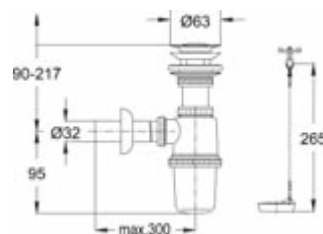

### SIFON ZA PISOAR 1 1/4"

| Šifra<br>VOKEL | Boja | Broj<br>Artikla | Pakovanje<br>KOM |
|----------------|------|-----------------|------------------|
| 10058          | KROM | 16204           | 12               |

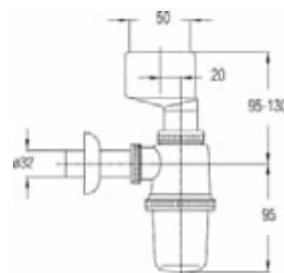

### SIFON ZA PERILICU

| Šifra<br>VOKEL | Boja | Broj<br>Artikla | Pakovanje<br>KOM |
|----------------|------|-----------------|------------------|
| 10011          | KROM | 16501           | 24               |

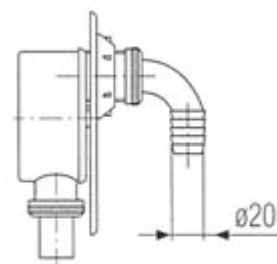

### SIFON GARNITURA ZA UMIVAONIK 1 1/4"

| Šifra<br>VOKEL | Boja | Broj<br>Artikla | Pakovanje<br>KOM |
|----------------|------|-----------------|------------------|
| 10086          | KROM | 16302           | 12               |

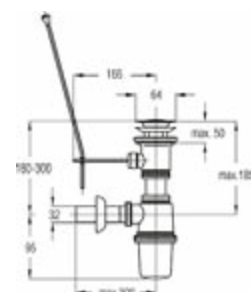

### SIFON GARNITURA ZA UMIVAONIK 1 1/4"

| Šifra<br>VOKEL | Boja | Broj<br>Artikla |
|----------------|------|-----------------|
| 02581          | KROM | 16305           |

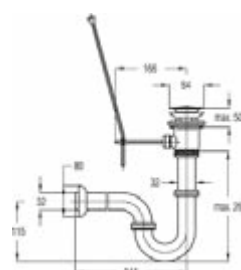

### SIFON GARNITURA ZA UMIVAONIK 1 1/4"

| Šifra<br>VOKEL | Boja | Broj<br>Artikla |
|----------------|------|-----------------|
| 0506012        | KROM | 16306           |

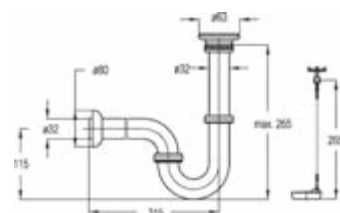

|                                                                                     |                |                                                                                                                  |         |
|-------------------------------------------------------------------------------------|----------------|------------------------------------------------------------------------------------------------------------------|---------|
|    | <b>0532001</b> | GORNJI DIO SIFONA ZA UMIVAONIK MESINGANI<br>1 1/4" GHIDINI                                                       | ART.465 |
|    | <b>0532002</b> | SIFON ZA UMIVAONIK MESINGANI 1 1/4" GHIDINI<br>(Izlazna cijev L=25cm, ulazna cijev L=12cm, rozeta D.75)          | ART.527 |
|   | <b>0532003</b> | SIFON ZA UMIVAONIK MESINGANI 1 1/4" GHIDINI<br>(Izlazna cijev L=25cm, ulazna cijev L=12cm, rozeta D.75)          | ART.529 |
|  | <b>0532004</b> | CJEVASTI SIFON MESINGANI 1 1/4" ZA UMIVAONIK GHIDINI<br>(Izlazna cijev L=25cm, ulazna cijev L=12cm, rozeta D.75) | ART.560 |
|  | <b>0532013</b> | SIFON ZA UMIVAONIK SOFIA GHIDINI 5/4"<br>(Izlazna cijev L=32mm, L-cijev dim 250x150 mm)                          | ART.488 |
|  | <b>0532005</b> | CJEVASTI SIFON MESINGANI 1 1/4" ZA BIDE GHIDINI<br>(Izlazna cijev L=25cm, ulazna cijev L=7,5cm, rozeta D.75)     | ART.563 |

|                                                                                                                          |                |                                                        |           |
|--------------------------------------------------------------------------------------------------------------------------|----------------|--------------------------------------------------------|-----------|
|                                         | <b>0532007</b> | ROZETA INOX D.32 GHIDINI                               | ART.839   |
|                                         | <b>0532006</b> | PRODUŽNA CIJEV S PRSTENOM ZA SIFONE GHIDINI D.32x13 cm | ART.841   |
|             | <b>0532009</b> | SPOJNICA ZA SIFON 1 1/4" S MATICOM GHIDINI             | ART.846   |
|  | <b>0532010</b> | INOX/MESINGANA SPOJNICA 1 1/4" S PRSTENIMA D32 GHIDINI | ART.846OR |
|                           | <b>0532014</b> | SPOJNICA 90° KROM 5/4" GHIDINI                         | ART.580   |
|      | <b>0532015</b> | SPOJNICA 90° KROM 5/4" S 2 PRSTENA GHIDINI             | ART.580S  |
|                                       | <b>0532011</b> | INOX/MESINGANA CIJEV D.32 20 cm GHIDINI                | ART.850   |
|                                                                                                                          | <b>0532012</b> | INOX/MESINGANA CIJEV D.32 25 cm GHIDINI                | ART.850   |
|                                                                                                                          | <b>0532008</b> | INOX/MESINGANA CIJEV D.32 30 cm GHIDINI                | ART.850   |



|                                                                                                                                                     |                                                                                                                                                    |
|-----------------------------------------------------------------------------------------------------------------------------------------------------|----------------------------------------------------------------------------------------------------------------------------------------------------|
| <br><b>22146 PLOVAK 3/8" S LOPTICOM</b> ART.1511 | <br><b>22144 WC PRIKLJUČAK Ø 110 RAVNI BIJELO</b> ART. 1641     |
| <br><b>22147 PLOVAK S DONJIM PRIKLJUČKOM 1/2"</b> ART.1515A        | <br><b>22145 WC PRIKLJUČAK Ø 110 EKSCENTRIČNI</b> ART.1641E     |
| <br><b>22016 PLOVAK 3/8" RAMBO</b> ART.1510             | <br><b>22027 SIFONSKA GUMA 48-51mm-32mm BIJELO</b> ART.1523    |
| <br><b>22156 PLOVAK BLACK RAMBO</b> ART.1512                     | <br><b>22025 SIFONSKA GUMA 48-51mm-40mm BIJELO</b> ART.1523A  |
| <br><b>22148 UNIVERZALNI PLOVAK 3/8"</b> ART.1510K               | <br><b>22014 SIFONSKA GUMA 55-58mm-32mm BIJELO</b> ART.1524   |
| <br><b>22052 ISPUSNI DIO ZA VODOKOTLIĆ</b> ART.1400 B            | <br><b>22041 SIFONSKA GUMA 55-58mm-40mm BIJELO</b> ART.1524 A |

|                                                                                                                                                                                                                    |                                                                                                                                                       |
|--------------------------------------------------------------------------------------------------------------------------------------------------------------------------------------------------------------------|-------------------------------------------------------------------------------------------------------------------------------------------------------|
|  <p><b>22011</b> SIFON VERTIKALNI<br/>150x150x50 PVC</p> <p>ART.1701</p>                                                          |  <p><b>22008</b> CIJEV FLEXIBILNA U ROLNI D 32</p> <p>ART.8000</p> |
|  <p><b>22012</b> SIFON VERTIKALNI<br/>200x200x75 PVC</p> <p>ART.1702</p>                                                          |                                                                                                                                                       |
|  <p><b>22013</b> SIFON VERTIKALNI<br/>250x250x110 PVC</p> <p>ART.1703</p>                                                        |  <p><b>22006</b> SPOJNICA PVC D 32</p> <p>ART.8005</p>            |
|  <p><b>22131</b> SIFON VERTIKALNI<br/>300x300x110 PVC</p> <p>ART.1704</p>                                                       |  <p><b>22149</b> SPOJNICA PVC Ø 40</p> <p>ART.8006</p>           |
|  <p><b>22150</b> PODNI SIFON<br/>S HORIZONTALNIM IZLAZOM 150x150/50</p> <p>ART.1706</p>                                         |  <p><b>22007</b> SPOJNICA PVC S MATICOM 5/4"</p> <p>ART.8008</p> |
|  <p><b>22050</b> PRIKLJUČAK SAVITLJIVI 6/4"</p> <p>ART.8058</p> <p><b>22051</b> PRIKLJUČAK SAVITLJIVI 5/4 "</p> <p>ART.8056</p> |  <p><b>22151</b> SPOJNICA PVC S MATICOM 6/4"</p> <p>ART.8009</p> |

|                                                                                     |                |                                                               |             |
|-------------------------------------------------------------------------------------|----------------|---------------------------------------------------------------|-------------|
|    | <b>90820</b>   | FLEXIBILNA CIJEV TEXOFLEX ZR Q 100                            | ART.001-376 |
|                                                                                     | <b>90821</b>   | FLEXIBILNA CIJEV TEXOFLEX ZR Q 110                            | ART.001-327 |
|                                                                                     | <b>90822</b>   | FLEXIBILNA CIJEV TEXOFLEX ZR Q 120                            | ART.001-328 |
|    | <b>90823</b>   | FLEXIBILNA CIJEV TEXOFLEX AL Q 110                            | ART.001-379 |
|                                                                                     | <b>90824</b>   | FLEXIBILNA CIJEV TEXOFLEX AL Q 120                            | ART.001-380 |
|                                                                                     | <b>90825</b>   | FLEXIBILNA CIJEV TEXOFLEX AL Q 160                            | ART.001-634 |
|                                                                                     | <b>90826</b>   | FLEXIBILNA CIJEV TEXOFLEX AL Q 180                            | ART.001-635 |
|    | <b>90827</b>   | SIFON FLEXIBILNI BEZ PILETE 5/4"                              | ART.120-517 |
|                                                                                     | <b>90828</b>   | SIFON FLEXIBILNI BEZ PILETE 6/4"                              | ART.120-706 |
|    | <b>90829</b>   | SIFON FLEXIBILNI ZA UMIVAONIK SA PILETOM 5/4"                 | ART.120-511 |
|                                                                                     | <b>90830</b>   | SIFON FLEXIBILNI ZA SUDOPER SA PILETOM 5/4"                   | ART.120-705 |
|                                                                                     | <b>90831</b>   | SIFON FLEXIBILNI ZA TUŠ KADU                                  | ART.120-533 |
|    | <b>90832</b>   | SIFON FLEXIBILNI ZA KADU                                      | ART.120-313 |
|   | <b>90833</b>   | SIFON FLEXIBILNI DVODJELNI                                    | ART.120-312 |
|  | <b>90834</b>   | SIFON FLEXIBILNI DVODJELNI SA PRELJEVOM                       | ART.120-377 |
|                                                                                     | <b>0527025</b> | SIFON FLEXIBILNI DVODJELNI SA REŠETKOM Ø 114 mm I PRELJEVOM   | ART.120-740 |
|  | <b>90835</b>   | SIFON FLEXIBILNI JEDNODJELNI SA PRELJEVOM                     | ART.120-314 |
|                                                                                     | <b>0527024</b> | SIFON FLEXIBILNI JEDNODJELNI SA REŠETKOM Ø 114 mm I PRELJEVOM | ART.120-739 |
|  | <b>0527026</b> | SIFON ZA TUŠ KADU FLEXIBILNI NISKI 60 mm                      | ART.120-797 |
|  | <b>90836</b>   | WC PRIKLJUČAK RAVNI                                           | ART.120-350 |
|  | <b>90837</b>   | WC PRIKLJUČAK EKSCENTRIČNI                                    | ART.120-349 |
|  | <b>0527023</b> | ČEP ZA SIFONE                                                 | ART.120-375 |
|  | <b>90838</b>   | WC PRIKLJUČAK HARMONIKA 40 cm                                 | ART.120-317 |
|                                                                                     | <b>90839</b>   | WC PRIKLJUČAK HARMONIKA 60 cm                                 | ART.120-381 |
|  | <b>90840</b>   | ISPIRNA FLEXIBILNA CIJEV ZA VODOKOTLIĆ 60 cm                  | ART.120-316 |
|                                                                                     | <b>90841</b>   | ISPIRNA FLEXIBILNA CIJEV ZA VODOKOTLIĆ 100 cm                 | ART.120-621 |

|                                                                                                                                                                                                         |                                                                                                                                                         |                                                                                                                                                      |
|---------------------------------------------------------------------------------------------------------------------------------------------------------------------------------------------------------|---------------------------------------------------------------------------------------------------------------------------------------------------------|------------------------------------------------------------------------------------------------------------------------------------------------------|
|  <p>VENTIL ZA STOJEĆI PISOAR<br/> <b>68001</b> FIKSNA ROZETA ART.323T<br/> <b>0523039</b> POKRETNNA ROZETA ART.315</p> |  <p><b>68002</b> VENTIL ZA PISOAR AUTOMATSKI NA PRITISAK ART.316</p>   |  <p><b>68003</b> VENTIL ZA PISOAR ART.308 A</p>                   |
|  <p><b>42396</b> PRIKLJUČAK ZA PISOAR ART.303 A</p>                                                                    |  <p><b>68004</b> ISPIRAČ ZA WC AUTOMATSKI NA PRITISAK ART.472</p>      |  <p><b>68005</b> ISPIRNA CIJEV 3/4" ZA ISPIRAČ ART.477</p>        |
|  <p><b>11543</b> RASPRŠIVAČ ZA STOJEĆI PISOAR ART.323</p>                                                            |  <p><b>68017</b> KONZOLA NOSAČ ZA BIDE I ŠKOLJKU ART.1820(14301)</p> |  <p><b>11175</b> PILETA ZA STOJEĆI PISOAR ART.(56949)313</p>    |
|  <p><b>68006</b> SLAVINA USADNA NA PRITISAK ART.461</p>                                                              |  <p><b>68007</b> POKRETNNA SLAVINA NA PRITISAK ART.462 A</p>         |  <p><b>68012</b> VIJCI ZA VALENTINU, MAJORU I SL. ART.1802C</p> |
|  <p><b>0523033</b> PODŽBUKNA BATERIJA NA PRITISAK ART.467</p>                                                        |  <p><b>0523032</b> CENTRALNA TERMOSTATSKA MJEŠALICA 1" ART.445</p>   |  <p><b>68027</b> ZIDNA IZLJEVNA CIJEV ART.482</p>               |

|                                                                                                                                                                                                                                |                                                                                                                                                                                                               |                                                                                                                                                                                                                                                                                                                 |
|--------------------------------------------------------------------------------------------------------------------------------------------------------------------------------------------------------------------------------|---------------------------------------------------------------------------------------------------------------------------------------------------------------------------------------------------------------|-----------------------------------------------------------------------------------------------------------------------------------------------------------------------------------------------------------------------------------------------------------------------------------------------------------------|
|  <p>MEHANIZAM PNEUMATSKI<br/>ZA VODOKOTLIĆ</p> <p><b>68008</b> CROM ART.160.212.15<br/><b>68009</b> ZLATO ART.160.212.15</p>                  |  <p>MEHANIZAM PNEUMATSKI<br/>ZA VODOKOTLIĆ</p> <p><b>68010</b> CROM ART.160.212.18<br/><b>68011</b> ZLATO ART.160.212.18</p> |  <p>MEHANIZAM PNEUMATSKI<br/>ZA VODOKOTLIĆ</p> <p><b>0523036</b> CROM ART.90.212.15</p>                                                                                                                                      |
|  <p>MEHANIZAM PNEUMATSKI<br/>ZA VODOKOTLIĆ</p> <p><b>0523035</b> CROM ART.90.212</p>                                                         |  <p><b>68015</b> BRTVA ZA PISOAR 35x14 ART.99<br/><b>68016</b> BRTVA ZA PISOAR 50x14 ART.99 A</p>                           |  <p><b>68022</b> GUMA ZA VODOKOTLIĆ<br/>MONBLOK ART.12.3</p>  <p><b>42380</b> PRIKLJUČAK ZA PISOAR<br/>VOLGU IZ ZIDA ART.FM ZA 2975</p> |
|  <p><b>68025</b> PODNA VIŠENAMJENSKA SLAVINA<br/>SA REGULACIJOM ART.469<br/><b>68026</b> REZERVNA KARTUŠA<br/>ZA (ART.469). ART.460.469</p> |  <p><b>68021</b> UNIVERZALNA SLAVINA NA<br/>PEDALU, MOŽE SE INSTALIRATI<br/>NA POD I NA ZID ART.486</p>                   |  <p><b>68018</b> UNIVERZALNI ČEP CROM ART.39 U<br/><b>68019</b> UNIVERZALNI ČEP ZLATO ART.39</p>                                                                                                                           |
|  <p><b>68023</b> IZLJEVNA CIJEV<br/>ZA UMIVAONIK ART.483</p>                                                                                |  <p><b>68028</b> IZLJEVNA CIJEV<br/>ZA SUDOPER ART.481</p>                                                                 |  <p><b>0523031</b> VENTIL S TUŠEM I VREMENSKIM<br/>ZATVARAČEM ART.488</p>                                                                                                                                                  |





Bathroom  
without compromise

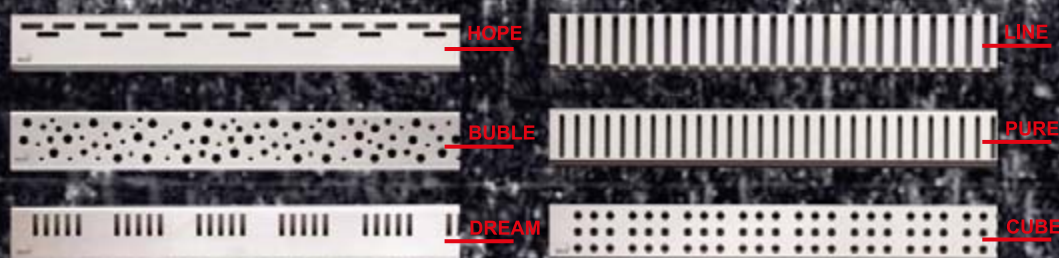

- 1 Priprema**  
Prije instalacije oprezno pročitajte upute.  
Provjerite dužinu kanalice.



- 2 Postavite kanalicu na željeno mjesto ugradnje**  
Učvrstite kanalicu pomoću isporučenog montažnog seta, prilagodite visinu i prilagodite pad vode prema tuš kanalici.  
Spojite odvodnu cijev.



- 3 Postavljanje estriha**  
Estrih se postavlja do visine izolacije.  
Nanijeti praimer na estrih.



- 4 Vodootpornost**  
Skinuti zaštitnu foliju te postavite vodootpornu traku koja se nalazi u pakiranju. Vodootpornom trakom prekrijte okvir kanalice.  
Prijelazni dio trake zalijepiti za estrih.  
Prekrijte estrih sa dodatnom izolacijskim trakama ili koristite vodootpornu foliju.

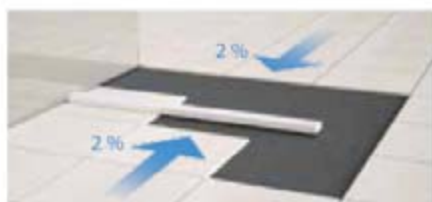

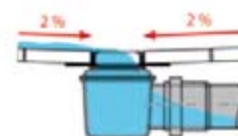
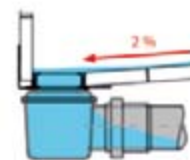

- 5 Ugradnja keramike**  
Postavite keramiku a spoj između ruba keramike i okvira kanalice popunite elastičnim materijalom-silikonom.



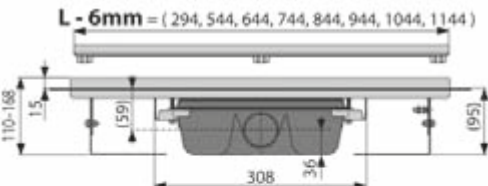
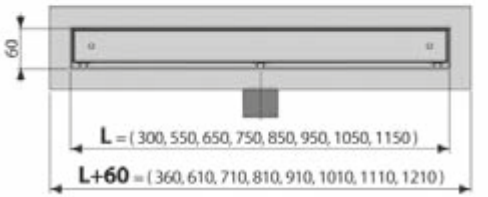

|  |                |                                                   |               |
|--|----------------|---------------------------------------------------|---------------|
|  | <b>0528076</b> | TUŠ KANALICA SA SIFONOM<br>300 mm AlcaPLAST       | ART.APZ1-300  |
|  | <b>0528077</b> | TUŠ KANALICA SA SIFONOM<br>550 mm AlcaPLAST       | ART.APZ1-550  |
|  | <b>0528075</b> | TUŠ KANALICA SA SIFONOM<br>650 mm AlcaPLAST       | ART.APZ1-650  |
|  | <b>0528025</b> | TUŠ KANALICA SA SIFONOM<br>750 mm AlcaPLAST       | ART.APZ1-750  |
|  | <b>0528026</b> | TUŠ KANALICA SA SIFONOM<br>850 mm AlcaPLAST       | ART.APZ1-850  |
|  | <b>0528027</b> | TUŠ KANALICA SA SIFONOM<br>950 mm AlcaPLAST       | ART.APZ1-950  |
|  | <b>0528028</b> | TUŠ KANALICA SA SIFONOM<br>1050 mm AlcaPLAST      | ART.APZ1-1050 |
|  | <b>0528078</b> | TUŠ KANALICA SA SIFONOM<br>1150 mm AlcaPLAST      | ART.APZ1-1150 |
|  | <b>0528079</b> | REŠETKA ZA TUŠ KANALICU PURE<br>300 mm AlcaPLAST  | ART.300M      |
|  | <b>0528080</b> | REŠETKA ZA TUŠ KANALICU PURE<br>550 mm AlcaPLAST  | ART.550M      |
|  | <b>0528073</b> | REŠETKA ZA TUŠ KANALICU PURE<br>650 mm AlcaPLAST  | ART.650M      |
|  | <b>0528029</b> | REŠETKA ZA TUŠ KANALICU PURE<br>750 mm AlcaPLAST  | ART.750M      |
|  | <b>0528030</b> | REŠETKA ZA TUŠ KANALICU PURE<br>850 mm AlcaPLAST  | ART.850M      |
|  | <b>0528031</b> | REŠETKA ZA TUŠ KANALICU PURE<br>950 mm AlcaPLAST  | ART.950M      |
|  | <b>0528032</b> | REŠETKA ZA TUŠ KANALICU PURE<br>1050 mm AlcaPLAST | ART.1050M     |
|  | <b>0528081</b> | REŠETKA ZA TUŠ KANALICU PURE<br>1150 mm AlcaPLAST | ART.1150M     |
|  | <b>0528082</b> | REŠETKA ZA TUŠ KANALICU CUBE<br>300 mm AlcaPLAST  | ART.300M      |
|  | <b>0528083</b> | REŠETKA ZA TUŠ KANALICU CUBE<br>550 mm AlcaPLAST  | ART.550M      |
|  | <b>0528074</b> | REŠETKA ZA TUŠ KANALICU CUBE<br>650 mm AlcaPLAST  | ART.650M      |
|  | <b>0528033</b> | REŠETKA ZA TUŠ KANALICU CUBE<br>750 mm AlcaPLAST  | ART.750M      |
|  | <b>0528034</b> | REŠETKA ZA TUŠ KANALICU CUBE<br>850 mm AlcaPLAST  | ART.850M      |
|  | <b>0528035</b> | REŠETKA ZA TUŠ KANALICU CUBE<br>950 mm AlcaPLAST  | ART.950M      |
|  | <b>0528036</b> | REŠETKA ZA TUŠ KANALICU CUBE<br>1050 mm AlcaPLAST | ART.1050M     |
|  | <b>0528084</b> | REŠETKA ZA TUŠ KANALICU CUBE<br>1150 mm AlcaPLAST | ART.1150M     |

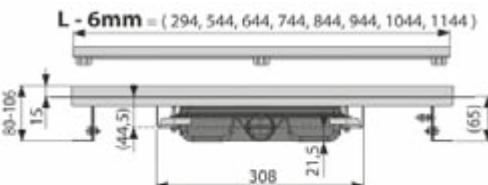
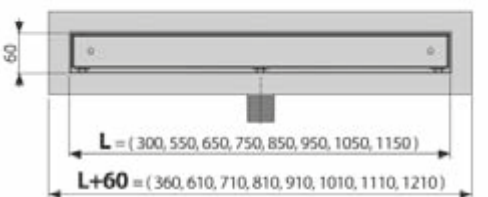
|                                                                                                                                                                                                                                                                   |                                                                   |                                                                                                                                                                                                                                                                                                                                                          |
|-------------------------------------------------------------------------------------------------------------------------------------------------------------------------------------------------------------------------------------------------------------------|-------------------------------------------------------------------|----------------------------------------------------------------------------------------------------------------------------------------------------------------------------------------------------------------------------------------------------------------------------------------------------------------------------------------------------------|
| <br><br>       | <p><b>0528098</b></p> <p><b>0528099</b></p> <p><b>0528100</b></p> | <p>TUŠ KANALICA S PROFILOM ZA UMETANJE KERAMIKE APZ7 FLOOR 650 mm AlcaPLAST ART.APZ7-650</p> <p>TUŠ KANALICA S PROFILOM ZA UMETANJE KERAMIKE APZ7 FLOOR 750 mm AlcaPLAST ART.APZ7-750</p> <p>TUŠ KANALICA S PROFILOM ZA UMETANJE KERAMIKE APZ7 FLOOR 850 mm AlcaPLAST ART.APZ7-850</p>                                                                   |
| <br><br> | <p><b>0528101</b></p> <p><b>0528102</b></p> <p><b>0528103</b></p> | <p>TUŠ KANALICA NISKA IZVEDBA S PROFILOM ZA UMETANJE KERAMIKE APZ107 FLOOR LOW 650 mm AlcaPLAST ART.APZ107-650</p> <p>TUŠ KANALICA NISKA IZVEDBA S PROFILOM ZA UMETANJE KERAMIKE APZ107 FLOOR LOW 750 mm AlcaPLAST ART.APZ107-750</p> <p>TUŠ KANALICA NISKA IZVEDBA S PROFILOM ZA UMETANJE KERAMIKE APZ107 FLOOR LOW 850 mm AlcaPLAST ART.APZ107-850</p> |



### TUŠ KANALICA VISOKA I NISKA IZVEDBA

APZ7 95 mm

APZ107 65 mm

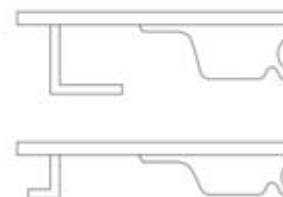

|  |                |                                                                                  |               |
|--|----------------|----------------------------------------------------------------------------------|---------------|
|  | <b>0528089</b> | TUŠ KANALICA PVC S INOX REŠETKOM<br>550 mm AlcaPLAST                             | ART.APZ8-550M |
|  | <b>0528088</b> | TUŠ KANALICA PVC S INOX REŠETKOM<br>650 mm AlcaPLAST                             | ART.APZ8-650M |
|  | <b>0528061</b> | TUŠ KANALICA PVC S INOX REŠETKOM<br>750 mm AlcaPLAST                             | ART.APZ8-750M |
|  | <b>0528062</b> | TUŠ KANALICA PVC S INOX REŠETKOM<br>850 mm AlcaPLAST                             | ART.APZ8-850M |
|  | <b>0528063</b> | TUŠ KANALICA PVC S INOX REŠETKOM<br>950 mm AlcaPLAST                             | ART.APZ8-950M |
|  | <b>0528091</b> | TUŠ KANALICA PVC S INOX REŠETKOM<br>550 mm AlcaPLAST                             | ART.APZ9-550M |
|  | <b>0528090</b> | TUŠ KANALICA PVC S INOX REŠETKOM<br>650 mm AlcaPLAST                             | ART.APZ9-650M |
|  | <b>0528064</b> | TUŠ KANALICA PVC S INOX REŠETKOM<br>750 mm AlcaPLAST                             | ART.APZ9-750M |
|  | <b>0528065</b> | TUŠ KANALICA PVC S INOX REŠETKOM<br>850 mm AlcaPLAST                             | ART.APZ9-850M |
|  | <b>0528066</b> | TUŠ KANALICA PVC S INOX REŠETKOM<br>950 mm AlcaPLAST                             | ART.APZ9-950M |
|  | <b>0528049</b> | REŠETKA KUTNA LIFE AlcaPLAST                                                     | ART.LIFE      |
|  | <b>0528058</b> | KUTNI SIFON AlcaPLAST                                                            | ART.ARZ1      |
|  | <b>0528050</b> | FLEKSIBILNA CIJEV $\varnothing$ 32/40<br>S PLASTIČNOM MATICOM 5/4"<br>350-800 mm | ART.A75       |
|  | <b>0528051</b> | FLEKSIBILNA CIJEV $\varnothing$ 32/40<br>S METALNOM MATICOM 5/4"<br>350-800 mm   | ART.A76       |



|  |                |                                                                                  |            |
|--|----------------|----------------------------------------------------------------------------------|------------|
|  | <b>0528052</b> | FLEKSIBILNA CIJEV $\varnothing$ 40/50<br>S PLASTIČNOM MATICOM 6/4"<br>400-850 mm | ART.A77    |
|  | <b>0528053</b> | FLEKSIBILNA CIJEV $\varnothing$ 40/50<br>S METALNOM MATICOM 6/4"<br>400-850 mm   | ART.A78    |
|  | <b>0528054</b> | OZRAČNI KAPA VENTIL $\varnothing$ 50                                             | ART.APH50  |
|  | <b>0528055</b> | OZRAČNI KAPA VENTIL $\varnothing$ 75                                             | ART.APH75  |
|  | <b>0528056</b> | OZRAČNI KAPA VENTIL $\varnothing$ 110                                            | ART.APH110 |
|  | <b>0528057</b> | MAGNETNA VRATAŠČA ZA KADU                                                        | ART.AVD005 |

|  |                |                                                               |               |
|--|----------------|---------------------------------------------------------------|---------------|
|  | <b>0528045</b> | MEHANIZAM ZA VODOKOTLIĆ SA DVOSTRUKIM ISPIRANJEM<br>AlcaPLAST | ART.A08       |
|  | <b>0528046</b> | PLOVAK ZA PLASTIČNI VODOKOTLIĆ<br>3/8" AlcaPLAST              | ART.A16P 3/8" |
|  | <b>0528071</b> | PLOVAK ZA KERAMIČKI VODOKOTLIĆ<br>3/8" AlcaPLAST              | ART.A16 3/8"  |
|  | <b>0528037</b> | SIFON ZA UMIVAONIK LUX-AlcaPLAST<br>5/4" ø 32                 | ART.A400      |
|  | <b>0528039</b> | SIFON ZA UMIVAONIK LUX-AlcaPLAST<br>5/4" ø 32                 | ART.A401      |
|  | <b>0528069</b> | DONJI DIO SIFONA AlcaPLAST<br>5/4" ø 32                       | ART.A434      |
|  | <b>0528070</b> | PRODUŽETAK ZA SIFON AlcaPLAST<br>5/4" ø 32                    | ART.A4000     |



|                                                                                     |         |                                         |      |               | PAK / KOM<br>Veliko/Malo |
|-------------------------------------------------------------------------------------|---------|-----------------------------------------|------|---------------|--------------------------|
|    | 04176   | SLAVINA S PRIKLJUČKOM                   | 1/2" | ART.220       | 84/12                    |
|    | 04554   | SLAVINA KROMIRANA 1/2" S DVA PRIKLJUČKA |      | ART."UNI" 240 | 78/6                     |
|    | 0201407 | SLAVINA S PRIKLJUČKOM                   | 1/2" | ART.225       | 156/12                   |
|   | 04088   | SLAVINA S PRIKLJUČKOM                   | 1/2" | ART.250       | 156/12                   |
|  | 04089   | VENTIL S PRIKLJUČKOM                    | 1/2" | ART.255       | 100/10                   |
|  | 0201315 | PRIKLJUČAK ZA PERILICU<br>SA NASTAVKOM  | 3/4" | ART."UNI" 230 | 78/6                     |
|  | 04093   | SIFON ZA PERILICU                       | 3/4" | ART. 390      | 72/6                     |
|  | 04152   | PRIKLJUČNI HOLENDER ZA SLAVINU          | 3/4" | ART.280       | 1200/100                 |
|                                                                                     | 04383   | PRIKLJUČNI HOLENDER ZA SLAVINU          | 1"   | ART.280       | 600/50                   |
|                                                                                     | 0201330 | PRIKLJUČNI HOLENDER ZA SLAVINU          | 5/4" | ART.280       | 300/25                   |
|  | 04090   | ROZETA                                  | 1/2" | ART. INOX 285 | 4000/100                 |

|                                                                                     |                |                                           |         | PAK / KOM<br>Veliko/Malo |
|-------------------------------------------------------------------------------------|----------------|-------------------------------------------|---------|--------------------------|
|    | <b>04100</b>   | KUTNI VENTIL 1/2"                         | ART.348 | 160/10                   |
|    | <b>04208</b>   | KUTNI VENTIL ZA VODOKOTLIČ 1/2"           | ART.346 | 160/10                   |
|    | <b>04557</b>   | KUTNI KUGLA VENTIL S FILTEROM 1/2"x3/8"   | ART.906 | 180/10                   |
|  | <b>04417</b>   | KUTNI KUGLA VENTIL S FILTEROM 1/2"-3/8"   | ART.385 | 130/10                   |
|  | <b>0201297</b> | VENTIL KUTNI S NASTAVKOM 1/2"             | ART.386 | 130/10                   |
|  | <b>04555</b>   | KUTNI VENTIL 1/2" S PRIKLJUČKOM 3/4"      | ART.387 | 75/1                     |
|  | <b>04556</b>   | KUGLASTI PRIKLJUČAK ZA PERILICU 1/2"x3/4" | ART.706 | 180/10                   |



|                                                                                     |                                                                                     |                        |                        |            |
|-------------------------------------------------------------------------------------|-------------------------------------------------------------------------------------|------------------------|------------------------|------------|
|    | 11194                                                                               | PRODUŽETAK CROM.       | 3/8" 1 cm              | ART.651001 |
|                                                                                     | 11195                                                                               | PRODUŽETAK CROM.       | 3/8" 1,5 cm            | ART.651004 |
|                                                                                     | 42305                                                                               | PRODUŽETAK CROM.       | 3/8" 2 cm              | ART.651008 |
|                                                                                     | 11034                                                                               | PRODUŽETAK CROM.       | 1/2" 1 cm              | ART.651002 |
|                                                                                     | 11041                                                                               | PRODUŽETAK CROM.       | 1/2" 1,5 cm            | ART.651005 |
|                                                                                     | 11040                                                                               | PRODUŽETAK CROM.       | 1/2" 2 cm              | ART.651009 |
|                                                                                     | 11430                                                                               | PRODUŽETAK CROM.       | 1/2" 2,5 cm            | ART.651013 |
|                                                                                     | 11425                                                                               | PRODUŽETAK CROM.       | 1/2" 3 cm              | ART.651017 |
|                                                                                     | 42306                                                                               | PRODUŽETAK CROM.       | 1/2" 3,5 cm            | ART.688441 |
|                                                                                     | 42307                                                                               | PRODUŽETAK CROM.       | 1/2" 4 cm              | ART.651021 |
|    | 42308                                                                               | REDUKCIJA OTER TIP.240 | 3/8"-1/4"              | ART.652001 |
|                                                                                     | 42309                                                                               | REDUKCIJA OTER TIP.240 | 1/2"-1/4"              | ART.652083 |
|                                                                                     | 11415                                                                               | REDUKCIJA OTER TIP.240 | 1/2"-3/8"              | ART.652003 |
|                                                                                     | 42124                                                                               | REDUKCIJA OTER TIP.240 | 3/4"-1/4"              | ART.688893 |
|                                                                                     | 42310                                                                               | REDUKCIJA OTER TIP.240 | 3/4"-3/8"              | ART.652067 |
|                                                                                     | 42311                                                                               | REDUKCIJA OTER TIP.240 | 3/4"-1/2"              | ART.652005 |
|   | 42312                                                                               | REDUKCIJA OTER TIP.241 | 1/4"-1/8"              | ART.652011 |
|                                                                                     | 42313                                                                               | REDUKCIJA OTER TIP.241 | 3/8"-1/8"              | ART.652050 |
|                                                                                     | 42314                                                                               | REDUKCIJA OTER TIP.241 | 3/8"-1/4"              | ART.652013 |
|                                                                                     | 42315                                                                               | REDUKCIJA OTER TIP.241 | 1/2"-1/8"              | ART.652111 |
|                                                                                     | 42316                                                                               | REDUKCIJA OTER TIP.241 | 1/2"-1/4"              | ART.652015 |
|                                                                                     | 42317                                                                               | REDUKCIJA OTER TIP.241 | 1/2"-3/8"              | ART.652017 |
|                                                                                     | 42318                                                                               | REDUKCIJA OTER TIP.241 | 3/4"-1/4"              | ART.652052 |
|                                                                                     | 42319                                                                               | REDUKCIJA OTER TIP.241 | 3/4"-3/8"              | ART.652019 |
|                                                                                     | 42320                                                                               | REDUKCIJA OTER TIP.241 | 3/4"-1/2"              | ART.652021 |
|                                                                                     |  | 42321                  | REDUKCIJA OTER TIP.245 | 1/4"-1/8"  |
| 42322                                                                               |                                                                                     | REDUKCIJA OTER TIP.245 | 3/8"-1/4"              | ART.652002 |
| 42203                                                                               |                                                                                     | REDUKCIJA OTER TIP.245 | 1/2"-1/4"              | ART.652004 |
| 42323                                                                               |                                                                                     | REDUKCIJA OTER TIP.245 | 1/2"-3/8"              | ART.652006 |
| 42324                                                                               |                                                                                     | REDUKCIJA OTER TIP.245 | 3/4"-3/8"              | ART.652010 |
| 42325                                                                               |                                                                                     | REDUKCIJA OTER TIP.245 | 3/4"-1/2"              | ART.652012 |
| 42326                                                                               |                                                                                     | REDUKCIJA OTER TIP.245 | 1"-1/2"                | ART.652014 |
| 42327                                                                               |                                                                                     | REDUKCIJA OTER TIP.245 | 1"-3/4"                | ART.652016 |
|  | 11834                                                                               | REDUKCIJA OTER TIP.246 | 3/8"-1/4"              | ART.652002 |
|                                                                                     | 42328                                                                               | REDUKCIJA OTER TIP.246 | 1/2"-3/8"              | ART.651028 |
|                                                                                     | 42329                                                                               | REDUKCIJA OTER TIP.246 | 3/4"-1/2"              | ART.651029 |
|  | 0153001                                                                             | MS PRODUŽETAK          | 1/2x10 MM              | ART.8450   |
|                                                                                     | 0153002                                                                             | MS PRODUŽETAK          | 1/2x15 MM              | ART.8451   |
|                                                                                     | 0153003                                                                             | MS PRODUŽETAK          | 1/2x20 MM              | ART.8452   |
|                                                                                     | 0153004                                                                             | MS PRODUŽETAK          | 1/2x25 MM              | ART.8453   |
|                                                                                     | 0153005                                                                             | MS PRODUŽETAK          | 1/2x30 MM              | ART.8454   |
|                                                                                     | 0153006                                                                             | MS PRODUŽETAK          | 1/2x40 MM              | ART.8455   |
|                                                                                     | 0153007                                                                             | MS PRODUŽETAK          | 1/2x50 MM              | ART.8456   |





|                                                                                     |                               |                                           |                          |
|-------------------------------------------------------------------------------------|-------------------------------|-------------------------------------------|--------------------------|
|    | 42330                         | NIPEL OTER TIP.280 1/8"                   | ART.655013               |
|                                                                                     | 11826                         | NIPEL OTER TIP.280 1/4"                   | ART.655001               |
|                                                                                     | 11079                         | NIPEL OTER TIP.280 3/8"                   | ART.(42412)655002        |
|                                                                                     | 42331                         | NIPEL OTER TIP.280 1/2"                   | ART.(42414)655003        |
|                                                                                     | 42332                         | NIPEL OTER TIP.280 3/4"                   | ART.655004               |
|                                                                                     | 42333                         | NIPEL OTER TIP.280 1"                     | ART.655005               |
|    | 42334                         | MUFNA OTER TIP.268Z 1/8"                  | ART.42392                |
|                                                                                     | 42335                         | MUFNA OTER TIP.268Z 1/4"                  | ART.42394                |
|                                                                                     | 42336                         | MUFNA OTER TIP.268Z 3/8"                  | ART.42396                |
|                                                                                     | 42337                         | MUFNA OTER TIP.268Z 1/2"                  | ART.42398                |
|                                                                                     | 42338                         | MUFNA OTER TIP.268Z 3/4"                  | ART.42400                |
|    | 42339                         | ČEP OTER TIP.292 1/8"                     | ART.648014               |
|                                                                                     | 42340                         | ČEP OTER TIP.292 1/4"                     | ART.648006               |
|                                                                                     | 42341                         | ČEP OTER TIP.292 3/8"                     | ART.648007               |
|                                                                                     | 42342                         | ČEP OTER TIP.292 1/2"                     | ART.648008               |
|                                                                                     | 42343                         | ČEP OTER TIP.292 3/4"                     | ART.648009               |
|                                                                                     | 42344                         | ČEP OTER TIP.292 1"                       | ART.648010               |
|   | 42345                         | NIPEL PRODUŽNI OTER TIP.531 3/8"          | ART.649001               |
|                                                                                     | 42346                         | NIPEL PRODUŽNI OTER TIP.531 1/2"          | ART.649002               |
|                                                                                     | 42347                         | NIPEL PRODUŽNI OTER TIP.531 3/4"          | ART.649003               |
|                                                                                     | 42348                         | NIPEL PRODUŽNI OTER TIP.531 1"            | ART.649004               |
|  | 11297                         | DRŽAČ CIJEVI OTER TIP.830P 1/2"           | ART.(42311)055022,64212  |
|                                                                                     | 11298                         | DRŽAČ CIJEVI OTER TIP.830P 3/4"           | ART.(42313)055023,64234  |
|                                                                                     | 11299                         | DRŽAČ CIJEVI OTER TIP.830P 1"             | ART.(42323)055024,64210  |
|                                                                                     | 11300                         | DRŽAČ CIJEVI OTER TIP.830P 5/4"           | ART.(42319)055025,642114 |
|                                                                                     | 11301                         | DRŽAČ CIJEVI OTER TIP.830P 6/4"           | ART.(42325)055026,642112 |
|                                                                                     | 11431                         | DRŽAČ CIJEVI OTER TIP.830P 2"             | ART.(42327)055027,64220  |
|                                                                                     | 11432                         | DRŽAČ CIJEVI OTER TIP.830P 2 1/2"         | ART.(42353)055041,642212 |
| 11433                                                                               | DRŽAČ CIJEVI OTER TIP.830P 3" | ART.42347,64230                           |                          |
|  | 11835                         | DRŽAČ CIJEVI S VIJKOM OTER TIP.1040 Ø 50  | ART.688468               |
|                                                                                     | 11831                         | DRŽAČ CIJEVI S VIJKOM OTER TIP.1040 Ø 75  | ART.688471               |
|                                                                                     | 11854                         | DRŽAČ CIJEVI S VIJKOM OTER TIP.1040 Ø 110 | ART.688473               |
|                                                                                     | 11832                         | DRŽAČ CIJEVI S VIJKOM OTER TIP.1040 Ø 125 | ART.688474               |
|                                                                                     | 11833                         | DRŽAČ CIJEVI S VIJKOM OTER TIP.1040 Ø 160 | ART.688476               |
|  | 39028                         | OBUJMICA METALNA DVODJELNA 3/8"           |                          |
|                                                                                     | 39029                         | OBUJMICA METALNA DVODJELNA 1/2"           |                          |
|                                                                                     | 39030                         | OBUJMICA METALNA DVODJELNA 3/4"           |                          |
|                                                                                     | 39031                         | OBUJMICA METALNA DVODJELNA 1"             |                          |
|                                                                                     | 39032                         | OBUJMICA METALNA DVODJELNA 5/4"           |                          |
|                                                                                     | 39033                         | OBUJMICA METALNA DVODJELNA 6/4"           |                          |
|                                                                                     | 39034                         | OBUJMICA METALNA DVODJELNA 2"             |                          |

|                                                                                     |         |                                  |               |
|-------------------------------------------------------------------------------------|---------|----------------------------------|---------------|
|    | 0203037 | KOLJENO KROMIRANO M-Ž 3/8" RM    | ART.45138     |
|                                                                                     | 0203038 | KOLJENO KROMIRANO M-Ž 1/2" RM    | ART.45112     |
|                                                                                     | 0203039 | KOLJENO KROMIRANO M-Ž 3/4" RM    | ART.45134     |
|                                                                                     | 0203118 | KOLJENO KROMIRANO M-Ž 1" RM      | ART.45110     |
|    | 0203040 | KOLJENO KROMIRANO Ž-Ž 3/8" RM    | ART.45238     |
|                                                                                     | 0203041 | KOLJENO KROMIRANO Ž-Ž 1/2" RM    | ART.45212     |
|                                                                                     | 0203042 | KOLJENO KROMIRANO Ž-Ž 3/4" RM    | ART.45234     |
|                                                                                     | 0203119 | KOLJENO KROMIRANO Ž-Ž 1" RM      | ART.45210     |
|   | 0203043 | TE KOMAD KROMIRANI 3/8" RM       | ART.45338     |
|                                                                                     | 0203044 | TE KOMAD KROMIRANI 1/2" RM       | ART.45312     |
|                                                                                     | 0203045 | TE KOMAD KROMIRANI 3/4" RM       | ART.45334     |
|                                                                                     | 0203120 | TE KOMAD KROMIRANI 1" RM         | ART.45310     |
|  | 0203046 | MUFNA KROMIRANA 3/8" RM          | ART.45438     |
|                                                                                     | 0203047 | MUFNA KROMIRANA 1/2" RM          | ART.45412     |
|                                                                                     | 0203048 | MUFNA KROMIRANA 3/4" RM          | ART.45434     |
|                                                                                     | 0203121 | MUFNA KROMIRANA 1" RM            | ART.45410     |
|  | 0203122 | PRODUŽETAK KROMIRANI 3/4"x10 RM  | ART.5023410   |
|                                                                                     | 0203123 | PRODUŽETAK KROMIRANI 3/4"x15 RM  | ART.5023415   |
|                                                                                     | 0203124 | PRODUŽETAK KROMIRANI 3/4"x20 RM  | ART.5023420   |
|                                                                                     | 0203125 | PRODUŽETAK KROMIRANI 3/4"x25 RM  | ART.5023425   |
|                                                                                     | 0203126 | PRODUŽETAK KROMIRANI 3/4"x30 RM  | ART.5023430   |
|                                                                                     | 0203127 | PRODUŽETAK KROMIRANI 3/4"x40 RM  | ART.5023440   |
|                                                                                     | 0203128 | PRODUŽETAK KROMIRANI 3/4"x50 RM  | ART.5023450   |
|  | 0203129 | PRODUŽETAK KROMIRANI 1/2"x10 RM  | ART.502P1210  |
|                                                                                     | 0203130 | PRODUŽETAK KROMIRANI 1/2"x15 RM  | ART.502P1215  |
|                                                                                     | 0203131 | PRODUŽETAK KROMIRANI 1/2"x20 RM  | ART.502P1220  |
|                                                                                     | 0203132 | PRODUŽETAK KROMIRANI 1/2"x25 RM  | ART.502P1225  |
|                                                                                     | 0203133 | PRODUŽETAK KROMIRANI 1/2"x30 RM  | ART.502P1230  |
|                                                                                     | 0203134 | PRODUŽETAK KROMIRANI 1/2"x40 RM  | ART.502P1240  |
|                                                                                     | 0203135 | PRODUŽETAK KROMIRANI 1/2"x50 RM  | ART.502P1250  |
|                                                                                     | 0203136 | PRODUŽETAK KROMIRANI 1/2"x60 RM  | ART.502P1260  |
|                                                                                     | 0203137 | PRODUŽETAK KROMIRANI 1/2"x80 RM  | ART.502P1280  |
|                                                                                     | 0203138 | PRODUŽETAK KROMIRANI 1/2"x100 RM | ART.502P12100 |

|                                                                                     |                |                                       |             |
|-------------------------------------------------------------------------------------|----------------|---------------------------------------|-------------|
|    | <b>0203139</b> | NIPEL KROMIRANI 3/8" RM               | ART.52038   |
|                                                                                     | <b>0203140</b> | NIPEL KROMIRANI 1/2" RM               | ART.52012   |
|                                                                                     | <b>0203141</b> | NIPEL KROMIRANI 3/4" RM               | ART.52034   |
|                                                                                     | <b>0203142</b> | NIPEL KROMIRANI 1" RM                 | ART.52010   |
|    | <b>0203143</b> | REDUKCIJA KROMIRANA 1/4"x 3/8" RM     | ART.5111438 |
|                                                                                     | <b>0203144</b> | REDUKCIJA KROMIRANA 3/8"x 1/2" RM     | ART.5113812 |
|                                                                                     | <b>0203145</b> | REDUKCIJA KROMIRANA 1/2"x 3/4" RM     | ART.5111234 |
|                                                                                     | <b>0203146</b> | REDUKCIJA KROMIRANA 3/4"x 1" RM       | ART.5113410 |
|   | <b>0203147</b> | "Y" KROMIRANI 3/4" F x 3/4" x 3/4" RM | ART.209YCR  |
|  | <b>0203148</b> | ČEP KROMIRANI 3/8" RM                 | ART.52338   |
|                                                                                     | <b>0203149</b> | ČEP KROMIRANI 1/2" RM                 | ART.52312   |
|                                                                                     | <b>0203150</b> | ČEP KROMIRANI 3/4" RM                 | ART.52334   |
|                                                                                     | <b>0203151</b> | ČEP KROMIRANI 1" RM                   | ART.52310   |
|  | <b>0203152</b> | ČEP KROMIRANI "Ž" 3/8" RM             | ART.52438   |
|                                                                                     | <b>0203153</b> | ČEP KROMIRANI "Ž" 1/2" RM             | ART.52412   |
|                                                                                     | <b>0203154</b> | ČEP KROMIRANI "Ž" 3/4" RM             | ART.52434   |
|                                                                                     | <b>0203155</b> | ČEP KROMIRANI "Ž" 1" RM               | ART.52410   |

**PRODUŽETCI, REDUKCIJE I SLIČNO OD BRONZE, PRESVUČENO KROMOM**



PAK M/V

|                                                                                     |                          |                                                                        |             |    |
|-------------------------------------------------------------------------------------|--------------------------|------------------------------------------------------------------------|-------------|----|
|    | 40282                    | PRODUŽETAK 1/2x10 mm                                                   | ART.447151  | 10 |
|                                                                                     | 40283                    | PRODUŽETAK 1/2x15 mm                                                   | ART.447168  | 10 |
|                                                                                     | 40284                    | PRODUŽETAK 1/2x20 mm                                                   | ART.447175  | 10 |
|                                                                                     | 40285                    | PRODUŽETAK 1/2x30 mm                                                   | ART.447199  | 10 |
|                                                                                     | 40286                    | PRODUŽETAK 1/2x50 mm                                                   | ART.447212  | 10 |
|                                                                                     | 0113041                  | PRODUŽETAK 3/4x10 mm                                                   | ART.447274  | 5  |
|                                                                                     | 0113037                  | PRODUŽETAK 3/4x15 mm                                                   | ART.447281  | 10 |
|                                                                                     | 0113038                  | PRODUŽETAK 3/4x20 mm                                                   | ART.447298  | 10 |
|                                                                                     | 0113039                  | PRODUŽETAK 3/4x30 mm                                                   | ART.447311  | 10 |
|                                                                                     | 0113040                  | PRODUŽETAK 3/4x50 mm                                                   | ART.447335  | 10 |
|    | 40424                    | NIPEL BRONCA KROMIRANO 1/4"                                            | ART.447885  | 5  |
|                                                                                     | 40425                    | NIPEL BRONCA KROMIRANO 3/8"                                            | ART.447892  | 5  |
|                                                                                     | 40426                    | NIPEL BRONCA KROMIRANO 1/2"                                            | ART.447908  | 5  |
|                                                                                     | 40427                    | NIPEL BRONCA KROMIRANO 3/4"                                            | ART.447915  | 5  |
|  | 40986                    | REDUKCIJA BRONCA KROMIRANO 3/8"-1/4"                                   | ART. 458867 | 10 |
|                                                                                     | 40429                    | REDUKCIJA BRONCA KROMIRANO 1/2"-1/4"                                   | ART. 458799 | 10 |
|                                                                                     | 40799                    | REDUKCIJA BRONCA KROMIRANO 1/2"-3/8"                                   | ART. 458874 | 10 |
|                                                                                     | 40431                    | REDUKCIJA BRONCA KROMIRANO 3/4"-3/8"                                   | ART. 458881 | 10 |
|                                                                                     | 40432                    | REDUKCIJA BRONCA KROMIRANO 3/4"-1/2"                                   | ART.448189  | 10 |
|                                                                                     | 0113055                  | REDUKCIJA BRONCA KROMIRANO 3/4"-3/4"                                   | ART.449346  | 5  |
|                                                                                     | 40428                    | REDUKCIJA MESING 3/8"-1/4"                                             | ART. 105273 | 10 |
|                                                                                     | 0623275                  | REDUKCIJA BRONCA 1"-3/4"                                               | ART.266547  | 10 |
| 0623276                                                                             | REDUKCIJA BRONCA 5/4"-1" | ART.269173                                                             | *           |    |
|  | 40138                    | REDUKCIJA BRONCA KROMIRANO 3/8"-1/4"<br>SA TERMIČKIM RASTEREČENJEM     | ART. 101701 | 10 |
|                                                                                     | 40785                    | REDUKCIJA BRONCA KROMIRANO 1/2"-3/8"                                   | ART. 447991 | 10 |
|                                                                                     | 0113054                  | REDUKCIJA BRONCA KROMIRANO 3/4"-1/2"                                   | ART. 448264 | 5  |
|                                                                                     | 40786                    | REDUKCIJA BRONCA KROMIRANO 1"-3/4"                                     | ART.448059  | 5  |
|  | 40436                    | REDUKCIJA BRONCA KROMIRANO<br>M-Ž 1/4"-3/8"                            | ART.448110  | 5  |
|                                                                                     | 40437                    | REDUKCIJA BRONCA KROMIRANO<br>M-Ž 3/8"-1/2"                            | ART.448127  | 10 |
|                                                                                     | 40438                    | REDUKCIJA BRONCA KROMIRANO<br>M-Ž 3/8"-3/4"                            | ART.448134  | 5  |
|                                                                                     | 40868                    | REDUKCIJA BRONCA KROMIRANO<br>M-Ž 1/2"-3/8"                            | ART.448141  | 5  |
|                                                                                     | 40440                    | REDUKCIJA BRONCA KROMIRANO<br>M-Ž 1/2"-3/4"                            | ART.448158  | 10 |
|                                                                                     | 40315                    | REDUKCIJA BRONCA KROMIRANO M-Ž 1/2"-3/4"<br>SA TERMIČKIM RASTEREČENJEM | ART.101763  | 10 |
|                                                                                     | 40441                    | REDUKCIJA BRONCA KROMIRANO M-Ž 3/4"-1"                                 | ART.448172  | 5  |
|                                                                                     | 40439                    | REDUKCIJA MESING M-Ž 1/2"-3/8"i                                        | ART.116217  | 10 |



**PRODUŽETCI, REDUKCIJE I SLIČNO OD BRONZE, PRESVUČENO KROMOM**

PAK M/V

|                                                                                     |         |                                                            |            |    |
|-------------------------------------------------------------------------------------|---------|------------------------------------------------------------|------------|----|
|    | 0113048 | TE KOMAD BRONCA KROMIRANO 3/8"                             | ART.114275 | 10 |
|                                                                                     | 40583   | TE KOMAD BRONCA KROMIRANO 1/2"                             | ART.105525 | 10 |
|                                                                                     | 0113049 | TE KOMAD BRONCA KROMIRANO 3/4"                             | ART.111762 | 5  |
|    | 40627   | PRIKLJUČAK BRONCA KROMIRANO Y                              | ART.106881 | 5  |
|    | 40632   | MUFNA 1/2" BRONCA KROMIRANO<br>MOGUĆNOST ZAVIJANJA KLJUČEM | ART.447762 | 5  |
|                                                                                     | 40582   | MUFNA 3/4" BRONCA KROMIRANO<br>MOGUĆNOST ZAVIJANJA KLJUČEM | ART.447779 | 5  |
|                                                                                     | 0113051 | MUFNA 1/8" MESING                                          | ART.441395 | 10 |
|                                                                                     | 0113052 | MUFNA 1/4" MESING                                          | ART.319137 | 10 |
|                                                                                     | 0623278 | MUFNA 3/4" MESING                                          | ART.266554 | 10 |
|                                                                                     | 0113053 | MUFNA 3/8" MESING                                          | ART.282349 | 10 |
|  | 0113036 | MUFNA 1/2" MESING                                          | ART.100957 | 25 |
|                                                                                     | 0113035 | MUFNA 6/4" BRONCA KROMIRANO                                | ART.106430 | 5  |
|  | 0113042 | KOLJENO BRONCA KROMIRANO ŽŽ 3/8"                           | ART.112639 | 10 |
|                                                                                     | 0626023 | KOLJENO MESING ŽŽ 3/8"                                     | ART.105471 | 25 |
|                                                                                     | 0113043 | KOLJENO BRONCA KROMIRANO ŽŽ 1/2"                           | ART.105600 | 10 |
|                                                                                     | 0113044 | KOLJENO BRONCA KROMIRANO ŽŽ 3/4"                           | ART.112141 | 10 |
|  | 0113045 | NIPL KOLJENO BRONCA KROMIRANO MŽ 3/8"                      | ART.106645 | 10 |
|                                                                                     | 0626024 | NIPL KOLJENO MESING MŽ 3/8"                                | ART.103828 | 25 |
|                                                                                     | 0113046 | NIPL KOLJENO BRONCA KROMIRANO MŽ 1/2"                      | ART.102586 | 10 |
|                                                                                     | 0113047 | NIPL KOLJENO BRONCA KROMIRANO MŽ 3/4"                      | ART.107758 | 5  |
|  | 40516   | NAVOJNA SPOJNICA KUTNA M-Ž 1/2"                            | ART.145804 | *  |
|  | 0113050 | KOLJENO BRONCA KROMIRANO<br>UNUTARNJI NAVOJ 1/2" 45°       | ART.320690 | 5  |

|                    |       |                |                                |                     |                     |
|--------------------|-------|----------------|--------------------------------|---------------------|---------------------|
| <p>PAK: 10 Kom</p> | H     | <b>0159001</b> | FLEX-CIJEV MATEU FIL-NOX       | M1/2-H1/2 30 cm     | ART.701030001/8204  |
|                    |       | <b>0159002</b> | FLEX-CIJEV MATEU FIL-NOX       | M1/2-H1/2 35 cm     | ART.701035001/8204  |
|                    |       | <b>0159003</b> | FLEX-CIJEV MATEU FIL-NOX       | M1/2-H1/2 40 cm     | ART.701040001/8204  |
|                    |       | <b>0159004</b> | FLEX-CIJEV MATEU FIL-NOX       | M1/2-H1/2 45 cm     | ART.701045001/8204  |
|                    |       | <b>0159005</b> | FLEX-CIJEV MATEU FIL-NOX       | M1/2-H1/2 50 cm     | ART.701050001/8204  |
|                    |       | <b>0159006</b> | FLEX-CIJEV MATEU FIL-NOX       | M1/2-H1/2 55 cm     | ART.701055001/8204  |
|                    |       | <b>0159007</b> | FLEX-CIJEV MATEU FIL-NOX       | M1/2-H1/2 60 cm     | ART.701060001/8204  |
|                    |       | <b>0159008</b> | FLEX-CIJEV MATEU FIL-NOX       | M1/2-H1/2 70 cm     | ART.701070001/8204  |
|                    |       | <b>0159009</b> | FLEX-CIJEV MATEU FIL-NOX       | M1/2-H1/2 80 cm     | ART.701080001/8204  |
|                    |       | <b>0159010</b> | FLEX-CIJEV MATEU FIL-NOX       | M1/2-H1/2 100 cm    | ART.701100001/8204  |
|                    |       | <b>0159031</b> | FLEX-CIJEV MATEU FIL-NOX       | M3/8-H3/8 10 cm     | ART.701010002/8204  |
|                    |       | <b>0159032</b> | FLEX-CIJEV MATEU FIL-NOX       | M3/8-H3/8 20 cm     | ART.701020002/8204  |
| <p>PAK: 10 Kom</p> | H     | <b>0159011</b> | FLEX-CIJEV MATEU FIL-NOX       | H1/2-H1/2 30 cm     | ART.701030005/8204  |
|                    |       | <b>0159012</b> | FLEX-CIJEV MATEU FIL-NOX       | H1/2-H1/2 40 cm     | ART.701040005/8204  |
|                    |       | <b>0159013</b> | FLEX-CIJEV MATEU FIL-NOX       | H3/8-H3/8 20 cm     | ART.701020006/8204  |
|                    |       | <b>0159014</b> | FLEX-CIJEV MATEU FIL-NOX       | H3/8-H3/8 30 cm     | ART.701030006/8204  |
|                    |       | <b>0159015</b> | FLEX-CIJEV MATEU FIL-NOX       | H3/8-H3/8 40 cm     | ART.701040006/8204  |
|                    |       | <b>0159016</b> | FLEX-CIJEV MATEU FIL-NOX       | H3/8-H3/8 60 cm     | ART.701060006/8204  |
|                    |       | <b>0159017</b> | FLEX-CIJEV MATEU FIL-NOX       | H3/8-H3/8 80 cm     | ART.701080006/8204  |
|                    |       | <b>0159018</b> | FLEX-CIJEV MATEU FIL-NOX       | H3/8-H3/8 100 cm    | ART.701100006/8204  |
| <p>PAK: 10 Kom</p> | H     | <b>0159019</b> | FLEX-CIJEV MATEU FIL-NOX       | H3/8-H1/2 30 cm     | ART.701030007/8204  |
|                    |       | <b>0159020</b> | FLEX-CIJEV MATEU FIL-NOX       | H3/8-H1/2 40 cm     | ART.701040007/8204  |
| <p>PAK: 10 Kom</p> | M10x1 | <b>0159021</b> | FLEX-CIJEV MATEU FIL-NOX GR    | M10x1x35-H3/8 35 cm | ART.7210350919/8024 |
| <p>PAK: 10 Kom</p> | H     | <b>0159036</b> | FLEX-CIJEV MATEU LUX UKRASNA   | H3/8-H3/8 20 cm     | ART.AQB020006       |
|                    |       | <b>0159037</b> | FLEX-CIJEV MATEU LUX UKRASNA   | H3/8-H3/8 25 cm     | ART.AQB025006       |
|                    |       | <b>0159038</b> | FLEX-CIJEV MATEU LUX UKRASNA   | H3/8-H3/8 30 cm     | ART.AQB030006       |
|                    | M     | <b>0159039</b> | FLEX-CIJEV ZA PLIN FIL GAS GIG | M3/4-H3/4 100 cm    | ART.009100026-B/Am  |
|                    | H     | <b>0159040</b> | FLEX-CIJEV ZA PLIN FIL GAS GIG | H3/4-H3/4 100 cm    | ART.009100029-B/Am  |



|                                                                                                        |         |                                              |                     |
|--------------------------------------------------------------------------------------------------------|---------|----------------------------------------------|---------------------|
| <br>H H<br>PAK: 5 Kom | 0159022 | FLEX-CIJEV MATEU FIL-NOX GIG H3/4-H3/4 30 cm | ART.705030029-B/R-A |
|                                                                                                        | 0159033 | FLEX-CIJEV MATEU FIL-BOR H1-H1 60 cm         | ART.704060041-B/R-A |
| <br>H M<br>PAK: 5 Kom | 0159023 | FLEX-CIJEV MATEU FIL-NOX GIG M3/4-H3/4 30 cm | ART.705030026-B/R-A |
|                                                                                                        | 0159034 | FLEX-CIJEV MATEU FIL-BOR M1-H1 60 cm         | ART.704060037-B/R-A |
| <br>C H<br>PAK: 5 Kom | 0159024 | FLEX-CIJEV MATEU FIL-NOX GIG H3/4-C3/4 30 cm | ART.705030021-B/R-A |
|                                                                                                        | 0159035 | FLEX-CIJEV MATEU FIL-BOR H1 -C1 40 cm        | ART.704040046-B/R-A |
|                                                                                                        | 0159086 | FLEX-CIJEV MATEU FIL-BOR H1-C1 60 cm         | ART.704060046-B/R-A |
| <br>C<br>PAK: 5 Kom  | 0159025 | FLEX-CIJEV MATEU FIL-NOX GIG M3/4-C3/4 30 cm | ART.705030034-B/R-A |
|                                                                                                        | 0159043 | FLEX-CIJEV MATEU FIL-BOR M1 -C1 40 cm        | ART.704040045-B/R-A |
|                                                                                                        | 0159044 | FLEX-CIJEV MATEU FIL-BOR M1-C1 60 cm         | ART.704060045-B/R-A |

|                                                                                                   |         |                                                                      |                           |
|---------------------------------------------------------------------------------------------------|---------|----------------------------------------------------------------------|---------------------------|
| <br>PAK: 1 Kom | 0159027 | CRIJEVO FLEXIBILNO RASTEZLJIVO OD 150 DO 190 cm                      | ART.FLE150300             |
| <br>PAK: 1 Kom | 0159030 | PRIKLJUČNO CRIJEVO ZA VEŠ MAŠINU 150 cm                              | ART.CLA201001             |
| <br>PAK: 1 Kom | 0159041 | RASTEZLJIVO ODVODNO CRIJEVO ZA VEŠ MAŠINU I PERILICU OD 60 DO 200 cm | ART.DLA060002             |
| <br>PAK: 1 Kom | 0159026 | TUŠ CRIJEVO 120cm S PREKIDAČ RUČICOM CROM                            | ART.AQA004003 (AQA004006) |

|                                                                                    |                |                                     |                   |               |
|------------------------------------------------------------------------------------|----------------|-------------------------------------|-------------------|---------------|
|  | <b>0159072</b> | FLEX-CIJEV MATEU FIL-NOX ZA SLAVINE | M8x18-H3/8 30 cm  | ART.721030093 |
|                                                                                    | <b>0159073</b> | FLEX-CIJEV MATEU FIL-NOX ZA SLAVINE | M8x18-H3/8 40 cm  | ART.721040093 |
|                                                                                    | <b>0159074</b> | FLEX-CIJEV MATEU FIL-NOX ZA SLAVINE | M8x18-H3/8 50 cm  | ART.721050093 |
|                                                                                    | <b>0159075</b> | FLEX-CIJEV MATEU FIL-NOX ZA SLAVINE | M8x18-H3/8 60 cm  | ART.721060093 |
|                                                                                    | <b>0159068</b> | FLEX-CIJEV MATEU FIL-NOX ZA SLAVINE | M8x18-H1/2 30 cm  | ART.721030088 |
|                                                                                    | <b>0159069</b> | FLEX-CIJEV MATEU FIL-NOX ZA SLAVINE | M8x18-H1/2 40 cm  | ART.721040088 |
|                                                                                    | <b>0159070</b> | FLEX-CIJEV MATEU FIL-NOX ZA SLAVINE | M8x18-H1/2 50 cm  | ART.721050088 |
|                                                                                    | <b>0159071</b> | FLEX-CIJEV MATEU FIL-NOX ZA SLAVINE | M8x18-H1/2 60 cm  | ART.721060088 |
|                                                                                    | <b>0159050</b> | FLEX-CIJEV MATEU FIL-NOX ZA SLAVINE | M10x18-H3/8 30 cm | ART.721030090 |
|                                                                                    | <b>0159051</b> | FLEX-CIJEV MATEU FIL-NOX ZA SLAVINE | M10x18-H3/8 40 cm | ART.721040090 |
|                                                                                    | <b>0159052</b> | FLEX-CIJEV MATEU FIL-NOX ZA SLAVINE | M10x18-H3/8 50 cm | ART.721050090 |
|                                                                                    | <b>0159053</b> | FLEX-CIJEV MATEU FIL-NOX ZA SLAVINE | M10x18-H3/8 60 cm | ART.721060090 |
|                                                                                    | <b>0159054</b> | FLEX-CIJEV MATEU FIL-NOX ZA SLAVINE | M10x18-H3/8 70 cm | ART.721070090 |
|                                                                                    | <b>0159045</b> | FLEX-CIJEV MATEU FIL-NOX ZA SLAVINE | M10x18-H1/2 30 cm | ART.721030085 |
|                                                                                    | <b>0159046</b> | FLEX-CIJEV MATEU FIL-NOX ZA SLAVINE | M10x18-H1/2 40 cm | ART.721040085 |
|                                                                                    | <b>0159047</b> | FLEX-CIJEV MATEU FIL-NOX ZA SLAVINE | M10x18-H1/2 50 cm | ART.721050085 |
|                                                                                    | <b>0159048</b> | FLEX-CIJEV MATEU FIL-NOX ZA SLAVINE | M10x18-H1/2 60 cm | ART.721060085 |
|                                                                                    | <b>0159049</b> | FLEX-CIJEV MATEU FIL-NOX ZA SLAVINE | M10x18-H1/2 70 cm | ART.721070085 |
|                                                                                    | <b>0159055</b> | FLEX-CIJEV MATEU FIL-NOX ZA SLAVINE | M10x35-H1/2 30 cm | ART.721030086 |
|                                                                                    | <b>0159056</b> | FLEX-CIJEV MATEU FIL-NOX ZA SLAVINE | M10x35-H1/2 40 cm | ART.721040086 |
|                                                                                    | <b>0159057</b> | FLEX-CIJEV MATEU FIL-NOX ZA SLAVINE | M10x35-H1/2 50 cm | ART.721050086 |
|                                                                                    | <b>0159058</b> | FLEX-CIJEV MATEU FIL-NOX ZA SLAVINE | M10x35-H1/2 60 cm | ART.721060086 |
|                                                                                    | <b>0159059</b> | FLEX-CIJEV MATEU FIL-NOX ZA SLAVINE | M10x35-H1/2 70 cm | ART.721070086 |
|                                                                                    | <b>0159060</b> | FLEX-CIJEV MATEU FIL-NOX ZA SLAVINE | M10x50-H3/8 30 cm | ART.721030092 |
|                                                                                    | <b>0159061</b> | FLEX-CIJEV MATEU FIL-NOX ZA SLAVINE | M10x50-H3/8 40 cm | ART.721040092 |
|                                                                                    | <b>0159062</b> | FLEX-CIJEV MATEU FIL-NOX ZA SLAVINE | M10x50-H3/8 50 cm | ART.721050092 |
|                                                                                    | <b>0159063</b> | FLEX-CIJEV MATEU FIL-NOX ZA SLAVINE | M10x50-H3/8 60 cm | ART.721060092 |
|                                                                                    | <b>0159064</b> | FLEX-CIJEV MATEU FIL-NOX ZA SLAVINE | M10x50-H1/2 30 cm | ART.721030087 |
|                                                                                    | <b>0159065</b> | FLEX-CIJEV MATEU FIL-NOX ZA SLAVINE | M10x50-H1/2 40 cm | ART.721040087 |
|                                                                                    | <b>0159066</b> | FLEX-CIJEV MATEU FIL-NOX ZA SLAVINE | M10x50-H1/2 50 cm | ART.721050087 |
|                                                                                    | <b>0159067</b> | FLEX-CIJEV MATEU FIL-NOX ZA SLAVINE | M10x50-H1/2 60 cm | ART.721060087 |

|  |   |                |                                               |                 |                     |
|--|---|----------------|-----------------------------------------------|-----------------|---------------------|
|  | H | <b>0159080</b> | FLEX-CIJEV MATEU FIL-NOX S NASTAVKOM ZA KLJUČ | M1/2-H1/2 30 cm | ART.701030001/8204A |
|  |   | <b>0159081</b> | FLEX-CIJEV MATEU FIL-NOX S NASTAVKOM ZA KLJUČ | M1/2-H1/2 35 cm | ART.701035001/8204A |
|  |   | <b>0159082</b> | FLEX-CIJEV MATEU FIL-NOX S NASTAVKOM ZA KLJUČ | M1/2-H1/2 40 cm | ART.701040001/8204A |
|  |   | <b>0159083</b> | FLEX-CIJEV MATEU FIL-NOX S NASTAVKOM ZA KLJUČ | M1/2-H1/2 45 cm | ART.701045001/8204A |
|  | M | <b>0159085</b> | FLEX-CIJEV MATEU FIL-NOX S NASTAVKOM ZA KLJUČ | M1/2-H1/2 50 cm | ART.701050001/8204A |
|  |   | <b>0159084</b> | ROZETA ŠESTEROKUTA ZA FLEX CIJEVI             |                 | ART.FLO35002        |
|  |   | <b>0159076</b> | ŠTEDNI PERLATOR ZA UMIVAONIK                  |                 | ART.AQA500001       |
|  |   | <b>0159077</b> | ŠTEDNI PERLATOR ZA KUHINJU                    |                 | ART.AQA500002       |
|  |   | <b>0159078</b> | ŠTEDNI SET 2 PERLATORA+KLJUČ                  |                 | ART.AQA500003       |
|  |   | <b>0159079</b> | NASTAVAK ZA TUŠ CRIJEVO ZA UŠTEDU VODE        |                 | ART.AQA500004       |



|                                                                                     |                     |                                |              |              |        |                 |
|-------------------------------------------------------------------------------------|---------------------|--------------------------------|--------------|--------------|--------|-----------------|
|    | <b>0114024</b>      | CRIJEVO FLEKSIBILNO            | 3/8"-3/8"    | MŽ           | 20 cm  | kom.            |
|                                                                                     | <b>0114020</b>      | CRIJEVO FLEKSIBILNO            | 1/2"-1/2"    | MŽ           | 30 cm  | kom.            |
|                                                                                     | <b>11084</b>        | CRIJEVO FLEKSIBILNO            | 1/2"-1/2"    | MŽ           | 35 cm  | kom.            |
|                                                                                     | <b>11075</b>        | CRIJEVO FLEKSIBILNO            | 1/2"-1/2"    | MŽ           | 40 cm  | kom.            |
|                                                                                     | <b>11028</b>        | CRIJEVO FLEKSIBILNO            | 1/2"-1/2"    | MŽ           | 45 cm  | kom.            |
|                                                                                     | <b>11136</b>        | CRIJEVO FLEKSIBILNO            | 1/2"-1/2"    | MŽ           | 50 cm  | kom.            |
|                                                                                     | <b>11825</b>        | CRIJEVO FLEKSIBILNO            | 1/2"-1/2"    | MŽ           | 55 cm  | kom.            |
|                                                                                     | <b>12847</b>        | CRIJEVO FLEKSIBILNO            | 1/2"-1/2"    | MŽ           | 60 cm  | kom.            |
|                                                                                     | <b>0114023</b>      | CRIJEVO FLEKSIBILNO            | 1/2"-1/2"    | MŽ           | 80 cm  | kom.            |
|                                                                                     | <b>0114021</b>      | CRIJEVO FLEKSIBILNO            | 1/2"-1/2"    | MŽ           | 100 cm | kom.            |
|                                                                                     | <b>0114025</b>      | CRIJEVO FLEKSIBILNO            | 3/8"-1/2"    | MŽ           | 30 cm  | kom.            |
|                                                                                     | <b>77019</b>        | CRIJEVO FLEKSIBILNO            | 1/2"-1/2"    | ŽŽ           | 30 cm  | kom.            |
|                                                                                     | <b>77020</b>        | CRIJEVO FLEKSIBILNO            | 1/2"-1/2"    | ŽŽ           | 35 cm  | kom.            |
|                                                                                     | <b>77023</b>        | CRIJEVO FLEKSIBILNO            | 1/2"-1/2"    | ŽŽ           | 40 cm  | kom.            |
|                                                                                     | <b>77021</b>        | CRIJEVO FLEKSIBILNO            | 1/2"-1/2"    | ŽŽ           | 50 cm  | kom.            |
|                                                                                     | <b>77022</b>        | CRIJEVO FLEKSIBILNO            | 1/2"-1/2"    | ŽŽ           | 60 cm  | kom.            |
|                                                                                     | <b>11913</b>        | CRIJEVO FLEKSIBILNO            | 3/8"-3/8"    | ŽŽ           | 30 cm  | kom.            |
|                                                                                     | <b>12006</b>        | CRIJEVO FLEKSIBILNO            | 3/8"-3/8"    | ŽŽ           | 40 cm  | kom.            |
|                                                                                     | <b>0114022</b>      | CRIJEVO FLEKSIBILNO            | 3/8"-3/8"    | ŽŽ           | 50 cm  | kom.            |
|                                                                                     | <b>12432</b>        | CRIJEVO FLEKSIBILNO            | 3/8"-3/8"    | ŽŽ           | 60 cm  | kom.            |
| <b>12401</b>                                                                        | CRIJEVO FLEKSIBILNO | 3/8"-3/8"                      | ŽŽ           | 80 cm        | kom.   |                 |
| <b>12389</b>                                                                        | CRIJEVO FLEKSIBILNO | 3/8"-3/8"                      | ŽŽ           | 100 cm       | kom.   |                 |
| <b>11137</b>                                                                        | CRIJEVO FLEKSIBILNO | 3/8"-1/2"                      | ŽŽ           | 30 cm        | kom.   |                 |
| <b>11146</b>                                                                        | CRIJEVO FLEKSIBILNO | 3/8"-1/2"                      | ŽŽ           | 40 cm        | kom.   |                 |
|  | <b>0114026</b>      | CIJEV ZA BOJLER INOX S ROZETOM | 30 cm        | DN10 ECOFLEX |        | ART.10104       |
|                                                                                     | <b>0114027</b>      | CIJEV ZA BOJLER INOX S ROZETOM | 35 cm        | DN10 ECOFLEX |        | ART.10106       |
|                                                                                     | <b>0114028</b>      | CIJEV ZA BOJLER INOX S ROZETOM | 40 cm        | DN10 ECOFLEX |        | ART.10108       |
|                                                                                     | <b>0114029</b>      | CIJEV ZA BOJLER INOX S ROZETOM | 45 cm        | DN10 ECOFLEX |        | ART.10110       |
|                                                                                     | <b>0114030</b>      | CIJEV ZA BOJLER INOX S ROZETOM | 50 cm        | DN10 ECOFLEX |        | ART.10112       |
|  | <b>90284</b>        | CRIJEVO ZA SLAVINE FLEKSIBILNO | 10Mx3/8F     | l=45         |        | ART.10810D38F45 |
|                                                                                     | <b>90285</b>        | CRIJEVO ZA SLAVINE FLEKSIBILNO | 10Mx3/8F     | l=60         |        | ART.10810D38F60 |
|                                                                                     | <b>90286</b>        | CRIJEVO ZA SLAVINE FLEKSIBILNO | 10Mx3/8F     | l=90         |        | ART.10810D38F90 |
|  | <b>11108</b>        | CIJEV U KOLUTU KROMIRANA       | Ø 12         | l = 5 m      |        | ART.111 12      |
|                                                                                     | <b>11062</b>        | CIJEV U KOLUTU KROMIRANA       | Ø 10         | l = 5 m      |        | ART.111 10      |
|  | <b>11112</b>        | CIJEV ZA MALI BOJLER KROMIRANA | Ø 10 x 1/2"  | L=50 cm      |        | ART.1141250     |
|  | <b>11912</b>        | SPOJNICA KROMIRANA             | 3/8M x 10 mm |              |        | ART.1253810     |
|                                                                                     | <b>11202</b>        | SPOJNICA KROMIRANA             | 1/2M x 10 mm |              |        | ART.1251210     |

|                                                                                     |                |                                                 |                |
|-------------------------------------------------------------------------------------|----------------|-------------------------------------------------|----------------|
|    | <b>11076</b>   | SPOJNICA KROMIRANA 3/8Mx10x10mm                 | ART.125D       |
|    | <b>11145</b>   | SPOJNICA KROMIRANA 1/2Fx10mm                    | ART.125F       |
|    | <b>90190</b>   | PRODUŽETAK KROMIRANI ZA SIFONE Ø 32             | ART.15332      |
|    | <b>90189</b>   | PRODUŽETAK KROMIRANI 3/4Mx3/4F                  | ART.258RA      |
|    | <b>90191</b>   | PRODUŽETAK KROMIRANI FLEKSIBILNI ZA SIFONE Ø 32 | ART.1553230    |
|    | <b>90152</b>   | ČEP S ROZETOM                                   | ART.14212      |
|    | <b>90283</b>   | KROMIRANA CIJEV Ø 10 mm x 100 cm                | ART.111 10 100 |
|  | <b>90150</b>   | OBUJMICA METALNA 1/2" - IZLAZ 1/2"              | ART.64412      |
|                                                                                     | <b>90151</b>   | OBUJMICA METALNA 3/4" - IZLAZ 1/2"              | ART.64434      |
|                                                                                     | <b>90589</b>   | OBUJMICA METALNA 1" - IZLAZ 3/4"                | ART.64410      |
|                                                                                     | <b>90590</b>   | OBUJMICA METALNA 5/4" - IZLAZ 3/4"              | ART.644114     |
|                                                                                     | <b>90591</b>   | OBUJMICA METALNA 6/4" - IZLAZ 3/4"              | ART.644112     |
|  | <b>1117001</b> | ROZETA NIKLOVANA 1/2                            | ART.631        |
|  | <b>1117002</b> | ROZETA SA JEZIČKOM NIKLOVANA                    | ART.632RF      |
|  | <b>1117003</b> | ROZETA ZA SIFONE NIKLOVANA Ø 32,5               | ART.621K       |
|  | <b>1117004</b> | ROZETA ZA BATERIJE NIKLOVANA                    | ART.612K       |
|  | <b>1117005</b> | ROZETA ZA RADIJATORE BIJELA Ø 15                | ART.520P       |
|  | <b>1117006</b> | ROZETA ZA RADIJATORE CROM                       | ART.511K       |
|  | <b>1117014</b> | UKRASNA NIKLOVANA REŠETKA 150x150               | ART.711        |
|  | <b>1117009</b> | CIJEV ZA SIFON Ø 32 x 300 CROM                  | ART.9010K      |

|                                                                                                                                                                                                                                                                                                                                                                                                                                                                                                                                                                                                                                                                                                                                                           |                                                                                                                                                                                                                                                                                                                                                                                                                                                                                                                                                                                               |
|-----------------------------------------------------------------------------------------------------------------------------------------------------------------------------------------------------------------------------------------------------------------------------------------------------------------------------------------------------------------------------------------------------------------------------------------------------------------------------------------------------------------------------------------------------------------------------------------------------------------------------------------------------------------------------------------------------------------------------------------------------------|-----------------------------------------------------------------------------------------------------------------------------------------------------------------------------------------------------------------------------------------------------------------------------------------------------------------------------------------------------------------------------------------------------------------------------------------------------------------------------------------------------------------------------------------------------------------------------------------------|
|  <p>Brtvljenje metalnih i plastičnih cijevnih navoja. Zamjena za kudelju, paste i PTFE traku. Za navoje do R6. Ne stvrdnjava, trenutno brtvi na puni pritisak.</p> <ul style="list-style-type: none"> <li>* DVGW odobrenje za plin i vodu (EN 751-1): DV-5142AU 0166</li> <li>* EN 751-2 klasa ARp i DIN 30660</li> <li>* KTW Odobrenje za pitku vodu</li> <li>* WRC odobrenje za upotrebu u sustavima za pitku vodu do 85 °C (BS 6920)</li> <li>* Certificirano od NSF/ ANSI, Standard 61</li> </ul> <p><b>0526157</b> TEFLONSKA NIT ZA BRTVLJENJE<br/>LOCTITE 55 150 m ART.252831</p> <p><b>0526158</b> TEFLONSKA NIT ZA BRTVLJENJE<br/>LOCTITE 55 50 m ART.483292</p> |  <p>Tekuće brtvilo za cijevne navoje za navoje do R3 (M80). Prikladan za brzu aplikaciju pri niskim temperaturama. Dozvoljava rastavljanje standardnim ručnim alatom.</p> <ul style="list-style-type: none"> <li>* DVGW odobrenje (EN 751-1): NG-5146AR0621</li> <li>* WRC odobrenje za upotrebu u sustavima za pitku vodu do 85 °C (BS 6920)</li> <li>* BAM odobrenje za upotrebu u sustavima s kisikom do 15 bara i +60 °C</li> </ul> <p><b>0526159</b> TEKUĆI TEFLON<br/>LOCTITE 577 50 ml ART.142454</p> |
|  <p><b>11123</b> SAPUN ZA MONTAŽU GEBERIT ART.677184</p>                                                                                                                                                                                                                                                                                                                                                                                                                                                                                                                                                                                                                 |  <p><b>11055</b> KUDELJA FINA<br/>JEDINICA MJERE: Kg ART.570</p>                                                                                                                                                                                                                                                                                                                                                                                                                                           |
|  <p><b>11159</b> FILC OBIČNI 30/1</p>                                                                                                                                                                                                                                                                                                                                                                                                                                                                                                                                                                                                                                    |  <p><b>0721066</b> TRAKA SAMOLJEPLJIVA<br/>50mm x3mm 15m ART.3601</p>                                                                                                                                                                                                                                                                                                                                                                                                                                      |
|  <p><b>11125</b> DEKORODAL TRAKA 10 cm<br/>SAMOLJEP. ART.843059</p>                                                                                                                                                                                                                                                                                                                                                                                                                                                                                                                                                                                                    |  <p><b>0626030</b> TRAKA ALUMINIJSKA WURTH 5 cm x 100 m</p>                                                                                                                                                                                                                                                                                                                                                                                                                                              |
|  <p><b>0222001</b> PASTA ZA KUDELJU LOCHER 250 g V901.1<br/>LOCHER PASTE 2000</p>                                                                                                                                                                                                                                                                                                                                                                                                                                                                                                                                                                                      |  <p><b>12386</b> GUMA PODLOŽNA ZA WC ŠKOLJKU</p>                                                                                                                                                                                                                                                                                                                                                                                                                                                         |
|  <p><b>0222002</b> PASTA ZA KUDELJU LOCHER 400 g V901.1<br/>LOCHER PASTE 2000</p>                                                                                                                                                                                                                                                                                                                                                                                                                                                                                                                                                                                      |  <p><b>90388</b> MEKI LOT 250 g WURTH SN97/CU3 D 3 mm</p>                                                                                                                                                                                                                                                                                                                                                                                                                                                |
|  <p><b>0222003</b> GEL TEKUĆI ZA PVC SPOJEVE LOCHER 500 ml<br/>V960.1 LOCHER SPEZIAL-GLEITMITTEL</p>                                                                                                                                                                                                                                                                                                                                                                                                                                                                                                                                                                   |  <p><b>90612</b> CIJEVNA IZOLACIJA BIJELA 1/2 25/1<br/><b>90613</b> CIJEVNA IZOLACIJA BIJELA 3/4 25/1</p>                                                                                                                                                                                                                                                                                                                                                                                                |



|                |                                  |        |
|----------------|----------------------------------|--------|
| <b>12250</b>   | BRTVA ZA PLIN I CIJEVI FLEX.     | 1/2"   |
| <b>0302007</b> | BRTVA ZA CIJEVI FLEX.            | 1/2"   |
| <b>90051</b>   | BRTVA ZA BATERIJU I CIJEVI FLEX. | 3/4"   |
| <b>12475</b>   | BRTVA ZA CIJEVI FLEX.            | 3/8"   |
| <b>12297</b>   | BRTVA GUMENA ZA HOLENDER         | 1/2"   |
| <b>12298</b>   | BRTVA GUMENA ZA HOLENDER         | 3/4"   |
| <b>12299</b>   | BRTVA GUMENA ZA HOLENDER         | 1"     |
| <b>12300</b>   | BRTVA GUMENA ZA HOLENDER         | 1 1/4" |
| <b>12301</b>   | BRTVA GUMENA ZA HOLENDER         | 1 1/2" |
| <b>12302</b>   | BRTVA GUMENA ZA HOLENDER         | 2"     |
| <b>12590</b>   | BRTVA GUMENA ZA HOLENDER         | 2 1/2" |
| <b>12584</b>   | BRTVA GUMENA ZA HOLENDER         | 3"     |



|              |                                           |           |
|--------------|-------------------------------------------|-----------|
| <b>11735</b> | BRTVA KLINGERIT ZA HOLENDER<br>ART.720230 | 1/2"      |
| <b>11736</b> | BRTVA KLINGERIT ZA HOLENDER<br>ART.720232 | 3/4"      |
| <b>11737</b> | BRTVA KLINGERIT ZA HOLENDER<br>ART.720233 | 1"        |
| <b>11738</b> | BRTVA KLINGERIT ZA HOLENDER<br>ART.720234 | 5/4"      |
| <b>11739</b> | BRTVA KLINGERIT ZA HOLENDER<br>ART.720236 | 6/4"      |
| <b>11740</b> | BRTVA KLINGERIT ZA HOLENDER<br>ART.720244 | 2"        |
| <b>11741</b> | BRTVA KLINGERIT ZA HOLENDER<br>ART.720292 | 2 1/2"    |
| <b>11742</b> | BRTVA KLINGERIT ZA HOLENDER<br>ART.720290 | 3"        |
| <b>11180</b> | BRTVA KLINGERIT<br>ART.720214             | 1/2" 10/1 |
| <b>11181</b> | BRTVA KLINGERIT<br>ART.720212             | 3/8" 10/1 |



|              |                                              |           |
|--------------|----------------------------------------------|-----------|
| <b>12368</b> | VIJCI S TIPLOM Ø 6                           | SET: 30/1 |
| <b>12369</b> | VIJCI S TIPLOM Ø 8                           | SET: 20/1 |
| <b>12370</b> | VIJCI S TIPLOM Ø 10                          | SET: 20/1 |
| <b>12371</b> | VIJCI S TIPLOM Ø 12                          | SET: 10/1 |
| <b>12372</b> | VIJCI S TIPLOM Ø 8 "UNI"<br>ZA ŠUPLJU CIGLU  | SET: 10/1 |
| <b>12373</b> | VIJCI S TIPLOM Ø 10 "UNI"<br>ZA ŠUPLJU CIGLU | SET: 5/1  |



|              |                      |           |
|--------------|----------------------|-----------|
| <b>12295</b> | BRTVE ZA DOMAĆINSTVO | SET: 30/1 |
| <b>12296</b> | BRTVE ZA DOMAĆINSTVO | SET: 20/1 |

|                                                                                     |                                                                                                              |                                                                                                                                                                                                                                        |
|-------------------------------------------------------------------------------------|--------------------------------------------------------------------------------------------------------------|----------------------------------------------------------------------------------------------------------------------------------------------------------------------------------------------------------------------------------------|
|    | <b>14100</b><br><b>14101</b><br><b>14021</b><br><b>14022</b><br><b>14020</b><br><b>14056</b><br><b>14057</b> | GP LABIRINT BRTVA Ø 32 SEGEDI<br>GP LABIRINT BRTVA Ø 40 SEGEDI<br>GP LABIRINT BRTVA Ø 50 SEGEDI<br>GP LABIRINT BRTVA Ø 75 SEGEDI<br>GP LABIRINT BRTVA Ø 110 SEGEDI<br>GP LABIRINT BRTVA Ø 125 SEGEDI<br>GP LABIRINT BRTVA Ø 160 SEGEDI |
|    | <b>68015</b><br><br><b>0203088</b>                                                                           | BRTVA ZA PISOAR 35x14 SEGEDI<br><br>BRTVA ZA PISOAR 35x19 SEGEDI                                                                                                                                                                       |
|   | <b>0203107</b><br><b>0203112</b><br><b>14065</b><br><b>14058</b>                                             | SIFONSKA BRTVA 40x32 SEGEDI<br>SIFONSKA BRTVA 52x25 SEGEDI<br>SIFONSKA BRTVA 50x32 SEGEDI<br>SIFONSKA BRTVA 50x40 SEGEDI                                                                                                               |
|  | <b>0203086</b>                                                                                               | SIFONSKA BRTVA ZA WC ŠKOLJKU 52x44 SEGEDI                                                                                                                                                                                              |
|  | <b>90187</b>                                                                                                 | DOVODNO CRIJEVO ZA PERILICU 150cm      ART.291150                                                                                                                                                                                      |
|  | <b>90188</b>                                                                                                 | ODVODNO CRIJEVO ZA PERILICU 150cm      ART.306150                                                                                                                                                                                      |
|  | <b>21032</b>                                                                                                 | WC PRIKLJUČAK RAVNI fi 110 CRNI      ART.689                                                                                                                                                                                           |
|  | <b>90168</b>                                                                                                 | BRTVA SET OD 430 kom/12 VELIČINA      ART.648                                                                                                                                                                                          |



|                                                                                     |                |                                                    |
|-------------------------------------------------------------------------------------|----------------|----------------------------------------------------|
|    | <b>12600</b>   | VIJAK Ø 8 S TIPLOM Ø 12 ZA DRŽAČ                   |
|    | <b>12031</b>   | VIJCI ZA UMIVAONIK PAR 2/1 10 cm                   |
|    | <b>12007</b>   | VIJCI ZA WC ŠKOLJKU I BIDE PAR 2/1 9 cm            |
|   | <b>12975</b>   | VIJCI ZA WC ŠKOLJKU I BIDE INOX PAR 2/1 9 cm       |
|  | <b>0203113</b> | VIJCI ZA VALENTINU, MAJORU SEGEDI                  |
|  | <b>12369</b>   | VIJCI S TIPLOM Ø 8 SET.20/1 SEGEDI                 |
|  | <b>12372</b>   | VIJCI S TIPLOM Ø 8 SET.10/1 ZA ŠUPLJU CIGLU SEGEDI |
|  | <b>12370</b>   | VIJCI S TIPLOM Ø 10 SET.20/1 SEGEDI                |

|                                                                                                                                                                    |                                                                                                                                                                                 |                                                                                                                                                                                                       |
|--------------------------------------------------------------------------------------------------------------------------------------------------------------------|---------------------------------------------------------------------------------------------------------------------------------------------------------------------------------|-------------------------------------------------------------------------------------------------------------------------------------------------------------------------------------------------------|
|  <p><b>12975</b> VIJCI ZA WC ŠKOLJKU I BIDE INOX PAR 2/1 9 cm</p>                 |  <p><b>12031</b> VIJCI ZA UMIVAONIK PAR 2/1 10 cm</p>                                          |  <p><b>12029</b> VIJCI ZA UMIVAONIK PAR 2/1 WST 10x140 ART.80660 FISCHER</p>                                       |
|  <p><b>12007</b> VIJCI ZA WC ŠKOLJKU I BIDE PAR 2/1 9 cm</p>                     |  <p><b>12128</b> VIJCI ZA WC ŠKOLJKU I BIDE PAR 2/1 8,5 cm S8RD80 FISCHER ART.60568 (PAR)</p> |  <p><b>12127</b> VIJCI ZA WC ŠKOLJKU 6,5 cm PAR 2/1 S8RD60 FISCHER ART.60570</p>                                  |
|  <p><b>12030</b> VIJCI ZA WC ŠKOLJKU PAR 2/1 7cm S8D70WCR FISCHER ART.60564</p> |  <p><b>12269</b> VIJCI ZA BOJLER SET 4/1 10 cm</p>                                           |  <p><b>11223</b> VIJCI KUKASTI 7,5 cm PAR ART.75575<br/><b>90172</b> VIJCI KUKASTI 10cm PAR REMER ART.755100</p> |
|  <p><b>68012</b> VIJCI ZA VALENTINU, MAJORU I SL. ART.1802C</p>                 |                                                                                                                                                                                 |                                                                                                                                                                                                       |

## KADE, TUŠ KADE I ČUČAVCI EMAJLIRANI

|                                                                                     |                                                                  |                                                                                                                                                                                          |
|-------------------------------------------------------------------------------------|------------------------------------------------------------------|------------------------------------------------------------------------------------------------------------------------------------------------------------------------------------------|
|    | <p>06004</p> <p>06005</p> <p>06055</p> <p>06006</p> <p>06054</p> | <p>KADA EMAJLIRANA 120 cm BIJELA</p> <p>KADA EMAJLIRANA 140 cm BIJELA</p> <p>KADA EMAJLIRANA 150 cm BIJELA</p> <p>KADA EMAJLIRANA 160 cm BIJELA</p> <p>KADA EMAJLIRANA 170 cm BIJELA</p> |
|    | <p>21083</p> <p>06001</p> <p>06017</p>                           | <p>TUŠ KADA EMAJLIRANA 70x70/12 BIJELA</p> <p>TUŠ KADA EMAJLIRANA 80x80/8 BIJELA</p> <p>TUŠ KADA EMAJLIRANA 80x80/16 BIJELA</p>                                                          |
|  | <p>11001</p> <p>11038</p> <p>22020</p> <p>10017</p>              | <p>ČUČAVAC EMAJLIRANI BIJELI</p> <p>USMJERIVAČ-PAPUČICA ZA ČUČAVAC</p> <p>SIFON ZA ČUČAVAC BIJELI 1209</p> <p>SIFON ZA ČUČAVAC SIVI S GUMOM</p>                                          |

|                                                                                     |                           |                                                                                      |
|-------------------------------------------------------------------------------------|---------------------------|--------------------------------------------------------------------------------------|
|  | <p>21071</p>              | <p>UMIVAONIK KUTNI SALLY BIJELO 46 cm</p>                                            |
|  | <p>11160</p> <p>21076</p> | <p>WC ČUČAVAC KERAMIČKI MONA BIJELO</p> <p>WC ČUČAVAC KERAMIČKI LOBNA PRAVOKUTNI</p> |

|                                                                                     |                            |                                                      |              |
|-------------------------------------------------------------------------------------|----------------------------|------------------------------------------------------|--------------|
|    | <b>0301085</b>             | UDARNO TIPLO PVC 5x35 MEA cod.960591                 | ART.501501   |
|                                                                                     | <b>0301026</b>             | UDARNO TIPLO PVC 6x40 MEA cod.956931                 | ART.501505   |
|                                                                                     | <b>0301027</b>             | UDARNO TIPLO PVC 6x60 MEA                            | ART.501507   |
|                                                                                     | <b>0301074</b>             | UDARNO TIPLO PVC 6x80 MEA                            | ART.501506   |
|                                                                                     | <b>0301028</b>             | UDARNO TIPLO PVC 8x60 MEA                            | ART.501509   |
|                                                                                     | <b>0301029</b>             | UDARNO TIPLO PVC 8x80 MEA                            | ART.501511   |
|                                                                                     | <b>0301054</b>             | UDARNO TIPLO PVC 8x100 MEA                           | ART.501513   |
|                                                                                     | <b>0301095</b>             | UDARNO TIPLO PVC 8x120 MEA                           | ART.501515   |
| <b>0301096</b>                                                                      | UDARNO TIPLO PVC 8x135 MEA | ART.501517                                           |              |
|    | <b>0301090</b>             | KUKA L OBLIK 5,6x60/22                               | ART.93251    |
|                                                                                     | <b>0301048</b>             | TIPLO ZA SIPOREX,RIGIPS,ŠUPLJU CIGLU Ø 8 MEA         | ART.(500128) |
|   | <b>0301091</b>             | KUKA L OBLIK 5,6x70/22                               | ART.93252    |
|                                                                                     | <b>0301048</b>             | TIPLO ZA SIPOREX,RIGIPS,ŠUPLJU CIGLU Ø 8 MEA         | ART.(500128) |
|  | <b>0301030</b>             | VIJCI ZA WC ŠKOLJKU, BIDE I BOJLER 8x70 PAR 2/1 MEA  | ART.(502280) |
|                                                                                     | <b>0301031</b>             | VIJCI ZA WC ŠKOLJKU, BIDE I BOJLER 10x80 PAR 2/1 MEA | ART.(502282) |
|  | <b>0301032</b>             | VIJCI ZA UMIVAONIK 10x140 PAR 2/1 MEA                | ART.95710    |
|  | <b>0301033</b>             | VIJCI ZA PISOAR 10x140 PAR 2/1 MEA BIJELO            | ART.(502284) |
|  | <b>0301034</b>             | VIJCI ZA PISOAR 10x140 PAR 2/1 MEA CROM              | ART.(502286) |
|  | <b>0301035</b>             | VIJCI ZA WC ŠKOLJKU PAR 2/1 MEA BIJELO               | ART.(502290) |
|                                                                                     | <b>0301036</b>             | VIJCI ZA WC ŠKOLJKU PAR 2/1 MEA CHROM                | ART.(502292) |





|                                                                                                                                                                         |                         |                                                        |              |
|-------------------------------------------------------------------------------------------------------------------------------------------------------------------------|-------------------------|--------------------------------------------------------|--------------|
|                                                                                        | <b>0301037</b>          | TIPLO ZA BETON Ø 4 MEA                                 | ART.(500204) |
|                                                                                                                                                                         | <b>0301038</b>          | TIPLO ZA BETON Ø 5 MEA                                 | ART.(500105) |
|                                                                                                                                                                         | <b>0301039</b>          | TIPLO ZA BETON Ø 6 MEA                                 | ART.(500106) |
|                                                                                                                                                                         | <b>0301040</b>          | TIPLO ZA BETON Ø 7 MEA                                 | ART.(500207) |
|                                                                                                                                                                         | <b>0301041</b>          | TIPLO ZA BETON Ø 8 MEA                                 | ART.(500108) |
|                                                                                                                                                                         | <b>0301042</b>          | TIPLO ZA BETON Ø 10 MEA                                | ART.(500110) |
|                                                                                                                                                                         | <b>0301043</b>          | TIPLO ZA BETON Ø 12 MEA                                | ART.(500112) |
|                                                                                                                                                                         | <b>0301044</b>          | TIPLO ZA BETON Ø 14 MEA                                | ART.(500114) |
|                                                                                                                                                                         | <b>0301045</b>          | TIPLO ZA BETON Ø 16 MEA                                | ART.(500116) |
| <b>0301046</b>                                                                                                                                                          | TIPLO ZA BETON Ø 20 MEA | ART.(500120)                                           |              |
|                                                                                        | <b>0301047</b>          | TIPLO ZA BETON, SIPOREX, RIGIPS, ŠUPLJU CIGLU Ø 6 MEA  | ART.(500126) |
|                                                                                                                                                                         | <b>0301048</b>          | TIPLO ZA BETON, SIPOREX, RIGIPS, ŠUPLJU CIGLU Ø 8 MEA  | ART.(500128) |
|                                                                                                                                                                         | <b>0301049</b>          | TIPLO ZA BETON, SIPOREX, RIGIPS, ŠUPLJU CIGLU Ø 10 MEA | ART.(500130) |
|                                                                                                                                                                         | <b>0301050</b>          | TIPLO ZA BETON, SIPOREX, RIGIPS, ŠUPLJU CIGLU Ø 12 MEA | ART.(500138) |
| <br> | <b>0301070</b>          | TIPLO FX SA VIJKOM 6x30 MEA                            | ART.96FXSZ   |
|                                                                                                                                                                         | <b>0301073</b>          | TIPLO FX SA VIJKOM 8x40 MEA                            | ART.98FXSZ   |
|                                                                                      | <b>0301072</b>          | TIPLO FL 6x60 MEA                                      | ART.500160   |
|                                                                                                                                                                         | <b>0301076</b>          | TIPLO FL 8x80 MEA                                      | ART.500161   |
|                                                                                      | <b>0301081</b>          | TIPLO UNIVERZALNO MZ 6x29 MEA                          | ART.500170   |
|                                                                                                                                                                         | <b>0301082</b>          | TIPLO UNIVERZALNO MZ 8x48 MEA                          | ART.500172   |
|                                                                                                                                                                         | <b>0301083</b>          | TIPLO UNIVERZALNO MZ 10x59 MEA                         | ART.500174   |
|                                                                                                                                                                         | <b>0301084</b>          | TIPLO UNIVERZALNO MZ 12x71 MEA                         | ART.500175   |
|                                                                                                                                                                         | <b>0301069</b>          | TIPLO UNIVERZALNO MZ 14x75 MEA                         | ART.500176   |
|                                                                                      | <b>0301063</b>          | TIPLO ZA SIPOREX GB10 MEA                              | ART.502010   |
|                                                                                                                                                                         | <b>0301067</b>          | TIPLO ZA SIPOREX GB12 MEA                              | ART.502012   |
|                                                                                                                                                                         | <b>0301097</b>          | TIPLO ZA SIPOREX GB14 MEA                              | ART.502014   |
|                                                                                      | <b>0301098</b>          | VIJAK TIPLO MFR SB 10-80 SSKS MEA                      | ART.500666   |
|                                                                                                                                                                         | <b>0301077</b>          | VIJAK TIPLO MFR SB 10-100 SSKS MEA                     | ART.500668   |
|                                                                                                                                                                         | <b>0301086</b>          | VIJAK TIPLO MFR SB 10-115 SSKS MEA                     | ART.500670   |
|                                                                                                                                                                         | <b>0301078</b>          | VIJAK TIPLO MFR SB 10-135 SSKS MEA                     | ART.500672   |
|                                                                                                                                                                         | <b>0301079</b>          | VIJAK TIPLO MFR SB 10-160 SSKS MEA                     | ART.500674   |
|                                                                                                                                                                         | <b>0301071</b>          | VIJAK TIPLO MFR SB 10-200 SSKS MEA                     | ART.500676   |
|                                                                                      | <b>0301055</b>          | TURBO VIJAK FBS 7,5-72 MEA                             | ART.505501   |
|                                                                                                                                                                         | <b>0301056</b>          | TURBO VIJAK FBS 7,5-92 MEA                             | ART.505503   |
|                                                                                                                                                                         | <b>0301057</b>          | TURBO VIJAK FBS 7,5-112 MEA                            | ART.505505   |
|                                                                                                                                                                         | <b>0301058</b>          | TURBO VIJAK FBS 7,5-132 MEA                            | ART.505507   |
|                                                                                                                                                                         | <b>0301059</b>          | TURBO VIJAK FBS 7,5-152 MEA                            | ART.505509   |
|                                                                                                                                                                         | <b>0301099</b>          | TURBO VIJAK FBS 7,5-182 MEA                            | ART.505511   |
|                                                                                                                                                                         | <b>0301100</b>          | TURBO VIJAK FBS 7,5-212 MEA                            | ART.505513   |



|                                                                                     |                               |                                            |                |
|-------------------------------------------------------------------------------------|-------------------------------|--------------------------------------------|----------------|
|    | <b>0301101</b>                | ANKER BA PLUS M8x115/50 MEA                | ART.98115 BAP  |
|                                                                                     | <b>0301118</b>                | ANKER BA PLUS M10x60/10 MEA                | ART.91060 BAP  |
|                                                                                     | <b>0301102</b>                | ANKER BA PLUS M10x85/10 MEA                | ART.91085 BAP  |
|                                                                                     | <b>0301103</b>                | ANKER BA PLUS M10x125/50 MEA               | ART.910125 BAP |
|                                                                                     | <b>0301104</b>                | ANKER BA PLUS M10x175/100 MEA              | ART.910175 BAP |
|                                                                                     | <b>0301119</b>                | ANKER BA PLUS M12x70/10 MEA                | ART.91270 BAP  |
|                                                                                     | <b>0301120</b>                | ANKER BA PLUS M12x110/10 MEA               | ART.912110 BAP |
|                                                                                     | <b>0301105</b>                | ANKER BA PLUS M12x120/20 MEA               | ART.912120 BAP |
|                                                                                     | <b>0301106</b>                | ANKER BA PLUS M12x150/50 MEA               | ART.912150 BAP |
|                                                                                     | <b>0301107</b>                | ANKER BA PLUS M12x180/80 MEA               | ART.912180 BAP |
| <b>0301108</b>                                                                      | ANKER BA PLUS M12x200/100 MEA | ART.912200 BAP                             |                |
|    | <b>0301109</b>                | METALNI ANKER SA PLUS M6                   | ART.96 SAP     |
|                                                                                     | <b>0301110</b>                | METALNI ANKER SA PLUS M8                   | ART.98 SAP     |
|                                                                                     | <b>0301111</b>                | METALNI ANKER SA PLUS M10                  | ART.910 SAP    |
|                                                                                     | <b>0301112</b>                | METALNI ANKER SA PLUS M12                  | ART.912 SAP    |
|    | <b>0301113</b>                | METALNI ANKER S PRSTENOM SA PLUS M6        | ART.96 SAPK    |
|                                                                                     | <b>0301114</b>                | METALNI ANKER S PRSTENOM SA PLUS M8        | ART.98 SAPK    |
|                                                                                     | <b>0301115</b>                | METALNI ANKER S PRSTENOM SA PLUS M10       | ART.910 SAPK   |
|                                                                                     | <b>0301116</b>                | METALNI ANKER S PRSTENOM SA PLUS M12       | ART.912 SAPK   |
|  | <b>0301075</b>                | TIPO METALNO ZA RIGIPS GKDZ 4-5 MEA        | ART.508155     |
|  | <b>0301060</b>                | TIPO ZA RIGIPS GKD 4-4,5 MEA               | ART.500890     |
|  | <b>0301062</b>                | TIPO SA VIJKOM ZA RIGIPS GKD PZ 4,5x40 MEA | ART.500892     |
|  | <b>0301065</b>                | PRSTEN SH 15-100                           | ART.507119     |
|  | <b>0301068</b>                | INJEKSIONI MORT RESIFIX PY300 SF MEA       | ART.504207     |
|  | <b>0301117</b>                | INJEKSIONI MORT RESIFIX VY 300 SF MEA      | ART.504206     |
|  | <b>0301061</b>                | PIŠTOLJ ZA INJEKSIONI MORT APP 300 MEA     | ART.504194     |



|         |                                                                                        |
|---------|----------------------------------------------------------------------------------------|
| 12032   | <b>FUGABELLA ECO SILICONE</b><br>TRANSPARENT-PROZIRNI<br>ART.03461 Pak.24 Kom x 280 ml |
| 11051   | <b>FUGABELLA ECO SILICONE</b> BIANCO-BIJELO<br>ART.03462 Pak.24 Kom x 280 ml           |
| 11282   | <b>FUGABELLA ECO SILICONE</b> BAHAMA-BEŽ<br>ART.03468 Pak.24 Kom x 280 ml              |
| 10133   | <b>FUGABELLA ECO SILICONE</b> MAGNOLIJA-ROZO<br>ART.03472 Pak.24 Kom x 280 ml          |
| 10028   | <b>FUGABELLA ECO SILICONE</b> GRIGIO-SIVO<br>ART.03465 Pak.24 Kom x 280 ml             |
| 0303012 | <b>FUGABELLA ECO SILICONE</b> FERRO-TAMNO SIVI<br>ART.10840 Pak.24 Kom x 280 ml        |
| 0303013 | <b>FUGABELLA ECO SILICONE</b> MARRONE<br>ART.03463 Pak.24 Kom x 280 ml                 |
| 0303010 | <b>FUGABELLA ECO SILICONE</b> CAMEL<br>ART.03473 Pak.24 Kom x 280 ml                   |
| 0303011 | <b>FUGABELLA ECO SILICONE</b> JASMIN<br>ART.03563 (03469) 310 ml                       |
| 0303017 | <b>FUGABELLA ECO SILICONE</b> GRIGIO LUCE<br>ART.03573 310 ml                          |
| 0303018 | <b>FUGABELLA ECO SILICONE</b> TERRACOTA<br>ART.03569 310 ml                            |
| 0303019 | <b>FUGABELLA ECO SILICONE</b> NOCE<br>ART.03185 310 ml                                 |
| 0303020 | <b>FUGABELLA ECO SILICONE</b> CEMENTO<br>ART.03178 310 ml                              |
| 0303021 | <b>FUGABELLA ECO SILICONE</b> ROSSO<br>ART.03585 310 ml                                |
| 0303022 | <b>FUGABELLA ECO SILICONE</b> ANTRACITE<br>ART.03177 310 ml                            |
| 0303023 | <b>FUGABELLA ECO SILICONE</b> LIMESTONE<br>ART.03906 310 ml                            |
| 0303024 | <b>FUGABELLA ECO SILICONE</b> SILVER<br>ART.03595 310 ml                               |
| 0303025 | <b>FUGABELLA ECO SILICONE</b> PERGAMON<br>ART.03603 310 ml                             |
| 0303026 | <b>FUGABELLA ECO SILICONE</b> EUCALIPTO<br>ART.03589 310 ml                            |
| 10135   | <b>FUGABELLA ECO SILICONE PU</b> BIANCO - BIJELO<br>ART.03553 Pak.12 Kom x 310 ml      |
| 10147   | <b>FUGABELLA ECO SILICONE PU</b><br>GRIGIO PERLA-SIVO<br>ART.03552 Pak.12 Kom x 310 ml |
| 0303016 | <b>FUGABELLA ECO SILICONE PU</b> BEIGE<br>ART.03551 310 ml                             |
| 0303014 | <b>FUGABELLA ECO SILICONE PU40</b> GRIGIO PERLA<br>ART.10810 310 ml                    |



|                                                                                                                                                                                                                                                                                                                                                                                                                                                                                                                                                                                                                                                                                                                                                                                                                                                                                                                                    |                                                                                                                                                       |                                                                                                                                                                                                                                                                                                                                                                                                                                                                                                                                    |
|------------------------------------------------------------------------------------------------------------------------------------------------------------------------------------------------------------------------------------------------------------------------------------------------------------------------------------------------------------------------------------------------------------------------------------------------------------------------------------------------------------------------------------------------------------------------------------------------------------------------------------------------------------------------------------------------------------------------------------------------------------------------------------------------------------------------------------------------------------------------------------------------------------------------------------|-------------------------------------------------------------------------------------------------------------------------------------------------------|------------------------------------------------------------------------------------------------------------------------------------------------------------------------------------------------------------------------------------------------------------------------------------------------------------------------------------------------------------------------------------------------------------------------------------------------------------------------------------------------------------------------------------|
| <p><b>CS 25</b></p> <p>Za brtvljenje spojnica zidnih i podnih površina, spojnica u kupaonici, kuhinji i WC-u i drugim prostorijama s povećanom vlažnošću. Veliki izbor boja prema bojama pločica, fug masa i sanitarija.</p> <p><b>KARAKTERISTIKE</b></p> <ul style="list-style-type: none"> <li>• antifungicidan</li> <li>• elastičan</li> <li>• otporan na pucanje i skupljanje</li> <li>• otporan na kemikalije, stvaranje plijesni, starenje, promjenu boje i visoke temperature</li> <li>• za unutarnju i vanjsku uporabu</li> <li>• otporan na UV zračenje</li> </ul>                                                                                                                                                                                      | <p>1381015</p> <p>1381016</p> <p>1381017</p> <p>1381018</p> <p>1381019</p> <p>1381020</p> <p>1381021</p> <p>1381033</p> <p>1381034</p> <p>1381035</p> | <p><b>CS25</b> SANITARNI SILIKON TRANSPARENT 280 ml</p> <p><b>CS25</b> SANITARNI SILIKON BIJELO 280ml</p> <p><b>CS25</b> SANITARNI SILIKON MANHATTAN 280 ml</p> <p><b>CS25</b> SANITARNI SILIKON SIVO 280 ml</p> <p><b>CS25</b> SANITARNI SILIKON BAHAMA 280 ml</p> <p><b>CS25</b> SANITARNI SILIKON JASMIN 280 ml</p> <p><b>CS25</b> SANITARNI SILIKON SILVER 280 ml</p> <p><b>CS25</b> SANITARNI SILIKON ANTRACIT 280 ml</p> <p><b>CS25</b> SANITARNI SILIKON TERRA 280 ml</p> <p><b>CS25</b> SANITARNI SILIKON CAMEL 280 ml</p> |
| <p><b>CS 24</b></p> <p>Za brtvljenje spojeva na prozorima, vratima, kao i za brtvljenje dilatacijskih spojeva. Za glaziranje. Za brtvljenje prozora i vrata. Za brtvljenje dilatacijskih spojeva.</p> <p><b>KARAKTERISTIKE</b></p> <ul style="list-style-type: none"> <li>• Izvršna adhezija na mnoge ne porozne površine, kao što su staklo, glazirane keramičke pločice i aluminij</li> <li>• Otporan na vlagu</li> <li>• Otporan na plijesan</li> <li>• Otporan na UV zračenje i temperaturne razlike</li> </ul>                                                                                                                                                                                                                                             | <p>1381022</p> <p>1381023</p>                                                                                                                         | <p><b>CS24</b> UNIVERZALNI SILIKON TRANSPARENT 280 ml</p> <p><b>CS24</b> UNIVERZALNI SILIKON BIJELO 280 ml</p>                                                                                                                                                                                                                                                                                                                                                                                                                     |
| <p><b>CS 11</b></p> <p>Za brtvljenje unutarnjih i vanjskih spojnica kod kojih ne dolazi do velikih opterećenja, npr. na unutarnjim vratima, prozorskim okvirima, kutijama za rolete i sl. Prikladan za primjenu na zidu, betonu, drvetu, cigli, eloksiranom aluminiju. Za unutarnju i vanjsku uporabu. Za brtvljenje pukotina.</p> <p><b>KARAKTERISTIKE</b></p> <ul style="list-style-type: none"> <li>• Plasto - elastična masa</li> <li>• Prianja i na upijajuće površine</li> <li>• Pogodan za bojenje</li> <li>• Bez mirisa</li> </ul>                                                                                                                                                                                                                   | <p>1381024</p>                                                                                                                                        | <p><b>CS11</b> AKRILNI SEALANT BIJELO 280 ml</p>                                                                                                                                                                                                                                                                                                                                                                                                                                                                                   |
| <p><b>POTROŠNJA: 300 g/m<sup>2</sup></b></p> <p><b>Express Fix</b></p> <p>Aplikacije:</p> <ul style="list-style-type: none"> <li>• opeka</li> <li>• keramika</li> <li>• beton</li> <li>• lesanit i gipsna ploča</li> <li>• ljepenka</li> <li>• kamen</li> <li>• MDF ploča</li> <li>• UPVC</li> </ul> <p><b>KARAKTERISTIKE</b></p> <ul style="list-style-type: none"> <li>• koristi se za upijajuće i neupijajuće površine</li> <li>• otporan na vodu i loše klimatske uvjete</li> <li>• jednostavna primjena na niskim temperaturama (-10 °C)</li> <li>• nema potrebe za osiguravanjem spojeva sredstvima za mehaničko fiksiranje</li> <li>• za vanjsku i unutarnju uporabu</li> <li>• mogućnost bojenja kada se osuši</li> <li>• slabog mirisa</li> </ul>   | <p>1381029</p>                                                                                                                                        | <p><b>EXPRESS FIX</b> MONTAŽNO LJEPILO PAK. 375 g</p>                                                                                                                                                                                                                                                                                                                                                                                                                                                                              |
| <p><b>POTROŠNJA: 300 g/m<sup>2</sup></b></p> <p><b>FT 101</b></p> <p>Aplikacije:</p> <ul style="list-style-type: none"> <li>- Učvršćivanje okvira prozora i vrata</li> <li>- Popunjavanje šupljina</li> <li>- Zaprtivanje otvora u krovnim konstrukcijama i izolacionim materijalima</li> <li>- Zvučna izolacija</li> <li>- Popunjavanje šupljina oko cijevi</li> <li>- Učvršćivanje i postavljanje zidnih ploča i crijeva</li> </ul> <p><b>KARAKTERISTIKE</b></p> <ul style="list-style-type: none"> <li>• Odlična adhezija na većinu materijala</li> <li>• Visoka toplotna i akustična izolacija</li> <li>• Otpornost na vlagu</li> <li>• Dugotrajnost</li> <li>• Ekonomičnost – precizno doziranje</li> <li>• Bijele, sive i braon boje</li> </ul>                                                                                           | <p>1381030</p> <p>1381056</p> <p>1381057</p>                                                                                                          | <p><b>FT 101</b> MULTIFUNKCIONALNO LJEPILO BIJELO 280 ml</p> <p><b>FT 101</b> MULTIFUNKCIONALNO LJEPILO TRANSPARENT 280 ml</p> <p><b>FT 101</b> MULTIFUNKCIONALNO LJEPILO SIVO 280 ml</p>                                                                                                                                                                                                                                                                                                                                          |

|                                                                                     |                                                                   |                                                                                                                                                                                                |
|-------------------------------------------------------------------------------------|-------------------------------------------------------------------|------------------------------------------------------------------------------------------------------------------------------------------------------------------------------------------------|
|    | <p><b>1142001</b></p> <p><b>1142002</b></p> <p><b>1142003</b></p> | <p>SILIKON OLIVÉ SANITARY 300 ml,BOJA TRANSPARENT (CLEAR)</p> <p>SILIKON OLIVÉ SANITARY 300 ml,BOJA BIJELA (WHITE) RAL 9016</p> <p>SILIKON OLIVÉ SANITARY 300 ml,BOJA SIVA (GREY) RAL 7035</p> |
|    | <p><b>1142004</b></p>                                             | <p>SILIKON OLISEAL CONSTRUCCION 290 ml,BOJA BIJELA (WHITE) RAL 9016</p>                                                                                                                        |
|  | <p><b>1142005</b></p>                                             | <p>SILIKON OLISEAL CRYSTAL 290 ml,BOJA TRANSPARENT (CLEAR)</p>                                                                                                                                 |
|  | <p><b>1142006</b></p>                                             | <p>AKRILNI SILIKON OLIVÉ CAULKING 280 ml,BOJA BIJELA (WHITE) RAL 9010</p>                                                                                                                      |
|  | <p><b>1142007</b></p>                                             | <p>SILIKON OLIVÉ JUNITAS MOTOR 300 ml,BOJA SIVA (GREY) RAL 7047 TEMPERATURA -40°C DO +280°C</p>                                                                                                |

|                                                                                     |                       |                                                                   |
|-------------------------------------------------------------------------------------|-----------------------|-------------------------------------------------------------------|
|    | <p><b>1142008</b></p> | <p>SILIKON OLIVÉ 1200°C 300 ml,BOJA CRNA (BLACK) RAL 9011</p>     |
|    | <p><b>1142009</b></p> | <p>SILIKON OLIVÉ C-22 300 ml,BOJA TRANSPARENT (CLEAR)</p>         |
|  | <p><b>1142011</b></p> | <p>SILIKON OLIVÉ MULTIUSO 280 ml,BOJA TRANSPARENT (CLEAR)</p>     |
|  | <p><b>1142012</b></p> | <p>SILIKON OLIVÉ MULTIUSO 280 ml,BOJA BIJELA (WHITE) RAL 9016</p> |
|  | <p><b>1142018</b></p> | <p>PUR PJENA OLIVÉ PU 476 PIŠTOLJSKA VATROOTPORNNA 750 ml</p>     |







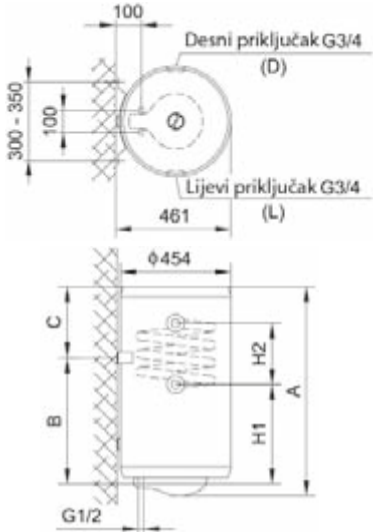

|                                                                                     |                |                                                                |
|-------------------------------------------------------------------------------------|----------------|----------------------------------------------------------------|
|    | <p>1142014</p> | <p>PUR PJENA OLIVÉ PU 460 750 ml</p>                           |
|    | <p>1142020</p> | <p>PUR PJENA OLIVÉ PU 470 PIŠTOLJSKA 750 ml</p>                |
|  | <p>1142015</p> | <p>SPREJ ZA ČIŠČENJE PUR PJENE OLIVÉ LIMPIADOR R-47 500 ml</p> |
|  | <p>1142016</p> | <p>PIŠTOLJ ZA SILIKON OLIVÉ PISTOLA S2</p>                     |
|  | <p>1142017</p> | <p>PIŠTOLJ ZA PUR PJENU OLIVÉ PU PRACTICA</p>                  |

|                                                                                     |               |                                                                            |                           |
|-------------------------------------------------------------------------------------|---------------|----------------------------------------------------------------------------|---------------------------|
|   | 0209018       | BOJLER KONČAR 30 L                                                         | <b>EGV-30.2 RI</b> BIJELO |
|                                                                                     | 01199         | BOJLER KONČAR 50 L                                                         | <b>EGV-50.2 TI</b> BIJELO |
|                                                                                     | 01201         | BOJLER KONČAR 50 L                                                         | <b>EGV-50.2 TI</b> BEŽ    |
|                                                                                     | 01200         | BOJLER KONČAR 50 L                                                         | <b>EGV-50.2 TI</b> PLAVO  |
|                                                                                     | 01202         | BOJLER KONČAR 50 L                                                         | <b>EGV-50.2 TI</b> ZELENO |
|                                                                                     | 01243         | BOJLER KONČAR 50 L<br>VANJSKA REGULACIJA                                   | <b>EGV-50.2 RI</b> BIJELO |
|                                                                                     | 0209021       | BOJLER KONČAR 80 L<br>VANJSKA REGULACIJA                                   | <b>EGV-80.2 RI</b> BIJELO |
|                                                                                     | 01205         | BOJLER KONČAR 80 L                                                         | <b>EGV-80.2 TI</b> BEŽ    |
|                                                                                     | 01204         | BOJLER KONČAR 80 L                                                         | <b>EGV-80.2 TI</b> PLAVO  |
|                                                                                     | 01206         | BOJLER KONČAR 80 L                                                         | <b>EGV-80.2 TI</b> ZELENO |
|                                                                                     | 01203         | BOJLER KONČAR 80 L                                                         | <b>EGV-80.2 TI</b> BIJELO |
|                                                                                     | 01251         | BOJLER KONČAR 80 L<br>UNUTARNJA REGULACIJA                                 | <b>EGV-81.2 TI</b> BIJELO |
|                                                                                     | 0209022       | BOJLER KONČAR                                                              | <b>EGV-51.1 TI</b>        |
|                                                                                     | 0209023       | BOJLER KONČAR                                                              | <b>EGV-101.2 RI</b>       |
| 0209024                                                                             | BOJLER KONČAR | <b>EGV-121.2 RI</b>                                                        |                           |
|  | 0209030       | BOJLER KOMBINIRANI KONČAR 50 L<br><b>EGVK-50 L RLI</b> LIJEVI SX BIJELO    |                           |
|                                                                                     | 0209031       | BOJLER KOMBINIRANI KONČAR 50 L<br><b>EGVK-50 L RDI</b> DESNI DX BIJELO     |                           |
|                                                                                     | 0209019       | BOJLER KOMBINIRANI KONČAR 80 L<br><b>EGVK-81.21 RLI</b> LIJEVI SX BIJELO   |                           |
|                                                                                     | 0209020       | BOJLER KOMBINIRANI KONČAR 80 L<br><b>EGVK-81.21 RDI</b> DESNI DX BIJELO    |                           |
|                                                                                     | 0209025       | BOJLER KOMBINIRANI KONČAR 100 L<br><b>EGVK-101.23 RLI</b> LIJEVI SX BIJELO |                           |
|                                                                                     | 0209026       | BOJLER KOMBINIRANI KONČAR 100 L<br><b>EGVK-101.23 RDI</b> DESNI DX BIJELO  |                           |
|                                                                                     | 0209027       | BOJLER KOMBINIRANI KONČAR 120 L<br><b>EGVK-121.23 RLI</b> LIJEVI SX BIJELO |                           |
|                                                                                     | 0209028       | BOJLER KOMBINIRANI KONČAR 120 L<br><b>EGVK-121.23 RDI</b> DESNI DX BIJELO  |                           |

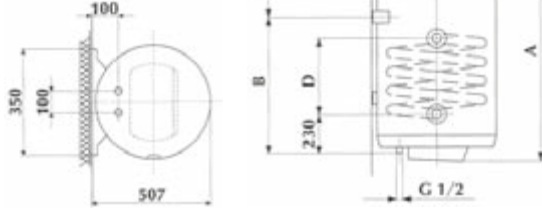
|                                                                                    |                                                                                 |                                                                                                                           |                                                                                                     |
|------------------------------------------------------------------------------------|---------------------------------------------------------------------------------|---------------------------------------------------------------------------------------------------------------------------|-----------------------------------------------------------------------------------------------------|
|   | <p><b>01110</b></p> <p><b>01111</b></p> <p><b>01057</b></p> <p><b>01058</b></p> | <p>BOJLER KONČAR 5 L N.P.</p> <p>BOJLER KONČAR 5 L P.P.</p> <p>BOJLER KONČAR 10 L N.P.</p> <p>BOJLER KONČAR 10 L P.P.</p> | <p><b>EGV-5-2R</b></p> <p><b>EGV-5 P-2RP</b></p> <p><b>EGV-10-2R</b></p> <p><b>EGV-10 P-2RP</b></p> |
|  | <p><b>01259</b></p> <p><b>01258</b></p>                                         | <p>BOJLER PROTOČNI N/P 3,5 kW</p> <p>BOJLER PROTOČNI N/P 5 kW</p>                                                         | <p><b>ETA-0733</b></p> <p><b>ETA-1733</b></p>                                                       |

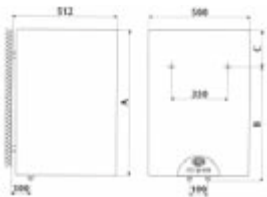
| <p>70, 100, 138, 140, 140, 390, 264, 5 litara, 213, 256</p>                                                                                                                                                                                                                                                                                                                                                                                                                                                                                                                                                                                                                                                                                                                                                                                                                          | <p><b>01020</b></p> <p><b>01006</b></p>                                                                                         | <p>BOJLER 5 L NISKOTLAČNI ZA MJEŠALICU, PVC KAZAN NADPULTNI ART. <b>TEG 5 O 307504</b></p> <p>BOJLER 5 L NISKOTLAČNI ZA MJEŠALICU, PVC KAZAN PODPULTNI ART. <b>TEG 5 U 307505</b></p>                                                                                                                                                                                                                                             |           |           |           |           |                  |     |     |        |     |     |                              |       |       |                                         |                                                                                                                                                                                                    |      |        |     |     |     |     |     |        |     |     |     |     |     |                              |       |       |       |       |       |                                        |                |          |           |           |           |                                                                                                                                                                       |                                                                                                                                                                                                                                                                                                                                                                                                                                                                                                                                                                                                                                                                                          |
|--------------------------------------------------------------------------------------------------------------------------------------------------------------------------------------------------------------------------------------------------------------------------------------------------------------------------------------------------------------------------------------------------------------------------------------------------------------------------------------------------------------------------------------------------------------------------------------------------------------------------------------------------------------------------------------------------------------------------------------------------------------------------------------------------------------------------------------------------------------------------------------|---------------------------------------------------------------------------------------------------------------------------------|-----------------------------------------------------------------------------------------------------------------------------------------------------------------------------------------------------------------------------------------------------------------------------------------------------------------------------------------------------------------------------------------------------------------------------------|-----------|-----------|-----------|-----------|------------------|-----|-----|--------|-----|-----|------------------------------|-------|-------|-----------------------------------------|----------------------------------------------------------------------------------------------------------------------------------------------------------------------------------------------------|------|--------|-----|-----|-----|-----|-----|--------|-----|-----|-----|-----|-----|------------------------------|-------|-------|-------|-------|-------|----------------------------------------|----------------|----------|-----------|-----------|-----------|-----------------------------------------------------------------------------------------------------------------------------------------------------------------------|------------------------------------------------------------------------------------------------------------------------------------------------------------------------------------------------------------------------------------------------------------------------------------------------------------------------------------------------------------------------------------------------------------------------------------------------------------------------------------------------------------------------------------------------------------------------------------------------------------------------------------------------------------------------------------------|
| <p>265, 350, 140, 500, 398, 10 litara, 70, 100</p>                                                                                                                                                                                                                                                                                                                                                                                                                                                                                                                                                                                                                                                                                                                                                                                                                                   | <p><b>01018</b></p> <p><b>01019</b></p> <p><b>0207052</b></p> <p><b>0207057</b></p> <p><b>0207050</b></p> <p><b>0207051</b></p> | <p>BOJLER 10 L NISKOTLAČNI ZA MJEŠALICU, PVC KAZAN NADPULTNI ART. <b>TEG 010 ON 304038</b></p> <p>BOJLER 10 L NISKOTLAČNI ZA MJEŠALICU, PVC KAZAN PODPULTNI ART. <b>TEG 010 UN 304041</b></p> <p>BOJLER 5 L TLAČNI ART. <b>GT 5 U 297406</b></p> <p>BOJLER 5 L TLAČNI ART. <b>GT 5 O 580189</b></p> <p>BOJLER 10 L TLAČNI PODPULTNI ART. <b>GT 10/U 297415</b></p> <p>BOJLER 10 L TLAČNI NADPULTNI ART. <b>GT 10/O 297414</b></p> |           |           |           |           |                  |     |     |        |     |     |                              |       |       |                                         |                                                                                                                                                                                                    |      |        |     |     |     |     |     |        |     |     |     |     |     |                              |       |       |       |       |       |                                        |                |          |           |           |           |                                                                                                                                                                       |                                                                                                                                                                                                                                                                                                                                                                                                                                                                                                                                                                                                                                                                                          |
| <p>2454, 358, 100, 461</p> <table border="1"> <thead> <tr> <th>Model</th> <th>TGR 30 N</th> <th>TGR 50 N</th> <th>TGR 80 N</th> <th>TGR 100 N</th> <th>TGR 120 N</th> </tr> </thead> <tbody> <tr> <td>Priključne mjere</td> <td></td> <td></td> <td></td> <td></td> <td></td> </tr> <tr> <td>A (mm)</td> <td>468</td> <td>570</td> <td>775</td> <td>935</td> <td>1090</td> </tr> <tr> <td>B (mm)</td> <td>275</td> <td>355</td> <td>505</td> <td>715</td> <td>805</td> </tr> <tr> <td>C (mm)</td> <td>172</td> <td>185</td> <td>190</td> <td>200</td> <td>205</td> </tr> <tr> <td>Priključi na vodovodnu mrežu</td> <td>G 1/2</td> <td>G 1/2</td> <td>G 1/2</td> <td>G 1/2</td> <td>G 1/2</td> </tr> <tr> <td>Težina prazna/s ambalažom/s vodom (kg)</td> <td>18,5/17,5/15,5</td> <td>21/23/21</td> <td>27/29/107</td> <td>31/32/121</td> <td>35/38/155</td> </tr> </tbody> </table> | Model                                                                                                                           | TGR 30 N                                                                                                                                                                                                                                                                                                                                                                                                                          | TGR 50 N  | TGR 80 N  | TGR 100 N | TGR 120 N | Priključne mjere |     |     |        |     |     | A (mm)                       | 468   | 570   | 775                                     | 935                                                                                                                                                                                                | 1090 | B (mm) | 275 | 355 | 505 | 715 | 805 | C (mm) | 172 | 185 | 190 | 200 | 205 | Priključi na vodovodnu mrežu | G 1/2 | G 1/2 | G 1/2 | G 1/2 | G 1/2 | Težina prazna/s ambalažom/s vodom (kg) | 18,5/17,5/15,5 | 21/23/21 | 27/29/107 | 31/32/121 | 35/38/155 | <p><b>01255</b></p> <p><b>01001</b></p> <p><b>01002</b></p> <p><b>01005</b></p> <p><b>01252</b></p> <p><b>0207045</b></p> <p><b>0207044</b></p> <p><b>0207046</b></p> | <p>BOJLER 30 L EMAJLIRANI KAZAN, VANJSKA REGULACIJA ART. <b>TGR 30 580132</b></p> <p>BOJLER 50 L EMAJLIRANI KAZAN, VANJSKA REGULACIJA ART. <b>TGR 50 762240</b></p> <p>BOJLER 80 L EMAJLIRANI KAZAN, VANJSKA REGULACIJA ART. <b>TGR 80 762241</b></p> <p>BOJLER 100 L EMAJLIRANI KAZAN, VANJSKA REGULACIJA ART. <b>TGR 100 762242</b></p> <p>BOJLER 120 L EMAJLIRANI KAZAN, VANJSKA REGULACIJA ART. <b>TGR 120 580136</b></p> <p>BOJLER 50 L EMAJLIRANI KAZAN, UNUTARNJA REGULACIJA ART. <b>TG 50 762237</b></p> <p>BOJLER 80 L EMAJLIRANI KAZAN, UNUTARNJA REGULACIJA ART. <b>TG 80 762238</b></p> <p>BOJLER 100 L EMAJLIRANI KAZAN, UNUTARNJA REGULACIJA ART. <b>TG 100 762239</b></p> |
| Model                                                                                                                                                                                                                                                                                                                                                                                                                                                                                                                                                                                                                                                                                                                                                                                                                                                                                | TGR 30 N                                                                                                                        | TGR 50 N                                                                                                                                                                                                                                                                                                                                                                                                                          | TGR 80 N  | TGR 100 N | TGR 120 N |           |                  |     |     |        |     |     |                              |       |       |                                         |                                                                                                                                                                                                    |      |        |     |     |     |     |     |        |     |     |     |     |     |                              |       |       |       |       |       |                                        |                |          |           |           |           |                                                                                                                                                                       |                                                                                                                                                                                                                                                                                                                                                                                                                                                                                                                                                                                                                                                                                          |
| Priključne mjere                                                                                                                                                                                                                                                                                                                                                                                                                                                                                                                                                                                                                                                                                                                                                                                                                                                                     |                                                                                                                                 |                                                                                                                                                                                                                                                                                                                                                                                                                                   |           |           |           |           |                  |     |     |        |     |     |                              |       |       |                                         |                                                                                                                                                                                                    |      |        |     |     |     |     |     |        |     |     |     |     |     |                              |       |       |       |       |       |                                        |                |          |           |           |           |                                                                                                                                                                       |                                                                                                                                                                                                                                                                                                                                                                                                                                                                                                                                                                                                                                                                                          |
| A (mm)                                                                                                                                                                                                                                                                                                                                                                                                                                                                                                                                                                                                                                                                                                                                                                                                                                                                               | 468                                                                                                                             | 570                                                                                                                                                                                                                                                                                                                                                                                                                               | 775       | 935       | 1090      |           |                  |     |     |        |     |     |                              |       |       |                                         |                                                                                                                                                                                                    |      |        |     |     |     |     |     |        |     |     |     |     |     |                              |       |       |       |       |       |                                        |                |          |           |           |           |                                                                                                                                                                       |                                                                                                                                                                                                                                                                                                                                                                                                                                                                                                                                                                                                                                                                                          |
| B (mm)                                                                                                                                                                                                                                                                                                                                                                                                                                                                                                                                                                                                                                                                                                                                                                                                                                                                               | 275                                                                                                                             | 355                                                                                                                                                                                                                                                                                                                                                                                                                               | 505       | 715       | 805       |           |                  |     |     |        |     |     |                              |       |       |                                         |                                                                                                                                                                                                    |      |        |     |     |     |     |     |        |     |     |     |     |     |                              |       |       |       |       |       |                                        |                |          |           |           |           |                                                                                                                                                                       |                                                                                                                                                                                                                                                                                                                                                                                                                                                                                                                                                                                                                                                                                          |
| C (mm)                                                                                                                                                                                                                                                                                                                                                                                                                                                                                                                                                                                                                                                                                                                                                                                                                                                                               | 172                                                                                                                             | 185                                                                                                                                                                                                                                                                                                                                                                                                                               | 190       | 200       | 205       |           |                  |     |     |        |     |     |                              |       |       |                                         |                                                                                                                                                                                                    |      |        |     |     |     |     |     |        |     |     |     |     |     |                              |       |       |       |       |       |                                        |                |          |           |           |           |                                                                                                                                                                       |                                                                                                                                                                                                                                                                                                                                                                                                                                                                                                                                                                                                                                                                                          |
| Priključi na vodovodnu mrežu                                                                                                                                                                                                                                                                                                                                                                                                                                                                                                                                                                                                                                                                                                                                                                                                                                                         | G 1/2                                                                                                                           | G 1/2                                                                                                                                                                                                                                                                                                                                                                                                                             | G 1/2     | G 1/2     | G 1/2     |           |                  |     |     |        |     |     |                              |       |       |                                         |                                                                                                                                                                                                    |      |        |     |     |     |     |     |        |     |     |     |     |     |                              |       |       |       |       |       |                                        |                |          |           |           |           |                                                                                                                                                                       |                                                                                                                                                                                                                                                                                                                                                                                                                                                                                                                                                                                                                                                                                          |
| Težina prazna/s ambalažom/s vodom (kg)                                                                                                                                                                                                                                                                                                                                                                                                                                                                                                                                                                                                                                                                                                                                                                                                                                               | 18,5/17,5/15,5                                                                                                                  | 21/23/21                                                                                                                                                                                                                                                                                                                                                                                                                          | 27/29/107 | 31/32/121 | 35/38/155 |           |                  |     |     |        |     |     |                              |       |       |                                         |                                                                                                                                                                                                    |      |        |     |     |     |     |     |        |     |     |     |     |     |                              |       |       |       |       |       |                                        |                |          |           |           |           |                                                                                                                                                                       |                                                                                                                                                                                                                                                                                                                                                                                                                                                                                                                                                                                                                                                                                          |
| <p>200, B, C, 2500, A, 350, 100, 100, 507</p> <table border="1"> <thead> <tr> <th>Model</th> <th>GBL 50 N</th> <th>GBL 80 N</th> </tr> </thead> <tbody> <tr> <td>A (mm)</td> <td>583</td> <td>803</td> </tr> <tr> <td>B (mm)</td> <td>145</td> <td>345</td> </tr> <tr> <td>C (mm)</td> <td>185</td> <td>205</td> </tr> <tr> <td>Priključi na vodovodnu mrežu</td> <td>G 1/2</td> <td>G 1/2</td> </tr> </tbody> </table>                                                                                                                                                                                                                                                                                                                                                                                                                                                              | Model                                                                                                                           | GBL 50 N                                                                                                                                                                                                                                                                                                                                                                                                                          | GBL 80 N  | A (mm)    | 583       | 803       | B (mm)           | 145 | 345 | C (mm) | 185 | 205 | Priključi na vodovodnu mrežu | G 1/2 | G 1/2 | <p><b>01235</b></p> <p><b>01242</b></p> | <p>BOJLER 50 L MONTAŽA NA STROP, EMAJL. KAZAN, VANJSKA REGULACIJA ART. <b>GBL 50 N 58150</b></p> <p>BOJLER 80 L MONTAŽA NA STROP, EMAJL. KAZAN, VANJSKA REGULACIJA ART. <b>GBL 80 N 580151</b></p> |      |        |     |     |     |     |     |        |     |     |     |     |     |                              |       |       |       |       |       |                                        |                |          |           |           |           |                                                                                                                                                                       |                                                                                                                                                                                                                                                                                                                                                                                                                                                                                                                                                                                                                                                                                          |
| Model                                                                                                                                                                                                                                                                                                                                                                                                                                                                                                                                                                                                                                                                                                                                                                                                                                                                                | GBL 50 N                                                                                                                        | GBL 80 N                                                                                                                                                                                                                                                                                                                                                                                                                          |           |           |           |           |                  |     |     |        |     |     |                              |       |       |                                         |                                                                                                                                                                                                    |      |        |     |     |     |     |     |        |     |     |     |     |     |                              |       |       |       |       |       |                                        |                |          |           |           |           |                                                                                                                                                                       |                                                                                                                                                                                                                                                                                                                                                                                                                                                                                                                                                                                                                                                                                          |
| A (mm)                                                                                                                                                                                                                                                                                                                                                                                                                                                                                                                                                                                                                                                                                                                                                                                                                                                                               | 583                                                                                                                             | 803                                                                                                                                                                                                                                                                                                                                                                                                                               |           |           |           |           |                  |     |     |        |     |     |                              |       |       |                                         |                                                                                                                                                                                                    |      |        |     |     |     |     |     |        |     |     |     |     |     |                              |       |       |       |       |       |                                        |                |          |           |           |           |                                                                                                                                                                       |                                                                                                                                                                                                                                                                                                                                                                                                                                                                                                                                                                                                                                                                                          |
| B (mm)                                                                                                                                                                                                                                                                                                                                                                                                                                                                                                                                                                                                                                                                                                                                                                                                                                                                               | 145                                                                                                                             | 345                                                                                                                                                                                                                                                                                                                                                                                                                               |           |           |           |           |                  |     |     |        |     |     |                              |       |       |                                         |                                                                                                                                                                                                    |      |        |     |     |     |     |     |        |     |     |     |     |     |                              |       |       |       |       |       |                                        |                |          |           |           |           |                                                                                                                                                                       |                                                                                                                                                                                                                                                                                                                                                                                                                                                                                                                                                                                                                                                                                          |
| C (mm)                                                                                                                                                                                                                                                                                                                                                                                                                                                                                                                                                                                                                                                                                                                                                                                                                                                                               | 185                                                                                                                             | 205                                                                                                                                                                                                                                                                                                                                                                                                                               |           |           |           |           |                  |     |     |        |     |     |                              |       |       |                                         |                                                                                                                                                                                                    |      |        |     |     |     |     |     |        |     |     |     |     |     |                              |       |       |       |       |       |                                        |                |          |           |           |           |                                                                                                                                                                       |                                                                                                                                                                                                                                                                                                                                                                                                                                                                                                                                                                                                                                                                                          |
| Priključi na vodovodnu mrežu                                                                                                                                                                                                                                                                                                                                                                                                                                                                                                                                                                                                                                                                                                                                                                                                                                                         | G 1/2                                                                                                                           | G 1/2                                                                                                                                                                                                                                                                                                                                                                                                                             |           |           |           |           |                  |     |     |        |     |     |                              |       |       |                                         |                                                                                                                                                                                                    |      |        |     |     |     |     |     |        |     |     |     |     |     |                              |       |       |       |       |       |                                        |                |          |           |           |           |                                                                                                                                                                       |                                                                                                                                                                                                                                                                                                                                                                                                                                                                                                                                                                                                                                                                                          |

|  <table border="1" data-bbox="459 241 812 303"> <tr> <td></td> <td>A</td> <td>B</td> <td>C</td> <td>H1</td> <td>H2</td> </tr> <tr> <td>TGRK 80 D/L</td> <td>775</td> <td>565</td> <td>190</td> <td>355</td> <td>200</td> </tr> </table>  <p>Desni priključak G3/4 (D)<br/>Lijevi priključak G3/4 (L)<br/>G1/2</p>                                                                                                                                                                                                                                                                                                                                                                                                                           |              | A             | B             | C             | H1           | H2           | TGRK 80 D/L | 775  | 565    | 190 | 355 | 200  |        | <p>BOJLER 80 L<br/>UNIVERZALNI</p> <p>ART. <b>TGRK 80 L 419799</b></p> |     |     |        |     |        |     |                              |       |       |       |                                                                               |                                                                                                                                                                                                                                                                                                                                                                                                                                                                                                                                                                                |       |       |       |       |                               |                                                                                                                                                                                                     |
|---------------------------------------------------------------------------------------------------------------------------------------------------------------------------------------------------------------------------------------------------------------------------------------------------------------------------------------------------------------------------------------------------------------------------------------------------------------------------------------------------------------------------------------------------------------------------------------------------------------------------------------------------------------------------------------------------------------------------------------------------------------------------------------------------------------------------------------------------------------------------------------------------------------|--------------|---------------|---------------|---------------|--------------|--------------|-------------|------|--------|-----|-----|------|--------|------------------------------------------------------------------------|-----|-----|--------|-----|--------|-----|------------------------------|-------|-------|-------|-------------------------------------------------------------------------------|--------------------------------------------------------------------------------------------------------------------------------------------------------------------------------------------------------------------------------------------------------------------------------------------------------------------------------------------------------------------------------------------------------------------------------------------------------------------------------------------------------------------------------------------------------------------------------|-------|-------|-------|-------|-------------------------------|-----------------------------------------------------------------------------------------------------------------------------------------------------------------------------------------------------|
|                                                                                                                                                                                                                                                                                                                                                                                                                                                                                                                                                                                                                                                                                                                                                                                                                                                                                                               | A            | B             | C             | H1            | H2           |              |             |      |        |     |     |      |        |                                                                        |     |     |        |     |        |     |                              |       |       |       |                                                                               |                                                                                                                                                                                                                                                                                                                                                                                                                                                                                                                                                                                |       |       |       |       |                               |                                                                                                                                                                                                     |
| TGRK 80 D/L                                                                                                                                                                                                                                                                                                                                                                                                                                                                                                                                                                                                                                                                                                                                                                                                                                                                                                   | 775          | 565           | 190           | 355           | 200          |              |             |      |        |     |     |      |        |                                                                        |     |     |        |     |        |     |                              |       |       |       |                                                                               |                                                                                                                                                                                                                                                                                                                                                                                                                                                                                                                                                                                |       |       |       |       |                               |                                                                                                                                                                                                     |
|   <table border="1" data-bbox="156 1354 809 1492"> <thead> <tr> <th>Model</th> <th>GBK 80 RN/LN</th> <th>GBK 100 RN/LN</th> <th>GBK 120 RN/LN</th> </tr> </thead> <tbody> <tr> <td>A (mm)</td> <td>803</td> <td>948</td> <td>1103</td> </tr> <tr> <td>B (mm)</td> <td>565</td> <td>715</td> <td>865</td> </tr> <tr> <td>C (mm)</td> <td>205</td> <td>200</td> <td>205</td> </tr> <tr> <td>D (mm)</td> <td>340</td> <td>416</td> <td>416</td> </tr> <tr> <td>Priključi na vodovodnu mrežu</td> <td>G 1/2</td> <td>G 1/2</td> <td>G 1/2</td> </tr> </tbody> </table>                                                                                                                                                                       | Model        | GBK 80 RN/LN  | GBK 100 RN/LN | GBK 120 RN/LN | A (mm)       | 803          | 948         | 1103 | B (mm) | 565 | 715 | 865  | C (mm) | 205                                                                    | 200 | 205 | D (mm) | 340 | 416    | 416 | Priključi na vodovodnu mrežu | G 1/2 | G 1/2 | G 1/2 | <p>01244</p> <p>01245</p> <p>01172</p> <p>01173</p> <p>01174</p> <p>01175</p> | <p>BOJLER 80 L KOMBINIRANI<br/>ZA CENTRALNO GRIJANJE<br/>ART. <b>GBK-080 D 580152</b></p> <p>BOJLER 80 L KOMBINIRANI<br/>ZA CENTRALNO GRIJANJE<br/>ART. <b>GBK-080 L 580153</b></p> <p>BOJLER 100 L KOMBINIRANI<br/>ZA CENTRALNO GRIJANJE<br/>ART. <b>GBK-100 RN D 580154</b></p> <p>BOJLER 100 L KOMBINIRANI<br/>ZA CENTRALNO GRIJANJE<br/>ART. <b>GTK/GBK-100 L 580155</b></p> <p>BOJLER 120 L KOMBINIRANI<br/>ZA CENTRALNO GRIJANJE<br/>ART. <b>GTK/GBK-120 D 580156</b></p> <p>BOJLER 120 L KOMBINIRANI<br/>ZA CENTRALNO GRIJANJE<br/>ART. <b>GTK/GBK-120 L 580157</b></p> |       |       |       |       |                               |                                                                                                                                                                                                     |
| Model                                                                                                                                                                                                                                                                                                                                                                                                                                                                                                                                                                                                                                                                                                                                                                                                                                                                                                         | GBK 80 RN/LN | GBK 100 RN/LN | GBK 120 RN/LN |               |              |              |             |      |        |     |     |      |        |                                                                        |     |     |        |     |        |     |                              |       |       |       |                                                                               |                                                                                                                                                                                                                                                                                                                                                                                                                                                                                                                                                                                |       |       |       |       |                               |                                                                                                                                                                                                     |
| A (mm)                                                                                                                                                                                                                                                                                                                                                                                                                                                                                                                                                                                                                                                                                                                                                                                                                                                                                                        | 803          | 948           | 1103          |               |              |              |             |      |        |     |     |      |        |                                                                        |     |     |        |     |        |     |                              |       |       |       |                                                                               |                                                                                                                                                                                                                                                                                                                                                                                                                                                                                                                                                                                |       |       |       |       |                               |                                                                                                                                                                                                     |
| B (mm)                                                                                                                                                                                                                                                                                                                                                                                                                                                                                                                                                                                                                                                                                                                                                                                                                                                                                                        | 565          | 715           | 865           |               |              |              |             |      |        |     |     |      |        |                                                                        |     |     |        |     |        |     |                              |       |       |       |                                                                               |                                                                                                                                                                                                                                                                                                                                                                                                                                                                                                                                                                                |       |       |       |       |                               |                                                                                                                                                                                                     |
| C (mm)                                                                                                                                                                                                                                                                                                                                                                                                                                                                                                                                                                                                                                                                                                                                                                                                                                                                                                        | 205          | 200           | 205           |               |              |              |             |      |        |     |     |      |        |                                                                        |     |     |        |     |        |     |                              |       |       |       |                                                                               |                                                                                                                                                                                                                                                                                                                                                                                                                                                                                                                                                                                |       |       |       |       |                               |                                                                                                                                                                                                     |
| D (mm)                                                                                                                                                                                                                                                                                                                                                                                                                                                                                                                                                                                                                                                                                                                                                                                                                                                                                                        | 340          | 416           | 416           |               |              |              |             |      |        |     |     |      |        |                                                                        |     |     |        |     |        |     |                              |       |       |       |                                                                               |                                                                                                                                                                                                                                                                                                                                                                                                                                                                                                                                                                                |       |       |       |       |                               |                                                                                                                                                                                                     |
| Priključi na vodovodnu mrežu                                                                                                                                                                                                                                                                                                                                                                                                                                                                                                                                                                                                                                                                                                                                                                                                                                                                                  | G 1/2        | G 1/2         | G 1/2         |               |              |              |             |      |        |     |     |      |        |                                                                        |     |     |        |     |        |     |                              |       |       |       |                                                                               |                                                                                                                                                                                                                                                                                                                                                                                                                                                                                                                                                                                |       |       |       |       |                               |                                                                                                                                                                                                     |
|    <table border="1" data-bbox="156 2020 809 2135"> <thead> <tr> <th>Model</th> <th>OGB 30 EL N</th> <th>OGB 50 EL N</th> <th>OGB 80 EL N</th> <th>OGB 100 EL N</th> <th>OGB 120 EL N</th> </tr> </thead> <tbody> <tr> <td>A (mm)</td> <td>510</td> <td>610</td> <td>830</td> <td>975</td> <td>1130</td> </tr> <tr> <td>B (mm)</td> <td>310</td> <td>400</td> <td>600</td> <td>750</td> <td>900</td> </tr> <tr> <td>C (mm)</td> <td>235</td> <td>240</td> <td>260</td> <td>255</td> <td>260</td> </tr> <tr> <td>Priključi na vodovodnu mrežu</td> <td>G 1/2</td> <td>G 1/2</td> <td>G 1/2</td> <td>G 1/2</td> <td>G 1/2</td> </tr> </tbody> </table> | Model        | OGB 30 EL N   | OGB 50 EL N   | OGB 80 EL N   | OGB 100 EL N | OGB 120 EL N | A (mm)      | 510  | 610    | 830 | 975 | 1130 | B (mm) | 310                                                                    | 400 | 600 | 750    | 900 | C (mm) | 235 | 240                          | 260   | 255   | 260   | Priključi na vodovodnu mrežu                                                  | G 1/2                                                                                                                                                                                                                                                                                                                                                                                                                                                                                                                                                                          | G 1/2 | G 1/2 | G 1/2 | G 1/2 | <p>0207048</p> <p>0207049</p> | <p>BOJLER 50 L EMAJLIRANI KAZAN,<br/>ELEKTRIČNO UPRAVLJANJE<br/>ART. <b>OGB 50 EDD 259959</b></p> <p>BOJLER 80 L EMAJLIRANI KAZAN,<br/>ELEKTRIČNO UPRAVLJANJE<br/>ART. <b>OGB 80 EDD 260046</b></p> |
| Model                                                                                                                                                                                                                                                                                                                                                                                                                                                                                                                                                                                                                                                                                                                                                                                                                                                                                                         | OGB 30 EL N  | OGB 50 EL N   | OGB 80 EL N   | OGB 100 EL N  | OGB 120 EL N |              |             |      |        |     |     |      |        |                                                                        |     |     |        |     |        |     |                              |       |       |       |                                                                               |                                                                                                                                                                                                                                                                                                                                                                                                                                                                                                                                                                                |       |       |       |       |                               |                                                                                                                                                                                                     |
| A (mm)                                                                                                                                                                                                                                                                                                                                                                                                                                                                                                                                                                                                                                                                                                                                                                                                                                                                                                        | 510          | 610           | 830           | 975           | 1130         |              |             |      |        |     |     |      |        |                                                                        |     |     |        |     |        |     |                              |       |       |       |                                                                               |                                                                                                                                                                                                                                                                                                                                                                                                                                                                                                                                                                                |       |       |       |       |                               |                                                                                                                                                                                                     |
| B (mm)                                                                                                                                                                                                                                                                                                                                                                                                                                                                                                                                                                                                                                                                                                                                                                                                                                                                                                        | 310          | 400           | 600           | 750           | 900          |              |             |      |        |     |     |      |        |                                                                        |     |     |        |     |        |     |                              |       |       |       |                                                                               |                                                                                                                                                                                                                                                                                                                                                                                                                                                                                                                                                                                |       |       |       |       |                               |                                                                                                                                                                                                     |
| C (mm)                                                                                                                                                                                                                                                                                                                                                                                                                                                                                                                                                                                                                                                                                                                                                                                                                                                                                                        | 235          | 240           | 260           | 255           | 260          |              |             |      |        |     |     |      |        |                                                                        |     |     |        |     |        |     |                              |       |       |       |                                                                               |                                                                                                                                                                                                                                                                                                                                                                                                                                                                                                                                                                                |       |       |       |       |                               |                                                                                                                                                                                                     |
| Priključi na vodovodnu mrežu                                                                                                                                                                                                                                                                                                                                                                                                                                                                                                                                                                                                                                                                                                                                                                                                                                                                                  | G 1/2        | G 1/2         | G 1/2         | G 1/2         | G 1/2        |              |             |      |        |     |     |      |        |                                                                        |     |     |        |     |        |     |                              |       |       |       |                                                                               |                                                                                                                                                                                                                                                                                                                                                                                                                                                                                                                                                                                |       |       |       |       |                               |                                                                                                                                                                                                     |



## GBFU SIMPLICITY - Tlačna električna grijalica vode

Nova generacija grijalica linije SIMPLICITY udružuje u sebi privlačan dizajn, jednostavnu uporabu i vrhunsku tehnologiju. Ergonomski oblikovani gumb omogućava jednostavno upravljanje tako što jednostavnim okretom omogućava brza namještanja najupotrebljavanije funkcije kao što je na primjer funkcija ECO ili namještanje protiv smrzavanja. Prema izboru, u bijeloj ili crnoj inačici.

Električna grijalica vode GBFU SIMPLICITY objedinjava u sebi sva tehnička rješenja klasične grijalice obitelji GB, zajedno s indirektnim cijevnim zračnim grijačima, vrhunski emajliranim kotlom i magn-ezijevo anodom. S izvornim tehničkim rješenjem grijaćeg dijela pobrinuli smo se da uporabivost i pouzdanost djelovanja bude još veća a održavanje jeftinije i jednostavnije. Grijalicu istovremeno krasi kompaktne dimenzije (promjer samo 454 mm) i njena univerzalna montaža budući je namijenjena za okomito ili ležeće pričvršćivanje na zid.



- Zapremnine: 50, 80, 100, 120 l.
- Pričvršćivanje vertikalno ili horizontalno na zid (priklučne cijevi s lijeve strane).
- Centralna opskrba dvaju ili više mjesta potrošnje.
- Indirektni cijevni zračni grijači.
- Kompaktne dimenzije (promjer samo 454 mm).
- Gumb za proizvoljno namještanje temperature vode do 75 °C.
- Mogućnost namještanja na ekonomičnu temperaturu i temperaturu zaštite od smrzavanja.
- Jednostavna montaža i održavanje.
- 2 godine opće garancije i 7 godina garancije na kotao.

| Šifra Vokel | Opis                                                      | Artikl |
|-------------|-----------------------------------------------------------|--------|
| 0207065     | BOJLER GBFU 50 SIM SIMPLICITY BIJELI UNIVERZALNA MONTAŽA  | 347137 |
| 0207062     | BOJLER GBFU 80 SIM SIMPLICITY BIJELI UNIVERZALNA MONTAŽA  | 347138 |
| 0207067     | BOJLER GBFU 100 SIM SIMPLICITY BIJELI UNIVERZALNA MONTAŽA | 347140 |



| MODEL                                                   | GBFU 50 SIM | GBFU 80 SIM | GBFU 100 SIM | GBFU 120 SIM |
|---------------------------------------------------------|-------------|-------------|--------------|--------------|
| Volumen [l]                                             | 50          | 80          | 100          | 120          |
| <b>NAMJENA</b>                                          |             |             |              |              |
| Jedno ili više mjesta potrošnje                         | ✓           | ✓           | ✓            | ✓            |
| Vertikalno pričvršćivanje na zid                        | ✓           | ✓           | ✓            | ✓            |
| Horizontalno pričvršćivanje na zid                      | ✓           | ✓           | ✓            | ✓            |
| Broj osoba - prosječna potrošnja                        | 2           | 3 - 4       | 4 - 5        | 5 - 6        |
| <b>PRIKLJUČNE MJERE</b>                                 |             |             |              |              |
| A [mm]                                                  | 583         | 803         | 948          | 1103         |
| B [mm]                                                  | 365         | 565         | 715          | 865          |
| C [mm]                                                  | 185         | 205         | 200          | 205          |
| D [mm]                                                  | 145         | 345         | 495          | 645          |
| Priključi na vodovodnu mrežu                            | G 1/2       | G 1/2       | G 1/2        | G 1/2        |
| Neto/ bruto masa/masa s vodom [kg]                      | 24/27/74    | 30/32/110   | 34/36/134    | 41/43/161    |
| <b>TEHNIČKA SVOJSTVA</b>                                |             |             |              |              |
| Radni tlak [bar]                                        | 6           | 6           | 6            | 6            |
| Kotao od čeličnog emajliranog lima                      | ✓           | ✓           | ✓            | ✓            |
| Zaštitna magnezijeva anoda                              | ✓           | ✓           | ✓            | ✓            |
| Biranje željene temperature do 75 °C                    | ✓           | ✓           | ✓            | ✓            |
| Zaštita od smrzavanja                                   | ✓           | ✓           | ✓            | ✓            |
| Signalno svjetlo - pokazivanje rada električnog grijača | ✓           | ✓           | ✓            | ✓            |
| Termometar                                              | ✓           | ✓           | ✓            | ✓            |
| Prosječna debljina izolacije [mm]                       | 17          | 17          | 17           | 17           |
| Šupari zaštite                                          | IP 24       | IP 24       | IP 24        | IP 24        |
| <b>ELEKTRIČNA SVOJSTVA</b>                              |             |             |              |              |
| Broj električnih grijača x snaga [W]                    | 2x1000      | 2x1000      | 2x1000       | 2x1000       |
| Priključna snaga [W]                                    | 2000        | 2000        | 2000         | 2000         |
| Napon 230 V -                                           | ✓           | ✓           | ✓            | ✓            |
| Nazivna struja [A]                                      | 8,7         | 8,7         | 8,7          | 8,7          |
| <b>FUNKCIONALNA SVOJSTVA</b>                            |             |             |              |              |
| Vrijeme zagrijavanja od 15 do 75 °C                     | 1h 55min    | 3h 05 min   | 3h 55 min    | 4h 35 min    |
| Količina miješane vode kod 40 °C [l] <sup>1)</sup>      | 96/80       | 151/130     | 199/174      | 238/210      |
| Toplinski gubici [kWh/24h] <sup>2)</sup>                | 1,32/1,45   | 1,85/2,10   | 2,20/2,45    | 2,60/2,90    |
| <b>TRANSPORTNI PODACI</b>                               |             |             |              |              |
| Mjere ambalaže [mm]                                     | 480x490x635 | 480x490x835 | 480x490x980  | 480x490x1135 |

<sup>1)</sup> Vrijednosti vrijede za miješanje vode iz vodovoda 15 °C i vode iz grijalice kada je u njoj sva voda zagrijana na 65 °C (stand. mjereno kod temperature okoline 20 °C i temperature vode u grijalici 65 °C (standardi SIST EN 60379:2005)).  
<sup>2)</sup> Kod tlačnog priključivanja obvezna je uporaba sigurnosnog ventila.

Pogled sa strane

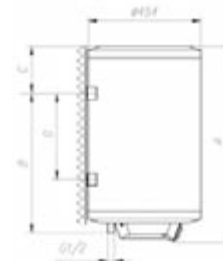

Pogled s prija

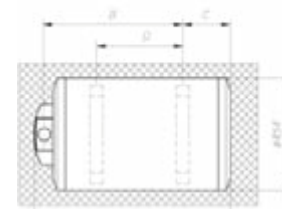

Pogled odozgor

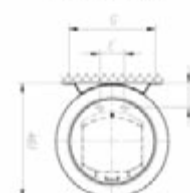

## OTG SLIM SIMPLICITY - Tlačna električna grijalica vode

Klasičnu grijalicu vode OTG SLIM, karakterističnu po suvremenom i estetski uglatom dizajnu, nadogradili smo linijom SIMPLICITY. Grijalici smo dodali elegantan, ergonomski oblikovani gumb koji pomoću zornih simbola označava četiri najčešće upotrebljavana programa. Igra bijele i crne boje dodatno naglašava njegov estetski oblik i time doprinosi elegantnom izgledu vaše kupaonice.

Kao i kod ostalih grijalica vode obitelji OTG tako i grijalice OTG SLIM SIMPLICITY označavaju kvalitetni bakreni električni grijači i male vanjske dimenzije koje omogućavaju ugradnju i tamo gdje manjka prostor. Obloga grijalice izrađena je od visokokvalitetnog lakiranog lima a unutrašnjost grijalice vrhunski je emajlirana što u kombinaciji s magnezijevom anodom omogućava odličnu zaštitu od korozije i manje nakupljanje kamenca. Odlična izolacija od poliuretanske pjene vodi brigu o minimalnom gubitku topline. Grijalica je namijenjena isključivo okomitom pričvršćivanju na zid.



- Zapremnine: 30, 50, 80, 100, 120 l.
- Montaža vertikalno na zid.
- Centralna opskrba dvaju ili više mjesta potrošnje.
- Izvorni uglati dizajn.
- Kompaktne dimenzije.
- Kvalitetna izolacija omogućava manje gubitke topline.
- Gumb za namještanje temperature vode do 75 °C.
- Mogućnost namještanja na ekonomičnu temperaturu i temperaturu zaštite od smrzavanja.
- Prikaz djelovanja električnog grijača.
- Jednostavna montaža i održavanje.
- 2 godine opće garancije i 5 godina garancije na kotao.

| Šifra Vokel | Opis                                               | Artikl |
|-------------|----------------------------------------------------|--------|
| 0207064     | BOJLER OTG 50 SL SIM SIMPLICITY BIJELE VERTIKALNI  | 347062 |
| 0207063     | BOJLER OTG 80 SL SIM SIMPLICITY BIJELE VERTIKALNI  | 347063 |
|             | BOJLER OTG 100 SL SIM SIMPLICITY BIJELE VERTIKALNI | 347065 |



| MODEL                                                    | OTG 30 SLSIM | OTG 50 SLSIM | OTG 80 SLSIM | OTG 100 SLSIM | OTG 120 SLSIM |
|----------------------------------------------------------|--------------|--------------|--------------|---------------|---------------|
| Volumen [l]                                              | 30           | 50           | 80           | 100           | 120           |
| <b>NAMJENA</b>                                           |              |              |              |               |               |
| Jedno ili više mjesta potrošnje                          | ✓            | ✓            | ✓            | ✓             | ✓             |
| Vertikalno pričvršćivanje na zid                         | ✓            | ✓            | ✓            | ✓             | ✓             |
| Broj osoba - prosječna potrošnja                         | 1            | 2            | 3 - 4        | 4 - 5         | 5 - 6         |
| <b>PRIKLJUČNE MJERE</b>                                  |              |              |              |               |               |
| A [mm]                                                   | 510          | 690          | 950          | 1125          | 1300          |
| B [mm]                                                   | 310          | 470          | 735          | 900           | 900           |
| C [mm]                                                   | 235          | 250          | 245          | 225           | 430           |
| Priključci na vodovodnu mrežu                            | G 1/2        | G 1/2        | G 1/2        | G 1/2         | G 1/2         |
| Neto/ bruto masa/masa s vodom [kg]                       | 19/21/49     | 24/26/74     | 31/33/111    | 36/38/136     | 41/43/161     |
| <b>TEHNIČKA SVOJSTVA</b>                                 |              |              |              |               |               |
| Radni tlak [bar]                                         | 6            | 6            | 6            | 6             | 6             |
| Kotao od čeličnog emajliranog lima                       | ✓            | ✓            | ✓            | ✓             | ✓             |
| Zaštitna magnezijeva anoda                               | ✓            | ✓            | ✓            | ✓             | ✓             |
| Biranje željene temperature do 75 °C                     | ✓            | ✓            | ✓            | ✓             | ✓             |
| Zaštita od smrzavanja                                    | ✓            | ✓            | ✓            | ✓             | ✓             |
| Signalno svjetlo - prikaz djelovanja električnog grijača | ✓            | ✓            | ✓            | ✓             | ✓             |
| Prosječna debljina izolacije [mm]                        | 20 - 60      | 20 - 60      | 20 - 60      | 20 - 60       | 20 - 60       |
| Stupanj zaštite                                          | IP 24        | IP 24        | IP 24        | IP 24         | IP 24         |
| <b>ELEKTRIČNA SVOJSTVA</b>                               |              |              |              |               |               |
| Priključna snaga [W]                                     | 2000         | 2000         | 2000         | 2000          | 2000          |
| Napon 230 V -                                            | ✓            | ✓            | ✓            | ✓             | ✓             |
| Nazivna struja [A]                                       | 8.7          | 8.7          | 8.7          | 8.7           | 8.7           |
| <b>FUNKCIONALNA SVOJSTVA</b>                             |              |              |              |               |               |
| Vrijeme zagrijavanja od 15 do 75 °C                      | 1h 05min     | 1h 55min     | 3h 05min     | 3h 55min      | 4h 35min      |
| Količina miješane vode kod 40 °C [l] <sup>1)</sup>       | 50           | 89           | 145          | 200           | 236           |
| Toplinski gubitci [kWh/24h] <sup>2)</sup>                | 0.69         | 0.94         | 1.30         | 1.54          | 1.79          |
| <b>TRANSPORTNI PODATCI</b>                               |              |              |              |               |               |
| Mjere ambalaže [mm]                                      | 480x490x630  | 480 x490x810 | 480x490x1070 | 480x490x1245  | 480x490x1420  |

Pogled srijeda



Pogled sa strane



<sup>1)</sup> Vrijednosti vrijede za miješanje vode iz vodovoda 15 °C i vode iz grijalice kada je u njoj sva voda zagrijana na 65 °C (standard SIST EN 60379:2005).

<sup>2)</sup> Mjereno kod temperature okoline 20 °C i temperature vode u grijalici 65 °C (standard SIST EN 60379:2005).

\* Kod tačnog priključivanja obavezna je uporaba sigurnosnog ventila

## Inox bojler BT



Kazan od nehrđajućeg čelika predstavlja idealno rješenje za skladištenje vode. Inoxni materijal je fiziološki neutralan, kemijski ne reagira sa vodom a samim tim doprinosi očuvanju njene kvalitete. Bojleri sa kazanom ove vrste doprinosi očuvanju vašeg zdravlja. Primjenom suvremenih tehnologija na području termičke izolacije i upotrebom poliuretanske pjene uspjeli smo da gubitke u toplotnoj energiji svedemo na minimum a samim tim povećamo uštedu električne energije

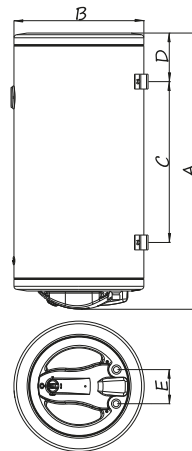

| Model                              | BT-50 | BT-80 |
|------------------------------------|-------|-------|
| Zapremina [l]                      | 50    | 80    |
| Pritisak [MPa]                     | 0,6   |       |
| Snaga grijača [W]                  | 2000  |       |
| Vrijeme zagrijavanja do 75°C [min] | 141   | 175   |
| Radni napon [V]                    | 230   |       |
| Priključci                         | 1/2"  | 1/2"  |
| A [mm]                             | 620   | 900   |
| B [mm]                             | 420   | 420   |
| C [mm]                             | 230   | 520   |
| D [mm]                             | 169   | 157   |
| E [mm]                             | 110   | 110   |
| F [mm]                             | 106   | 106   |

| Š.Vokel | Opis                                                       | Artikl        |
|---------|------------------------------------------------------------|---------------|
| 0226001 | ELEKTRIČNI BOJLER TERMORAD BT-50 BIJELE 50 Lit. VERTIKALNI | 8606007730432 |
| 0226002 | ELEKTRIČNI BOJLER TERMORAD BT-80 BIJELE 80 Lit. VERTIKALNI | 8606007731071 |

## Inox bojler BT-50 IB-21 sa izmjenjivačem topline



U skladu sa suvremenim trendovima u oblasti očuvanja energije i njene racionalne upotrebe konstruirali smo bojler sa izmjenjivačem topline. Ovaj tip bojlera omogućava upotrebu tople vode iz sistema centralnog grijanja ili iz kolektora sunčeve energije za zagrijavanje vode u inox kazanu. Na ovaj način ostvaruju se velike uštede u električnoj energiji.

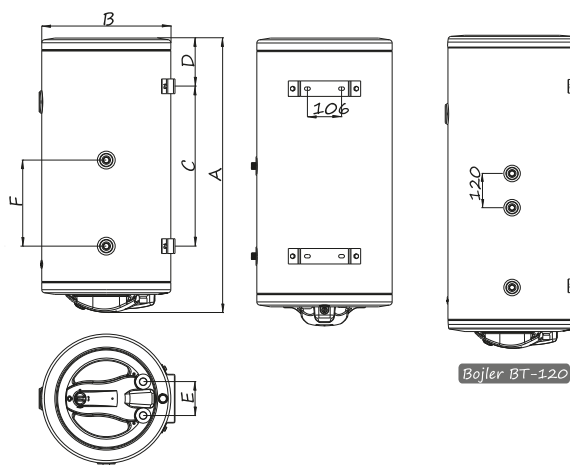

| Model                          | BT-50 IB | BT-60 IB | BT-80 IB | BT-120 IB |
|--------------------------------|----------|----------|----------|-----------|
| Zapremina [l]                  | 50       | 60       | 80       | 120       |
| Pritisak [MPa]                 | 0,6      |          |          |           |
| Snaga grejača [W]              | 2000     |          |          |           |
| Vreme zagrevanja do 75°C [min] | 141      | 159      | 175      | 260       |
| Radni napon [V]                | 230      |          |          |           |
| Priključci                     | 1/2"     |          |          |           |
| Priključak izmjenjivača        | 1/2"     |          |          |           |
| A [mm]                         | 620      | 700      | 900      | 1108      |
| B [mm]                         | 420      | 420      | 420      | 450       |
| C [mm]                         | 230      | 300      | 520      | 700       |
| D [mm]                         | 169      | 178      | 157      | 179       |
| E [mm]                         | 110      | 110      | 110      | 110       |
| F [mm]                         | 150      | 250      | 280      | 390       |

| Š.Vokel | Opis                                                                                        | Artikl        |
|---------|---------------------------------------------------------------------------------------------|---------------|
| 0226003 | ELEKTRIČNI BOJLER TERMORAD BT-50 IB-21 LIJEVI BIJELE 50 Lit. VERTIKALNI                     | 8606007730449 |
| 0226004 | ELEKTRIČNI BOJLER TERMORAD BT-50 IB-21 DESNI BIJELE 50 Lit. VERTIKALNI                      | 8606007730463 |
| 0226005 | ELEKTRIČNI BOJLER TERMORAD BT-80 IB-21 LIJEVI BIJELE 80 Lit. VERTIKALNI                     | 8606007731088 |
| 0226006 | ELEKTRIČNI BOJLER TERMORAD BT-80 IB-21 DESNI BIJELE 80 Lit. VERTIKALNI                      | 8606007731101 |
| 0226007 | ELEKTRIČNI BOJLER TERMORAD BT-120 IB-30 LIJEVI BIJELE 120 Lit. VERTIKALNI SA RECIRKULACIJOM | 8606007731408 |
| 0226008 | ELEKTRIČNI BOJLER TERMORAD BT-120 IB-30 DESNI BIJELE 120 Lit. VERTIKALNI SA RECIRKULACIJOM  | 8606007731422 |
| 0226020 | ELEKTRIČNI BOJLER TERMORAD BT-120S IB-30 LIJEVI BIJELE 120 Lit. STOJEĆI                     | 8606007731477 |
| 0226021 | ELEKTRIČNI BOJLER TERMORAD BT-120S IB-30 DESNI BIJELE 120 Lit. STOJEĆI                      | 8606007731491 |







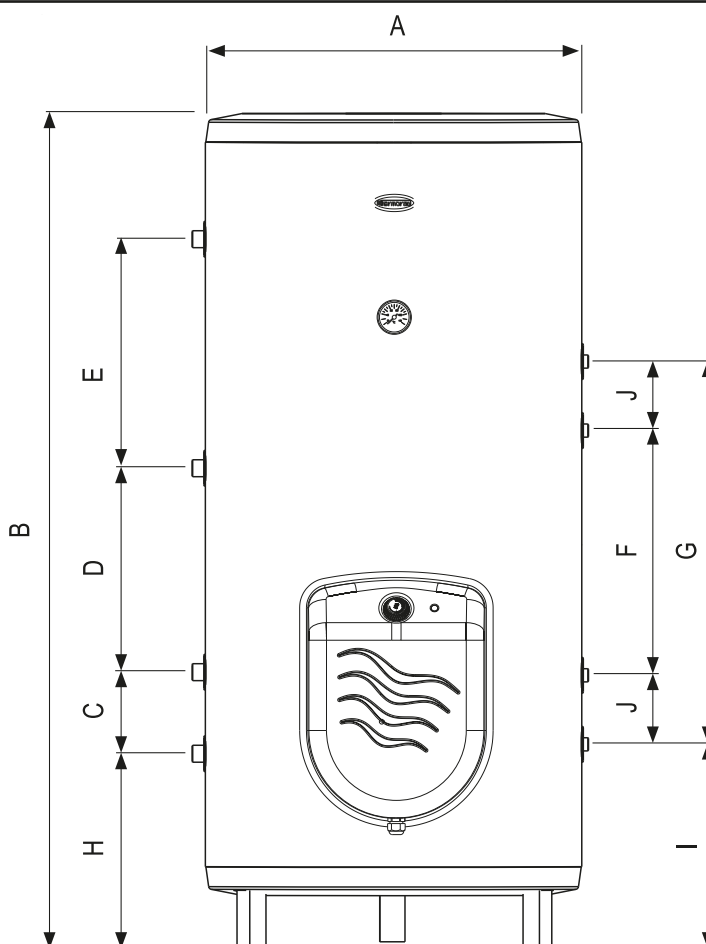

## Inox bojler velike litraže solarni BT-200, 280 S IB-80 stojeći

Iz našeg širokog asortimana izdvajamo bojlere većih zapremina od 200l, 280l i 500l. Pored toga što su znatno veće litraže ove bojlere izdvaja i to što mogu biti sa dva izmenjivača topline.

| Š.Vokel | Opis                                                                                    | Artikl        |
|---------|-----------------------------------------------------------------------------------------|---------------|
| 0226009 | ELEKTRIČNI BOJLER TERMORAD BT-200 S IB-80 SILVER METALLIC 200 Lit. DESNI                | 8606007732146 |
| 0226010 | ELEKTRIČNI BOJLER TERMORAD BT-280 S IB-80 SILVER METALLIC 280 Lit. DESNI                | 8606007732207 |
| 0226018 | ELEKTRIČNI BOJLER TERMORAD BT-200 S IB-80+50 SILVER METALLIC 200 Lit. DESNI (2 SPIRALE) | 8606007732160 |
| 0226019 | ELEKTRIČNI BOJLER TERMORAD BT-280 S IB-80+50 SILVER METALLIC 280 Lit. DESNI (2 SPIRALE) | 8606007732221 |

| Model                          | BT-160 | BT-200 | BT-280 |
|--------------------------------|--------|--------|--------|
| Zapremina [l]                  | 160    | 200    | 280    |
| Pritisak [MPa]                 | 0,6    |        |        |
| Snaga grejača [W]              | 3000   | 6000   |        |
| Vreme zagrevanja do 75°C [min] |        | 170    | 230    |
| Radni napon [V]                | 230    |        |        |
| Priključci za vodu             | 3/4"   |        |        |
| Priključak za recirkulaciju    | 3/4"   |        |        |
| Priključak izmenjivača         | 1/2"   |        |        |
| Debljina izolacije [cm]        | 40     | 50     | 50     |
| A [mm]                         | 500    | 600    | 600    |
| B [mm]                         | 1370   | 1335   | 1705   |
| C [mm]                         | 130    | 130    | 130    |
| D [mm]                         | 465    | 300    | 520    |
| E [mm]                         | 445    | 390    | 540    |
| F [mm]                         | 390    | 390    | 390    |
| G [mm]                         |        | 610    | 610    |
| H [mm]                         | 255    | 305    | 305    |
| I [mm]                         | 325    | 320    | 320    |
| J [mm]                         |        | 110    | 110    |



|                                                                                     | Š.Vokel | Opis                                     |
|-------------------------------------------------------------------------------------|---------|------------------------------------------|
|    | 0226015 | TERMOSTAT RADNI<br>ART.32740             |
|    | 0226016 | TERMOSTAT ZAŠTITNI<br>ART.32757          |
|   | 0226017 | TERMOSTAT RADNI TROFAZNI<br>ART.34294    |
|  | 0226014 | INDIKATOR TEMPERATURE                    |
|  | 0226011 | ELEKTRIČNI GRIJAČ BOJLERA BT 2000W       |
|  | 0226012 | ELEKTRIČNI GRIJAČ BOJLERA BT 200/280/500 |





## Zidni električni bojler

- UNIKATNI DIZAJN
- SPREMAN ZA TUŠIRANJE
- ECO FUNKCIJA
- DVIJE MAGNEZIJSKE ANODE
- DVIJE PRIRUBNICE S 5 VIJAKA
- DEBELA TOPLINSKA IZOLACIJA
- SIGURNOSNI TLAČNI VENTIL TESTIRAN NA 8 BARA
- MAKSIMALNI KOMFOR
- LED ZASLON
- INSTALACIJA U VIŠE POLOŽAJA



| Š.Vokel | Opis                                         | Artikl  |
|---------|----------------------------------------------|---------|
| 0211069 | ELEKTRIČNI BOJLER ARISTON VELIS VLS 50 Lit.  | 3605216 |
| 0211070 | ELEKTRIČNI BOJLER ARISTON VELIS VLS 80 Lit.  | 3605217 |
| 0211071 | ELEKTRIČNI BOJLER ARISTON VELIS VLS 100 Lit. | 3605218 |

### SPREMAN ZA TUŠIRANJE

Sustav zahvaljujući svojoj specifičnoj unutarnjoj strukturi s 2 odvojena spremnika, omogućuje najbolju stratifikaciju vode, smanjujući vrijeme zagrijavanja za 1. tuširanje. Velis Vam osigurava više slobodnog vremena smanjenjem vremena čekanja u usporedbi s uobičajenim bojlerom.



Na osnovi kapaciteta Velis uređaja kojeg posjedujete, možete uštedjeti:

- 15 min ako imate 50 l (znači 21% ušteda vremena)
- 1 sat ako imate 80 l (51% ušteda vremena)
- 1,30 sati ako imate 100 l Velis (60% ušteda vremena)

S ovom novom ponudom bojlera, Ariston Vam osigurava više slobodnog vremena i posebnu pozornost usmjerava na potrošnju električne energije.

### PAMETNI TERMOMETAR

Novi ponuda osigurava pouzdani prikaz za jednostavnu uporabu. Velis prikazuje temperaturu na elegantnom LED zaslonu u svijetlo plavoj boji. Nadalje, Velis Premium za programiranje postavki i eco funkcije ima LCD plus zaslon osjetljiv na dodir. Doboje također imaju indikaciju greške s kodom za jednostavno održavanje. Okvir u svijetlo sivij boji kroma ovim proizvodima daje elegantni izgled.



## Tehnički podaci - Ukupne dimenzije

|                                                    | VELIS       |                     |                     | VELIS               |      |      |
|----------------------------------------------------|-------------|---------------------|---------------------|---------------------|------|------|
|                                                    | VLS 50      | VLS 80              | VLS 100             | 50                  | 80   | 100  |
| Kapacitet                                          | l           | 50                  | 80                  | 100                 |      |      |
| Instalacija                                        |             | Više položaja (V/H) | Više položaja (V/H) | Više položaja (V/H) |      |      |
| Snaga                                              | kW          | 1,5                 | 1,5                 | 1,5                 | a mm | 800  |
| Napon                                              | V           | 230                 | 230                 | 230                 | b mm | 405  |
| **Vrijeme zagrij. * $(\Delta T=45^{\circ}C)$ h,min |             | 2,02                | 2,56                | 3,42                |      | 1090 |
| Maks. radni tlak                                   | bar         | 8                   | 8                   | 8                   |      | 1275 |
| Maks. radna temperatura                            | $^{\circ}C$ | 80                  | 80                  | 80                  |      | 880  |
| Težina                                             | kg          | 20                  | 26                  | 30                  |      |      |
| Klasa                                              | IP          | IPX4                | IPX4                | IPX4                |      |      |
| * izlazni spremnik                                 |             |                     |                     |                     |      |      |
| ** puni kapacitet                                  |             |                     |                     |                     |      |      |
|                                                    |             | VLS 50              | VLS 80              | VLS 100             |      |      |
|                                                    |             | 3605216             | 3605217             | 3605218             |      |      |

\* S utikačem i kabelom [PL]

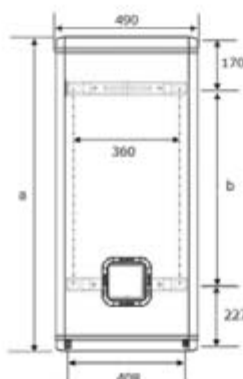

#### LEGENDA

- E** Ulaz hladne vode G 1/2"
- U** Izlaz tople vode G 1/2"

# SHAPE ECO

## Zidni električni bojler



- INOVATIVNI DIZAJN
- VISOKO PRECIZNI NTC TEMP. OSJETNICI
- JEDNOSTAVNO I BRZO RESETIRANJE
- PRIRUBNICA S 5 VIJAKA
- DEBELA TOPLINSKA IZOLACIJA
- VELIKA MAGNEZIJSKA ANODA
- VISOKA UČINKOVITOST PROŠIRENA S POLIURETANSKOM IZOLACIJOM
- SIGURNOSNI TLAČNI VENTIL TESTIRAN NA 8 BARA
- PROIZVOD JE TESTIRAN PREMA NAJVIŠIM STANDARDIMA KVALITETE
- UNUTARNJI SPREMNIK EMAJLIRAN TITANIJEM TESTIRAN NA 16 BARA
- MAKSIMALNI KOMFOR

| Š.Vokel | Opis                                                                          | Artikl  |
|---------|-------------------------------------------------------------------------------|---------|
| 0211063 | ELEKTRIČNI BOJLER ARISTON SHAPE ECO 50V 1,8K S VANJSKOM REGULACIJOM 50 Lit.   | 3605141 |
| 0211064 | ELEKTRIČNI BOJLER ARISTON SHAPE ECO 80V 1,8K S VANJSKOM REGULACIJOM 80 Lit.   | 3605143 |
| 0211065 | ELEKTRIČNI BOJLER ARISTON SHAPE ECO 100V 1,8K S VANJSKOM REGULACIJOM 100 Lit. | 3605144 |

**+10%**  
ušteta  
energije

SHAPE ECO novi je Aristonov proizvodni zaštitni znak koji kombinira najmoderniju ECO tehnologiju, Nanomix+Best sustav i ABS sigurnosnu ponudu s novim dizajnom. S novom ECO funkcijom SHAPE ECO korisniku omogućuje uštedu energije do 10%. S Nanomix+Best sustavom proizvod može proizvesti do 40 l vode na 40°C više od tradicionalnih bojlera. ABS ponuda nudi maksimalnu sigurnost za korisnika i proizvod. Nadalje, prednja LED upravljačka ploča s novim Smart termometrom ovaj proizvod zaista čini inovativnim.

### Tehnički podaci - ukupne dimenzije

|                           | SHAPE ECO  |  |            |            |            |            |            |            |            |      | SHAPE ECO |     |           |     |           |     |     |     |     |     |     |  |      |  |     |  |     |  |     |  |      |
|---------------------------|------------|--|------------|------------|------------|------------|------------|------------|------------|------|-----------|-----|-----------|-----|-----------|-----|-----|-----|-----|-----|-----|--|------|--|-----|--|-----|--|-----|--|------|
|                           | 50 V 1,8K  |  | 65 V 1,8K  |            | 80 V 1,8K  |            | 100 V 1,8K |            | 50 H 1,8K  |      | 65 H 1,8K |     | 80 H 1,8K |     | 100H 1,8K |     | 50V |     | 65V |     | 80V |  | 100V |  | 50H |  | 65H |  | 80H |  | 100H |
| Kapacitet                 | l          |  | 50         | 65         | 80         | 100        | 50         | 65         | 80         | 100  | a         |     | 570       | 686 | 775       | 927 | 570 | 686 | 775 | 927 |     |  |      |  |     |  |     |  |     |  |      |
| Instalacija               | V          |  | V          | V          | V          | H          | H          | H          | H          | b    |           | 379 | 501       | 584 | 736       | 164 | 248 | 331 | 483 |     |     |  |      |  |     |  |     |  |     |  |      |
| TD/TS                     | -          |  | -          | -          | -          | -          | -          | -          | -          | c    |           | 191 | 185       | 191 | 191       | 172 | 186 | 191 | 191 |     |     |  |      |  |     |  |     |  |     |  |      |
| Veličina                  | Uobičajena |  | Uobičajena | Uobičajena | Uobičajena | Uobičajena | Uobičajena | Uobičajena | Uobičajena |      |           |     |           |     |           |     |     |     |     |     |     |  |      |  |     |  |     |  |     |  |      |
| Snaga                     | kW         |  | 1,8        | 1,8        | 1,8        | 1,8        | 1,8        | 1,8        | 1,8        |      |           |     |           |     |           |     |     |     |     |     |     |  |      |  |     |  |     |  |     |  |      |
| Napon                     | V          |  | 230        | 230        | 230        | 230        | 230        | 230        | 230        |      |           |     |           |     |           |     |     |     |     |     |     |  |      |  |     |  |     |  |     |  |      |
| Vrijeme zagrij. [ΔT=45°C] | h:min      |  | 1:32       | 1:59       | 2:27       | 3:03       | 1:32       | 1:59       | 2:27       | 3:03 |           |     |           |     |           |     |     |     |     |     |     |  |      |  |     |  |     |  |     |  |      |
| Toplinski gubici kod 65°C | kWh/24h    |  | 0,8        | 0,87       | 0,94       | 1,08       | 0,85       | 1          | 1,14       | 1,25 |           |     |           |     |           |     |     |     |     |     |     |  |      |  |     |  |     |  |     |  |      |
| Maks. radni tlak          | bar        |  | 8          | 8          | 8          | 8          | 8          | 8          | 8          |      |           |     |           |     |           |     |     |     |     |     |     |  |      |  |     |  |     |  |     |  |      |
| Maks. radna temperatura   | °C         |  | 80         | 80         | 80         | 80         | 80         | 80         | 80         |      |           |     |           |     |           |     |     |     |     |     |     |  |      |  |     |  |     |  |     |  |      |
| Težina                    | kg         |  | 19         | 21         | 23,5       | 27         | 19         | 21         | 23,5       | 27   |           |     |           |     |           |     |     |     |     |     |     |  |      |  |     |  |     |  |     |  |      |
| Klasa                     | IP         |  | IPX4       | IPX4       | IPX4       | IPX4       | IPX4       | IPX4       | IPX4       |      |           |     |           |     |           |     |     |     |     |     |     |  |      |  |     |  |     |  |     |  |      |

| SHP ECO 50 V 1,8K | SHP ECO 65 V 1,8K | SHP ECO 80 V 1,8K | SHP ECO 100 V 1,8K | SHP ECO 50 H 1,8K | SHP ECO 65 H 1,8K | SHP ECO 80 H 1,8K | SHP ECO 100 H 1,8K |
|-------------------|-------------------|-------------------|--------------------|-------------------|-------------------|-------------------|--------------------|
| * 3605141         | 3605142           | 3605143           | 3605144            | 3605145           | 3605146           | 3605147           | 3605148            |

\* S utikačem i kabelom IPL

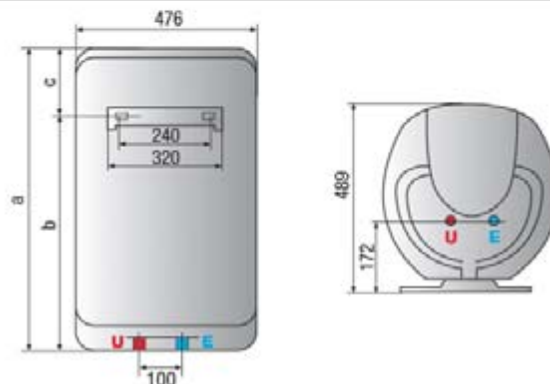

#### LEGENDA

- E** Ulaz hladne vode G 1/2"
- U** Izlaz tople vode G 1/2"

# PRO ECO



## Zidni električni bojler

- EKSKLUZIVAN DIZAJN
- VISOKO PRECIZNI NTC TEMP. OSJETNICI
- JEDNOSTAVNO I BRZO RESETIRANJE
- VELIKA MAGNEZIJSKA ANODA
- VISOKA UČINKOVITOST S DODATNOM POLIURETANSKOM IZOLACIJOM
- SIGURNOSNI TLAČNI VENTIL TESTIRAN NA 8 BARA
- PROIZVOD JE TESTIRAN PREMA NAJVIŠIM STANDARDIMA KVALITETE
- UNUTARNJI SPREMNIK EMAJLIAN TITANIJEM TESTIRAN NA 16 BARA

| Š.Vokel | Opis                                                                      | Artikl  |
|---------|---------------------------------------------------------------------------|---------|
| 11505   | ELEKTRIČNI BOJLER ARISTON PRO ECO 50V 2K S VANJSKOM REGULACIJOM 50 Lit.   | 3200477 |
| 11493   | ELEKTRIČNI BOJLER ARISTON PRO ECO 80V 2K S VANJSKOM REGULACIJOM 80 Lit.   | 3200478 |
| 11932   | ELEKTRIČNI BOJLER ARISTON PRO ECO 100V 2K S VANJSKOM REGULACIJOM 100 Lit. | 3200479 |

**Ekskluzivan dizajn**

**+10%**  
ušteđa energije

PRO ECO najbolje je rješenje za korisnika koji želi proizvod koji može garantirati maksimalne uštede i istovremeno maksimalne radne karakteristike uz maksimalnu sigurnost. Zahvaljujući ECO tehnologiji, Nanomix+Best sustavu i ABS paketu, PRO ECO korisniku omogućava godišnju uštedu energije do 10% uz proizvodnju do 40 l više vode zagrijane na 40°C, te nudi maksimalnu sigurnost. PRO ECO ima novi dizajn: Smart termometar nalazi se na prednjoj led upravljačkoj ploči.

## Tehnički podaci - ukupne dimenzije

|                           |                  | PRO ECO    |            |            | PRO ECO |     |     |     |
|---------------------------|------------------|------------|------------|------------|---------|-----|-----|-----|
|                           |                  | 50 V 2K    | 80 V 2K    | 100 V 2K   | 50      | 80  | 100 |     |
| Kapacitet                 | l                | 50         | 80         | 100        |         |     |     |     |
| Instalacija               | V                | V          | V          | V          | a mm    | 550 | 758 | 913 |
| TD/TS                     | -                | -          | -          | -          | b mm    | 298 | 603 | 758 |
| Veličina                  |                  | Uobičajena | Uobičajena | Uobičajena |         |     |     |     |
| Snaga                     | kW               | 2          | 2          | 2          |         |     |     |     |
| Napon                     | V                | 230        | 230        | 230        |         |     |     |     |
| Vrijeme zagrij (ΔT=45°C)  | h <sub>min</sub> | 1:22'      | 2:12'      | 2:45'      |         |     |     |     |
| Toplinski gubici kod 65°C | kWh/24h          | 0,96       | 1,22       | 1,39       |         |     |     |     |
| Maks. radni tlak          | bar              | 8          | 8          | 8          |         |     |     |     |
| Maks. radna temperatura   | °C               | 80         | 80         | 80         |         |     |     |     |
| Težina                    | kg               | 16,5       | 22         | 25,5       |         |     |     |     |
| Klasa                     | IP               | IPX3       | IPX3       | IPX3       |         |     |     |     |

PRO ECO 50 V 2K  
3200477

PRO ECO 80 V 2K  
3200478

PRO ECO 100 V 2K  
3200479

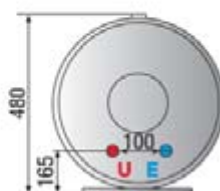
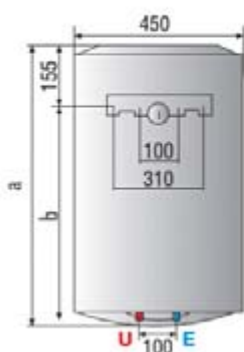

### LEGENDA

- E** Ulaz hladne vode G 1/2"
- U** Izlaz tople vode G 1/2"

# PRO R



## Zidni električni bojler

- EKSKLUZIVAN DIZAJN
- VELIKA KOLIČINA TOPLE VODE
- NOVI SNAŽNI TERMOMETAR
- TERMOSTAT S BIPOLARNIM SIGURNOSNIM UREĐAJEM
- VELIKA MAGNEZIJSKA ANODA
- VISOKA UČINKOVITOST PROŠIRENA S POLIURETANSKOM IZOLACIJOM
- SIGURNOSNI TLAČNI VENTIL TESTIRAN NA 8 BARA
- PROIZVOD JE TESTIRAN PREMA NAJVIŠIM STANDARDIMA KVALITETE
- EMAJLIKAN UNUTARNJI SPREMNIK TESTIRAN NA 16 BARA

| Š.Vokel | Opis                                                                               | Artikl  |
|---------|------------------------------------------------------------------------------------|---------|
| 11526   | ELEKTRIČNI BOJLER ARISTON PRO R 50V 2K S VANJSKOM REGULACIJOM 50 Lit. VERTIKALNI   | 3200382 |
| 11528   | ELEKTRIČNI BOJLER ARISTON PRO R 80V 2K S VANJSKOM REGULACIJOM 80 Lit. VERTIKALNI   | 3200383 |
| 11562   | ELEKTRIČNI BOJLER ARISTON PRO R 100V 2K S VANJSKOM REGULACIJOM 100 Lit. VERTIKALNI | 3200384 |
|         | ELEKTRIČNI BOJLER ARISTON PRO R 80H 2K S VANJSKOM REGULACIJOM 80 Lit. HORIZONTALNI | 3200475 |

|         |                                                              |         |
|---------|--------------------------------------------------------------|---------|
| 11511   | KOMBINIRANI BOJLER ARISTON PRO R 80VTD 1,8K DESNI 80 Lit.    | 3200401 |
| 11512   | KOMBINIRANI BOJLER ARISTON PRO R 80VTS 1,8K LIJEVI 80 Lit.   | 3200402 |
| 0211054 | KOMBINIRANI BOJLER ARISTON PRO R 100VTD 1,8K DESNI 100 Lit.  | 3200403 |
| 0211055 | KOMBINIRANI BOJLER ARISTON PRO R 100VTS 1,8K LIJEVI 100 Lit. | 3200404 |

## Tehnički podaci - ukupne dimenzije

|                           | PRO R   |           |           |           |          |             |             |              |              |       | PRO R |     |      |     |      |       |       |        |        |     |
|---------------------------|---------|-----------|-----------|-----------|----------|-------------|-------------|--------------|--------------|-------|-------|-----|------|-----|------|-------|-------|--------|--------|-----|
|                           | 50 V 2K | 80 V 2K   | 100 V 2K  | 80 H 2K   | 100 H 2K | 80 VTD 1,8K | 80 VTS 1,8K | 100 VTD 1,8K | 100 VTS 1,8K |       | 50V   | 80V | 100V | 80H | 100H | 80VTD | 80VTS | 100VTD | 100VTS |     |
| Kapacitet                 | l       | 50        | 80        | 100       | 80       | 100         | 80          | 80           | 100          | 100   |       |     |      |     |      |       |       |        |        |     |
| Instalacija               | V       | V         | V         | H         | H        | V           | V           | V            | V            | V     | a mm  | 553 | 758  | 913 | 758  | 913   | 758   | 758    | 913    | 913 |
| TD/TS                     | -       | -         | -         | -         | -        | TD          | TS          | TD           | TS           |       | b mm  | 398 | 603  | 758 | -    | -     | 603   | 603    | 758    | 758 |
| Veličina                  | Uobič.  | Uobič.    | Uobič.    | Uobič.    | Uobič.   | Uobič.      | Uobič.      | Uobič.       | Uobič.       |       | c mm  | -   | -    | -   | 174  | 177   | -     | -      | -      | -   |
| Snaga                     | kW      | 2         | 2         | 2         | 2        | 2           | 1,8         | 1,8          | 1,8          | 1,8   |       |     |      |     |      |       |       |        |        |     |
| Napon                     | V       | 230       | 230       | 230       | 230      | 230         | 230         | 230          | 230          | 230   |       |     |      |     |      |       |       |        |        |     |
| Vrijeme zagrij. ΔT=45°C   | h:min   | 1,22      | 2:12'     | 2:45'     | 2:12'    | 2:45'       | 2:27'       | 2:27'        | 3:03'        | 3:03' |       |     |      |     |      |       |       |        |        |     |
| Toplinski gubici kod 65°C | kWh/24h | 0,96      | 1,22      | 1,39      | 1,48     | 1,65        | 1,22        | 1,22         | 1,39         | 1,39  |       |     |      |     |      |       |       |        |        |     |
| Maks. radni tlak          | bar     | 8         | 8         | 8         | 8        | 8           | 8           | 8            | 8            | 8     |       |     |      |     |      |       |       |        |        |     |
| Maks. radna temperatura   | °C      | 75        | 75        | 75        | 75       | 75          | 75          | 75           | 75           | 75    |       |     |      |     |      |       |       |        |        |     |
| Težina                    | kg      | 16        | 21,5      | 25        | 21,5     | 25          | 24          | 24           | 28           | 28    |       |     |      |     |      |       |       |        |        |     |
| Klasa                     | IP      | IPX3/IPX4 | IPX3/IPX4 | IPX3/IPX4 | IPX1     | IPX1        | IPX3        | IPX3         | IPX3         | IPX3  |       |     |      |     |      |       |       |        |        |     |

|                                       |                                     |                                      |                          |                           |                              |                              |                               |                               |
|---------------------------------------|-------------------------------------|--------------------------------------|--------------------------|---------------------------|------------------------------|------------------------------|-------------------------------|-------------------------------|
| PRO R 50 V 2K<br>3200382<br>* 3200571 | PRO R 80 V 2K<br>3200383<br>3200572 | PRO R 100 V 2K<br>3200384<br>3200573 | PRO R 80 H 2K<br>3200475 | PRO R 100 H 2K<br>3200476 | PRO R 80 VTD 1,8K<br>3200401 | PRO R 80 VTS 1,8K<br>3200402 | PRO R 100 VTD 1,8K<br>3200403 | PRO R 100 VTS 1,8K<br>3200404 |
|---------------------------------------|-------------------------------------|--------------------------------------|--------------------------|---------------------------|------------------------------|------------------------------|-------------------------------|-------------------------------|

\* S IPX4 zaštitom i dodatnim sigurnosnim ventilom

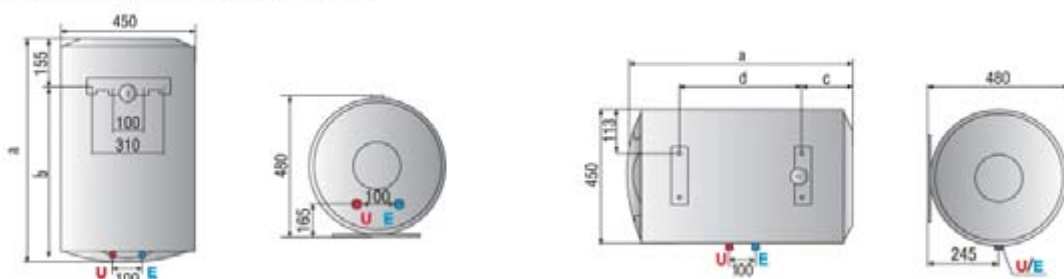

LEGENDA

**E** Ulaz hladne vode G 1/2"

**U** Izlaz tople vode G 1/2"

**T** Ulazne/izlazne termoelektrične cijevi G 3/4"



## PRO R mali



TBST

CE

Zidni električni bojler može se instalirati iznad ili ispod sudopera

- EMAJLIRAN UNUTARNJI SPREMNIK
- MAGNEZIJSKA ANODA
- VRLO PRECIZNA REGULACIJA
- TERMOSTAT VISOKE OSJETLJIVOSTI

| Š.Vokel | Opis                                                                       | Artikl  |
|---------|----------------------------------------------------------------------------|---------|
| 11567   | ELEKTRIČNI BOJLER ARISTON PRO R MALI 10OR R/3 NADPULTNI 10 Lit.            | 3100216 |
| 11582   | ELEKTRIČNI BOJLER ARISTON PRO R MALI 10UR R/3 PODPULTNI 10 Lit.            | 3100217 |
| 11583   | ELEKTRIČNI BOJLER ARISTON PRO R MALI 30 R/3 S VANJSKOM REGULACIJOM 30 Lit. | 3100220 |

Novi dizajn i kompaktne dimenzije. Ovi modeli mogu stati bilo gdje i osiguravaju toplu vodu odmah na slavini.



### Tehnički podaci - ukupne dimenzije

|                                 |         | PRO R     |           |           |           |        | PRO R |     |     |     |
|---------------------------------|---------|-----------|-----------|-----------|-----------|--------|-------|-----|-----|-----|
|                                 |         | 10 OR R/3 | 10 UR R/3 | 15 OR R/3 | 15 UR R/3 | 30 R/3 | 10    | 15  | 30  |     |
| Kapacitet                       | l       | 10        | 10        | 15        | 15        | 30     | a mm  | 360 | 360 | 446 |
| snaga                           | W       | 1200      | 1200      | 1200      | 1200      | 1500   | b mm  | 254 | 300 | 360 |
| napon                           | V       | 230       | 230       | 230       | 230       | 230    | c mm  | 360 | 360 | 446 |
| vrijeme zagrijavanja [ΔT= 45°C] | h, min. | 0,29      | 0,29      | 0,44      | 0,44      | 1,10   | d mm  | 92  | 78  | 115 |
| maks. temperatura zagrijavanja  | °C      | 80        | 80        | 80        | 80        | 80     | e mm  | 144 | 144 | 165 |
| Toplinski gubici                | kWh/24h | 0,43      | 0,55      | 0,53      | 0,65      | 0,61   |       |     |     |     |
| maks. radni tlak                | bar     | 8         | 8         | 8         | 8         | 8      |       |     |     |     |
| težina                          | kg      | 6,4       | 6,4       | 7,1       | 7,2       | 12     |       |     |     |     |
| zaštita                         | IP      | IPX1      | IPX1      | IPX1      | IPX1      | IPX1   |       |     |     |     |

OR= iznad sudopera  
UR= ispod sudopera

| 10 OR R/3 | 10 UR R/3 | 15 OR R/3 | 15 UR R/3 | 30 R/3  |
|-----------|-----------|-----------|-----------|---------|
| 3100216   | 3100217   | 3100218   | 3100219   | 3100220 |
| 3100250   | 3100251   | 3100252   | 3100253   | 3100254 |

\* S utikačem i kabelom [PL]

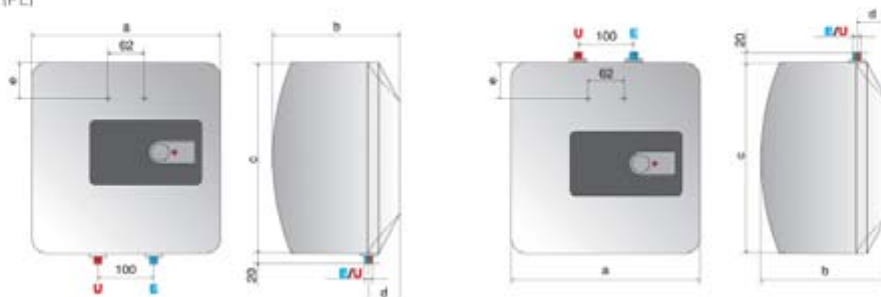

legenda

E ulaz hladne vode G 1/2"

U izlaz tople vode G 1/2"



# ANDRIS RS



### / NAJVEĆA UDOBNOST

Akumulacijske grijalice vode iz serije Andris mogu dugo čuvati toplinu zahvaljujući gustom i debelom poliuretanskom izolacijskom sloju koji se nalazi između spremnika i vanjskog dijela grijalice. Grijalice vode iz serije Andris imaju ugrađeni termostat, koji omogućuje precizno upravljanje temperaturom vode kako vi to želite.

### / DIZAJN

Zahvaljujući dugogodišnjoj suradnji s talijanskim dizajnerima, dizajn proizvoda iz serije Andris odlikuje se elegancijom i stilom svojstvenim za Aristonove proizvode.

### / POTPUNA SIGURNOST I HIGIJENA

Svi proizvodi iz serije Andris prošli su sva ispitivanja sigurnosti potrebna za postizanje potpune sukladnosti s CE direktivama. Grijajući element u bakru pomaže u održavanju higijene i čistoće vode koja se zagrijava u grijalici.

### / MALA VELIČINA

Zahvaljujući sustavu Mini-Tank (mini-spremnik), udobnost grijalice vode Ariston sadržana je u kompaktnom rješenju. Unatoč svojoj veličini, ova tri proizvoda mogu zagrijati do 30 litara vode.

### / IZDRŽLJIVOST

Tajna izdržljivosti proizvoda iz serije Andris jest odabir materijala: grijajući element izrađen je od bakra, zbog čega je otporan na koroziju. Unutarnji spremnik proizvoda Andris Lux Eco i Andris Lux ima posebnu presvlaku od titanija, što tim dvama elementima daje još veću izdržljivost i učinak protiv korozije. Jača struktura priružice ograničava rizik od curenja i smanjuje potrebu za održavanjem.

| Š.Vokel | Opis                                                     | Artikl  |
|---------|----------------------------------------------------------|---------|
| 0211072 | ELEKTRIČNI BOJLER ARISTON ANDRIS RS 10U/3 10 L Podpultni | 3100330 |
|         | ELEKTRIČNI BOJLER ARISTON ANDRIS RS 10/3 10 L Nadpultni  | 3100329 |
|         | ELEKTRIČNI BOJLER ARISTON ANDRIS RS 15U/3 15 L Podpultni | 3100335 |
|         | ELEKTRIČNI BOJLER ARISTON ANDRIS RS 15/3 15 L Nadpultni  | 3100334 |
|         | ELEKTRIČNI BOJLER ARISTON ANDRIS RS 30 Litara            | 3100339 |



| 10 | 15 | 15 | 30 |
|----|----|----|----|
|    |    |    |    |
|    |    |    |    |

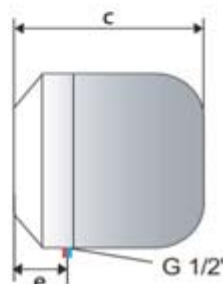
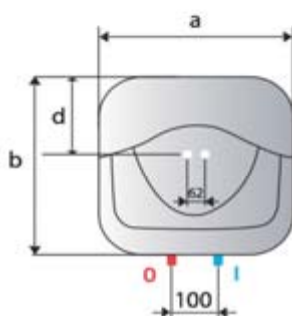

|      | AN 15 R 1.5 SIN<br>15 | AN 30 R 1.5 SIN<br>30 |
|------|-----------------------|-----------------------|
| a mm | 360                   | 447                   |
| b mm | 360                   | 447                   |
| c mm | 318                   | 380                   |
| d mm | 145                   | 160                   |
| e mm | 81                    | 115                   |

# ARKS



Zidni električni bojler može se instalirati iznad ili ispod sudopera

- VENTILIRANI SPREMNIK
- UNUTARNJI SPREMNIK IZNIMNO OTPORAN NA KOROZIJU
- SUSTAV ZA RESETIRANJE
- SIGURNOSNI SUSTAV ZA ZAŠTITU OD PREVIŠKE TEMPERATURE
- ANTI VAKUUM
- TERMOSTATSKA ZAŠTITA PROTIV VISOKE TEMPERATURE

| Š.Vokel | Opis                                               | Artikl |
|---------|----------------------------------------------------|--------|
| 11565   | ELEKTRIČNI BOJLER ARISTON ARKS 50 NADPULTNI 5 Lit. | 868871 |
| 11566   | ELEKTRIČNI BOJLER ARISTON ARKS 5U PODPULTNI 5 Lit. | 868872 |



Novi dizajn i kompaktne dimenzije. Ovi modeli mogu stati bilo gdje i osiguravaju toplu vodu odmah na slavini.

## Tehnički podaci - ukupne dimenzije

|                                 |         | ARKS 5 U | ARKSH 5 U | ARKS 5 O | ARKSH 5 O |      |     |     |     |     |
|---------------------------------|---------|----------|-----------|----------|-----------|------|-----|-----|-----|-----|
| Kapacitet                       | l       | 5        | 5         | 5        | 5         | a mm | 250 | 250 | 270 | 270 |
| Snaga                           | W       | 2000     | 2000      | 2000     | 2000      | b mm | 365 | 365 | 417 | 417 |
| Napon                           | V       | 230      | 230       | 230      | 230       | c mm | 184 | 184 | 195 | 195 |
| Vrijeme zagrijavanja (ΔT= 45°C) | h/m     | 9        | 9         | 9        | 9         | d mm | -   | -   | 304 | 304 |
| Maks. radna temperatura         | °C      | 75       | 75        | 75       | 75        |      |     |     |     |     |
| Toplinski gubici                | kWh/24h | 0,25     | 0,25      | 0,25     | 0,25      |      |     |     |     |     |
| Maksimalni radni tlak           | bar     | 0        | 0         | 0        | 0         |      |     |     |     |     |
| Masa                            | kg      | 3,3      | 3,3       | 3,3      | 3,3       |      |     |     |     |     |

|  | ARKS 5 U | ARKSH 5 U | ARKS 5 O | ARKSH 5 O |
|--|----------|-----------|----------|-----------|
|  | 868872   | 879009    | 868871   | 879008    |

\* S utikačem i kabelom (PL)

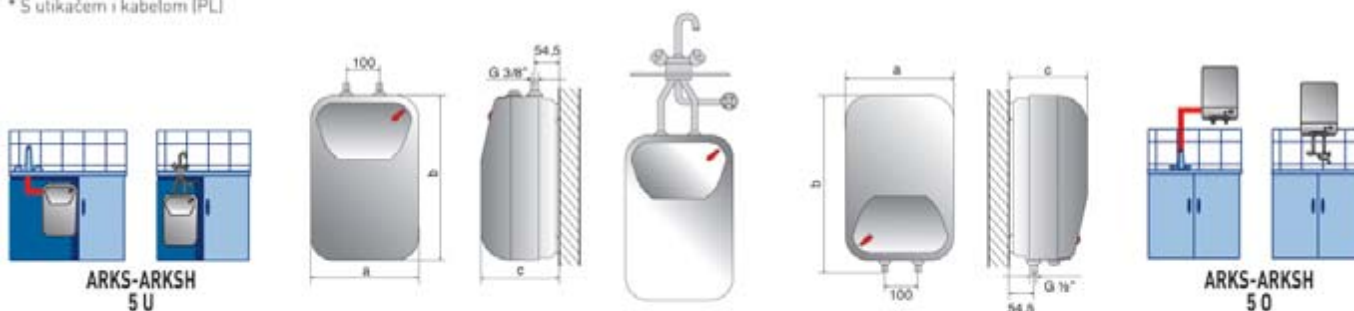

# ARI STAB



## Samostojeći električni bojler

- UNUTARNJI ČELIČNI SPREMNIK EMAJLIRAN TITANIJEM I TESTIRAN NA 12 BARA
- VRLO VELIKO REVIZIJSKO OKNO S 5 VIJAKA
- VELIKA MAGNEZIJSKA ANODA
- TERMOSTAT S BIPOLARNIM SIGURNOSNIM UREĐAJEM
- TLAČNI VENTIL TESTIRAN NA 7 BARA
- ISPORUČEN SA SIGURNOSNIM VENTILOM

| Š.Vokel | Opis                                                       | Artikl  |
|---------|------------------------------------------------------------|---------|
| 11642   | INDUSTRIJSKI ELEKTRIČNI BOJLER ARISTON PODNI STAB 200 Lit. | 3200298 |
| 11644   | INDUSTRIJSKI ELEKTRIČNI BOJLER ARISTON ARI STAB 300 Lit.   | 3200300 |
| 11652   | INDUSTRIJSKI ELEKTRIČNI BOJLER ARISTON TI STI 500 Lit.     | 828016  |

Maksimalna učinkovitost i sigurnost. Velika ponuda električnih bojlera za proizvodnju velikih količina tople vode u domaćinstvu kako bi se zadovoljile sve potrebe



### Tehnički podaci - ukupne dimenzije

|                                |         | ARI 200 STAB | ARI 250 STAB | ARI 300 STAB | TI STI 500 |              |              |              |            |      |
|--------------------------------|---------|--------------|--------------|--------------|------------|--------------|--------------|--------------|------------|------|
|                                |         | ARI 200 STAB | ARI 250 STAB | ARI 300 STAB | TI STI 500 | ARI 200 STAB | ARI 250 STAB | ARI 300 STAB | TI STI 500 |      |
| Kapacitet                      | l       | 200          | 250          | 300          | 500        | a mm         | 1320         | 1270         | 1800       | 1870 |
| Napajanje                      | W       | 3000         | 3000         | 3000         | 6000       | b mm         | 560          | 560          | 560        | 710  |
| Napon                          | V       | 230/400      | 230/400      | 230/400      | 230/400    | c mm         | 390          | 365          | 365        | 335  |
| Vrijeme zagrijavanja (ΔT=15°C) | h, min. | 4,76         | 5,00         | 5,54         | 4,40       | d mm         | -            | -            | -          | -    |
| Maks. radna temperatura        | °C      | 75           | 75           | 75           | 75         | e mm         | -            | -            | -          | -    |
| Toplinški gubici               | kWh/24h | 1,88         | 2,17         | 2,6          | 3,6        | f mm         | -            | -            | -          | -    |
| Maksimalni radni tlak          | bar     | 8            | 8            | 8            | 8          | g mm         | -            | -            | -          | -    |
| Zaštita                        | IP      | IP250        | IP250        | IP250        | IP250      |              |              |              |            |      |
| Težina                         | kg      | 50           | 61           | 71           | 95         |              |              |              |            |      |

ARI 200 STAB  
3200298

ARI 250 STAB  
3010139

ARI 300 STAB  
3200300

TI STI 500  
828016

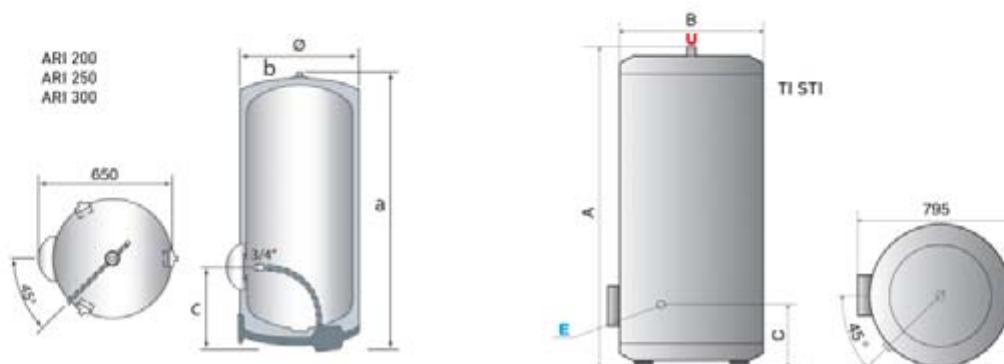

# TI TRONIC INDUSTRIAL



## Zidni električni bojler

- VELIKA KOLIČINA TOPLE VODE: DO 440 L NA 40°C KOD JEDNOG KORIŠTENJA
- UNUTARNJI SPREMNIK EMAJLIRAN TITANIJEM TESTIRAN NA 16 BARA
- VRLO VELIKO REVIZIJSKO OKNO S 5 VIJAKA
- VELIKA MAGNEZIJSKA ANODA
- REGULACIJA TEMPERATURE
- TERMOSTAT S BIPOLARNIM SIGURNOSNIM UREĐAJEM
- SIGURNOSNI VENTIL TESTIRAN NA 8 BARA
- GRIJAČ SA ZAŠTITOM OD NAKUPLJANJA KAMENCA
- ISPORUČEN SA SIGURNOSNIM VENTILOM (SAMO VERTIKALNI MODEL)



| Š.Vokel | Opis                                                                                             | Artikl |
|---------|--------------------------------------------------------------------------------------------------|--------|
|         | INDUSTRIJSKI ELEKTRIČNI BOJLER ARISTON TI TRONIC 120 TS/C 120 Lit. ZIDNI KOMBINIRANI SAMO LIJEVI | 006956 |
| 11653   | INDUSTRIJSKI ELEKTRIČNI BOJLER ARISTON TI TRONIC 150 TS/C 150 Lit. ZIDNI KOMBINIRANI LIJEVI      | 006957 |
| 11659   | INDUSTRIJSKI ELEKTRIČNI BOJLER ARISTON TI TRONIC 200 TS/C 200 Lit. ZIDNI KOMBINIRANI SAMO LIJEVI | 006958 |
| 11633   | INDUSTRIJSKI ELEKTRIČNI BOJLER ARISTON TI TRONIC TI 150 Lit. ZIDNI                               | 006951 |

## Tehnički podaci - ukupne dimenzije

|                                                    |         | TI TRONIC INDUSTRIAL |             |             |          |          |          |          |          |          |      |          |          |          |          |          |          |          |          |          |  |
|----------------------------------------------------|---------|----------------------|-------------|-------------|----------|----------|----------|----------|----------|----------|------|----------|----------|----------|----------|----------|----------|----------|----------|----------|--|
|                                                    |         | TI 120 TS/C          | TI 150 TS/C | TI 200 TS/C | TI 150 L | TI 150 C | TI 150 H | TI 200 L | TI 100 C | TI 200 H |      | 120 TS/C | 150 TS/C | 200 TS/C | TI 150 L | TI 150 C | TI 150 H | TI 200 L | TI 100 C | TI 200 H |  |
| Kapacitet                                          | l       | 120                  | 150         | 200         | 150      | 150      | 150      | 200      | 200      | 200      | a mm | 495      | 505      | 505      | 505      | 505      | 495      | 505      | 495      | 495      |  |
| Napajanje                                          | kW      | 2                    | 2,2         | 2,5         | 2,2      | 2,2      | 2,2      | 2,5      | 2,5      | 2,5      | b mm | 790      | 1058     | 1058     | 1058     | 1058     | 1209     | 1058     | 1535     | 1535     |  |
| Napon                                              | V       | 230                  | 230         | 230         | 230      | 230      | 230      | 230      | 230      | 230      | c mm | 100      | 230      | 230      | 230      | 230      | -        | 230      | -        | -        |  |
| Vrijeme zagrijavanja [delta T=45°C]                | h,min   | 3,18                 | 3,45        | 4,24        | 3,57     | 3,57     | 3,57     | 4,28     | 4,28     | 4,28     | d mm | 108      | 178      | 178      | 178      | 178      | -        | 178      | -        | -        |  |
| Maks. radna temperatura                            | °C      | 75                   | 75          | 75          | 75       | 75       | 75       | 75       | 75       | 75       | e mm | 180      | 98       | 420      | 98       | 98       | -        | 420      | -        | -        |  |
| Toplinski gubici                                   | kWh/24h | 1,4                  | 1,6         | 2,1         | 1,65     | 1,65     | 2,09     | 1,91     | 1,91     | 2,61     | f mm | 255      | 260      | 260      | -        | -        | 500      | -        | 500      |          |  |
| Maks. radni tlak                                   |         | 8                    | 8           | 8           | 8        | 8        | 8        | 8        | 8        | 8        | g mm | 208      | 217      | 217      | -        | -        | 536      | -        | 536      |          |  |
| Težina                                             | kg      | 45                   | 52,4        | 64,1        | 41       | 41       | 41       | 51       | 51       | 51       | h mm | 477      | 477      | 477      | -        | -        | -        | -        | -        |          |  |
| Debljina unutarnjeg čeličnog spremnika [prosječna] | mm      | -                    | -           | -           | 1,7      | 1,7      | 1,7      | 1,7      | 1,7      | 1,7      |      |          |          |          |          |          |          |          |          |          |  |
| Debljina izolacije [prosječna]                     | mm      | -                    | -           | -           | 30       | 30       | 30       | 30       | 30       | 30       |      |          |          |          |          |          |          |          |          |          |  |

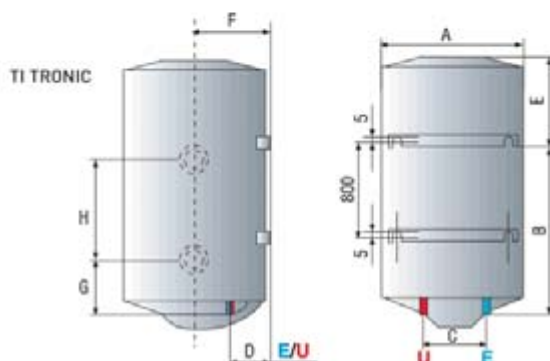

### LEGENDA

- E** Ulaz hladne vode G 3/4"
- U** Izlaz tople vode G 3/4"







|                                                                                     |                                                                 |
|-------------------------------------------------------------------------------------|-----------------------------------------------------------------|
|    | <b>1157001</b> SUŠILO ZA RUKE WINDY ABS 1900 ART.K2201A         |
|                                                                                     | <b>1157012</b> SUŠILO ZA RUKE WINDY ABS 2050 ART.K2201A-2       |
|    | <b>1157002</b> SUŠILO ZA RUKE WINDY INOX 1650 ART.K7A           |
|                                                                                     | <b>1157013</b> SUŠILO ZA RUKE WINDY INOX 2050 ART.K7A-2         |
|   | <b>1157003</b> SUŠILO ZA RUKE WINDY INOX SENSOR 2300 ART.K2502A |
|  | <b>1157004</b> SUŠILO ZA RUKE WINDY INOX PUSH 2300 ART.K2502A-K |
|  | <b>1157005</b> SUŠILO ZA RUKE WINDY ABS 1500 ART.K1005E         |
|  | <b>1157006</b> SUŠILO ZA KOSU WINDY ABS SOCKET 1200 ART.K3513A  |
|  | <b>1157007</b> SUŠILO ZA KOSU WINDY ABS 1200 ART.K3515          |



|                                                                                     |                |                                                                                                                       |
|-------------------------------------------------------------------------------------|----------------|-----------------------------------------------------------------------------------------------------------------------|
|    | <b>1157008</b> | SUŠILO ZA RUKE WINDY INOX 2300                                                                                        |
|   | <b>1157009</b> | UGRADNI DRŽAČ PAPIRNATIH RUČNIKA INOX<br>S KUTIJOM ZA OTPATKE I MOGUĆNOŠĆU UGRADNJE<br>SUŠILA ZA RUKE 370x160x1650 mm |
|  | <b>1157010</b> | NADGRADNI DRŽAČ PAPIRNATIH RUČNIKA INOX<br>S KUTIJOM ZA OTPATKE 325x150x750 mm                                        |
|  | <b>1157011</b> | UGRADNI DRŽAČ PAPIRNATIH RUČNIKA INOX<br>S KUTIJOM ZA OTPATKE 325x150x750 mm                                          |

| <table border="1"> <thead> <tr> <th></th> <th>A</th> <th>B</th> <th>C</th> <th>D</th> <th>∅ E</th> </tr> </thead> <tbody> <tr> <td>M 100/4"</td> <td>159</td> <td>160</td> <td>100</td> <td>47</td> <td>89</td> </tr> <tr> <td>M 120/5"</td> <td>179</td> <td>181</td> <td>110</td> <td>47</td> <td>110</td> </tr> <tr> <td>M 150/6"</td> <td>214</td> <td>215</td> <td>117</td> <td>47</td> <td>158</td> </tr> </tbody> </table> |                                                                                                                                                                                                                                                                                                                                                                                                                                                             | A   | B   | C       | D        | ∅ E           | M 100/4"      | 159      | 160 | 100 | 47 | 89      | M 120/5" | 179      | 181 | 110 | 47 | 110     | M 150/6" | 214      | 215 | 117 | 47 | 158     | <b>51001</b> VENTILATOR M 100/4" LL ART.11202<br><b>51009</b> VENTILATOR M 120/5" LL ART.11302<br><b>51011</b> VENTILATOR M 150/6" LL ART.11402 |                                                                     |
|-----------------------------------------------------------------------------------------------------------------------------------------------------------------------------------------------------------------------------------------------------------------------------------------------------------------------------------------------------------------------------------------------------------------------------------|-------------------------------------------------------------------------------------------------------------------------------------------------------------------------------------------------------------------------------------------------------------------------------------------------------------------------------------------------------------------------------------------------------------------------------------------------------------|-----|-----|---------|----------|---------------|---------------|----------|-----|-----|----|---------|----------|----------|-----|-----|----|---------|----------|----------|-----|-----|----|---------|-------------------------------------------------------------------------------------------------------------------------------------------------|---------------------------------------------------------------------|
|                                                                                                                                                                                                                                                                                                                                                                                                                                   |                                                                                                                                                                                                                                                                                                                                                                                                                                                             | A   | B   | C       | D        | ∅ E           |               |          |     |     |    |         |          |          |     |     |    |         |          |          |     |     |    |         |                                                                                                                                                 |                                                                     |
|                                                                                                                                                                                                                                                                                                                                                                                                                                   | M 100/4"                                                                                                                                                                                                                                                                                                                                                                                                                                                    | 159 | 160 | 100     | 47       | 89            |               |          |     |     |    |         |          |          |     |     |    |         |          |          |     |     |    |         |                                                                                                                                                 |                                                                     |
|                                                                                                                                                                                                                                                                                                                                                                                                                                   | M 120/5"                                                                                                                                                                                                                                                                                                                                                                                                                                                    | 179 | 181 | 110     | 47       | 110           |               |          |     |     |    |         |          |          |     |     |    |         |          |          |     |     |    |         |                                                                                                                                                 |                                                                     |
|                                                                                                                                                                                                                                                                                                                                                                                                                                   | M 150/6"                                                                                                                                                                                                                                                                                                                                                                                                                                                    | 214 | 215 | 117     | 47       | 158           |               |          |     |     |    |         |          |          |     |     |    |         |          |          |     |     |    |         |                                                                                                                                                 |                                                                     |
|                                                                                                                                                                                                                                                                                                                                                                                                                                   | <b>51002</b> VENTILATOR S TIMEROM M 100/4" T LL ART.11212<br><b>51010</b> VENTILATOR S TIMEROM M 120/5" T LL ART.11312<br><b>51012</b> VENTILATOR S TIMEROM M 150/6" T LL ART.11412                                                                                                                                                                                                                                                                         |     |     |         |          |               |               |          |     |     |    |         |          |          |     |     |    |         |          |          |     |     |    |         |                                                                                                                                                 |                                                                     |
|                                                                                                                                                                                                                                                                                                                                                                                                                                   | <b>51003</b> VENTILATOR AUTOMATSKI M 100/4" A LL ART.11222<br><b>51025</b> VENTILATOR AUTOMATSKI M 120/5" A LL ART.11322<br><b>51026</b> VENTILATOR AUTOMATSKI M 150/6" A LL ART.11422                                                                                                                                                                                                                                                                      |     |     |         |          |               |               |          |     |     |    |         |          |          |     |     |    |         |          |          |     |     |    |         |                                                                                                                                                 |                                                                     |
|                                                                                                                                                                                                                                                                                                                                                                                                                                   | <b>51005</b> VENTILATOR AUTOMATSKI S TIMEROM M 100/4" AT LL ART.11232<br><b>51027</b> VENTILATOR AUTOMATSKI S TIMEROM M 120/5" AT LL ART.11332<br><b>51028</b> VENTILATOR AUTOMATSKI S TIMEROM M 150/6" AT LL ART.11432                                                                                                                                                                                                                                     |     |     |         |          |               |               |          |     |     |    |         |          |          |     |     |    |         |          |          |     |     |    |         |                                                                                                                                                 |                                                                     |
|                                                                                                                                                                                                                                                                                                                                                                                                                                   | <b>51006</b> VENTILATOR ZA UGRADNJU U STAKLO F 110/4" A ART.11255<br><b>0215032</b> VENTILATOR ZA UGRADNJU U STAKLO F 120/5" A ART.11321                                                                                                                                                                                                                                                                                                                    |     |     |         |          |               |               |          |     |     |    |         |          |          |     |     |    |         |          |          |     |     |    |         |                                                                                                                                                 |                                                                     |
|                                                                                                                                                                                                                                                                                                                                                                                                                                   | <table border="1"> <thead> <tr> <th></th> <th>∅ A</th> <th>B</th> <th>C</th> <th>∅ STAKLA</th> <th>MAX. DEBLJINA</th> </tr> </thead> <tbody> <tr> <td>F 100/4"</td> <td>158</td> <td>69</td> <td>22</td> <td>123+128</td> <td>20</td> </tr> <tr> <td>F 120/5"</td> <td>179</td> <td>80</td> <td>33</td> <td>143+148</td> <td>20</td> </tr> <tr> <td>F 150/6"</td> <td>213</td> <td>87</td> <td>40</td> <td>178+183</td> <td>20</td> </tr> </tbody> </table> |     | ∅ A | B       | C        | ∅ STAKLA      | MAX. DEBLJINA | F 100/4" | 158 | 69  | 22 | 123+128 | 20       | F 120/5" | 179 | 80  | 33 | 143+148 | 20       | F 150/6" | 213 | 87  | 40 | 178+183 | 20                                                                                                                                              | <b>51035</b> DODATAK ZA UGRAĐIVANJE VENTILATORA NA STAKLO ART.22131 |
|                                                                                                                                                                                                                                                                                                                                                                                                                                   |                                                                                                                                                                                                                                                                                                                                                                                                                                                             | ∅ A | B   | C       | ∅ STAKLA | MAX. DEBLJINA |               |          |     |     |    |         |          |          |     |     |    |         |          |          |     |     |    |         |                                                                                                                                                 |                                                                     |
|                                                                                                                                                                                                                                                                                                                                                                                                                                   | F 100/4"                                                                                                                                                                                                                                                                                                                                                                                                                                                    | 158 | 69  | 22      | 123+128  | 20            |               |          |     |     |    |         |          |          |     |     |    |         |          |          |     |     |    |         |                                                                                                                                                 |                                                                     |
| F 120/5"                                                                                                                                                                                                                                                                                                                                                                                                                          | 179                                                                                                                                                                                                                                                                                                                                                                                                                                                         | 80  | 33  | 143+148 | 20       |               |               |          |     |     |    |         |          |          |     |     |    |         |          |          |     |     |    |         |                                                                                                                                                 |                                                                     |
| F 150/6"                                                                                                                                                                                                                                                                                                                                                                                                                          | 213                                                                                                                                                                                                                                                                                                                                                                                                                                                         | 87  | 40  | 178+183 | 20       |               |               |          |     |     |    |         |          |          |     |     |    |         |          |          |     |     |    |         |                                                                                                                                                 |                                                                     |
|                                                                                                                                                                                                                                                                                                                                                                                                                                   | <b>51013</b> VENTILATOR VORT MICRO Ø 100 ART.11900                                                                                                                                                                                                                                                                                                                                                                                                          |     |     |         |          |               |               |          |     |     |    |         |          |          |     |     |    |         |          |          |     |     |    |         |                                                                                                                                                 |                                                                     |
|                                                                                                                                                                                                                                                                                                                                                                                                                                   | <b>51014</b> VENTILATOR S TIMEROM VORT MICRO S 100 ART.11910                                                                                                                                                                                                                                                                                                                                                                                                |     |     |         |          |               |               |          |     |     |    |         |          |          |     |     |    |         |          |          |     |     |    |         |                                                                                                                                                 |                                                                     |
|                                                                                                                                                                                                                                                                                                                                                                                                                                   | <b>51019</b> VENTILATOR CENTRIFUG. CA 100-VO ART.16008                                                                                                                                                                                                                                                                                                                                                                                                      |     |     |         |          |               |               |          |     |     |    |         |          |          |     |     |    |         |          |          |     |     |    |         |                                                                                                                                                 |                                                                     |

|                                                                                     |              |                                   |       |            |
|-------------------------------------------------------------------------------------|--------------|-----------------------------------|-------|------------|
|    | <b>51030</b> | VENTILATOR DEMING 2001            | Ø 100 | ART.7010   |
|                                                                                     | <b>51031</b> | VENTILATOR DEMING 2001            | Ø 120 | ART.7020   |
|                                                                                     | <b>51037</b> | VENTILATOR DEMING 2001/PP         | Ø 100 | ART.7011   |
|                                                                                     | <b>51038</b> | VENTILATOR DEMING 2001/PP         | Ø 120 | ART.7021   |
|                                                                                     | <b>51036</b> | VENTILATOR DEMING 2001/TIMER      | Ø 100 | ART.7015   |
|                                                                                     | <b>12043</b> | VENTILATOR DEMING 2001/TIMER      | Ø 120 | ART.7025   |
|    | <b>12237</b> | MASKA ZA VENTILACIJU FIKSNA TF10  |       |            |
|                                                                                     | <b>12238</b> | MASKA ZA VENTILACIJU FIKSNA TF12  |       |            |
|    | <b>12239</b> | MASKA ZA VENTILACIJU VANJSKA TG10 |       |            |
|                                                                                     | <b>12240</b> | MASKA ZA VENTILACIJU VANJSKA TG12 |       |            |
|   | <b>11204</b> | VENTILACIJSKA REŠETKA Ø 120       |       | ART.032527 |
|                                                                                     | <b>11205</b> | VENTILACIJSKA REŠETKA Ø 150       |       | ART.753387 |
|  | <b>11206</b> | VENTILAC. REŠETKA S DRŽAČEM Ø135  |       | ART.001956 |
|                                                                                     | <b>11352</b> | VENTILAC. REŠETKA S DRŽAČEM Ø175  |       | ART.001958 |
|                                                                                     | <b>11207</b> | VENTILAC. REŠETKA S DRŽAČEM Ø 235 |       | ART.001960 |
|  | <b>11210</b> | VENTILAC. REŠETKA INOX 140 x 140  |       | ART.753394 |
|  | <b>11209</b> | VENTILACIJSKA REŠETKA 175 x 146   |       | ART.001966 |
|  | <b>11208</b> | VENTILACIJSKA REŠETKA 370 x 130   |       | ART.753386 |

|                                                                                     |                                                                                                              |                                                                                                                                                                                                                                                                                                                                                            |
|-------------------------------------------------------------------------------------|--------------------------------------------------------------------------------------------------------------|------------------------------------------------------------------------------------------------------------------------------------------------------------------------------------------------------------------------------------------------------------------------------------------------------------------------------------------------------------|
|    | <b>12707</b>                                                                                                 | VRATA ZA KADU UNIVERZALNA MAGNETNA                                                                                                                                                                                                                                                                                                                         |
|    | <b>12009</b><br><b>12010</b><br><b>09089</b><br><b>12011</b><br><b>37021</b>                                 | VRATAŠCA ZA KADU OD NEHRĐAJUĆEG ČELIKA 15 x 15 cm<br>VRATAŠCA ZA KADU OD NEHRĐAJUĆEG ČELIKA 20 x 20 cm<br>VRATAŠCA ZA KADU OD NEHRĐAJUĆEG ČELIKA 20 x 25 cm<br>VRATAŠCA ZA KADU OD NEHRĐAJUĆEG ČELIKA 25 x 25 cm<br>VRATAŠCA ZA KADU OD NEHRĐAJUĆEG ČELIKA 30 x 30 cm                                                                                      |
|    | <b>90202</b><br><br><b>90203</b>                                                                             | VENTILACIJSKA ROZETA OD NEHRĐAJUĆEG ČELIKA 150x150 ANKO<br><br>VENTILACIJSKA ROZETA OD NEHRĐAJUĆEG ČELIKA 110x122 ANKO                                                                                                                                                                                                                                     |
|   | <b>90198</b><br><br><b>0306013</b><br><br><b>90199</b>                                                       | DIMNA ROZETA Ø 118 mm POCINČANA ANKO<br><br>DIMNA ROZETA Ø 118 mm BIJELA ANKO<br><br>VENTILACIJSKA ROZETA Ø 118 mm POCINČANA ANKO                                                                                                                                                                                                                          |
|  | <b>90200</b><br><br><b>0306015</b><br><br><b>90201</b><br><br><b>0306016</b>                                 | VRATAŠCA ZA DIMNJAK MALA POCINČANA ANKO<br><br>VRATAŠCA ZA DIMNJAK 120x180 MALA BIJELA ANKO<br><br>VRATAŠCA ZA ŠIDEL DIMNJAK 160x280 POCINČANA ANKO<br><br>VRATAŠCA ZA ŠIDEL DIMNJAK 160x280 BIJELA ANKO                                                                                                                                                   |
|  | <b>0223001</b>                                                                                               | GRIJALICA INSTANT 1800 W, 3 INFRA GRIJAČA I VENTILATOR                                                                                                                                                                                                                                                                                                     |
|  | <b>11727</b><br><b>11728</b><br><b>42078</b><br><b>11729</b><br><b>12423</b><br><b>11730</b><br><b>42099</b> | CIJEV FLEKSIBILNA ALUMINIJSKA Ø 110 ART.720580<br>CIJEV FLEKSIBILNA ALUMINIJSKA Ø 120 ART.720581<br>CIJEV FLEKSIBILNA ALUMINIJSKA Ø 130 ART.720582<br>CIJEV FLEKSIBILNA ALUMINIJSKA Ø 140 ART.720588<br>CIJEV FLEKSIBILNA ALUMINIJSKA Ø 150 ART.720594<br>CIJEV FLEKSIBILNA ALUMINIJSKA Ø 160 ART.720596<br>CIJEV FLEKSIBILNA ALUMINIJSKA Ø 180 ART.720597 |

|                                                                                     |                |                                                 |         |           |                  |
|-------------------------------------------------------------------------------------|----------------|-------------------------------------------------|---------|-----------|------------------|
|    | <b>0225023</b> | VENTILACIJSKA REŠETKA S ZAKAČKOM BIJELA CO VENT | 166x166 | Ø 80/125  | ART.9602-006-06  |
|                                                                                     | <b>0225024</b> | VENTILACIJSKA REŠETKA S ZAKAČKOM BIJELA CO VENT | 190x190 | Ø 125/160 | ART.9601-006-06  |
|                                                                                     | <b>0225025</b> | VENTILACIJSKA REŠETKA S ZAKAČKOM BIJELA CO VENT | 238x238 | Ø 160/200 | ART.9600-006-06  |
|    | <b>0225028</b> | VENTILACIJSKA REŠETKA S ZAKAČKOM BIJELA EKO AIR | Ø 140   |           | ART.9501-006-01  |
|                                                                                     | <b>0225029</b> | VENTILACIJSKA REŠETKA S ZAKAČKOM BIJELA EKO AIR | Ø 175   |           | ART.9502-006-01  |
|                                                                                     | <b>0225030</b> | VENTILACIJSKA REŠETKA S ZAKAČKOM BIJELA EKO AIR | Ø 220   |           | ART.9503-006-01  |
|   | <b>0225061</b> | VENTILACIJSKA REŠETKA INOX CO VENT              | Ø 130   |           | ART.9699-806-400 |
|  | <b>0225062</b> | VENTILACIJSKA REŠETKA BOJA BAKRA CO VENT        | Ø 130   |           | ART.9699-806-500 |
|  | <b>0225065</b> | VENTILACIJSKA REŠETKA INOX CO VENT              | 150x150 |           | ART.9696-806-400 |
|  | <b>0225066</b> | VENTILACIJSKA REŠETKA BOJA BAKRA CO VENT        | 150x150 |           | ART.9696-806-500 |



|                                                                                     |                |                                                      |           |                  |
|-------------------------------------------------------------------------------------|----------------|------------------------------------------------------|-----------|------------------|
|    | <b>0225077</b> | VENTILACIJSKA REŠETKA<br>BIJELA                      | 150x150   | ART.9751-070-01  |
|    | <b>0225053</b> | VENTILACIJSKA REŠETKA S<br>MREŽICOM BIJELA CO VENT   | 230x430   | ART.9621-004-06  |
|                                                                                     | <b>0225054</b> | VENTILACIJSKA REŠETKA S<br>MREŽICOM BIJELA CO VENT   | 230x620   | ART.9622-004-06  |
|    | <b>0225031</b> | VENTILACIJSKA REŠETKA<br>BIJELA EKO AIR              | 150x200   | ART.9505-004-01  |
|                                                                                     | <b>0225032</b> | VENTILACIJSKA REŠETKA<br>BIJELA EKO AIR              | 230x230   | ART.9506-004-01  |
|                                                                                     | <b>0225033</b> | VENTILACIJSKA REŠETKA<br>BIJELA EKO AIR              | 230x430   | ART.9507-004-01  |
|   | <b>0225034</b> | VENTILACIJSKA REŠETKA<br>BIJELA EKO AIR              | Ø 100     | ART.9522-004-01  |
|                                                                                     | <b>0225035</b> | VENTILACIJSKA REŠETKA<br>BIJELA EKO AIR              | Ø 125     | ART.9523-004-01  |
|                                                                                     | <b>0225036</b> | VENTILACIJSKA REŠETKA<br>BIJELA EKO AIR              | Ø 160     | ART.9524-004-01  |
|  | <b>0225067</b> | VENTILACIJSKA REŠETKA<br>BIJELA ABS CO VENT          | Ø 100     | ART.9751-060-01  |
|  | <b>0225059</b> | VENTILACIJSKA REGULACIJSKA<br>REŠETKA BIJELA CO VENT | Ø 100     | ART.9750-061-01  |
|  | <b>0225060</b> | VENTILACIJSKA REŠETKA<br>BIJELA CO VENT              | Ø 100-150 | ART.9750-079-01  |
|  | <b>0225064</b> | VENTILACIJSKA REŠETKA<br>ALUMINIJSKA CO VENT         | Ø 100     | ART.9701-004-600 |
|  | <b>0225063</b> | VENTILACIJSKA REŠETKA<br>BOJA BAKRA CO VENT          | Ø 100     | ART.9701-004-500 |

|                                                                                     |                |                                                                                   |               |                  |
|-------------------------------------------------------------------------------------|----------------|-----------------------------------------------------------------------------------|---------------|------------------|
|    | <b>0225070</b> | VENTILACIJSKA REŠETKA<br>BIJELA ABS CO VENT                                       | 175x175 Ø 125 | ART.9751-071-01  |
|                                                                                     | <b>0225069</b> | VENTILACIJSKA REŠETKA<br>BIJELA ABS CO VENT                                       | 200x200 Ø 150 | ART.9751-072-01  |
|    | <b>0225037</b> | VENTILACIJSKA REŠETKA<br>INOX CO VENT                                             | 140x140       | ART.9691-804-400 |
|                                                                                     | <b>0225038</b> | VENTILACIJSKA REŠETKA<br>INOX CO VENT                                             | 230x230       | ART.9693-804-400 |
|   | <b>0225039</b> | VENTILATOR AIR FAN<br>19W 100 m <sup>3</sup> /h                                   | Ø 100         | ART.9799-140     |
|                                                                                     | <b>0225045</b> | VENTILATOR S TAJMEROM<br>AIR FAN 19W 100 m <sup>3</sup> /h                        | Ø 100         | ART.9799-141     |
|                                                                                     | <b>0225040</b> | VENTILATOR<br>AIR FAN 20W 150 m <sup>3</sup> /h                                   | Ø 120         | ART.9799-142X    |
|                                                                                     | <b>0225046</b> | VENTILATOR AIR FAN<br>25W 280 m <sup>3</sup> /h                                   | Ø 150         | ART.9799-143X    |
|  | <b>0225047</b> | VENTILATOR STANDARD AIR FAN<br>19W 100 m <sup>3</sup> /h                          | Ø 100         | ART.9799-151     |
|                                                                                     | <b>0225048</b> | VENTILATOR STANDARD<br>S TAJMEROM AIR FAN<br>19W 100 m <sup>3</sup> /h            | Ø 100         | ART.9799-153     |
|                                                                                     | <b>0225049</b> | VENTILATOR STANDARD<br>S TAJMEROM I SENZOROM<br>AIR FAN 19W 100 m <sup>3</sup> /h | Ø 100         | ART.9799-155     |
|  | <b>0225043</b> | VENTILATOR UGRADNI AIR FAN<br>20W 130 m <sup>3</sup> /h                           | Ø 100/120     | ART.9799-111     |
|  | <b>0225044</b> | VENTILATOR ZA NAPU AIR FAN<br>30W 110 m <sup>3</sup> /h                           | Ø 100/120     | ART.9799-115     |

|                                                                                     |                |                                                             |               |                  |
|-------------------------------------------------------------------------------------|----------------|-------------------------------------------------------------|---------------|------------------|
|    | <b>0225090</b> | VENTILATOR STAKLENI STANDARD                                | Ø 100         | ART.9799-160-700 |
|    | <b>0225074</b> | VENTILACIJSKA REŠETKA BIJELA SA ZATVARAČEM                  | 160x160       | ART.9750-031-01  |
|                                                                                     | <b>0225075</b> | VENTILACIJSKA REŠETKA BIJELA SA ZATVARAČEM                  | 200x200       | ART.9750-032-01  |
|                                                                                     | <b>0225076</b> | VENTILACIJSKA REŠETKA BIJELA SA ZATVARAČEM                  | 200x250       | ART.9750-033-01  |
|   | <b>0225082</b> | VENTILACIJSKA REŠETKA ABS OPEN-CLOSE BIJELA                 | 150x150 Ø 100 | ART.9751-040-01  |
|  | <b>0225083</b> | VENTILACIJSKA REŠETKA ABS AUTOMATSKA BIJELA                 | 150x150       | ART.9751-080-01  |
|                                                                                     | <b>0225084</b> | VENTILACIJSKA REŠETKA ABS AUTOMATSKA BIJELA                 | 190x190       | ART.9751-081-01  |
|  | <b>0225085</b> | ALUMINIJSKA VENTILACIJSKA REŠETKA DUPLA REGULACIJA BIJELA   | 180x180       | ART.9722-003-607 |
|                                                                                     | <b>0225086</b> | ALUMINIJSKA VENTILACIJSKA REŠETKA DUPLA REGULACIJA SREBRENA | 180x180       | ART.9722-003-641 |
|  | <b>0225087</b> | ADAPTER ZA ALUMINIJSKU VENTILACIJSKU REŠETKU                | 180x180 Ø 120 | ART.9722-049-100 |

|                                                                                    |                |                                             |           |                 |
|------------------------------------------------------------------------------------|----------------|---------------------------------------------|-----------|-----------------|
|   | <b>0225088</b> | OZRAČNA VENTILACIJSKA<br>REŠETKA ABS BIJELA | 55x110    | ART.6002-200-08 |
|   | <b>0225089</b> | OZRAČNA VENTILACIJSKA<br>REŠETKA ABS BIJELA | 55x220    | ART.6001-200-08 |
|   | <b>0225072</b> | ALUMINIJSKA TRAKA<br>50x0,3                 | Kolut=50m | ART.9898-400    |
|  | <b>0225073</b> | ALUMINIJSKA TRAKA<br>S MREŽOM 50x0,3        | Kolut=50m | ART.9898-401    |

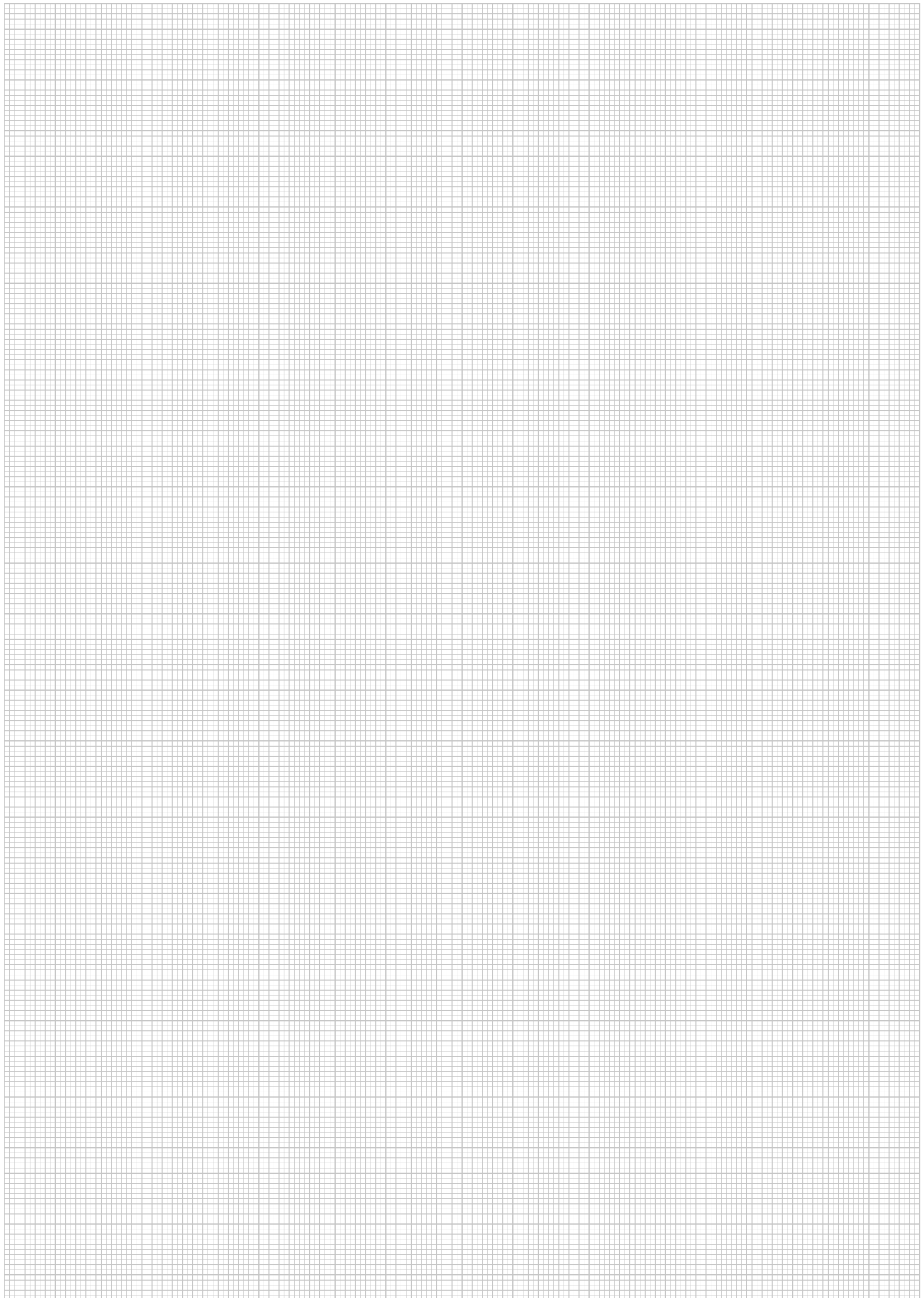



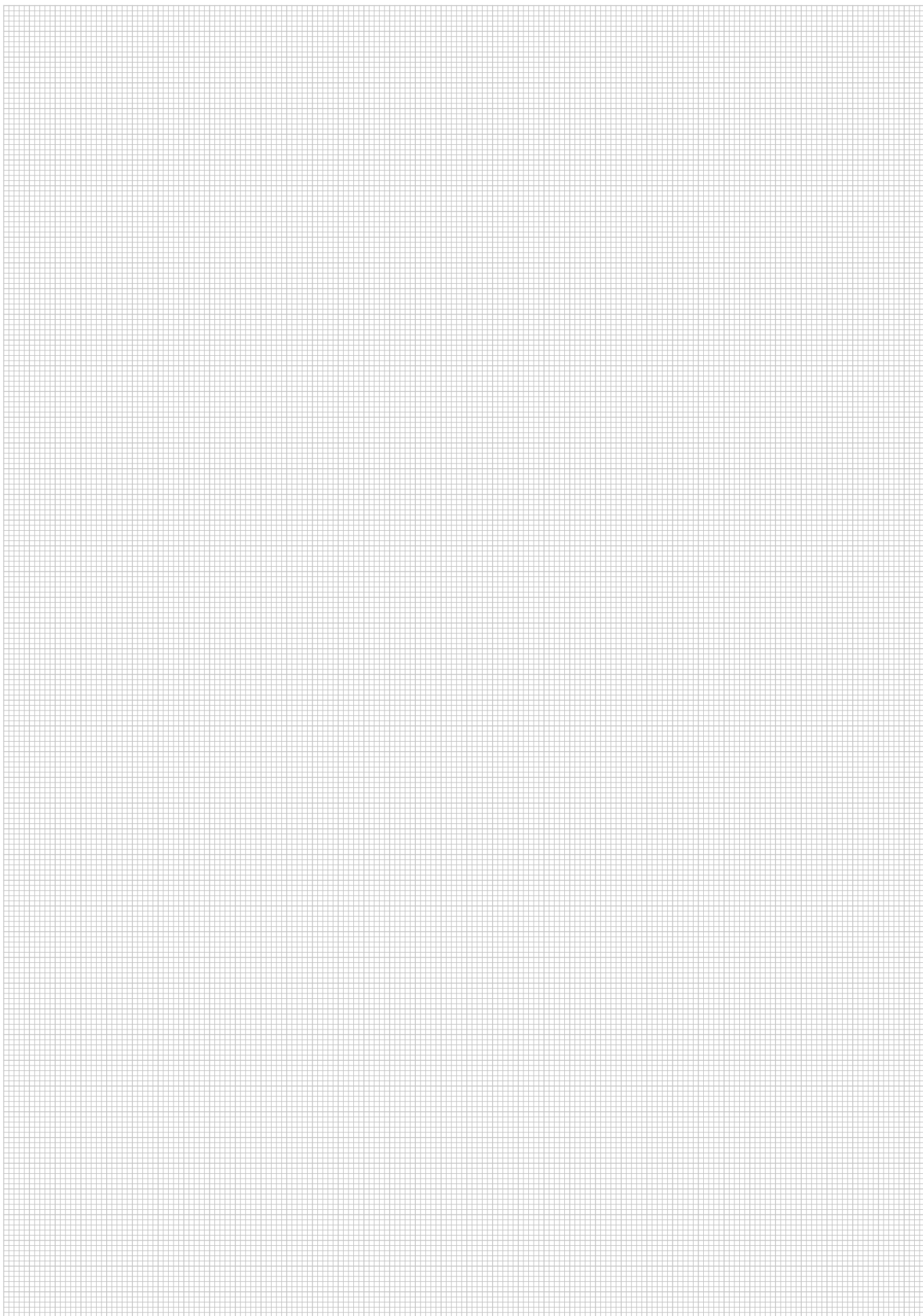

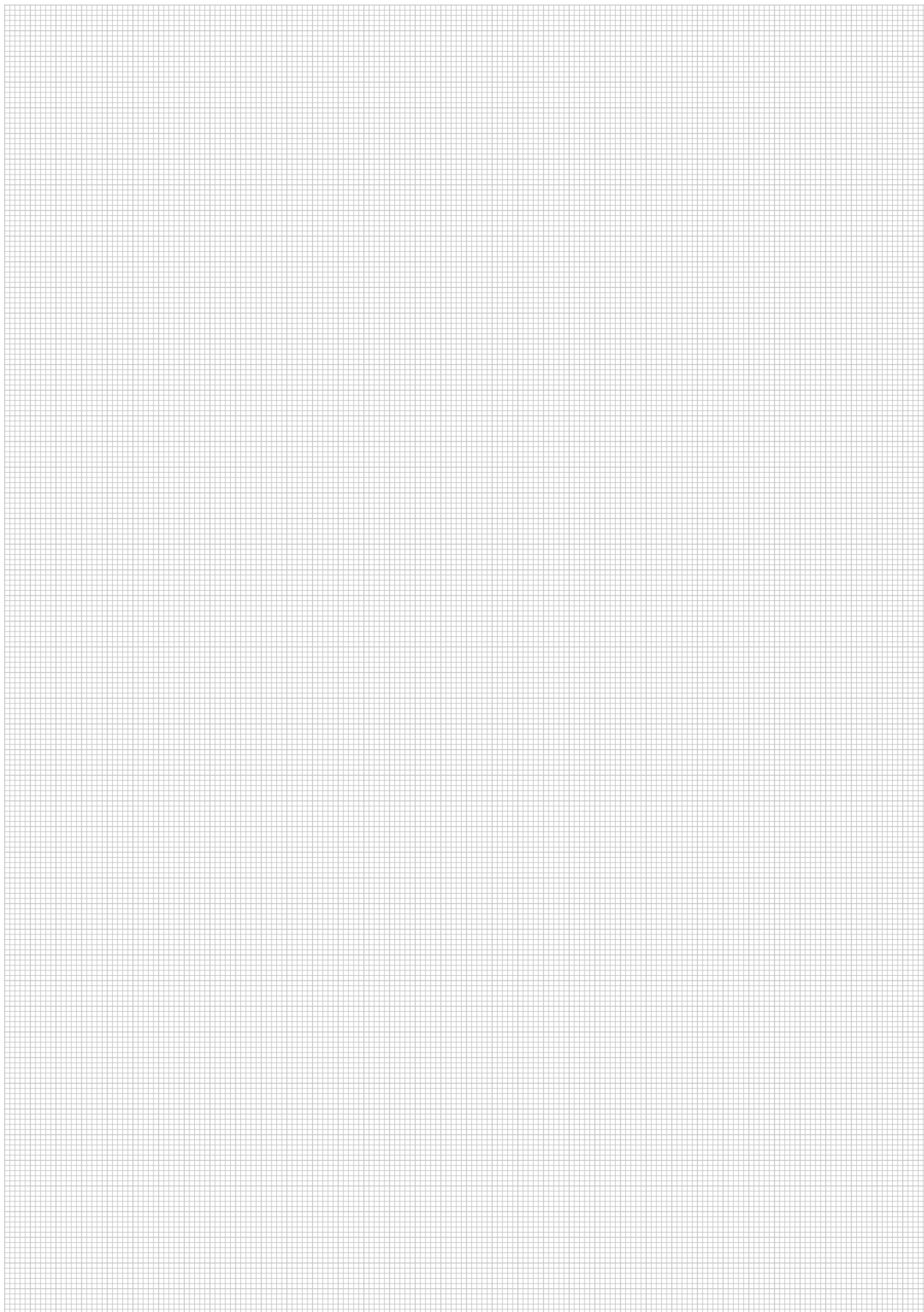

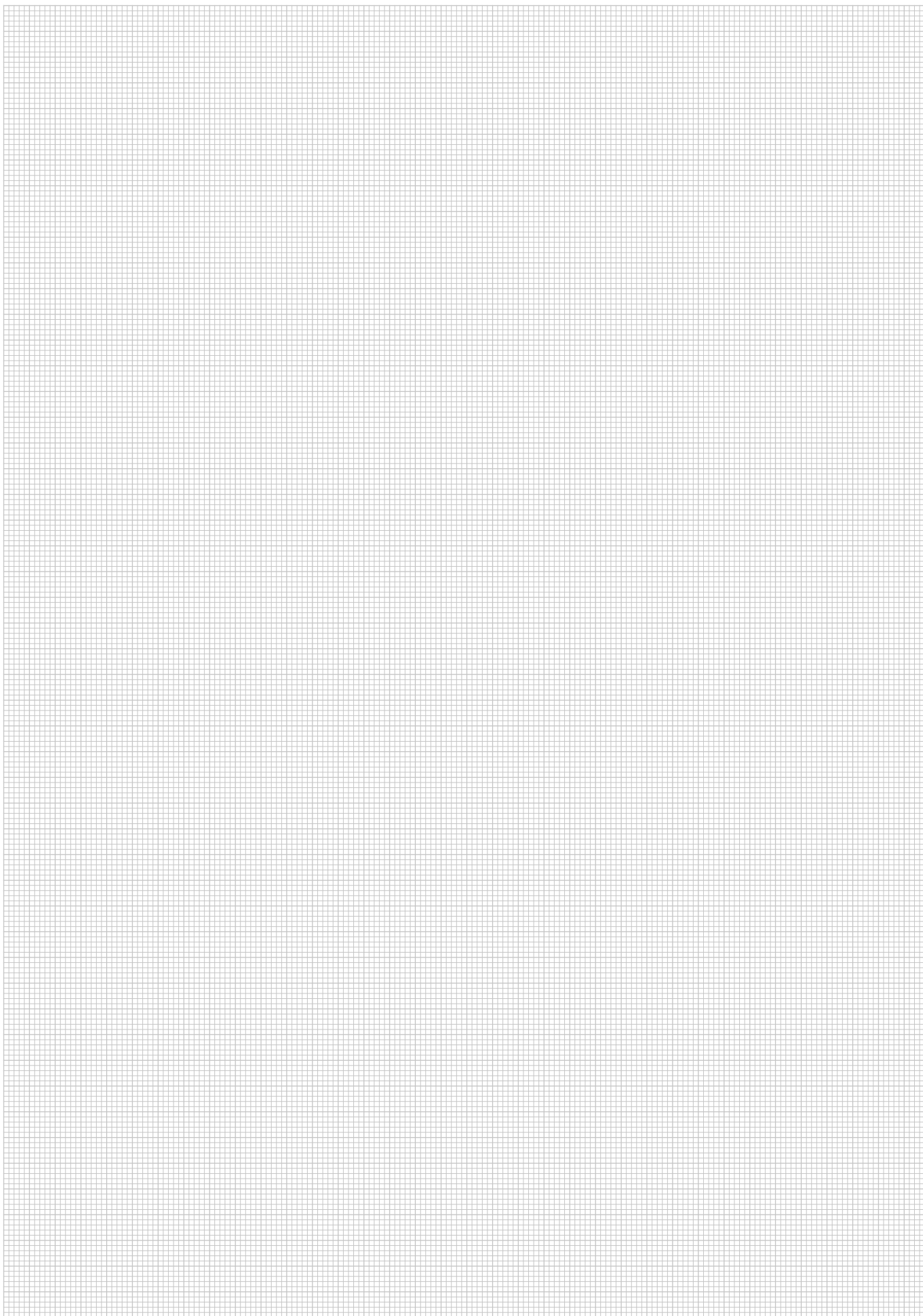
A large rectangular area filled with a fine grid pattern, intended for taking notes.

