

Veleprodaja i maloprodaja



27.07.2024

# DOPUNSKI KATALOG

Cijeli svijet na jednom mjestu!

2024



Vinjani bb, 88240 Posušje  
Bosna i Hercegovina  
[www.vokel.com](http://www.vokel.com)

**KERAMIKA | SANITARIJE | KLIMATIZACIJA | VODOMATERIJAL  
CENTRALNO GRIJANJE | LAMINATI I PARKETI**

<p><b>ACQUADANCE</b></p>		<p>Acquadance <b>str.1</b></p>
<p><i>Biamante</i></p>		<p>Biamante <b>str.6</b></p>
<p><b>RAINBOW</b></p>		<p>Rainbow <b>str.13</b></p>
<p>ceramicatecla italian luxury washbasins</p>		<p>Ceramica Tecla <b>str.16</b></p>
<p><b>MIFONTE</b></p>		<p>Mifonte <b>str.17</b></p>
<p><b>BiAL</b> EVERYTHING IN PLACE</p>		<p>Bial <b>str.27</b></p>
<p><b>FIN</b> KUPAONSKI RADIJATORI</p>		<p>Fin <b>str.29</b></p>
		<p>Terma <b>str.30</b></p>



 <p><b>bellavia</b> QUALITY FOR LIFE</p>		<p>Bellavia <b>str.31</b></p>
<p><b>QUADRO &amp; BELLA</b></p>		<p>Quadro i Bella <b>str.41</b></p>
 <p><b>GRUNDFOS</b></p>		<p>Grundfos <b>str.42</b></p>
 <p><b>IMPPUMPS</b> Intelligent Motor Pumps</p>		<p>Impumps <b>str.44</b></p>
 <p><b>kratki</b></p>		<p>Kratki <b>str.45</b></p>
 <p><b>PROGETTO IDEA STELLA</b></p>		<p>Progetto Idea Stella <b>str.61</b></p>
 <p><b>Melody</b></p>		<p>Melody <b>str.69</b></p>
<p><b>aquaart</b> WHERE INSPIRATION FLOWS</p>		<p>Aquaart <b>str.75</b></p>

<p>Royo®</p>		<p>Royo <b>str.83</b></p>
<p>JIKA Czech Bathrooms since 1878</p>		<p>Jika <b>str.84</b></p>
<p>Roca</p>		<p>Roca <b>str.85</b></p>
<p>PONTE GIULIO® creating solutions</p>		<p>Ponte Giulio <b>str.87</b></p>
<p>Garcia</p>		<p>Garcia <b>str.88</b></p>
<p>UNITAS®</p>		<p>Unitas <b>str.92</b></p>
<p>HARO®</p>		<p>Haro <b>str.94</b></p>
<p>aqua filter® USA</p>		<p>Aqua Filter <b>str.97</b></p>

<p><b>gorenje</b></p>		<p>Gorenje <b>str.98</b></p>
<p><b>KONČAR</b></p>		<p>Končar <b>str.100</b></p>
		<p>Ariston <b>str.101</b></p>
		<p>Dakota <b>str.107</b></p>
		<p>Vecamco <b>str.109</b></p>
		<p>Dab <b>str.113</b></p>
		<p>Kovina <b>str.114</b></p>

		<p>Danfoss <b>str.115</b></p>
		<p>C-Mix <b>str.118</b></p>
		<p>Profilpas <b>str.120</b></p>
		<p>Feal <b>str.134</b></p>
		<p>It-Flex <b>str.142</b></p>
		<p>Izoterm <b>str.144</b></p>
		<p>Vaillant <b>str.145</b></p>
		<p>Centrometal <b>str.154</b></p>



		<p>Thermoflux <b>str.157</b></p>
		<p>Soprema <b>str.158</b></p>
		<p>Aquasystem <b>str.160</b></p>
		<p>Solar <b>str.163</b></p>
		<p>Kan <b>str.165</b></p>
		<p>Caleffi <b>str.169</b></p>
		<p>Itap <b>str.170</b></p>
		<p>Imi Heimeier <b>str.171</b></p>

<h1>AXA</h1>		<p>Axa <b>str.173</b></p>
		<p>Impertek <b>str.174</b></p>
		<p>Neoperl <b>str.177</b></p>
		<p>Arco <b>str.192</b></p>
		<p>Fitt <b>str.195</b></p>
		<p>Swiss Aqua <b>str.196</b></p>
<h1>REMER</h1> <p>RUBINETTERIE</p>		<p>Remer <b>str.197</b></p>
		<p>Ikom <b>str.206</b></p>



		<p>Fiorini <b>str.208</b></p>
		<p>Weltplast <b>str.221</b></p>
		<p>Peštan <b>str.227</b></p>
		<p>Windy Plus <b>str.232</b></p>
<p><b>L-CLASSIC</b> WC ŠKOLJKE I UMIVAONICI</p>		<p>L-CLASSIC <b>str.233</b></p>
		<p>Unitas <b>str.234</b></p>
		<p>Elbi <b>str.235</b></p>
		<p>Aria <b>str.238</b></p>

<p><i>Biamante</i></p>		<p>Biamante <b>str.247</b></p>
<p><u>herstone</u></p>		<p>Herstone <b>str.255</b></p>
		<p>Argo <b>str.256</b></p>
		<p>Sonniger <b>str.273</b></p>
		<p>Digisu <b>str.278</b></p>
<p>Klick &amp; Hitze</p>		<p>Klick &amp; Hitze <b>str.279</b></p>
		<p>Engo <b>str.284</b></p>
		<p>Roca <b>str.290</b></p>

		<p>Martat <b>str.291</b></p>
		<p>Elba <b>str.300</b></p>
		<p>Aria <b>str.306</b></p>
		<p>Max alati <b>str.322</b></p>
		<p>Sika <b>str.337</b></p>
		<p>Arceus termoblok <b>str.342</b></p>
		<p>Aspecto <b>str.345</b></p>
		<p>Grohe <b>str.347</b></p>

		<p>Alati za keramičare <b>str.354</b></p>
<p>Klick &amp; Hitze</p>		<p>Odvajač nečistoća <b>str.366</b></p>
<p>Aria<sup>A</sup></p>		<p>Aria A <b>str.367</b></p>
		<p>Nagai <b>str.371</b></p>
		<p>Heatsense <b>str.373</b></p>
		<p>Profilitec <b>str.377</b></p>
<p>LAPIS</p>		<p>Lapis <b>str.382</b></p>

		<p>Oluk <b>str.386</b></p>
<p>alca drain</p>		<p>Alcadrain <b>str.390</b></p>
<p>BEMETA</p>		<p>Bemeta <b>str.392</b></p>
		<p>Liberama <b>str.394</b></p>
		<p>Cuprumfoma <b>str.398</b></p>



ALAMERE



**KARAKTERISTIKE:**

- Tri odvojena prebacivača, mesingana slavina i termostatska baterija
- Dimenzija: 160x20cm
- Zlatna završna obrada, nehrđajući čelik 304
- Uključen: ugrađen gornji tuš kromirani i dvije mlaznice, tuš ručica i držač tuš ručice, 2x40cm fleksibilno crijevo, 1,5m tuš crijevo

VOKEL ŠIFRA	BOJA	DIMENZIJA (cm)	ARTIKAL
<b>1703001</b>	ZLATNA	160 x 20	ST-88256

SELFOSS



**KARAKTERISTIKE:**

- Jedan prebacivač za tri načina i mesingana baterija
- Dimenzija: 160x20cm
- Crna završna obrada, nehrđajući čelik 304
- Uključen: gornji tuš kromirani i dvije mlaznice, tuš ručica i držač tuš ručice, 2x40cm fleksibilno crijevo

VOKEL ŠIFRA	BOJA	DIMENZIJA (cm)	ARTIKAL
<b>1703002</b>	CRNA	160 x 20	ST-88251



GULLFOSS

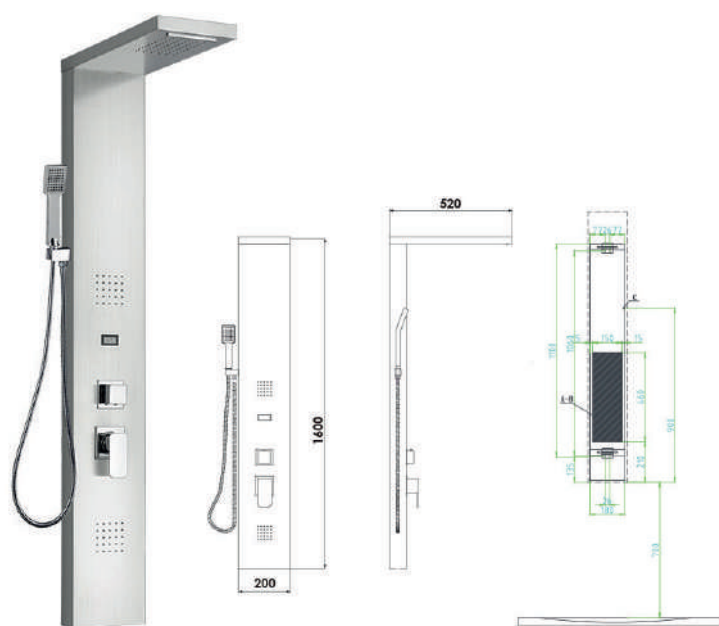

**KARAKTERISTIKE:**

- Jedan prebacivač za četiri načina, mesingana baterija i termometar
- Dimenzija: 140x20cm
- Završna obrada brušeni nehrđajući čelik
- Uključen: gornji tuš kromirani i vodopad, dvije mlaznice, tuš ručica i držač tuš ručice, 2x40cm, fleksibilno crijevo, 1,5m tuš crijevo

VOKEL ŠIFRA	BOJA	DIMENZIJA (cm)	ARTIKAL
<b>1703003</b>	KROM	140 x 20	ST-88235

LAHA

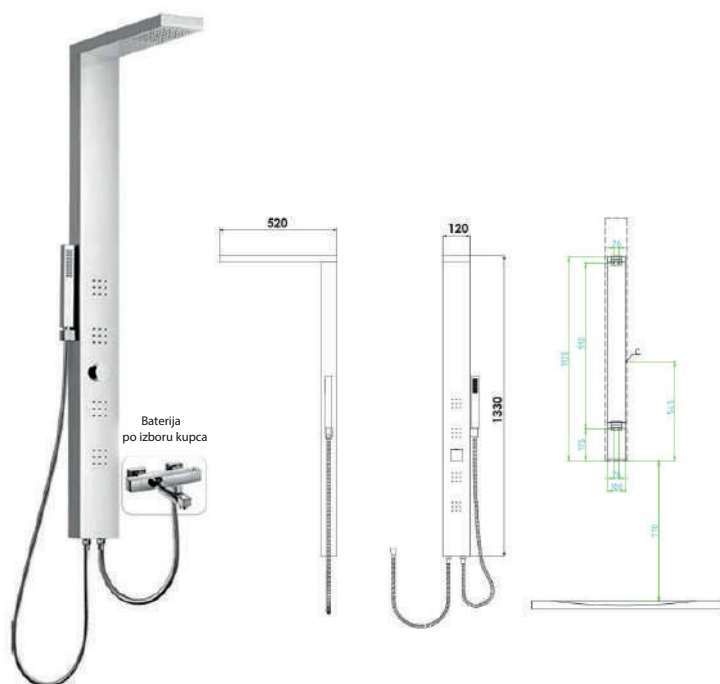

**KARAKTERISTIKE:**

- Jedan prebacivač za tri načina, bez baterije
- Dimenzija: 133x12cm
- Završna obrada brušeni nehrđajući čelik
- Uključen: gornji tuš i četiri mlaznice, tuš ručica i držač tuš ručice, 60cm fleksibilno crijevo, 1,5m tuš crijevo

VOKEL ŠIFRA	BOJA	DIMENZIJA (cm)	ARTIKAL
<b>1703004</b>	KROM	133 x 12	ST-88114

GRAND

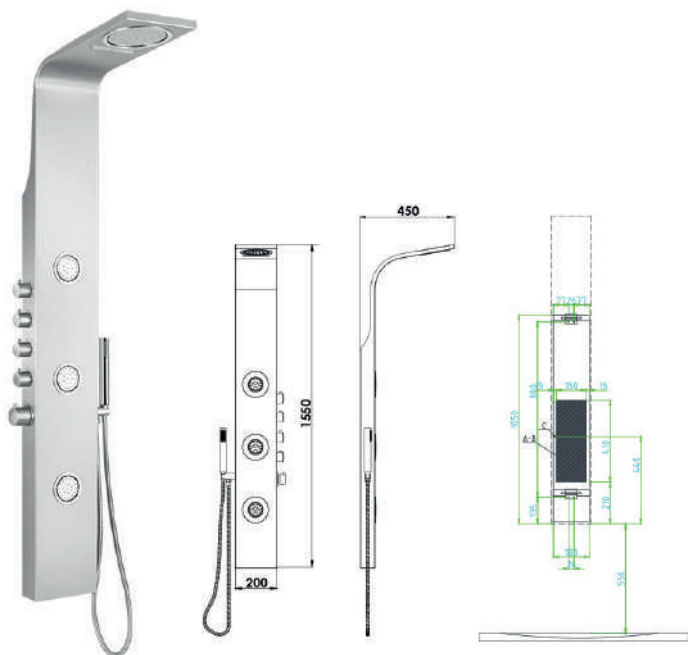

**KARAKTERISTIKE:**

- Četiri odvojena prebacivača i mesingana baterija
- Dimenzija: 155x20cm
- Završna obrada brušeni nehrđajući čelik
- Uključen: gornji tuš i vodopad, tri mlaznice, tuš ručica i držač tuš ručice, 2x40cm fleksibilno crijevo, 1,5m tuš crijevo

VOKEL ŠIFRA	BOJA	DIMENZIJA (cm)	ARTIKAL
<b>1703005</b>	KROM	155 x 20	ST-88166

VIRGINIA

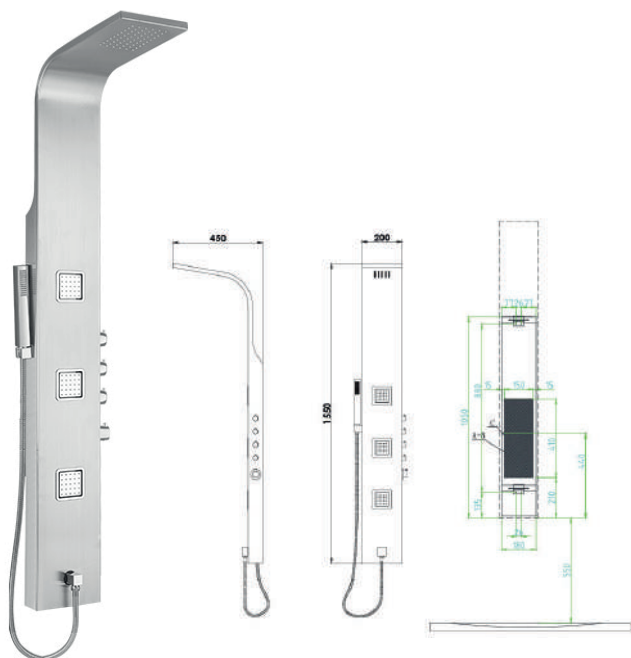

**KARAKTERISTIKE**

- Tri odvojena prebacivača i mesingana baterija
- Dimenzija: 155x20cm
- Završna obrada brušeni nehrđajući čelik
- Uključen: gornji tuš i tri mlaznice, tuš ručica i držač tuš ručice, 2x40cm flexibilno crijevo, 1,5m tuš crijevo

VOKEL ŠIFRA	BOJA	DIMENZIJA (cm)	ARTIKAL
<b>1703006</b>	KROM	155 x 20	ST-88161

INGA



**KARAKTERISTIKE:**

- Multifunkcionalni prebacivač, mesingana baterija i izljev
- Dimenzija: 150x20cm
- Završna obrada brušeni nehrđajući čelik
- Uključen: gornji tuš s 50 mlaznica, ugrađene 2 mlaznice, tuš ručica i držač tuš ručice, 2x40cm fleksibilno crijevo, 1,5m tuš crijevo

VOKEL ŠIFRA	BOJA	DIMENZIJA (cm)	ARTIKAL
<b>1703007</b>	KROM	150 x 20	ST-8839

BIGAR

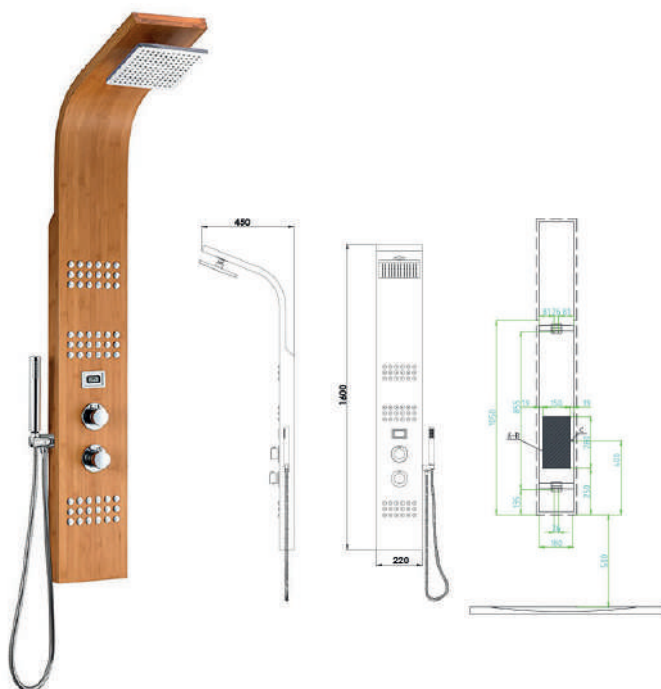

**KARAKTERISTIKE:**

- Jedan prebacivač za četiri načina, mesingana termostatska baterija i termometar
- Dimenzija: 160x22cm
- Materijal: bambus s vododtpornim premazom
- Uključen: ugrađen gornji tuš i tri mlaznice, tuš ručica, držač tuš ručice, 2x40cm fleksibilno crijevo, 1,5m tuš crijevo

VOKEL ŠIFRA	BOJA	DIMENZIJA (cm)	ARTIKAL
<b>1703008</b>	DRVO	160 x 22	ST-8311

## TUŠ RUŽA - OKRUGLA



VOKEL ŠIFRA	DIMENZIJA (Ø)	BOJA	ARTIKAL
<b>1703010</b>	20	KROM	ST-601
<b>1703011</b>	25	KROM	ST-616
<b>1703013</b>	30	KROM	ST-603

## TUŠ RUŽA - ČETVRTASTA

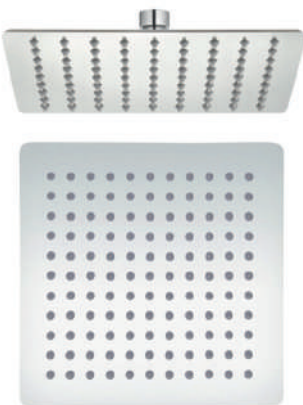

VOKEL ŠIFRA	DIMENZIJA (cm)	BOJA	ARTIKAL
<b>1703009</b>	20x20	KROM	ST-615
<b>1703012</b>	25x25	KROM	ST-617
<b>1703014</b>	30x30	KROM	ST-611

**NIRVANA**

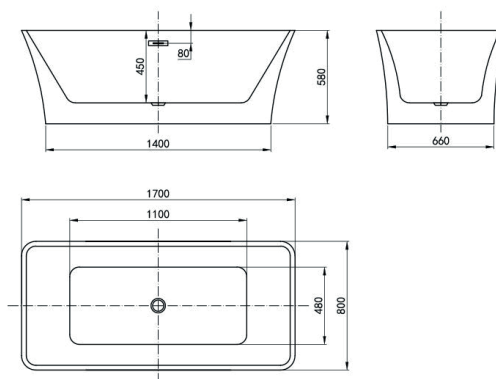

- samostojeća kada
- s gornjim dijelom sifona i preljevnom garniturom

ŠIFRA VOKEL  
**1705001**

DIMENZIJA  
170x80x58/O

MATERIJAL  
AKRIL

BOJA  
BIJELA

ARTIKAL  
GD-8120

**ARABICA**

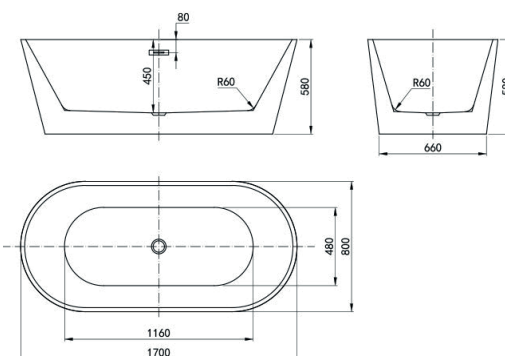

- samostojeća kada
- s gornjim dijelom sifona i preljevnom garniturom

ŠIFRA VOKEL  
**1705002**

DIMENZIJA  
170x80x58/O

MATERIJAL  
AKRIL

BOJA  
BIJELA

ARTIKAL  
GD-8201

**ARABICA BLACK**

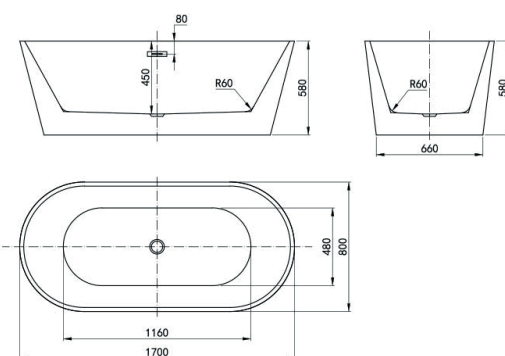

- samostojeća kada
- s gornjim dijelom sifona i preljevnom garniturom

ŠIFRA VOKEL  
**1705003**

DIMENZIJA  
170x80x58/O

MATERIJAL  
AKRIL

BOJA  
CRNA

ARTIKAL  
GD-8120WB

## ZENONA

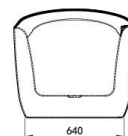
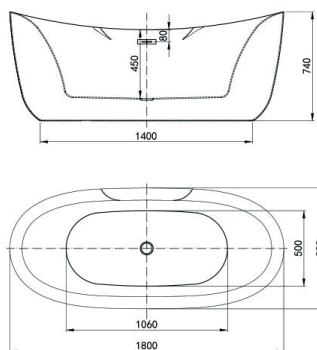

- samostojeća kada
- s gornjim dijelom sifona i preljevnom garniturom

ŠIFRA VOKEL

**1705004**

DIMENZIJA

180x80x74/O

MATERIJAL

AKRIL

BOJA

BIJELA

ARTIKAL

GD-8305

## LAMIA LIJEVA

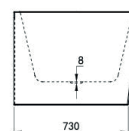
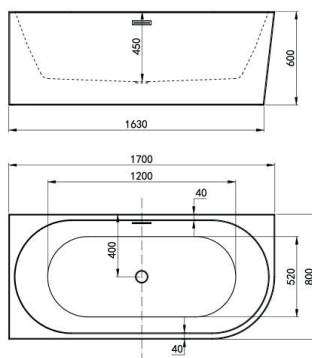

- samostojeća kada
- s gornjim dijelom sifona i preljevnom garniturom

ŠIFRA VOKEL

**1705005**

DIMENZIJA

170x80x60/O

MATERIJAL

AKRIL

BOJA

BIJELA

ARTIKAL

GD-8312L

## LAMIA DESNA

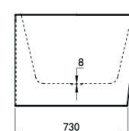
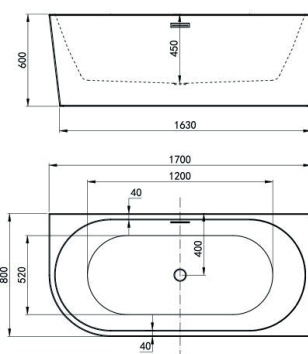

- samostojeća kada
- s gornjim dijelom sifona i preljevnom garniturom

ŠIFRA VOKEL

**1705006**

DIMENZIJA

170x80x60/O

MATERIJAL

AKRIL

BOJA

BIJELA

ARTIKAL

GD-8312R



MARIS WHITE

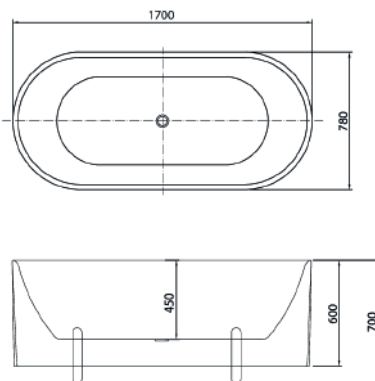

- samostojeća kada
- s gornjim dijelom sifona, preljevnom garniturom i ukrasnim nogama

ŠIFRA VOKEL

**1730002**

DIMENZIJA

170x78x70

MATERIJAL

AKRIL

BOJA

BIJELA

ARTIKAL

158778W

MARIS GREY

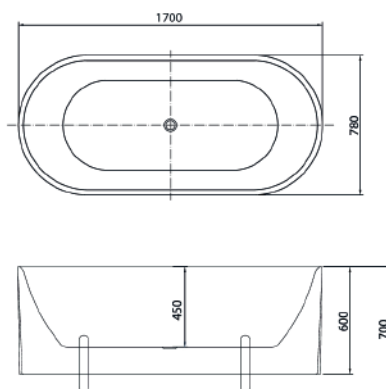

- samostojeća kada
- s gornjim dijelom sifona, preljevnom garniturom i ukrasnim nogama

ŠIFRA VOKEL

**1730001**

DIMENZIJA

170x78x70

MATERIJAL

AKRIL

BOJA

SIVA

ARTIKAL

158778G/W

EVIAN WHITE

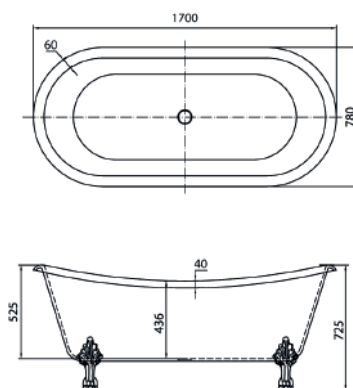

- samostojeća kada
- s uključenim sifonom i ukrasnim silver nogama

ŠIFRA VOKEL

**1730003**

DIMENZIJA

170x78x72,5

MATERIJAL

AKRIL

BOJA

BIJELA

ARTIKAL

EB05778W

## EVIAN GREY

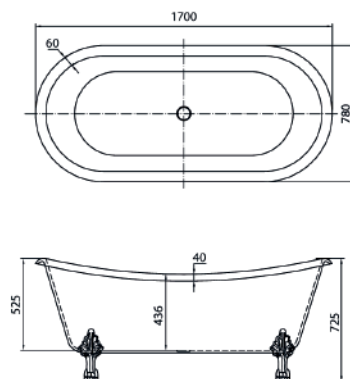

- samostojeća kada
- s uključenim sifonom i ukrasnim silver nogama

ŠIFRA VOKEL

**1730004**

DIMENZIJA

170x78x72,5

MATERIJAL

AKRIL

BOJA

SIVA

ARTIKAL

EB05778G/W

## GAELA WHITE

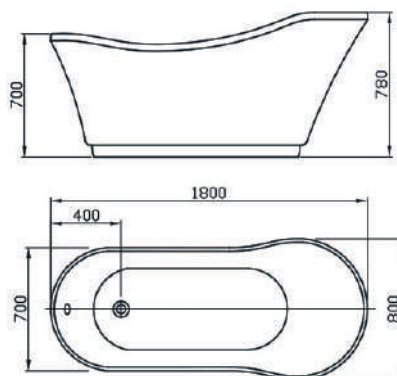

- samostojeća kada
- s gornjim dijelom sifona i prelivnom garniturom

ŠIFRA VOKEL

**1729012**

DIMENZIJA

180x78x78

MATERIJAL

AKRIL

BOJA

BIJELA

ARTIKAL

PY180-98

## GAELA BLACK

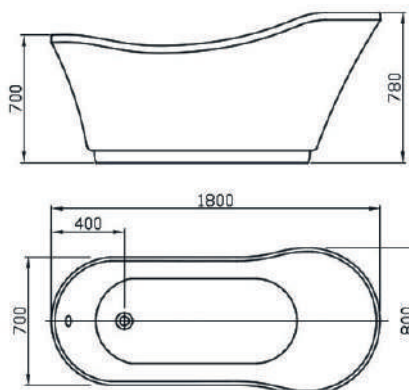

- samostojeća kada
- s gornjim dijelom sifona i prelivnom garniturom

ŠIFRA VOKEL

**1729011**

DIMENZIJA

180x78x78

MATERIJAL

AKRIL

BOJA

CRNA

ARTIKAL

PY180-98B

FREA BEIGE

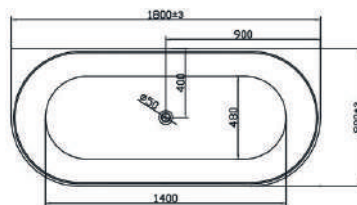
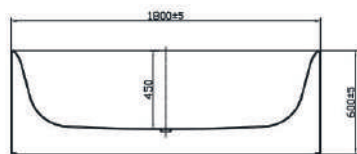

- samostojeća kada
- s gornjim dijelom sifona i preljevnom garniturom

ŠIFRA VOKEL

**1729013**

DIMENZIJA

180x80x60

MATERIJAL

AKRIL

BOJA

BIGE

ARTIKAL

PY180-104

## MANDY WHITE



- lijevani mramor
- tuš kada s pokrovom matte-white
- za instalaciju na pod
- H = 3cm

ŠIFRA VOKEL	DIMENZIJA	BOJA	ARTIKAL
<b>1729001</b>	90x90	WHITE	MDXF12-MW
<b>1729022</b>	100x80	WHITE	MXDF12-MW
<b>1729023</b>	100x90	WHITE	MXDF12-MW
<b>1729024</b>	110x80	WHITE	MXDF12-MW
<b>1729025</b>	110x90	WHITE	MXDF12-MW
<b>1729002</b>	120x80	WHITE	MXDF12-MW
<b>1729003</b>	120x90	WHITE	MXDF12-MW
<b>1729004</b>	140x80	WHITE	MXDF12-MW
<b>1729005</b>	140x90	WHITE	MXDF12-MW
<b>1729026</b>	160x80	WHITE	MXDF12-MW
<b>1729027</b>	160x90	WHITE	MXDF12-MW

Preporučeni sifon:

<b>0404440</b>	SIFON FI 90 ZA TUŠ KADE, BEZ POKROVA H=65 mm	ART.563180
----------------	--	------------

## MANDY BLACK



- lijevani mramor
- tuš kada s pokrovom matte-black
- za instalaciju na pod
- H = 3cm

ŠIFRA VOKEL	DIMENZIJA	BOJA	ARTIKAL
<b>1729006</b>	90x90	BLACK	MDXF12-MB
<b>1729028</b>	100x80	BLACK	MXDF12-MB
<b>1729029</b>	100x90	BLACK	MXDF12-MB
<b>1729030</b>	110x80	BLACK	MXDF12-MB
<b>1729031</b>	110x90	BLACK	MXDF12-MB
<b>1729007</b>	120x80	BLACK	MXDF12-MB
<b>1729008</b>	120x90	BLACK	MXDF12-MB
<b>1729009</b>	140x80	BLACK	MXDF12-MB
<b>1729010</b>	140x90	BLACK	MXDF12-MB
<b>1729032</b>	160x80	BLACK	MXDF12-MB
<b>1729033</b>	160x90	BLACK	MXDF12-MB

Preporučeni sifon:

<b>0404440</b>	SIFON FI 90 ZA TUŠ KADE, BEZ POKROVA H=65 mm	ART.563180
----------------	--	------------

## MANDY GREY



- lijevani mramor
- tuš kada s pokrovom matte-grey
- za instalaciju na pod
- H = 3cm

ŠIFRA VOKEL	DIMENZIJA	BOJA	ARTIKAL
<b>1729014</b>	90x90	GREY	MXDF12-MG
<b>1729034</b>	100x80	GREY	MXDF12-MG
<b>1729035</b>	100x90	GREY	MXDF12-MG
<b>1729036</b>	110x80	GREY	MXDF12-MG
<b>1729037</b>	110x90	GREY	MXDF12-MG
<b>1729015</b>	120x80	GREY	MXDF12-MG
<b>1729016</b>	120x90	GREY	MXDF12-MG
<b>1729017</b>	140x80	GREY	MXDF12-MG
<b>1729018</b>	140x90	GREY	MXDF12-MG
<b>1729038</b>	160x80	GREY	MXDF12-MG
<b>1729039</b>	160x90	GREY	MXDF12-MG

Preporučeni sifon:

<b>0404440</b>	SIFON FI 90 ZA TUŠ KADE, BEZ POKROVA H=65 mm	ART.563180
----------------	--	------------

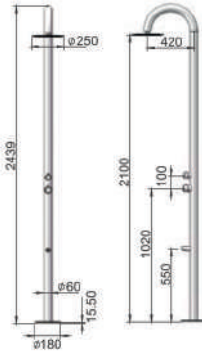

Rainbow

**ML9007**

Visina 2439 mm

Promjer 60 mm

Tuš ruža promjera 250 mm

Mat završna obrada

Š. VOKEL

OPIS

**1192003**

VANJSKI TUŠ RAINBOW ART.ML9007

Rainbow Black

**ML9007-MB**

Visina 2439 mm

Promjer 60 mm

Tuš ruža promjera 250 mm

Boja - crna

Mat završna obrada

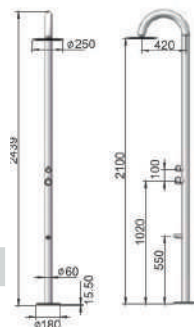

Š. VOKEL

OPIS

**1192002**

VANJSKI TUŠ RAINBOW ART.ML9007-MB





### KARTUŠA

Š. VOKEL	OPIS	ART.
<b>1723001</b>	KARTUŠA ZA ML9007 I ML9007-MB	50001



### PREBACIVAČ

Š. VOKEL	OPIS	ART.
<b>1723002</b>	PREBACIVAČ ZA ML9007 I ML9007-MB	50002



### RUČICA ZA KARTUŠU

Š. VOKEL	OPIS	ART.
<b>1723003</b>	RUČICA ZA KARTUŠU ZA ML9007	50003



### RUČICA ZA PREBACIVAČ

Š. VOKEL	OPIS	ART.
<b>1723004</b>	RUČICA ZA PREBACIVAČ ZA ML9007	50004



### TUŠ RUŽA Ø 25 ZA ML9007

Š. VOKEL	OPIS	ART.
<b>1723005</b>	TUŠ RUŽA ZA ML9007	50005



### RUČICA ZA KARTUŠU BLACK

Š. VOKEL	OPIS	ART.
<b>1723006</b>	RUČICA ZA KARTUŠU BLACK ZA ML9007-MB	50006



### RUČICA ZA PREBACIVAČ

Š. VOKEL	OPIS	ART.
<b>1723007</b>	RUČICA ZA PREBACIVAČ BLACK ZA ML9007-MB	50007



### TUŠ RUŽA Ø 25

Š. VOKEL	OPIS	ART.
<b>1723008</b>	TUŠ RUŽA BLACK ZA ML9007-MB	50008

# RAINBOW VANJSKI TUŠ ML9007 INSTALACIJA

**1** ODREĐITI POZICIJU UGRADNICE C-box-a U ODNOSU NA MJESTO TUSIRANJA (udaljenost između njih je 750 mm), NAPRAVITI RUPU NA OSNOVU VELIČINE C-box-a.

VERTIKALNO OD MJESTA TUSIRANJA  
ZA HLADNU VODU  
ZA TOPLU VODU

**2** SPOJITI CIJEVI TOPLI I HLADNE VODE NA UGRADENI C-box, PROUVJERITI SPOJENJE DA NE PUSTAJU VODU.

**3**

SREDNJA LINIJA  
DONJA LINIJA

Osigurajte da je C-box vertikalno i centrirano prema Vama. Pričvrstite C-box u rupu na dnu sa 4 ekspanzijska vijka MB, pobrinite se da podne pločice budu više od donje linije i niže od srednje linije C-box-a.

**4**

Uklonite poklopac C-box-a i čepove za toplu i hladnu vodu. Izrežite dodatni gornji dio C-box-a.

8 mm IMBUS KLJUČ

**5**

Umetnite donju cijev u C-box, spojite donju ploču s C-boxom s 4 vijaka, zatim gurnite donju ukrasnu rozetu na pod.

5mm 6-IMBUS KLJUČ

**6**

Umetnite gornju cijev u donju cijev, sa stražnje strane na dvije cijevi poklopi da dobijemo jedan pravokutnik, zavijte vijak na stražnjoj strani cijevi kako biste dobili ispravnu instalaciju. Priključite ručni tuš s fleksibilnim crijevom ako ga imate. (ako stavke imaju izljev, imajte na umu da smo ga već instalirali.)

2.5mm 6-IMBUS KLJUČ

750

## TWENTY

### UMIVAONIK TWENTY TOTAL BOWL

Š.VOKEL	DIMENZIJE	BOJA	ŠIFRA ARTIKLA	PAKIRANJE
<b>1195001</b>	46x61	BIJELA	TW01011	1
<b>1195005</b>	46x81	BIJELA	TW05011	1
<b>1195009</b>	46x101	BIJELA	TW09011	1
<b>1195013</b>	46x121	BIJELA	TW13011	1

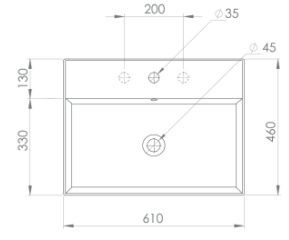

### UMIVAONIK TWENTY CENTRAL BOWL

#### SREDNJI

Š.VOKEL	DIMENZIJE	BOJA	ŠIFRA ARTIKLA	PAKIRANJE
<b>1195002</b>	46x61	BIJELA	TW02011	1
<b>1195006</b>	46x81	BIJELA	TW06011	1
<b>1195010</b>	46x101	BIJELA	TW10011	1
<b>1195014</b>	46x121	BIJELA	TW14011	1

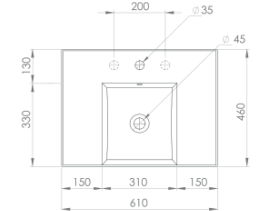

### UMIVAONIK TWENTY RIGHT BOWL

#### DESNI

Š.VOKEL	DIMENZIJE	BOJA	ŠIFRA ARTIKLA	PAKIRANJE
<b>1195003</b>	46x61	BIJELA	TW03011	1
<b>1195007</b>	46x81	BIJELA	TW07011	1
<b>1195011</b>	46x101	BIJELA	TW11011	1
<b>1195015</b>	46x121	BIJELA	TW15011	1

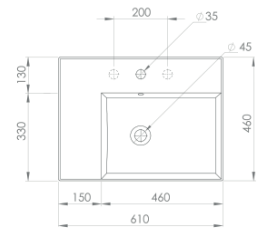

### UMIVAONIK TWENTY LEFT BOWL

#### LIJEVI

Š.VOKEL	DIMENZIJE	BOJA	ŠIFRA ARTIKLA	PAKIRANJE
<b>1195004</b>	46x61	BIJELA	TW04011	1
<b>1195008</b>	46x81	BIJELA	TW08011	1
<b>1195012</b>	46x101	BIJELA	TW12011	1
<b>1195016</b>	46x121	BIJELA	TW16011	1

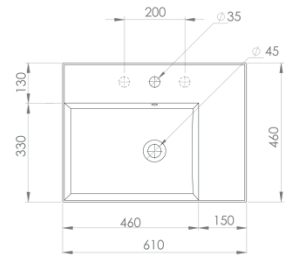

### UMIVAONIK TWENTY DOUBLE BOWL- DUPLI

#### 121cm

Š.VOKEL	DIMENZIJE	BOJA	ŠIFRA ARTIKLA	PAKIRANJE
<b>1195017</b>	46x121	BIJELA	TW17011	1

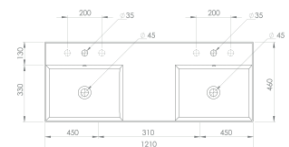

Š.VOKEL	OPIS
<b>1196003</b>	NOSAČ UMIVAONIKA INOX TIP - 800 B. T. P mod. TWENTY
<b>1196002</b>	NOSAČ UMIVAONIKA INOX TIP - 1000 B.T.P mod. TWENTY
<b>1196001</b>	NOSAČ UMIVAONIKA INOX TIP - 1200 B.T.P mod. TWENTY
<b>1196006</b>	NOSAČ UMIVAONIKA CRNI TIP - 800 B. T. P mod. TWENTY
<b>1196005</b>	NOSAČ UMIVAONIKA CRNI TIP - 1000 B. T. P mod. TWENTY
<b>1196004</b>	NOSAČ UMIVAONIKA CRNI TIP - 1200 B. T. P mod. TWENTY

Š.VOKEL	OPIS
<b>1704001</b>	POLICA BIANCHISSIMO QUARELLA 2cm 81 TWENTY (2ND)
<b>1704002</b>	POLICA BIANCHISSIMO QUARELLA 2CM 101 TWENTY (2ND)
<b>1704003</b>	POLICA BIANCHISSIMO QUARELLA 2cm 121 TWENTY (2ND)



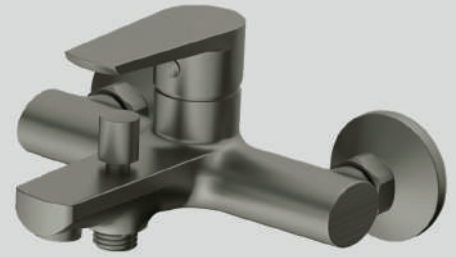

MIFONTE

GUN METAL

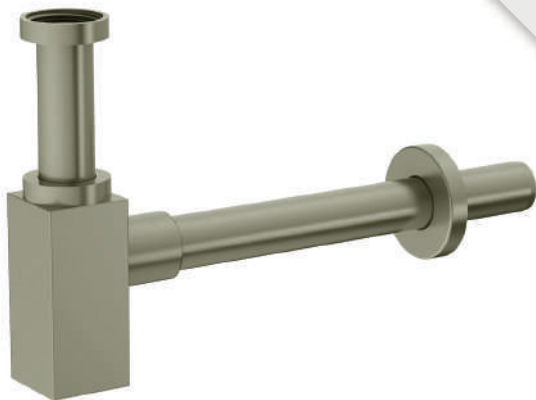

**VRHUNSKI DIZAJN  
ODLIČNA KVALITETA  
IZRAZITA FUNKCIONALNOST**

**OTPORNOST NA  
OTISKE PRSTIJU**

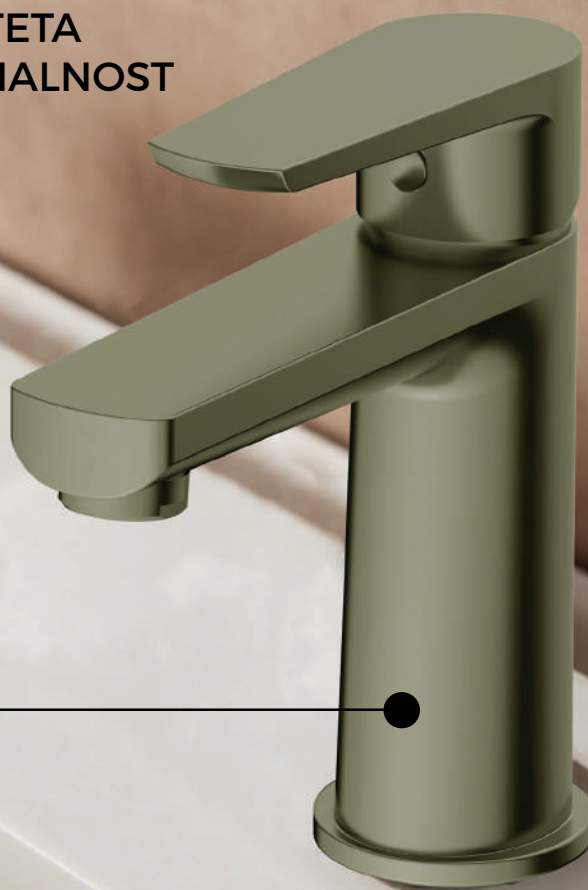
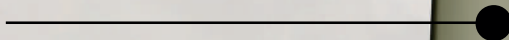

Kod završene obrade MIFONTE GUN METAL kolekcije je korištena PVD tehnologija (Physical Vapor Deposition). Ovaj vrhunski proces stvara molekularnu vezu sa slavinom što rezultira najtrajnijom završnom obradom koja je danas dostupna. Proizvodi s PVD završnom obradom neće korodirati, promijeniti boju ili potamniti.

Mifonte GUN METAL program posjeduje FINGER RESIST SLOJ koji sprječava ostavljanje otisaka prstiju





BATERIJA ZA UMIVAONIK

ŠIFRA VOKEL	BOJA	ŠIFRA ARTIKLA	PAKIRANJE
<b>1189025</b>	GUN METAL	1721H6142 GM	1



BATERIJA ZA UMIVAONIK VISOKA

ŠIFRA VOKEL	BOJA	ŠIFRA ARTIKLA	PAKIRANJE
<b>1189026</b>	GUN METAL	1721-1H6142 GM	1



BATERIJA ZA BIDE

ŠIFRA VOKEL	BOJA	ŠIFRA ARTIKLA	PAKIRANJE
<b>1189027</b>	GUN METAL	1722H6142 GM	1



BATERIJA ZA KADU  
S CRIJEVOM I TUŠ RUČICOM

ŠIFRA VOKEL	BOJA	ŠIFRA ARTIKLA	PAKIRANJE
<b>1189028</b>	GUN METAL	1723H6142 GM	1

**RIO GRANDE TUŠ SUSTAV**

S CRIJEVOM, RUČICOM I TUŠ RUŽOM 25x25

ŠIFRA VOKEL	BOJA	ŠIFRA ARTIKLA	PAKIRANJE
<b>1191081</b>	GUN METAL	20B GM	1



### TUŠ RUČICA - ČETVRTASTA

ŠIFRA VOKEL	BOJA	ŠIFRA ARTIKLA	PAKIRANJE
<b>1191094</b>	GUN METAL	HS30 GM	1



### NADGLAVNI TUŠ

250 x 250

ŠIFRA VOKEL	BOJA	ŠIFRA ARTIKLA	PAKIRANJE
<b>1191093</b>	GUN METAL	RS07 GM	1



### SIFON - ČETVRTASTI

ŠIFRA VOKEL	BOJA	ŠIFRA ARTIKLA	PAKIRANJE
<b>1191091</b>	GUN METAL	SF07 GM	1



### CRIJEVO ZA TUŠ /PVC

1,5 m

ŠIFRA VOKEL	BOJA	ŠIFRA ARTIKLA	PAKIRANJE
<b>1191098</b>	GUN METAL	HS01 GM	1(BLISTER)



### KUTNI VENTIL - ČETVRTASTI 1/2" - 3/8"

ŠIFRA VOKEL	BOJA	ŠIFRA ARTIKLA	PAKIRANJE
<b>1191090</b>	GUN METAL	YD53GM	1



### PILETA KLIK-KLAK

5/4" BEZ RUPE ZA PRELJEV

ŠIFRA VOKEL	BOJA	ŠIFRA ARTIKLA	PAKIRANJE
<b>1191089</b>	GUN METAL	P23 GM	1



### PILETA

5/4" BEZ RUPE ZA PRELJEV I BEZ KLIK-KLAKA

ŠIFRA VOKEL	BOJA	ŠIFRA ARTIKLA	PAKIRANJE
<b>1191092</b>	GUN METAL	P46 GM	1

VJEŠALICA



ŠIFRA VOKEL	BOJA	ŠIFRA ARTIKLA	PAKIRANJE
<b>1715090</b>	GUN METAL	8207AGM	1

DUPLA VJEŠALICA



ŠIFRA VOKEL	BOJA	ŠIFRA ARTIKLA	PAKIRANJE
<b>1715091</b>	GUN METAL	8207GM	1

DRŽAČ RUČNIKA 60 cm



ŠIFRA VOKEL	BOJA	ŠIFRA ARTIKLA	PAKIRANJE
<b>1715092</b>	GUN METAL	8203GM	1

DRŽAČ RUČNIKA 23 cm



ŠIFRA VOKEL	BOJA	ŠIFRA ARTIKLA	PAKIRANJE
<b>1715093</b>	GUN METAL	8206GM	1

DRŽAČ TOALET PAPIRA



ŠIFRA VOKEL	BOJA	ŠIFRA ARTIKLA	PAKIRANJE
<b>1715094</b>	GUN METAL	8205GM	1

WC ČETKA



ŠIFRA VOKEL	BOJA	ŠIFRA ARTIKLA	PAKIRANJE
<b>1715095</b>	GUN METAL	8208GM	1

DOZATOR SAPUNA S DRŽAČEM



ŠIFRA VOKEL	BOJA	ŠIFRA ARTIKLA	PAKIRANJE
<b>1715097</b>	GUN METAL	8211GM	1

DRŽAČ ČAŠE S ČAŠOM



ŠIFRA VOKEL	BOJA	ŠIFRA ARTIKLA	PAKIRANJE
<b>1715096</b>	GUN METAL	8210GM	1



## KUTNI ETAŽER

NOTINO GUN METAL

ŠIFRA VOKEL	BOJA	ŠIFRA ARTIKLA	PAKIRANJE
<b>1715098</b>	GUN METAL	D1013GM	1



## DUPLI KUTNI ETAŽER

NOTINO GUN METAL

ŠIFRA VOKEL	BOJA	ŠIFRA ARTIKLA	PAKIRANJE
<b>1715099</b>	GUN METAL	D1014GM	1





## BATERIJA ZA UMIVAONIK

ŠIFRA VOKEL	BOJA	ŠIFRA ARTIKLA	PAKIRANJE
<b>1742001</b>	KROM	3381	1



## BATERIJA ZA UMIVAONIK VISOKA

ŠIFRA VOKEL	BOJA	ŠIFRA ARTIKLA	PAKIRANJE
<b>1742006</b>	KROM	3381-1	1



## BATERIJA ZA BIDE

ŠIFRA VOKEL	BOJA	ŠIFRA ARTIKLA	PAKIRANJE
<b>1742002</b>	KROM	3382	1



## BATERIJA ZA TUŠ I KADU

S CRIJEVOM, RUČICOM I ZIDNIM DRŽAČEM TUŠA

ŠIFRA VOKEL	BOJA	ŠIFRA ARTIKLA	PAKIRANJE
<b>1742003</b>	KROM	3383	1



## BATERIJA ZA TUŠ

S CRIJEVOM, RUČICOM I ZIDNIM DRŽAČEM TUŠA

ŠIFRA VOKEL	BOJA	ŠIFRA ARTIKLA	PAKIRANJE
<b>1742004</b>	KROM	3384	1



## BATERIJA ZA KUHINJU

ŠIFRA VOKEL	BOJA	ŠIFRA ARTIKLA	PAKIRANJE
<b>1742005</b>	KROM	3385	1



## JANA

ŠIFRA VOKEL	BOJA	ŠIFRA ARTIKLA	PAKIRANJE
<b>1190016</b>	KROM	3648	1



## NORIN

ŠIFRA VOKEL	BOJA	ŠIFRA ARTIKLA	PAKIRANJE
<b>1190017</b>	KROM	0618-2	1



## HIGIJENSKA BATERIJA

S VENTILOM, CRIJEVOM, RUČICOM

ŠIFRA VOKEL	BOJA	ŠIFRA ARTIKLA	PAKIRANJE
<b>1191101</b>	BRUSHED GOLD	1789	1



## KONZOLA

ŠIFRA VOKEL	BOJA	ŠIFRA ARTIKLA	PAKIRANJE
<b>1191066</b>	BRUSHED GOLD	XS04016101G	1



KOZMETIČKO OGLEDALO

NOTINO CHROME - SAMOSTOJEĆE

ŠIFRA VOKEL	BOJA	ŠIFRA ARTIKLA	PAKIRANJE
<b>1715110</b>	KROM	4003CR	1



KOZMETIČKO OGLEDALO

NOTINO BLACK - SAMOSTOJEĆE

ŠIFRA VOKEL	BOJA	ŠIFRA ARTIKLA	PAKIRANJE
<b>1715111</b>	CRNA	4003B	1



KOZMETIČKO OGLEDALO

NOTINO GOLD - SAMOSTOJEĆE

ŠIFRA VOKEL	BOJA	ŠIFRA ARTIKLA	PAKIRANJE
<b>1715111</b>	GOLD	4003G	1

# ALTA - kupaonski radijator



BOJA



BIJELA

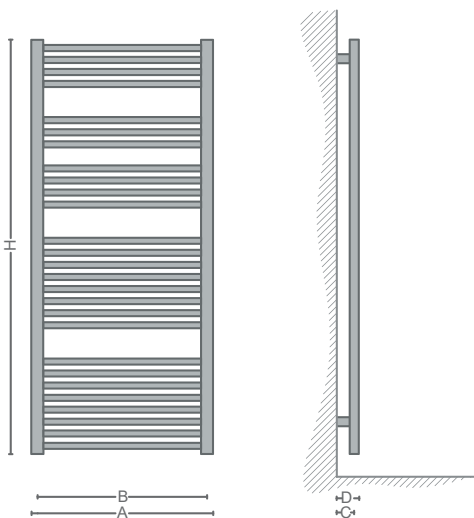
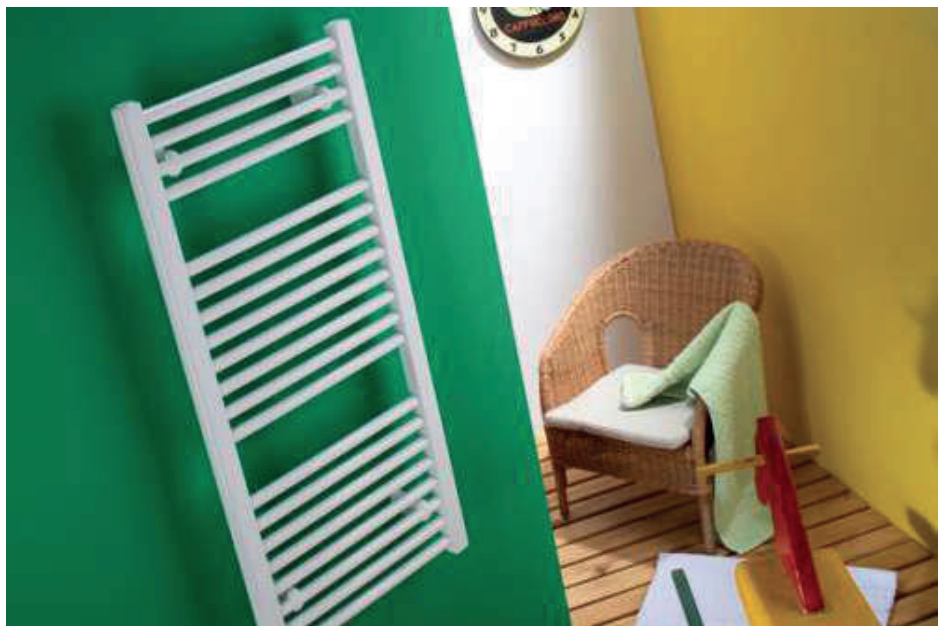

ŠIFRA VOKEL	A (mm)	H (mm)	B (mm)	C (mm)	D (mm)	m (kg)	P <sub>1</sub> (Watt)	P <sub>2</sub> (Watt)
<b>0611041</b>	450	974	400 / 50	70-90	85-105	7.47	388	400
<b>0611042</b>	450	1374	400 / 50	70-90	85-105	10.47	583	600
<b>0611043</b>	450	1694	400 / 50	70-90	85-105	13.07	718	800
<b>0611044</b>	600	974	550 / 50	70-90	85-105	9.34	521	600
<b>0611045</b>	600	1374	550 / 50	70-90	85-105	12.92	751	800
<b>0611046</b>	600	1694	550 / 50	70-90	85-105	15.66	916	800
	750	974	700 / 50	70-90	85-105	11.27	655	600
<b>0611055</b>	750	1374	700 / 50	70-90	85-105	15.77	919	800
	750	1694	700 / 50	70-90	85-105	19.07	1113	1000

BOJE PO NARUDŽBI

02	03	04
ANTRACIT	BEŽ	PLATINASTA

# SORA - kupaonski radijator

## BOJA



BIJELA

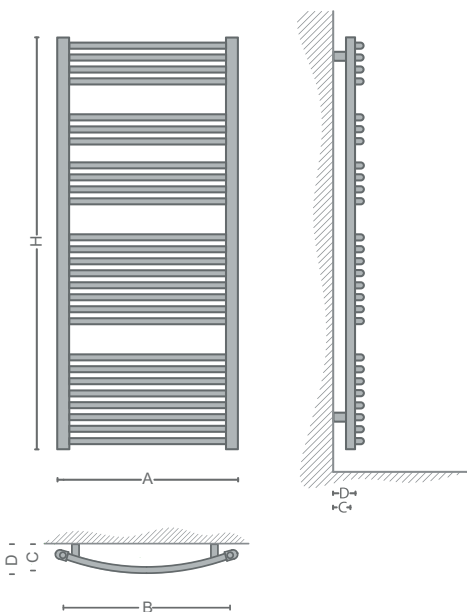

ŠIFRA VOKEL	A (mm)	H (mm)	B (mm)	C (mm)	D (mm)	m (kg)	P <sub>1</sub> (Watt)	P <sub>2</sub> (Watt)
<b>0611047</b>	450	974	395 / 50	60 / 95	105-125	7.47	388	400
<b>0611048</b>	450	1374	395 / 50	60 / 95	105-125	10.47	583	600
<b>0611049</b>	450	1694	395 / 50	60 / 95	105-125	13.07	718	800
<b>0611050</b>	600	974	545 / 50	60 / 100	115-135	9.34	521	600
<b>0611051</b>	600	1374	545 / 50	60 / 100	115-135	12.92	751	800
<b>0611052</b>	600	1694	545 / 50	60 / 100	115-135	15.66	916	800
	750	974	695 / 50	60 / 110	120-140	11.27	655	600
	750	1374	695 / 50	60 / 110	120-140	15.77	919	800
	750	1694	695 / 50	60 / 110	120-140	19.07	1113	1000

## BOJE PO NARUDŽBI

02	03	04
ANTRACIT	BEŽ	PLATINASTA



## "FIN"

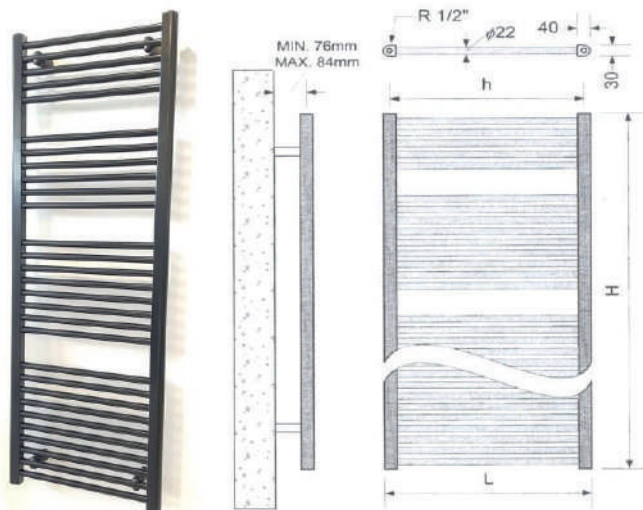

ŠIFRA VOKEL	NAZIV ARTIKLA	VISINA H (mm)	DUŽINA L (mm)	OSNI RAZMAK PRIKLJUČKA h (mm)	TOPLINSKI UČINAK Q(W) 90/70/20°C	SADRŽAJ VODE U RADIJATORU (Lit.)
39112	KUPAONSKI RADIJATOR FIN R01 BIJELI	770	500	460	555	3,65
39113	KUPAONSKI RADIJATOR FIN R02 BIJELI	770	600	560	645	4,16
39114	KUPAONSKI RADIJATOR FIN R04 BIJELI	980	500	460	678	4,47
39115	KUPAONSKI RADIJATOR FIN R05 BIJELI	980	600	560	784	5,06
39116	KUPAONSKI RADIJATOR FIN R07 BIJELI	1190	500	460	841	5,55
39117	KUPAONSKI RADIJATOR FIN R08 BIJELI	1190	600	560	915	6,30
39118	KUPAONSKI RADIJATOR FIN R10 BIJELI	1485	500	460	1029	6,79
39119	KUPAONSKI RADIJATOR FIN R11 BIJELI	1485	600	560	1192	7,71
39120	KUPAONSKI RADIJATOR FIN R13 BIJELI	1740	500	460	1225	8,10
39121	KUPAONSKI RADIJATOR FIN R14 BIJELI	1740	600	560	1422	9,19

1455001	KUPAONSKI RADIJATOR FIN R07 CRNI	1190	500	460	841	5,55
1455002	KUPAONSKI RADIJATOR FIN R08 CRNI	1190	600	560	915	6,30
1455003	KUPAONSKI RADIJATOR FIN R10 CRNI	1485	500	460	1029	6,79
1455004	KUPAONSKI RADIJATOR FIN R11 CRNI	1485	600	560	1192	7,71
1455005	KUPAONSKI RADIJATOR FIN R13 CRNI	1740	500	460	1225	8,10
1455006	KUPAONSKI RADIJATOR FIN R14 CRNI	1740	600	560	1422	9,19

## MOA GRIJAČI

### Zadivljujući minimalizam

MOA je grijač dizajniran s pažnjom na svaki detalj, prepoznatljiv po minimalističkom obliku i funkcionalnosti. Izuzetnu udobnost osigurava funkcija sušenja, zahvaljujući kojoj se može automatski promijeniti temperatura grijanja ili potpuno isključiti grijač. Veliki gumbi sa signaliziranjem trenutne i zadane temperature čine njegov rad intuitivnim. Grijač ima dvostupanjski sustav protiv pregrijavanja i kratkog spoja.

### FUNKCIONALNOST

Grijač nudi pet temperaturnih nivoa u rasponu od 30°C do 60°C (moguće je promijeniti temperaturni raspon). Elektronski senzor u grijaču omogućuje njihovo precizno održavanje. Uređaj prikazuje trenutnu i podešenu temperaturu. Karakterizira ga vrlo niska potrošnja energije u stanju mirovanja.

Funkcija **SUŠENJA** omogućuje podešavanje bilo koje temperature u trajanju od dva sata nakon čega se grijač vraća u prethodno stanje.

### INTELIGENTNI SUSTAVI ZGRADA

U slučaju nestanka struje, grijač pamti zadanu vrijednost (unaprijed postavljenu), omogućujući suradnju s vanjskim tajmerima i inteligentnim sustavima zgrada.

### SIGURNOST

Grijač opremljen zaštitom od smrzavanja ANTIFREEZE koja sprječava pad temperature radijatora ispod 5-7 °C i dvostrukom zaštitom od prekomjernog porasta temperature radijatora. Signalizira stanje alarmom. Ima aktivnu zaštitu pri radu u suhom radijatoru.

- duljina kabela 2,5 m
- napajanje 230V / 50Hz



Š.Vokel	Opis
<b>1416018</b>	GRIJAČ MOA BIJELI 400W
<b>1416019</b>	GRIJAČ MOA BIJELI 600W
<b>1416020</b>	GRIJAČ MOA BIJELI 800W
<b>1416021</b>	GRIJAČ MOA BIJELI 1000W
<b>1416022</b>	GRIJAČ MOA BIJELI 1200W

Š.Vokel	Opis
<b>1416023</b>	GRIJAČ MOA KROM 400W
<b>1416024</b>	GRIJAČ MOA KROM 600W
<b>1416025</b>	GRIJAČ MOA KROM 800W
<b>1416026</b>	GRIJAČ MOA KROM 1000W
<b>1416027</b>	GRIJAČ MOA KROM 1200W

Š.Vokel	Opis
<b>1416028</b>	GRIJAČ MOA SIVI 400W
<b>1416029</b>	GRIJAČ MOA SIVI 600W
<b>1416030</b>	GRIJAČ MOA SIVI 800W
<b>1416031</b>	GRIJAČ MOA SIVI 1000W
<b>1416032</b>	GRIJAČ MOA SIVI 1200W

**Gun Metal | Gold | Silver | Black**



**Dvostruki profil** Bellavia tuš kabina pruža Premium kvalitetu, veću stabilnost i čvrstoću. Ravne linije profila prate estetske trendove i daju elegantan izgled. S kaljenim staklom koje je izuzetno otporno, pružamo kupcima sigurnost i udobnost.

U ponudi imamo tuš kabine, walk in stjenke, tuš vrata i paravane bijelih, silver, crnih, zlatnih i gun metal profila, u visinama od 185 do 200 cm, u kombinacijama prozirnog, zamagljenog mliječnog ili smokey stakla.



Vrata, stjenke i kabine posjeduju **svojstvo reverzibilnosti**, što znači da se po zahtjevima prostorije mogu okretati na lijevu ili na desnu stranu.



**“EASY CLEANING GLASS- STAKLO S NANO PREMAZOM”** poznato kao “staklo koje se samo čisti” odnosi se na staklenu površinu koja je presvučena posebnim premazom koji značajno sprječava zadržavanje prašine i kapljica vode što olakšava održavanje i čišćenje stakla.

**NANO  
PREMAZ**

## NOVO U PONUDI

**Kompenzacijski profil** - Ukoliko vam prostor za ugradnju tuš kabine nije standardnih dimenzija, u ponudi imamo i kompenzacijske profile koji nude produljenje do 2,58 CM po jednoj strani.

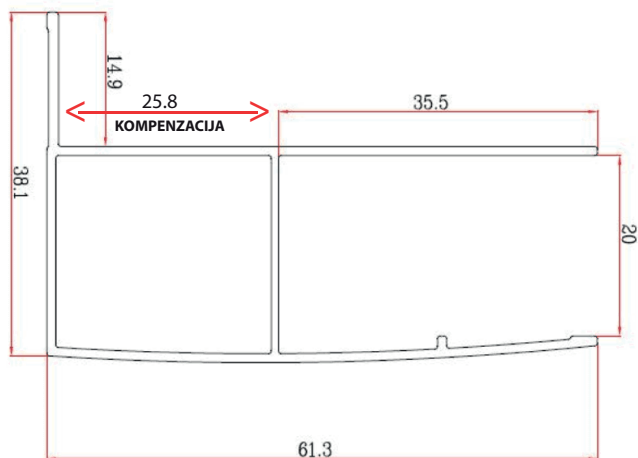

**Instalacija:** Postojeći profil se uklanja i mijenja kompenzacijskim.

ČETVRTASTA TUŠ KABINA 6Y1011-2-GM



GUN METAL PROFIL

H = 200

ŠIFRA VOKEL	DIMENZIJA	STAKLO	PROFIL	UGRADNA MJERA (cm)
<b>1113319</b>	90x90	PROZIRNO STAKLO 6mm	GUN METAL PROFIL	88-90

REZERVNI DIJELOVI

H = 200

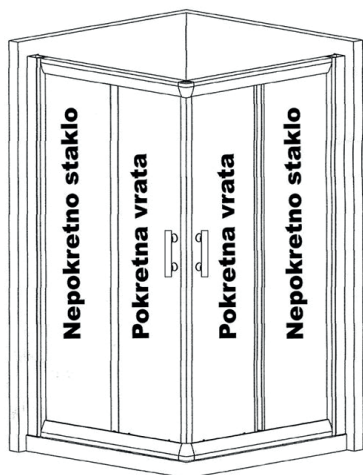

POKRETNNA VRATA

ŠIFRA VOKEL	STAKLO	ZA DIMENZIJU
<b>1113262</b>	PROZIRNO STAKLO	90x90

NEPOKRETNNO STAKLO

ŠIFRA VOKEL	STAKLO	ZA DIMENZIJU
<b>1113263</b>	PROZIRNO STAKLO	90x90

ŠIFRA VOKEL	OPIS	PAK/KOM
<b>1113270</b>	DIHTUNG S MAGNETOM ZA POKRETNNA VRATA	SET (2)
<b>1113275</b>	DIHTUNG IZMEĐU POKRETNIH I NEPOKRETNIH VRATA	SET (2)

	ŠIFRA VOKEL
TOČKIĆI - GORNJI	<b>1113346</b>
TOČKIĆI - DONJI	<b>1113347</b>

RUČKICA

	ŠIFRA VOKEL
S DVIJE RUPE	<b>1113348</b>



**ČETVRTASTA TUŠ KABINA 6Y1013CGM**



**GUN METAL PROFIL**

H = 200

ŠIFRA VOKEL	DIMENZIJA	STAKLO	PROFIL	UGRADNA MJERA (cm)
<b>1113320</b>	80x120	SMOKEY STAKLO 6 mm	GUN METAL	78-80/118-120
<b>1113321</b>	90x120	SMOKEY STAKLO 6 mm	PROFIL	88-90/118-120

**REZERVNI DIJELOVI**

H = 200

**POKRETNNA VRATA**

ŠIFRA VOKEL	STAKLO	ZA DIMENZIJU
<b>1113396</b>	SMOKEY STAKLO	80x120
<b>1113397</b>	SMOKEY STAKLO	90x120

**NEPOKRETNNO STAKLO**

ŠIFRA VOKEL	STAKLO	ZA DIMENZIJU
<b>1113398</b>	SMOKEY STAKLO	80x120
<b>1113399</b>	SMOKEY STAKLO	90x120

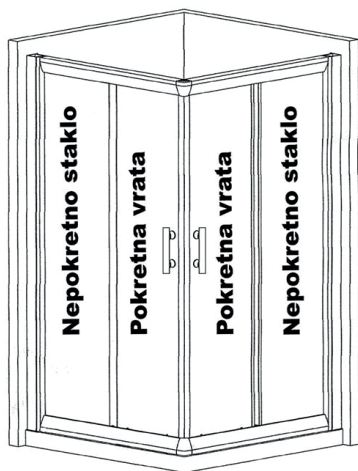

ŠIFRA VOKEL	OPIS	PAK/KOM
<b>1113270</b>	DIHTUNG S MAGNETOM ZA POKRETNNA VRATA	SET (2)
<b>1113275</b>	DIHTUNG IZMEĐU POKRETNIIH I NEPOKRETNIIH VRATA	SET (2)

	ŠIFRA VOKEL
TOČKIĆI - GORNJI	<b>1113346</b>
TOČKIĆI - DONJI	<b>1113347</b>

**RUČKICA**

	ŠIFRA VOKEL
S DVIJE RUPE	<b>1113348</b>

TUŠ VRATA 6740-2-GM



GUN METAL PROFIL

H = 200

ŠIFRA VOKEL	L	H	OPIS	PROFIL	UGRADNA MJERA (cm)
<b>1113318</b>	120	200	TUŠ VRATA PROZIRNO STAKLO	GUN METAL PROFIL	118-120

REZERVNI DIJELOVI

ŠIFRA VOKEL	OPIS
<b>1113349</b>	VRATA PROZIRNO STAKLO

	ŠIFRA VOKEL
TOČKIĆI - GORNJI	<b>1113367</b>
TOČKIĆI - DONJI	<b>1113368</b>

TUŠ STJENKA WALK IN



GUN METAL PROFIL

H = 200



TUŠ STJENKA 8W1002GM

ŠIFRA VOKEL	L	H	D	OPIS	PROFIL	UGRADNA MJERA (cm)
<b>1113322</b>	80	200	80-120	PROZIRNO STAKLO 8 mm	GUN METAL PROFIL	78,5-80
<b>1113323</b>	90			PROZIRNO STAKLO 8 mm		88,5-90
<b>1113324</b>	100			PROZIRNO STAKLO 8 mm		98,5-100
<b>1113325</b>	110			PROZIRNO STAKLO 8 mm		108,5-110
<b>1113326</b>	120			PROZIRNO STAKLO 8 mm		118,5-120

REZERVNI DIJELOVI

ŠIFRA VOKEL	OPIS
<b>1113350</b>	STABILIZATOR ZA WALK IN 8W1002-056 - GUN METAL, 80-120

TUŠ VRATA VENERA SILVER 6Y1150



SILVER PROFIL

H = 200

ŠIFRA VOKEL	L	H	OPIS	PROFIL	UGRADNA MJERA (cm)
<b>1113327</b>	120	200	PROZIRNO STAKLO 6 mm	SILVER PROFIL	117-120
<b>1113328</b>	140		PROZIRNO STAKLO 6 mm		137-140
<b>1113329</b>	160		PROZIRNO STAKLO 6 mm		157-160

TUŠ STJENKA VENERA 6D1042



SILVER PROFIL

H = 200

ZA VRATA 6Y1150

ŠIFRA VOKEL	L	H	OPIS	PROFIL	UGRADNA MJERA (cm)
<b>1113333</b>	80	200	PROZIRNO STAKLO 6 mm	SILVER PROFIL	78,5-80
<b>1113334</b>	90		PROZIRNO STAKLO 6 mm		88,5-90
<b>1113335</b>	100		PROZIRNO STAKLO 6 mm		98,5-100

REZERVNI DIJELOVI

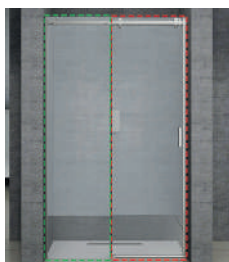

POKRETNNA VRATA

ŠIFRA VOKEL	OPIS	ZA DIMENZIJU
<b>1113361</b>	PROZIRNO STAKLO S NANO PREMAZOM	120
<b>1113362</b>		140
<b>1113363</b>		160

NEPOKRETNNO STAKLO

ŠIFRA VOKEL	OPIS	ZA DIMENZIJU
<b>1113364</b>	PROZIRNO STAKLO S NANO PREMAZOM	120
<b>1113365</b>		140
<b>1113366</b>		160

**REZERVNI DIJELOVI ZA VENERU**

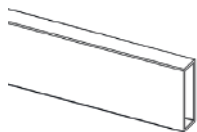

**VODILICA**

ŠIFRA VOKEL	ZA DIMENZIJU	OPIS
<b>1113353</b>	120	VODILICA ZA VENERU KROM
<b>1113390</b>	140	
<b>1113391</b>	160	



**DONJI DIHTUNG**

ŠIFRA VOKEL	ZA DIMENZIJU	OPIS
<b>1113355</b>	120	DONJI DIHTUNG NA VRATIMA
<b>1113392</b>	140	
<b>1113393</b>	160	



**ZAŠTITNA LAJSNA**

ŠIFRA VOKEL	ZA DIMENZIJU	OPIS
<b>1113381</b>	120	ZAŠTITNA LAJSNA
<b>1113394</b>	140	
<b>1113395</b>	160	



**DIHTUNG**

ŠIFRA VOKEL	OPIS
<b>1113356</b>	DIHTUNG IZMEĐU POKRETNIH I NEPOKRETNIH VRATA



**LEŽAJ**

ŠIFRA VOKEL	OPIS
<b>1113357</b>	LEŽAJ ZA TUŠ VRATA



**NOSAČ**

ŠIFRA VOKEL	OPIS
<b>1113373</b>	NOSAČ KLIZNE ŠIPKE



**MAGNET**

ŠIFRA VOKEL	OPIS
<b>1113375</b>	MAGNET NA VRATIMA



**MAGNET**

ŠIFRA VOKEL	OPIS
<b>1113377</b>	MAGNET U PROFILU

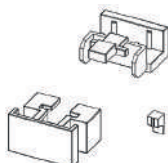

**DRŽAČ**

ŠIFRA VOKEL	OPIS
<b>1113379</b>	DRŽAČ LAJSNE

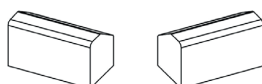

**DRŽAČ**

ŠIFRA VOKEL	OPIS
<b>1113383</b>	DRŽAČ STAKLA

TUŠ VRATA 6K1015A



SILVER PROFIL

H = 200

TUŠ VRATA 6K1015A

ŠIFRA VOKEL	L	H	OPIS	PROFIL	UGRADNA MJERA (cm)
<b>1113300</b>	80	200	OTVARANJE PREMA VAN, PROZIRNO STAKLO 6 mm	SILVER PROFIL	76-78
<b>1113301</b>	90		OTVARANJE PREMA VAN, PROZIRNO STAKLO 6 mm		86-88
<b>1113302</b>	100		OTVARANJE PREMA VAN, PROZIRNO STAKLO 6 mm		96-98

TUŠ VRATA 6K1015A



CRNI PROFIL

H = 200

TUŠ VRATA 6K1015A

ŠIFRA VOKEL	L	H	OPIS	PROFIL	UGRADNA MJERA (cm)
<b>1113297</b>	80	200	OTVARANJE PREMA VAN, PROZIRNO STAKLO 6 mm	CRNI PROFIL	76-78
<b>1113298</b>	90		OTVARANJE PREMA VAN, PROZIRNO STAKLO 6 mm		86-88
<b>1113299</b>	100		OTVARANJE PREMA VAN, PROZIRNO STAKLO 6 mm		96-98

**TUŠ VRATA VENERA BLACK 6Y1150B**



**BLACK PROFIL**

H = 200

ŠIFRA VOKEL	L	H	OPIS	PROFIL	UGRADNA MJERA (cm)
<b>1113330</b>	120	200	PROZIRNO STAKLO 6 mm	BLACK PROFIL	117-120
<b>1113331</b>	140		PROZIRNO STAKLO 6 mm		137-140
<b>1113332</b>	160		PROZIRNO STAKLO 6 mm		157-160

**TUŠ STJENKA VENERA 6D1042B**



**BLACK PROFIL**

H = 200

**ZA VRATA 6Y1150B**

ŠIFRA VOKEL	L	H	OPIS	PROFIL	UGRADNA MJERA (cm)
<b>1113336</b>	80	200	PROZIRNO STAKLO 6 mm	BLACK PROFIL	78,5-80
<b>1113337</b>	90		PROZIRNO STAKLO 6 mm		88,5-90
<b>1113338</b>	100		PROZIRNO STAKLO 6 mm		98,5-100

**REZERVNI DIJELOVI**

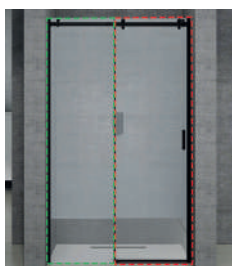

**POKRETNNA VRATA**

ŠIFRA VOKEL	OPIS	ZA DIMENZIJU
<b>1113361</b>	PROZIRNO STAKLO S NANO PREMAZOM	120
<b>1113362</b>		140
<b>1113363</b>		160

**NEPOKRETNNO STAKLO**

ŠIFRA VOKEL	OPIS	ZA DIMENZIJU
<b>1113364</b>	PROZIRNO STAKLO S NANO PREMAZOM	120
<b>1113365</b>		140
<b>1113366</b>		160



**REZERVNI DIJELOVI ZA VENERA BLACK**

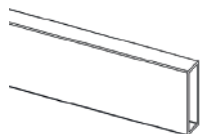

**VODILICA**

ŠIFRA VOKEL	ZA DIMENZIJU	OPIS
<b>1113354</b>	120	VODILICA ZA VENERU BLACK
<b>1113384</b>	140	
<b>1113385</b>	160	



**DONJI DIHTUNG**

ŠIFRA VOKEL	ZA DIMENZIJU	OPIS
<b>1113360</b>	120	DONJI DIHTUNG NA VRATIMA VENERA BLACK
<b>1113386</b>	140	
<b>1113387</b>	160	



**ZAŠTITNA LAJSNA**

ŠIFRA VOKEL	ZA DIMENZIJU	OPIS
<b>1113380</b>	120	ZAŠTITNA LAJSNA BLACK
<b>1113388</b>	140	
<b>1113389</b>	160	

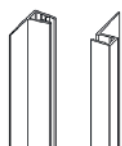

**DIHTUNG**

ŠIFRA VOKEL	OPIS
<b>1113359</b>	DIHTUNG IZMEĐU POKRETNIH I NEPOKRETNIH VRATA VENERA BLACK



**LEŽAJ**

ŠIFRA VOKEL	OPIS
<b>1113358</b>	LEŽAJ ZA TUŠ VRATA VENERA BLACK



**NOSAČ**

ŠIFRA VOKEL	OPIS
<b>1113372</b>	NOSAČ KLIZNE ŠIPKE BLACK



**MAGNET**

ŠIFRA VOKEL	OPIS
<b>1113374</b>	MAGNET NA VRATIMA BLACK



**MAGNET**

ŠIFRA VOKEL	OPIS
<b>1113376</b>	MAGNET U PROFILU BLACK

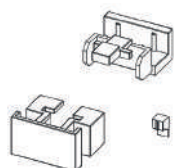

**DRŽAČ**

ŠIFRA VOKEL	OPIS
<b>1113378</b>	DRŽAČ LAJSNE BLACK

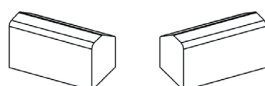

**DRŽAČ**

ŠIFRA VOKEL	OPIS
<b>1113382</b>	DRŽAČ STAKLA L/D BLACK

## Tuš kada BELLA



Bijela akrilna tuš kada sa oblogom izrađena od 100% lijevanog sanitarnog akrila (PMMA), podnožje kade ojačano drvenom pločom te poliesterskom smolom i staklenim platnom.

Garancija kvalitete i trajnosti 10 godina.

Šifra Vokel	Opis	ART.
<b>1181001</b>	TUŠ KADA 90x90 BELLA S OBLOGOM, POLUKRUŽNA	00733
<b>1181002</b>	TUŠ KADA 80x80 BELLA S OBLOGOM, POLUKRUŽNA	00734

**Dužina :** 0.8 m - 0.9 m

**Širina :** 0.8 m - 0.9 m

**Visina :** 0.195 m

**Dubina :** 0.08 m

**Oblik :** kutna polukružna

## Tuš kada QUADRO



Bijela akrilna tuš kada sa oblogom izrađena od 100% lijevanog sanitarnog akrila (PMMA), podnožje kade ojačano drvenom pločom te poliesterskom smolom i staklenim platnom.

Garancija kvalitete i trajnosti 10 godina.

Šifra Vokel	Opis	ART.
<b>1181003</b>	TUŠ KADA 90x90 QUADRO S OBLOGOM, ČETVRTASTA	00729
<b>1181004</b>	TUŠ KADA 80x80 BELLA S OBLOGOM, ČETVRTASTA	00730

**Dužina :** 0.8 m - 0.9 m

**Širina :** 0.8 m - 0.9 m

**Visina :** 0.195 m

**Dubina :** 0.07 m

**Oblik :** kvadratna

## PERFECT WATER PRESSURE

### FINALLY COMPACT AND EASY TO INSTALL



Š.Vokel	Opis
0633059	UREĐAJ ZA POVIŠENJE TLAKA SCALA2 3-45 ART.98562862

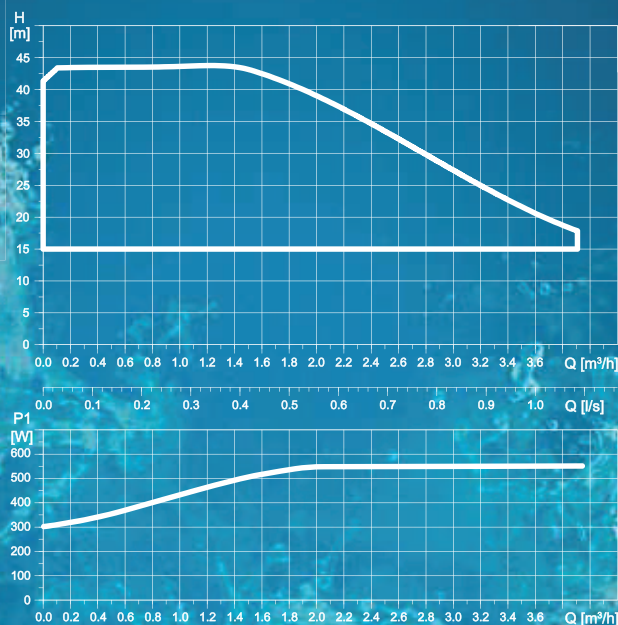

#### Idealan tlak u kućanstvu uz SCALA2 – jednostavna i lagana za montažu

SCALA2 je mala crpka za kućanstvo koja osigurava idealan tlak u svim slavinama - čak i kada je istovremeno otvoreno nekoliko slavina i tuš. Sastoji se od crpke, motora, spremnika i nepovratnog ventila i sve to u jednoj maloj kompaktnoj jedinici koja se lako i brzo montira. Pametna crpka SCALA2 prilagođava svoj rad svim zahtjevima uz najnižu razinu buke u svojoj klasi.

#### Što je to inteligentni nadzor crpke?

SCALA2 ima ugrađen senzor koji konstantno mjeri izlazni tlak. Ukoliko tlak padne ispod određene razine, SCALA2 pojačava djelovanje odmah, kako bi nadoknadila gubitak tlaka u sustavu. Mi to nazivamo inteligentni nadzor rada crpke i rezultat toga je idealan tlak vode u domaćinstvu.

#### Prednosti

- Idealan tlak : Inteligentni nadzor rada crpke prilagođava rad i tako osigurava idealan tlak tijekom cijelog vremena
- Niska buka: S razinom buke od samo (47 dB(A)) SCALA2 je najtiši uređaj u svojoj klasi
- Jednostavan odabir: Jedna varijanta za sve primjene u kućanstvima
- Lagana montaža: Kompaktno i sve u jednom rješenje za savršenu montažu u svim prilikama.
- Jednostavno rukovanje: Prijateljsko sučelje uz jednostavne postavke
- Pouzdan rad: Zaštita od rada na suho, zaštita od učestalog uključivanja
- Dugi vijek trajanja: Kvaliteta testirana do savršenstva, niski troškovi održavanja

#### Primjene

SCALA2 je namijenjena svim objektima visine do 3 kata i do ukupno 8 slavina.

- Gradski vodovod: Povišenje tlaka vode iz mreže gradskog vodovoda
- Spremnici: Povišenje tlaka vode iz krovnih spremnika, podzemnih spremnika, uključujući i spremnike kišnice.
- Bunari: Crpljenje vode iz bunara do dubine 8 metara

## ALPHA1 L

UNIVERZALNA CIRKULACIONA CRPKA

**ALPHA1 L** odgovara većini postojećih instalacija gdje su već bile ugrađene Grundfos crpke, zahvaljujući kompaktnom dizajnu, priključcima za signalne kablove (PWM) i boljem podnošenju visokih temperatura. To znači da se lako može zamjeniti pokvarena ili ne učinkovita crpka bez dodatnog ulaganja vremena i novca.



### Prednosti:

- Kompatibilna je s većinom postojećih instalacija s Grundfos crpkama
- Manja potreba za rezervnim dijelovima
- Mijenja kompletnu crpku ili samo glavu crpke
- Priključak za signalne kablove (PWM)
- Izdržljiva konstrukcija i visokokvalitetni materijali

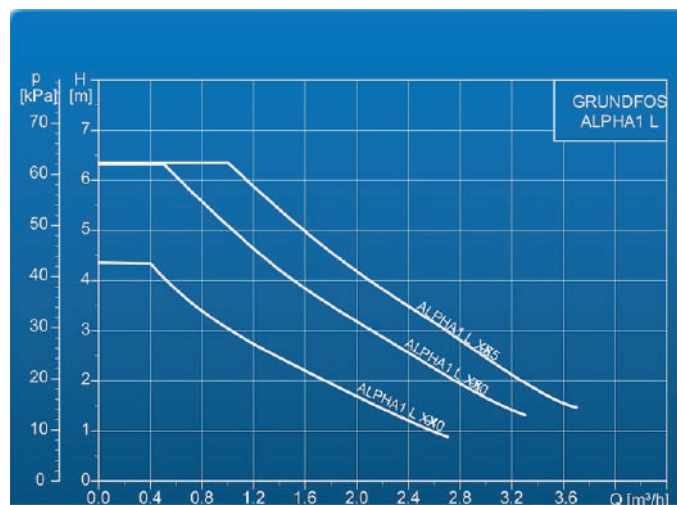

### Tehničke karakteristike:

Klasa izolacije:	IP42
Razina buke:	43 dB (A)
Temperaturni razred:	TF110
Potrošnja energije:	4-60 W
Volumen protoka, Q :	3,8 m /h
Visina dizanja, H <sub>max</sub> :	6,5 m
EEL (razred energetske učinkovitosti)	< 0,23
Temperatura tekućine:	+2°C... + 110°C
Temperatura okoline:	0°C... +55°C

### Prednosti:

- Tri konstantne krivulje / konstantne brzine
- Prikladna za radijatorsko grijanje
- Prikladna za podno grijanje
- PWM priključak za signalne kablove
- Vijak za deblokadu
- Niski index energetske učinkovitosti (EEL)
- Niski troškovi održavanja
- Niska razina buke
- Vrlo jednostavna montaža

ŠIFRA VOKEL	OPIS	ŠIFRA ARTIKLA
<b>0633060</b>	CIRKULACIONA PUMPA ALPHA1 L 25-40	99160579
<b>0633061</b>	CIRKULACIONA PUMPA ALPHA1 L 25-60	99160584
<b>0633062</b>	CIRKULACIONA PUMPA ALPHA1 L 32-60	99160590

**CIRKULACIONE PUMPE IMP SAN**

	<p><b>0695012</b></p>	<p>CIRKULACIONA PUMPA IMP SAN 20/40</p>	<p>ART.979521766</p>
	<p><b>0695021</b></p>	<p>CIRKULACIONA PUMPA IMP SAN 20/60</p>	<p>ART.979521769</p>
	<p><b>0695023</b></p>	<p>CIRKULACIONA PUMPA IMP SAN 20/70</p>	<p>ART.979522018</p>





# PATIO

PLINSKA GRIJALICA ZA TERASE  
CRNA BOJA



ŠIFRA VOKEL

OPIS

**1446035**

**TERASNA PLINSKA GRIJALICA CRNE BOJE 8,2 kW  
art.PATIO/M/G30/30MBAR/CZ**



# PATIO

PLINSKA GRIJALICA ZA TERASE  
BIJELA BOJA

kratki

Vokel



ŠIFRA VOKEL

OPIS

1446036

TERASNA PLINSKA GRIJALICA BIJELE BOJE 8,2 kW  
art.PATIO/M/G30/30MBAR/B

### WIKTOR/PF

UGRADNI GUSANI KAMIN NA DRVA



≥ 900 cm<sup>2</sup>  
≥ 700 cm<sup>2</sup>

- snaga - 14
- težina - 124
- promjer - Ø 200
- dužina drveta - 450 mm
- učinkovitost - 70%
- raspon snage - 7-18
- temperatura plinova - 352

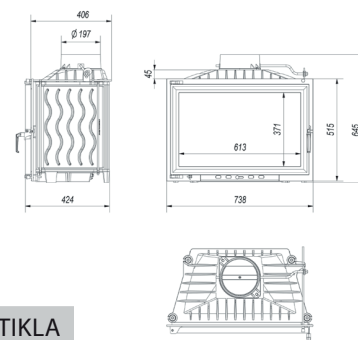

ŠIFRA VOKEL	BOJA	SNAGA	ŠIFRA ARTIKLA
1446001	CRNA	14 kW	WIKTOR/PF

### ZUZIA/L/BS

UGRADNI GUSANI KAMIN NA DRVA - LIJEVO BOČNO STAKLO



≥ 1000 cm<sup>2</sup>  
≥ 800 cm<sup>2</sup>

- snaga - 16
- težina - 183
- promjer - Ø 200
- dužina drveta - 500 mm
- učinkovitost - 76%
- raspon snage - 7,5-21
- temperatura plinova - 355

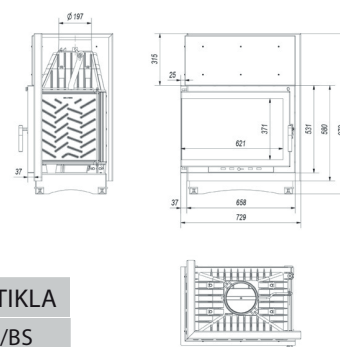

ŠIFRA VOKEL	BOJA	SNAGA	ŠIFRA ARTIKLA
1446002	CRNA	16 kW	ZUZIA/L/BS

### ZUZIA/P/BS

UGRADNI GUSANI KAMIN NA DRVA - DESNO BOČNO STAKLO



≥ 1000 cm<sup>2</sup>  
≥ 800 cm<sup>2</sup>

- snaga - 16
- težina - 183
- promjer - Ø 200
- dužina drveta - 500 mm
- učinkovitost - 76%
- raspon snage - 7,5-21
- temperatura plinova - 355

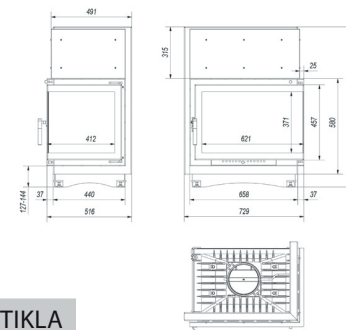

ŠIFRA VOKEL	BOJA	SNAGA	ŠIFRA ARTIKLA
1446003	CRNA	16 kW	ZUZIA/P/BS

### OLIWIA/G

UGRADNI GUSANI KAMIN NA DRVA



≥ 1000 cm<sup>2</sup>  
≥ 800 cm<sup>2</sup>

- snaga - 18
- težina - 244
- promjer - Ø 200
- dužina drveta - 500 mm
- učinkovitost - 79%
- raspon snage - 9-23
- temperatura plinova - 383

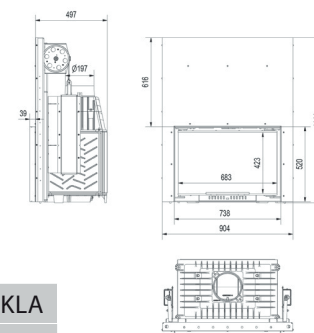

ŠIFRA VOKEL	BOJA	SNAGA	ŠIFRA ARTIKLA
1446034	CRNA	18 kW	OLIWIA/G



**KASETA/ARKE/80**

UGRADNI ČELIČNI KAMIN NA DRVA S INTEGRIRANIM VENTILATOROM

 ≥ 900 cm<sup>2</sup>  
 ≥ 700 cm<sup>2</sup>

- snaga - 12
- težina - 132
- promjer - Ø 200
- dužina drveta - 350 mm
- učinkovitost - 75%
- raspon snage - 6-16
- temperatura plinova - 320

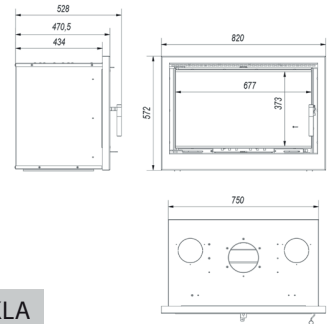

ŠIFRA VOKEL	BOJA	SNAGA	ŠIFRA ARTIKLA
1446004	CRNA	12 kW	KASETA/ARKE/80

**MAJA/L/BS/DECO**

UGRADNI GUSANI KAMIN NA DRVA - LIJEVO BOČNO STAKLO

 ≥ 700 cm<sup>2</sup>  
 ≥ 500 cm<sup>2</sup>

- snaga - 8
- težina - 139
- promjer - Ø 200
- dužina drveta - 330 mm
- učinkovitost - 80%
- raspon snage - 3-10
- temperatura plinova - 238

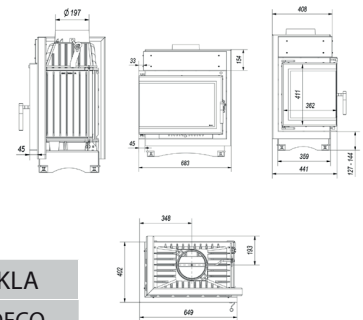

ŠIFRA VOKEL	BOJA	SNAGA	ŠIFRA ARTIKLA
<b>1446039</b>	CRNA	8 kW	MAJA/L/BS/DECO

**MAJA/P/BS/DECO**

UGRADNI GUSANI KAMIN NA DRVA - DESNO BOČNO STAKLO

 ≥ 700 cm<sup>2</sup>  
 ≥ 500 cm<sup>2</sup>

- snaga - 8
- težina - 139
- promjer - Ø 200
- dužina drveta - 330 mm
- učinkovitost - 80%
- raspon snage - 3-10
- temperatura plinova - 238

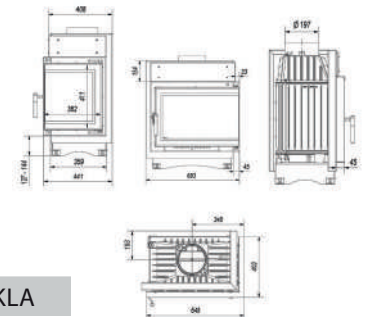

ŠIFRA VOKEL	BOJA	SNAGA	ŠIFRA ARTIKLA
<b>1446040</b>	CRNA	8 kW	MAJA/P/BS/DECO

**NBC/800/400**

UGRADNI ČELIČNI KAMIN NA DRVA

 ≥ 700 cm<sup>2</sup>  
 ≥ 500 cm<sup>2</sup>

- snaga - 10
- težina - 275
- promjer - Ø 200
- dužina drveta - 300 mm
- učinkovitost - 83%
- raspon snage - 5-13
- temperatura plinova - 191

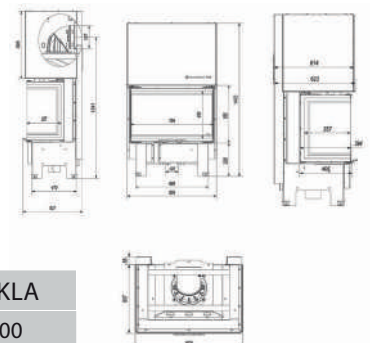

ŠIFRA VOKEL	BOJA	SNAGA	ŠIFRA ARTIKLA
<b>1446043</b>	CRNA	10 kW	NBC/800/400

## MB120/G

UGRADNI KAMIN NA DRVA



≥ 1000 cm<sup>2</sup>  
≥ 800 cm<sup>2</sup>

- snaga - 20
- težina - 396
- promjer - Ø 200
- dužina drveta - 500 mm
- učinkovitost - 80%
- raspon snage - 10-27
- temperatura plinova - 240

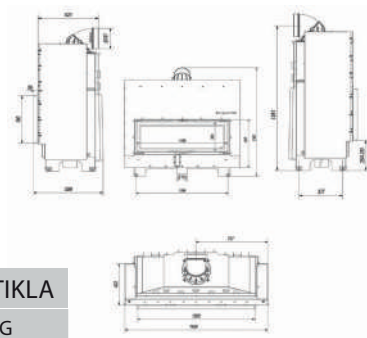

ŠIFRA VOKEL	BOJA	SNAGA	ŠIFRA ARTIKLA
<b>1446044</b>	CRNA	20 kW	MB120/G

## KAMIN WK 440

KALIJEVA PEĆ NA DRVA



- snaga - 6,5
- težina - 130
- promjer - Ø 130
- dužina drveta - 350 mm
- učinkovitost - 80%
- raspon snage - 3-9,3
- temperatura plinova - 327

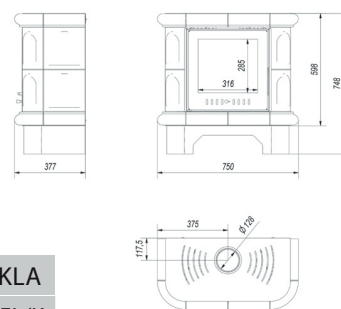

ŠIFRA VOKEL	BOJA	SNAGA	ŠIFRA ARTIKLA
<b>1446006</b>	BIJELA	6,5 kW	WK/440/KAFEL/K

## KAMIN KOZA/AB/S/N/DR/KAF/CZER

KAMIN NA DRVA



- snaga - 8
- težina - 106
- promjer - Ø 150
- dužina drveta - 250 mm
- učinkovitost - 78%
- raspon snage - 5,5-10,5
- temperatura plinova - 265

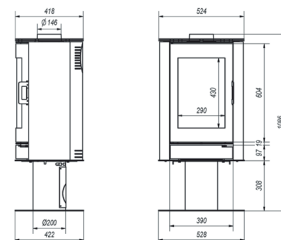

ŠIFRA VOKEL	BOJA	SNAGA	ŠIFRA ARTIKLA
<b>1446042</b>	CRVENA	8 kW	KOZA/AB/S/N/KAFEL/ CZERWONY



## KAMIN/KOZA/AB/S/DR

KAMIN NA DRVA



- snaga - 8
- težina - 110
- promjer - Ø 150
- dužina drveta - 250 mm
- učinkovitost - 78%
- raspon snage - 5,5-10,5
- temperatura plinova - 265

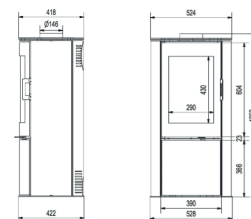

ŠIFRA VOKEL	BOJA	SNAGA	ŠIFRA ARTIKLA
<b>1446021</b>	CRVENA	8 kW	KOZA/AB/S/DR/KAFEL/ CZERWONY



**KAMIN KOZA/AB/S/DR**

KAMIN NA DRVA



- snaga - 8
- promjer - Ø 150
- učinkovitost - 78%
- temperatura plinova - 265
- težina - 110
- dužina drveta - 250 mm
- raspon snage - 5,5-10,5

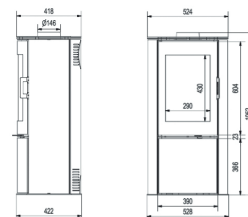

ŠIFRA VOKEL	BOJA	SNAGA	ŠIFRA ARTIKLA
<b>1446011</b>	CRNA	8 kW	KOZA/AB/S/DR/KAFEL/CZARNY

**KAMIN/KOZA/AB/S/N/DR/KAF/CZARNY**

KAMIN NA DRVA



- snaga - 8
- promjer - Ø 150
- učinkovitost - 78%
- temperatura plinova - 265
- težina - 110
- dužina drveta - 250 mm
- raspon snage - 5,5-10,5



ŠIFRA VOKEL	BOJA	SNAGA	ŠIFRA ARTIKLA
<b>1446042</b>	CRNA	8 kW	KOZA/AB/S/N/DR/KAFEL/CZARNY

**KAMIN KOZA/K5/S/W**

KAMIN NA DRVA



- snaga - 7
- promjer - Ø 150
- učinkovitost - 76%
- temperatura plinova - 250
- težina - 1225
- dužina drveta - 250 mm
- raspon snage - 5,5-9

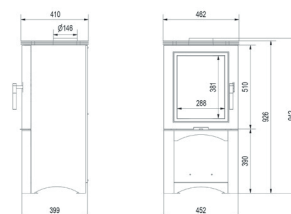

ŠIFRA VOKEL	BOJA	SNAGA	ŠIFRA ARTIKLA
<b>1446012</b>	CRNA	7 kW	KOZA/K5/S/W

**KAMIN KOZA/K7**

GUSANI KAMIN NA DRVA



- snaga - 5
- promjer - Ø 130
- učinkovitost - 71%
- temperatura plinova - 340
- težina - 75
- dužina drveta - 300 mm
- raspon snage - 3-8

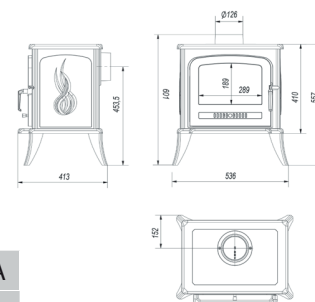

ŠIFRA VOKEL	BOJA	SNAGA	ŠIFRA ARTIKLA
<b>1446008</b>	CRNA	5 kW	KOZA/K7

KAMIN KOZA/K8

GUSANI KAMIN NA DRVA



- snaga - 9
- težina - 127
- promjer - Ø 130
- dužina drveta - 350 mm
- učinkovitost - 75%
- raspon snage - 5-11
- temperatura plinova - 385

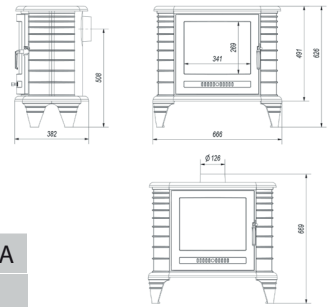

ŠIFRA VOKEL	BOJA	SNAGA	ŠIFRA ARTIKLA
<b>1446009</b>	CRNA	9 kW	KOZA/K8

KAMIN KOZA/K10

GUSANI KAMIN NA DRVA



- snaga - 10
- težina - 109
- promjer - Ø 130
- dužina drveta - 350 mm
- učinkovitost - 75%
- raspon snage - 6-13
- temperatura plinova - 334

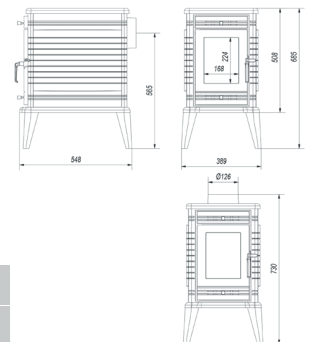

ŠIFRA VOKEL	BOJA	SNAGA	ŠIFRA ARTIKLA
<b>1446010</b>	CRNA	10 kW	KOZA/K10

THOR/VIEW8

KAMIN NA DRVA



- snaga - 8
- težina - 140
- promjer - Ø 150
- raspon snage - 5,5-10
- učinkovitost - 83%
- temperatura plinova - 175

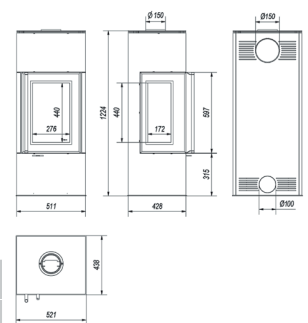

ŠIFRA VOKEL	BOJA	SNAGA	ŠIFRA ARTIKLA
<b>1446037</b>	CRNA	8 kW	THORE/VIEW8

THOR8

KAMIN NA DRVA



- snaga - 8
- težina - 160
- promjer - Ø 150
- raspon snage - 5,5-10
- učinkovitost - 83%
- temperatura plinova - 175

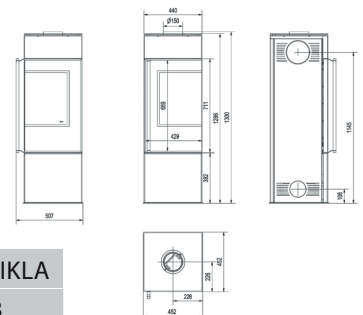

ŠIFRA VOKEL	BOJA	SNAGA	ŠIFRA ARTIKLA
<b>1446038</b>	CRNA	8 kW	THOR8



**ZUZIA/G**

UGRADNI KAMIN NA DRVA



- snaga - 16
- težina - 225
- promjer - Ø 200
- dužina drveta - 500 mm
- učinkovitost - 76%
- raspon snage - 7,5 - 21
- temperatura plinova - 355

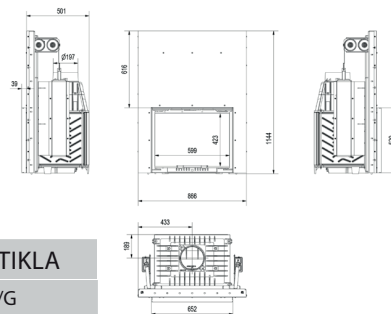

ŠIFRA VOKEL	BOJA	SNAGA	ŠIFRA ARTIKLA
<b>1446071</b>	CRNA	16 kW	ZUZIA/G

**ZUZIA/P/BS/G**

UGRADNI KAMIN NA DRVA



- snaga - 16
- težina - 243
- promjer - Ø 200
- dužina drveta - 500 mm
- učinkovitost - 76%
- raspon snage - 7,5 - 21
- temperatura plinova - 355

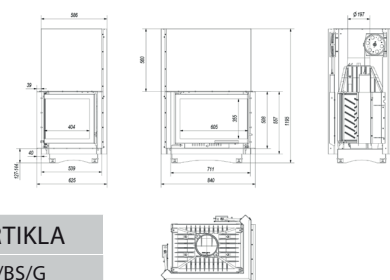

ŠIFRA VOKEL	BOJA	SNAGA	ŠIFRA ARTIKLA
<b>1446072</b>	CRNA	16 kW	ZUZIA/P/BS/G

**ZUZIA/L/BS/G**

UGRADNI KAMIN NA DRVA



- snaga - 16
- težina - 243
- promjer - Ø 200
- dužina drveta - 500 mm
- učinkovitost - 76%
- raspon snage - 7,5 - 21
- temperatura plinova - 355

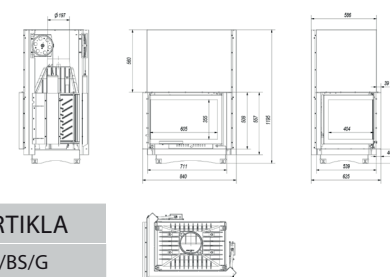

ŠIFRA VOKEL	BOJA	SNAGA	ŠIFRA ARTIKLA
<b>1446073</b>	CRNA	16 kW	ZUZIA/L/BS/G

**MILA/PW/24/G/W**

UGRADNI ČELIČI KAMIN NA DRVA ZA CENTRALNO GRIJANJE



≥ 900 cm<sup>2</sup>  
≥ 700 cm<sup>2</sup>

- snaga vode - 12
- težina - 312
- promjer - Ø 200
- kapacitet vode - 52 l
- učinkovitost - 78%
- raspon snage - 11-30
- temperatura plinova - 305
- radni tlak - 2

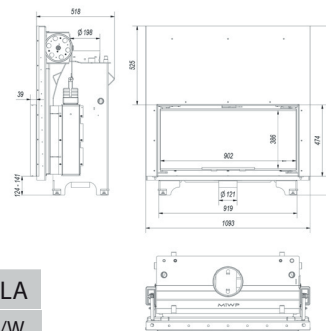



ŠIFRA VOKEL	BOJA	SNAGA	ŠIFRA ARTIKLA
<b>1446005</b>	CRNA	24 kW	MILA/PW/24/G/W

## ZUZIA/PW/19/W/DECO

UGRADNI KAMIN NA DRVA ZA CENTRALNO GRIJANJE



 snaga vode - 15

 promjer - Ø 200

 učinkovitost - 75%

 radni tlak - 2

 temperatura plinova - 295

 težina - 199

 kapacitet vode - 40,5 l

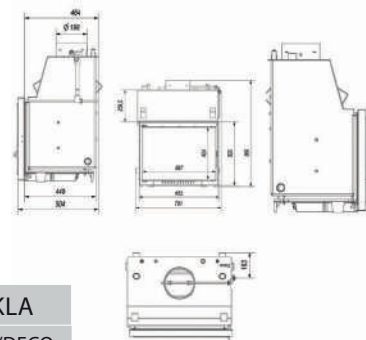
 raspon snage - 10-24

ŠIFRA VOKEL	BOJA	SNAGA	ŠIFRA ARTIKLA
<b>1446060</b>	CRNA	19 kW	ZUZIA/PW/19/W/DECO

**NOVEMBER**

BIO KAMIN NA BIOETANOL

 težina - 52

 materijal

 1,2

ŠIFRA VOKEL	BOJA	DIMENZIJE [cm]	ŠIFRA ARTIKLA
<b>1446019</b>	BIJELA	115x29,5x101,3	NOVEMBER

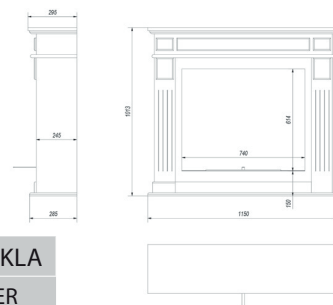
**OSCAR**

BIO KAMIN NA BIOETANOL

 težina - 25

 materijal

 1,2

ŠIFRA VOKEL	BOJA	DIMENZIJE [cm]	ŠIFRA ARTIKLA
<b>1446018</b>	CRNA	90x19,5x63	OSCAR/CZARNY

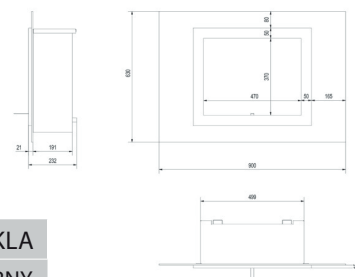
**PLANET**

BIO KAMIN NA BIOETANOL

 težina - 81

 materijal

 1,6

ŠIFRA VOKEL	BOJA	DIMENZIJE [cm]	ŠIFRA ARTIKLA
<b>1446020</b>	BIJELA	81x33,1x97,5	PLANET

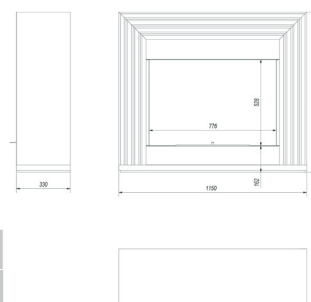
**HOTEL**

BIO KAMIN NA BIOETANOL

 težina - 15,5

 materijal

 1,2

ŠIFRA VOKEL	BOJA	DIMENZIJE [cm]	ŠIFRA ARTIKLA
1446014	CRNA	70x33,4x40	HOTEL

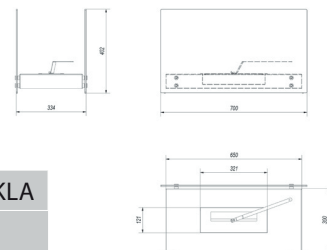

## HOTEL MINI

BIO KAMIN NA BIOETANOL



težina - 6

materijal

0,4

ŠIFRA VOKEL	BOJA	DIMENZIJE [cm]	ŠIFRA ARTIKLA
1446013	CRNA	39x23,4x25	HOTEL/MINI

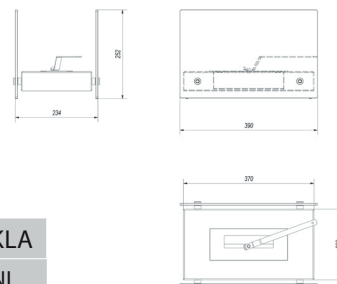

## INDIA MINI

BIO KAMIN NA BIOETANOL



težina - 4

materijal

1,2

ŠIFRA VOKEL	BOJA	DIMENZIJE [cm]	ŠIFRA ARTIKLA
1446015	CRNA	34x15,5x7	INDIA/MINI

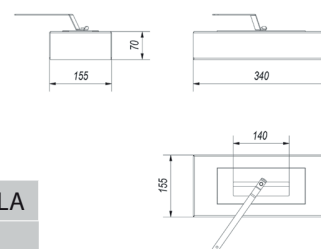

## TANGO 1

BIO KAMIN NA BIOETANOL



težina - 3,5

materijal

0,44

ŠIFRA VOKEL	BOJA	DIMENZIJE [cm]	ŠIFRA ARTIKLA
1446016	CRNA	20x20x38	TANGO 1

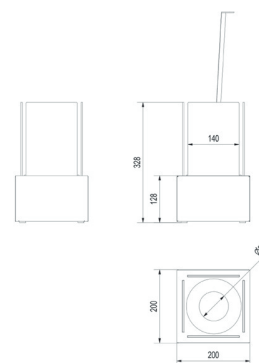

## ROMEO

BIO KAMIN NA BIOETANOL



težina - 19

materijal

1,2

ŠIFRA VOKEL	BOJA	DIMENZIJE [cm]	ŠIFRA ARTIKLA
1446017	CRNA	35,9x20,9x113,55	ROMEO



### OKRUGLA REŠETKA

Ø 125



ŠIFRA VOKEL	BOJA	DIMENZIJE [mm]	ŠIFRA ARTIKLA
1446022	BIJELA	Ø125	FI/125B

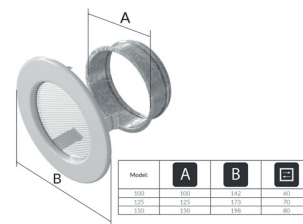

### ČETVRTASTA REŠETKA SA MOGUĆNOŠĆU ZATVARANJA

17 x 17 cm

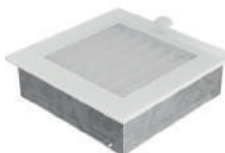

ŠIFRA VOKEL	BOJA	DIMENZIJE [cm]	ŠIFRA ARTIKLA
1446025	BIJELA	17x17	17BX

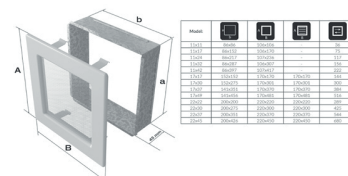

### PRAVOKUTNA REŠETKA SA MOGUĆNOŠĆU ZATVARANJA

17 x 30 cm



ŠIFRA VOKEL	BOJA	DIMENZIJE [cm]	ŠIFRA ARTIKLA
1446026	BIJELA	17x30	30BX

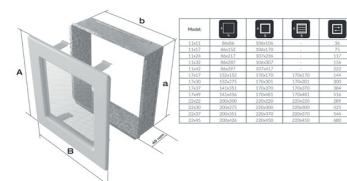

### ČETVRTASTA REŠETKA SA MOGUĆNOŠĆU ZATVARANJA

17 x 17 cm



ŠIFRA VOKEL	BOJA	DIMENZIJE [cm]	ŠIFRA ARTIKLA
1446023	GRAFIT	17x17	17GX

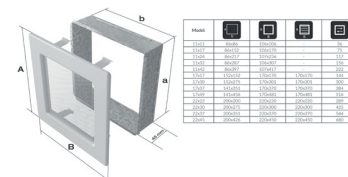

### PRAVOKUTNA REŠETKA SA MOGUĆNOŠĆU ZATVARANJA

17 x 30 cm

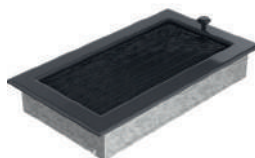

ŠIFRA VOKEL	BOJA	DIMENZIJE [cm]	ŠIFRA ARTIKLA
1446024	GRAFIT	17x30	30GX

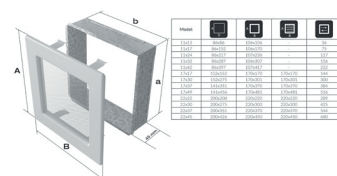

### ČETVRTASTA REŠETKA OSCAR SA MOGUĆNOŠĆU ZATVARANJA

17x17



ŠIFRA VOKEL	BOJA	DIMENZIJE [mm]	ŠIFRA ARTIKLA
1446027	BIJELA	17x17	17OBX

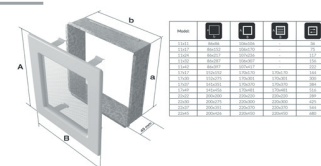

### PRAVOKUTNA REŠETKA OSCAR SA MOGUĆNOŠĆU ZATVARANJA

17 x 30 cm

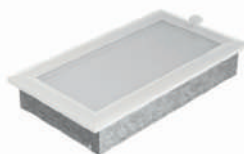

ŠIFRA VOKEL	BOJA	DIMENZIJE [cm]	ŠIFRA ARTIKLA
1446028	BIJELA	17x30	30OBX



RAVNA VENTILACIJSKA KANALICA

LUFT



ŠIFRA VOKEL	BOJA	DIMENZIJE [cm]	ŠIFRA ARTIKLA
1446030	BIJELA	6x60	LUFT/6/60/45S/B
1446053	CRNA	6x60	LUFT/6/60/45S/C
1446055	BIJELA	9x60	LUFT/9/60/45S/B
1446057	CRNA	9x60	LUFT/9/60/45S/C



Model	X	Y
LUFT/6/20/45S/B	300	51
LUFT/6/40/45S/B	400	111
LUFT/6/60/45S/B	600	171
LUFT/6/80/45S/B	800	231
LUFT/6/100/45S/B	1000	291

RAVNA VENTILACIJSKA KANALICA

LUFT



ŠIFRA VOKEL	BOJA	DIMENZIJE [cm]	ŠIFRA ARTIKLA
1446029	BIJELA	6 x 80	LUFT/6/80/45S/B
1446054	CRNA	6 x 80	LUFT/6/80/45S/C
1446056	BIJELA	9 x 80	LUFT/9/80/45S/B
1446058	CRNA	9 x 80	LUFT/9/80/45S/C



Model	X	Y
LUFT/6/80/45S/B	800	111
LUFT/6/100/45S/B	1000	171
LUFT/9/80/45S/B	800	231
LUFT/9/100/45S/B	1000	291

KUTNA VENTILACIJSKA KANALICA

LUFT



ŠIFRA VOKEL	BOJA	DIMENZIJE [cm]	ŠIFRA ARTIKLA
1446032	BIJELA	76,6 x 54,7 x 6	LUFT/NL/60/45S/B
1446047	BIJELA	54,7 x 76,6 x 9	LUFT/NP/90/45S/B
1446033	BIJELA	54,7 x 76,6 x 6	LUFT/NP/60/45S/B
1446048	BIJELA	76,6 x 54,7 x 9	LUFT/NL/90/45S/B

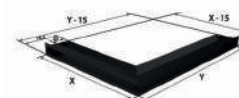

Model	X	Y	Z
LUFT/NL/60/45S/B	540	540	260
LUFT/NP/90/45S/B	766	547	336
LUFT/NP/60/45S/B	547	766	336
LUFT/NL/90/45S/B	600	600	330

KUTNA VENTILACIJSKA KANALICA

LUFT



ŠIFRA VOKEL	BOJA	DIMENZIJE [cm]	ŠIFRA ARTIKLA
1446052	CRNA	76,6 x 54,7 x 6	LUFT/NL/60/45S/C
1446049	CRNA	54,7 x 76,6 x 9	LUFT/NP/90/45S/C
1446051	CRNA	74,7 x 76,6 x 6	LUFT/NP/60/45S/C
1446050	CRNA	76,6 x 54,7 x 9	LUFT/NL/90/45S/C

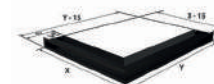

Model	X	Y	Z
LUFT/NL/60/45S/C	540	540	261
LUFT/NP/90/45S/C	766	547	336
LUFT/NP/60/45S/C	547	766	336
LUFT/NL/90/45S/C	600	600	334

CIJEV S KLAPNOM

ZA REGULACIJU DOVODA ZRAKA Ø 125



ŠIFRA VOKEL	DIMENZIJE [mm]	ŠIFRA ARTIKLA
1446031	Ø125	P125/R



**CIJEV S KLAPNOM**

ZA REGULACIJU DOVODA ZRAKA Ø 125 : Ø 100

ŠIFRA VOKEL	DIMENZIJE [Ø]	ŠIFRA ARTIKLA
<b>1446068</b>	100	P100
<b>1446059</b>	125	P125

**DOLOT/KROCIEC**

PRIKLJUČAK ZA VANJSKI DOVOD ZRAKA

ŠIFRA VOKEL	ŠIFRA ARTIKLA
<b>1446045</b>	DOLOT/KROCIEC

**PDR90**

CIJEVNI ADAPTER

ŠIFRA VOKEL	DIMENZIJE [mm]	ŠIFRA ARTIKLA
<b>1446064</b>	25x152 (Ø100)	PDR90/100
<b>1446065</b>	25x152 (Ø125)	PDR90/125

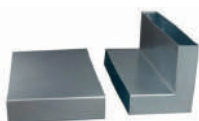
**DOLOT/PRZEJSCIE**

DOVOD ZRAKA - KUTNI 90 ° ILI 360 °

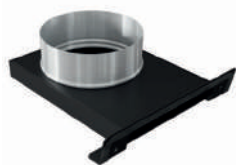

ŠIFRA VOKEL	PRIJELAZ OD ULAZA [°]	ŠIFRA ARTIKLA
<b>1446066</b>	90 °	DOLOT/PRZEJSCIE/90
<b>1446067</b>	360 °	DOLOT/PRZEJSCIE/360

**DOLOT/ZELIWO**

PRIKLJUČAK ZA VANJSKI DOVOD ZRAKA Ø100 ili Ø125

ŠIFRA VOKEL	DIMENZIJE [Ø]	ŠIFRA ARTIKLA
<b>1446069</b>	100	DOLOT/ZELIWO/100
<b>1446070</b>	125	DOLOT/ZELIWO/125

**RED/S/200/180**

DIMOVODNA REDUKCIJA Ø200/180

ŠIFRA VOKEL	VELIČINA [Ø]	ŠIFRA ARTIKLA
<b>1446063</b>	200/180	RED/S/200/180



TASMA/170 - TASMA350

JEDNOSTRANA LJEPLJIVA ALU TRAKA

ŠIFRA VOKEL	BOJA	OTPORNOST [do °C]	ŠIFRA ARTIKLA
<b>1446061</b>	SREBRNA	170 °C	TASMA/170
<b>1446062</b>	SREBRENA	350 °C	TASMA/350



PLYN/PIANKA

SRETSTVO ZA ČIŠĆENJE STAKLA

ŠIFRA VOKEL	BOJA	DIMENZIJE [ml]	ŠIFRA ARTIKLA
1446041	-	500	PLYN/PIANKA



SENZUR/W/P/K/6x3

UŽE ZA STAKLO NA KAMINU S LJEPLJIVOM TRAKOM 1m

ŠIFRA VOKEL	DIMENZIJE [mm]	ŠIFRA ARTIKLA
<b>1446046</b>	6X3	SENZUR/W/P/K/6X3

**ZUZIA/G**

UGRADNI KAMIN NA DRVA



- snaga - 16
- težina - 225
- promjer - Ø 200
- dužina drveta - 500 mm
- učinkovitost - 76%
- raspon snage - 7,5 - 21
- temperatura plinova - 355

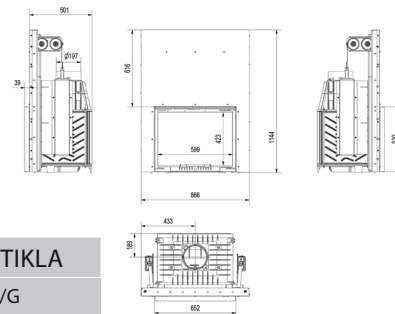

ŠIFRA VOKEL	BOJA	SNAGA	ŠIFRA ARTIKLA
<b>1446071</b>	CRNA	16 kW	ZUZIA/G

**ZUZIA/P/BS/G**

UGRADNI KAMIN NA DRVA



- snaga - 16
- težina - 243
- promjer - Ø 200
- dužina drveta - 500 mm
- učinkovitost - 76%
- raspon snage - 7,5 - 21
- temperatura plinova - 355

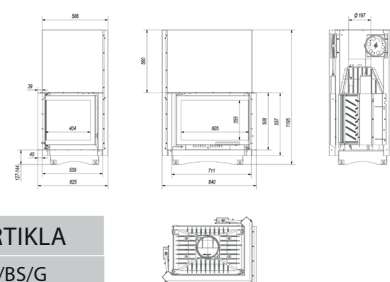

ŠIFRA VOKEL	BOJA	SNAGA	ŠIFRA ARTIKLA
<b>1446072</b>	CRNA	16 kW	ZUZIA/P/BS/G

**ZUZIA/L/BS/G**

UGRADNI KAMIN NA DRVA



- snaga - 16
- težina - 243
- promjer - Ø 200
- dužina drveta - 500 mm
- učinkovitost - 76%
- raspon snage - 7,5 - 21
- temperatura plinova - 355

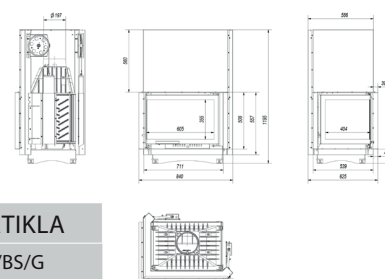

ŠIFRA VOKEL	BOJA	SNAGA	ŠIFRA ARTIKLA
<b>1446073</b>	CRNA	16 kW	ZUZIA/L/BS/G

## Fashion



## FASHION 80, 100 cm - BOJA DRVETA

ŠIFRA VOKEL	OPIS	Art.
<b>0466503</b>	KUPAONSKI NAMJEŠTAJ FASHION 80 [06271-OGLEDALO 80x68 ALL, 10281-ORMARIĆ BASE 2 LADICE 79x45x54, 10503-KERAMIČKI UMIVAONIK 81x46, 13500-LAMPA LED 5W SMART]	10631
<b>0466506</b>	KUPAONSKI NAMJEŠTAJ FASHION 100 [02295-OGLEDALO 95x68 ALL, 10284-ORMARIĆ BASE 2 LADICE 99x45x54, 10505-KERAMIČKI UMIVAONIK 101x46, 13500-LAMPA LED 5W]	10633
<b>0466509</b>	ORMARIĆ FASHION 25x18x100	10554
<b>0466511</b>	ORMARIĆ I-STYLE S VRATIMA 34x34x13	13073
<b>0466512</b>	ORMARIĆ I-STYLE GIORNO 34x34x13, REVERZIBILNI	13071
<b>0466516</b>	STUB FASHION 34x162x25, REVERZIBILNI, 1 VRATA	13825
<b>0466519</b>	STUB FASHION 34x25x162, REVERZIBILNI, 2 VRATA	13827

## Fashion



## FASHION 80, 100 cm - BOJA CEMENTO

ŠIFRA VOKEL	OPIS	Art.
<b>0466504</b>	KUPAONSKI NAMJEŠTAJ FASHION 80 [06271-OGLEDALO 80x68 ALL, 10281-ORMARIĆ BASE 2 LADICE 79x45x54, 10503-KERAMIČKI UMIVAONIK 81x46, 13500-LAMPA LED 5W SMART]	10632
<b>0466507</b>	KUPAONSKI NAMJEŠTAJ FASHION 100 [02295-OGLEDALO 95x68 ALL, 10284-ORMARIĆ BASE 2 LADICE 99x45x54, 10505-KERAMIČKI UMIVAONIK 101x46, 13500-LAMPA LED 5W SMART]	10634
<b>0466510</b>	ORMARIĆ FASHION 25x100, CEMENTO	10555
<b>0466513</b>	ORMARIĆ I-STYLE GIORNO 34x34x13, CEMENTO , REVERZIBILNI	13072
<b>0466514</b>	ORMARIĆ I-STYLE S VRATIMA 34x34x13, CEMENTO, REVERZIBILNI	13074
<b>0466517</b>	STUB FASHION 34x162x25, REVERZIBILNI, 1 VRATA, CEMENTO	13826
<b>0466520</b>	STUB FASHION 34x25x162, REVERZIBILNI, 2 VRATA, CEMENTO	13748

## Fashion



## FASHION 80, 100 cm - BIJELO

ŠIFRA VOKEL	OPIS	Art.
<b>0466502</b>	KUPAONSKI NAMJEŠTAJ FASHION 80 [06271-OGLEDALO 80x68 ALL, 10281-ORMARIĆ BASE 2 LADICE 79x45x54, 10503-KERAMIČKI UMIVAONIK 81x46, 13500-LAMPA LED 5W SMART]	10630
<b>0466505</b>	KUPAONSKI NAMJEŠTAJ FASHION 100 [11206-OGLEDALO 95x68 ALL, 10283-ORMARIĆ BASE 2 LADICE 99x45x54, 10505-KERAMIČKI UMIVAONIK 101x46, 13500-LAMPA LED 5W SMART]	10639
<b>0466508</b>	ORMARIĆ FASHION 25x18x100	10378
<b>0466515</b>	STUB FASHION BIJELO 34x162x25, REVERZIBILNI, 1 VRATA	13750
<b>0466518</b>	STUB FASHION BIJELO 32x25x162, REVERZIBILNI 2 VRATA	13753
<b>0466419</b>	ORMARIĆ I-STYLE GIORNO 34x34x13, BIJELO	07168
<b>0466421</b>	ORMARIĆ I-STYLE S VRATIMA 34x34x13, BIJELO	07171



## Athena



ATHENA 03 80 cm - BIANCO

ŠIFRA VOKEL	OPIS	Art.
<b>0466531</b>	KUPAONSKI NAMJEŠTAJ ATHENA 03 80 cm - BIANCO SASTAVLJEN OD: BAZA ATHENA CM 80 1/C 99474 TOP ISDH BIANCO MARMO 81x46	13874
<b>0466532</b>	STUB ATHENA BIANCO REVERZIBILNI 34x162x25	13878

## Athena



ATHENA 04 120 cm - BIANCO

ŠIFRA VOKEL	OPIS	Art.
<b>0466533</b>	NAMJEŠTAJ ATHENA 120 BIANCO SASTAVLJENO OD : 13492 BAZA ATHENA CM 1201/C 99476 TOP ISDH BIANCO MARMO 121x46	13875
<b>0466532</b>	STUB ATHENA BIANCO REVERZIBILNI 34x162x25	13878

## Athena



## ATHENA 04 80 cm - BEIGE/GRIGIO

ŠIFRA VOKEL	OPIS	Art.
<b>0466534</b>	NAMJEŠTAJ ATHENA 04 80CM, BEIGE/GRIGIO RAL 1019 SASTAVLJENO OD : 13493 BAZA ATHENA CM 80 1/C RAL 1019 99451 TOP ISDH NERO 81x46x1,2	13876
<b>0466536</b>	STUB ATHENA RAL 1019, 1/A REVERZIBILNI 34x162	13880

## Athena



## ATHENA 04 120 cm - BEIGE/GRIGIO

ŠIFRA VOKEL	OPIS	Art.
<b>0466535</b>	NAMJEŠTAJ ATHENA 120 BEIGE GRIGIO RAL1019 SASTAVLJENO OD : 13494 BAZA ATHENA CM 120 1/C RAL 1019 99543 TOP ISDH NERO 121x46x1,2	13877
<b>0466536</b>	STUB ATHENA RAL 1019 1/A REVERZIBILNI 34x162	13880

## Athena



### ATHENA 01 80 cm - VERDE/BLUE

ŠIFRA VOKEL	OPIS	Art.
<b>0466529</b>	KUPAONSKI NAMJEŠTAJ ATHENA 01 80 cm - BOJA VERDE BLU (PLAVO/ZELENA) RAL 6004, SASTAVLJEN OD: 13491 BAZA ATHENA CM 80 1/C-RAL6004 13501 UMIVAONIK DOMUS	13873
<b>0466530</b>	ORMARIĆ ATHENA 25x100 BOJA VERDE BLU (PLAVO/ZELENA), ral 6004, REVERZIBILNI 25x18x100	10559

## Mary



### MARY 01 105 cm - TELEGRIGIO

ŠIFRA VOKEL	OPIS	Art.
<b>0466537</b>	KUPAONSKI NAMJEŠTAJ MARY 01 105 cm RAL 7046, SASTAVLJENO OD 05185 BAZA MARY 74x45 2/C RAL 7046, 10614 BOČNA BAZA A GIORNO ISDH 30x45 NERO, 99462 TOP ISHD NERO 105x46x1,2	05186
<b>0466538</b>	STUP ATHENA RAL 7046, REVERZIBILNI 1/A 34x162 TELEGRIGIO	13881

## Modula



## MODULA 110 cm - NODATO CEMENTO

ŠIFRA VOKEL	OPIS	Art.
<b>0466539</b>	KUPAONSKI NAMJEŠTAJ MODULA 110/1 ROVERE NODATO CEMENTO, 110x40x46	12432
<b>0466509</b>	ORMARIĆ FASHION BOJA DRVETA - REVERE NODATO, REVERZIBILNI	10554
<b>0466510</b>	ORMARIĆ FASHION, BOJA CEMENTO REVERZIBILNI 25x18x100	10555
<b>0466511</b>	ORMARIĆ I-STYLE S VRATIMA, BOJA DRVETA - ROVERE NODATO (HRAST) REVERZIBILNI 34x34x13	13073
<b>0466512</b>	ORMARIĆ I-STYLE GIORNO, BOJA DRVETA - ROVERE NODATO (HRAST) REVERZIBILNI 34x34x13	13071
<b>0466513</b>	ORMARIĆ I-STYLE GIORNO, BOJA CEMENTO REVERZIBILNI, 34x34x13	13072
<b>0466514</b>	ORMARIĆ I-STYLE S VRATIMA, BOJA CEMENTO REVERZIBILNI 34x34x13	13074
<b>0466516</b>	STUB FASHION, BOJA DRVETA ROVERE NODATO (HRAST) REVERZIBILNI 1 VRATA, 34x162x25	13825
<b>0466517</b>	STUB FASHION, BOJA CEMENTO REVERZIBILNI 1 VRATA 34x162x25	13826
<b>0466519</b>	STUB FASHION, BOJA DRVETA - ROVERE NODATO (HRAST) REVERZIBILNI 2 VRATA 34x25x162	13827
<b>0466520</b>	STUB FASHION, BOJA CEMENTO REVERZIBILNI 2 VRATA 34x25x162	13748



Šifra Vokel	Opis	Dimenzije	Art.
<b>0466522</b>	OGLEDALO OMEGA LED SVJETLO 5W, 105x90 cm	105x90	13705
<b>0466523</b>	OGLEDALO OMEGA LED SVJETLO 5W, 80x90 cm	80x90	13704



Šifra Vokel	Opis	Art.
<b>0466524</b>	OGLEDALO OMICRON LED SVJETLO 28W	13707



**WOMAN**  
LED, CRNI OKVIR

Šifra Vokel	Opis	Dimenzije	Art.
<b>0466525</b>	OGLEDALO WOMAN LED SVJETLO 28W	80x65	13762
<b>0466526</b>	OGLEDALO WOMAN LED SVJETLO 32W	100x65	13765
<b>0466527</b>	OGLEDALO WOMAN LED SVJETLO 36W	120x65	13768
<b>0466528</b>	OGLEDALO WOMAN LED SVJETLO 40W	140x65	13771



Katalog proizvoda



**Ivana**

**60-190**

**60-130**

**60-190 1L**

**60-130 1L**

**40-190**

**30-190 SK**

**40-190 1L**

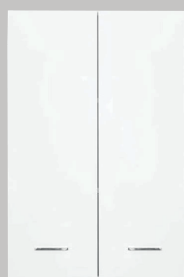
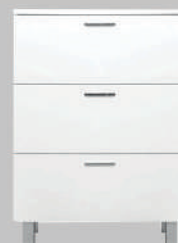
**40-130**

**60-90 S**

**60-85 3L**

**SHELF RIVA 50  
SHELF RIVA 60  
KLO FA LED 80 S**
**IVANA**

ŠIFRA VOKEL	OPIS	Art.
<b>1107046</b>	KUPAONSKI ORMAR IVANA 60-190	2069
<b>1107047</b>	KUPAONSKI ORMAR IVANA 60-130	2076
<b>1107048</b>	KUPAONSKI ORMAR IVANA 40-190	2090
<b>1107080</b>	KUPAONSKI ORMAR IVANA 40-130	2106
<b>1107112</b>	KUPAONSKI ORMAR IVANA 33-190 SK	1003783
<b>1107113</b>	KUPAONSKI ORMAR IVANA 60-90 S	1091704
<b>1107114</b>	KUPAONSKI ORMAR IVANA 60-85 3L	1091506
<b>1107115</b>	KUPAONSKI ORMAR IVANA 40-190 1L	1091605
<b>1107116</b>	KUPAONSKI ORMAR IVANA 60-130 1L	1091681
<b>1107117</b>	KUPAONSKI ORMAR IVANA 60-190 1L	1091988
<b>1107136</b>	KUPAONSKI ORMAR S OGLEDALOM SHELF RIVA 50	427143
<b>1107134</b>	KUPAONSKI ORMAR S OGLEDALOM SHELF RIVA 60	427150
<b>1107111</b>	KUPAONSKI ORMAR S OGLEDALOM KLO FA LED 80 S	427174

Luxury



LUXURY RIVA SCK 80



LUXURY DROP 80 S



LUXURY 40/170 S

LUXURY 80 cm

ŠIFRA VOKEL	OPIS	Art.
<b>1107087</b>	ORMARIĆ S OGLEDALOM LUXURY RIVA SCK 80 BIJELO VISOKI SJAJ	428515
<b>1107118</b>	KUPAONSKI ORMAR LUXURY DROP 80 S BLOCK, BIJELO VISOKI SJAJ	1081842
<b>1107088</b>	KUPAONSKI ORMAR SA STRANE LUXURY 40/170 S, BIJELO VISOKI SJAJ	427501

Albatros



VIVA 55  
VIVA 65  
VIVA 75  
VIVA 85



SHELF RIVA 50  
SHELF RIVA 60  
KLO FA LED 80 S

ili



ALBATROS 55



ALBATROS 65



ALBATROS 80

ALBATROS 55, 65, 80 cm

ŠIFRA VOKEL	OPIS	Art.
<b>1107106</b>	KUPAONSKI ORMAR S OGLEDALOM VIVA 55	421738
<b>1107103</b>	KUPAONSKI ORMAR ALBATROS 55 BLOK	1092725
<b>1107107</b>	KUPAONSKI ORMAR S OGLEDALOM VIVA 65	421745
<b>1107104</b>	KUPAONSKI ORMAR ALBATROS 65 BLOK	1092732
<b>1107135</b>	KUPAONSKI ORMAR S OGLEDALOM VIVA 75	421752
<b>1107108</b>	KUPAONSKI ORMAR S OGLEDALOM VIVA 85	421769
<b>1107105</b>	KUPAONSKI ORMAR ALBATROS 80 BLOK	1092749

**Absolute**

**ABSOLUTE 80/37**
**ABSOLUTE 60/37, 80/37 cm**

ŠIFRA VOKEL	OPIS	Art.
<b>1107119</b>	KUPAONSKI ORMAR ABSOLUTE 60/37 S BLOK	1082375
<b>1107120</b>	KUPAONSKI ORMAR ABSOLUTE 80/37 S BLOK	1082252

**SNOW**

**LUXURY 40/170**

**SNOW 78/2 DRAW**

**SNOW 60/2 DRAW**
**SNOW 60/2, 78/2 cm**

ŠIFRA VOKEL	OPIS	Art.
<b>1107121</b>	KUPAONSKI ORMAR SNOW 60/2 DRAW S PLOČOM S/SYNCHRO	1091018
<b>1107122</b>	KUPAONSKI ORMAR SNOW 78/2 DRAW S PLOČOM S/SYNCHRO	1090974
<b>1107123</b>	KUPAONSKI ORMAR LUXURY 40/170 SYNCHRO	1086649

**KIARA**



OGLEDALO KIARA 80

KIARA 80cm

ŠIFRA VOKEL

OPIS

Art.

**1107127**

KUPAONSKI ORMAR S OGLEDALOM KIARA 80 S, BIJELO VISOKI SJAJ

1077234

**SOFT GAP**

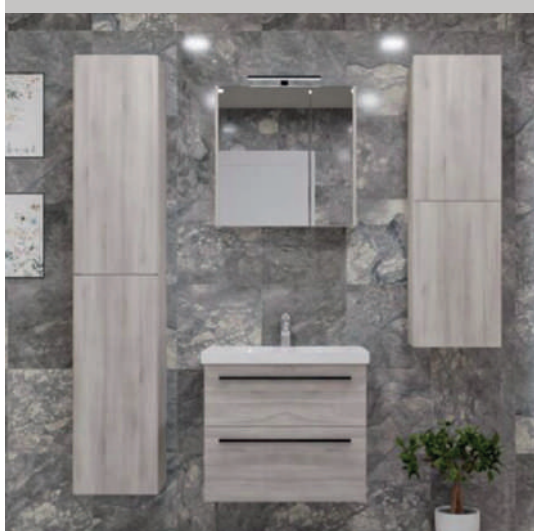

KIARA 65 KRONBERG



SOFT GAP 65 KRONBERG

KIARA 65 - SOFT 65,80 cm

ŠIFRA VOKEL

OPIS

Art.

**1107125**

KUPAONSKI ORMAR S OGLEDALOM KIARA 65, KRONBERG

1077265

**1107124**

KUPAONSKI ORMAR SOFT GAP 65 BLOK, KRONBERG

1074943

**SOFT GAP**

KIARA 65 - SOFT 65,80 cm

ŠIFRA VOKEL	OPIS	Art.
<b>1107126</b>	KUPAONSKI ORMAR SOFT GAP 80 BLOK, WHITE	1074967
<b>1107138</b>	KUPAONSKI ORMAR SOFT GAP 65 S BLOK	1074936
<b>1107139</b>	KUPAONSKI ORMAR SA OGLEDALOM KIARA 30-180	1077227
<b>1107140</b>	KUPAONSKI ORMARIĆ GAMMA-KIARA 30-180	1077326

**DROP**

LUXURY DROP 80, 78/2, 60/2 cm

ŠIFRA VOKEL	OPIS	Art.
<b>1107128</b>	KUPAONSKI ORMAR DROP 60/2 S PLOČOM CRNO/HALIFAX	1071133
<b>1107129</b>	KUPAONSKI ORMAR DROP 78/2 S PLOČOM CRNO/HALIFAX	1071140
<b>1107130</b>	KUPAONSKI ORMAR DROP 80, CRNO S BIJELIM UMIVAONIKOM	1081859
<b>1107137</b>	KUPAONSKI ORMAR LUXURY 40/170 CRNO MAT	1083129





### Elegant 80 cm

**FRONTE:** troslojno oplemenjeni iveral

**KORPUS:** troslojno oplemenjeni iveral

**DEKOR:** hrast authentic

**UMIVAONIK:** nadgradni

**BOJE:**



HRAST AUTHENTIC



BIJELI SJAJ

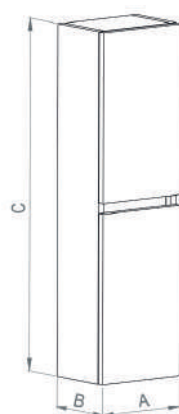

A=25, B=18,5, C=100

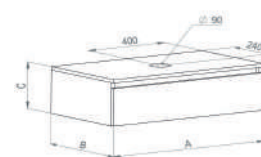

A=80, B=45, C=25



A=80, B=45, C=25

#### NAMJEŠTAJ ELEGANT 80 HRAST AUTHENTIC

ŠIFRA VOKEL	OPIS
1707011	Elegant 80 ormar gornji, hrast authentic
1707012	Elegant 80 ormar donji, hrast authentic
1707003	Elegant ormar bočni, hrast authentic
1707013	Ogledalo Tiffany 60x80



### Elegant 80 cm

**FRONTE:** MDF obložen PVC folijom

**KORPUS:** MDF obložen PVC folijom

**DEKOR:** bijeli sjaj

**UMIVAONIK:** nadgradni

**BOJE:**



HRAST AUTHENTIC



BIJELI SJAJ

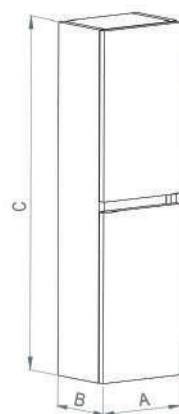

A=25, B=18,5, C=100

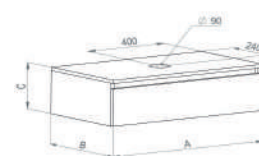

A=80, B=45, C=25

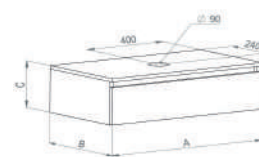

A=80, B=45, C=25

#### NAMJEŠTAJ ELEGANT 80 BIJELI SJAJ

ŠIFRA VOKEL	OPIS
1707022	Elegant 80 gornji ormarić, bijeli sjaj
1707023	Elegant 80 donji ormarić, bijeli sjaj
1707024	Elegant ormar bočni, bijeli sjaj
1707034	Ogledalo Lynn led 60x80





### Iva 80 cm

**FRONTE:** MDF obložen PVC folijom

**KORPUS:** MDF obložen PVC folijom

**UMIVAONIK:** keramički umivaonik

**GORNJI DIO OGLEDALO:** s policom

**RASVJETA:** led rasvjeta

**BOJE:**

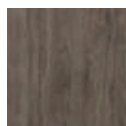

DARKWOOD



BIJELI SJAJ

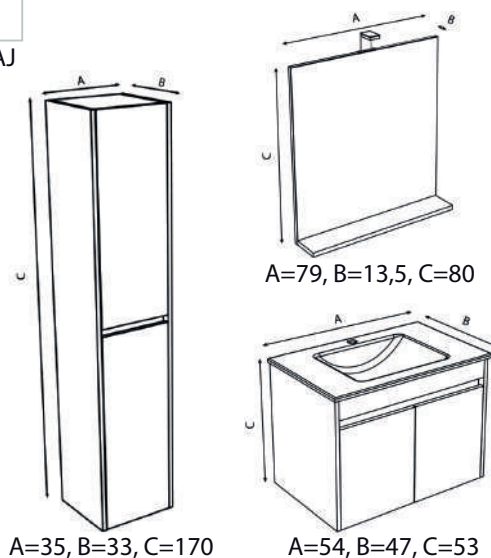

#### NAMJEŠTAJ IVA 80 BIJELI SJAJ

ŠIFRA VOKEL	OPIS
1707084	Ogledalo Iva 80 (led rasvjeta), bijeli sjaj
1707083	Ormar donji Iva 80, bijeli sjaj
1707066	Ormar bočni Iva 170, bijeli sjaj



### Iva 70 cm

**FRONTE:** MDF obložen PVC folijom

**KORPUS:** MDF obložen PVC folijom

**UMIVAONIK:** keramički umivaonik

**GORNJI DIO OGLEDALO:** s policom

**RASVJETA:** led rasvjeta

**BOJE:**



DARKWOOD



BIJELI SJAJ

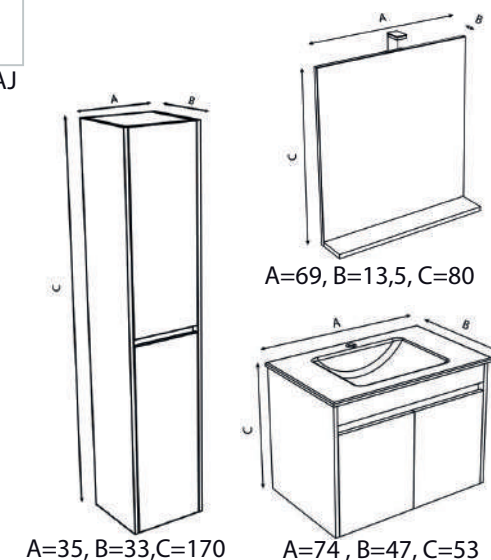

#### NAMJEŠTAJ IVA 70 BIJELI SJAJ

ŠIFRA VOKEL	OPIS
1707080	Ogledalo Iva 70 (led rasvjeta), bijeli sjaj
1707079	Ormar donji Iva 70, bijeli sjaj
1707066	Ormar bočni Iva 170, bijeli sjaj



### Iva 60 cm

**FRONTE:** MDF obložen PVC folijom

**KORPUS:** MDF obložen PVC folijom

**UMIVAONIK:** keramički umivaonik

**GORNJI DIO OGLEDALO:** s policom

**RASVJETA:** led rasvjeta

**BOJE:**



DARKWOOD BIJELI SJAJ

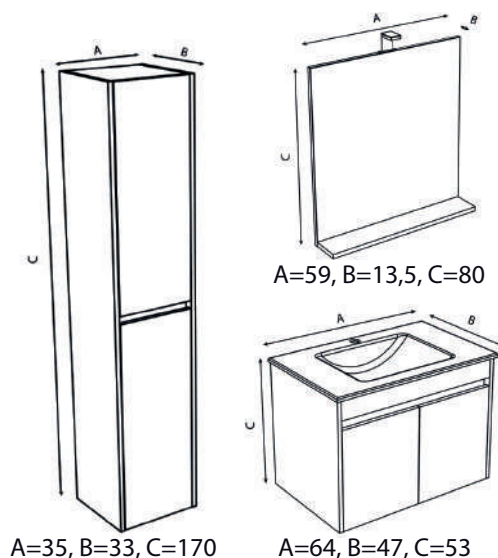

#### NAMJEŠTAJ IVA 60 BIJELI SJAJ

ŠIFRA VOKEL	OPIS
1707065	Ogledalo Iva 60 (led rasvjeta), bijeli sjaj
1707064	Ormar donji Iva 60, bijeli sjaj
1707066	Ormar bočni Iva 170, bijeli sjaj



### Iva 50 cm

**FRONTE:** MDF obložen PVC folijom

**KORPUS:** MDF obložen PVC folijom

**UMIVAONIK:** keramički umivaonik

**GORNJI DIO OGLEDALO:** s policom

**RASVJETA:** led rasvjeta

**BOJE:**



DARKWOOD BIJELI SJAJ

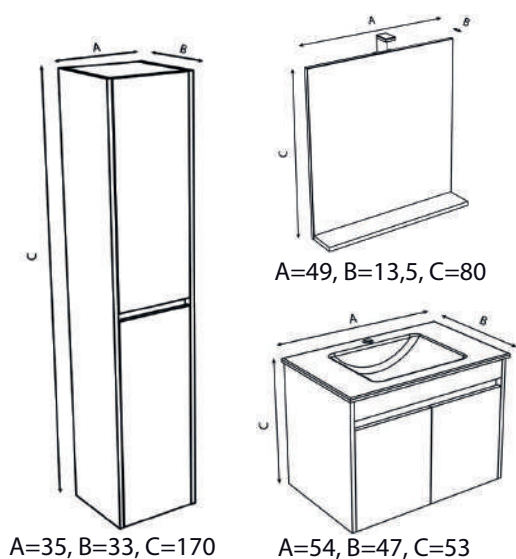

#### NAMJEŠTAJ IVA 50 BIJELI SJAJ

ŠIFRA VOKEL	OPIS
1707089	Ogledalo Iva 50 (led rasvjeta), bijeli sjaj
1707088	Ormar donji Iva 50, bijeli sjaj
1707066	Ormar bočni Iva 170, bijeli sjaj



## Ploča za umivaonik Atlas

**KORPUS:** troslojno oplemenjeni iveral

**GORNJA PLOČA:** troslojno oplemenjeni iveral

**RUČICE:** metal bijela ili antracit

**UMIVAONIK:** nadgradni

**OGLEDALO:** ploča od troslojno oplemenjenog iverala s ogledalom

**BOJE:**

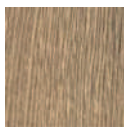

HRASST HALIFAX

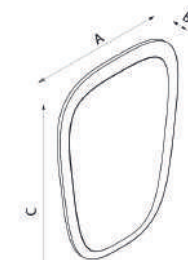

A=64, B=2, C=90

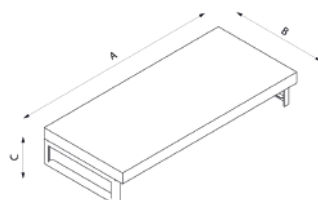

A=80, B=45, C=18

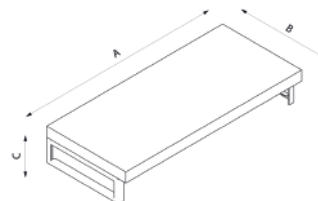

A=100, B=45, C=18

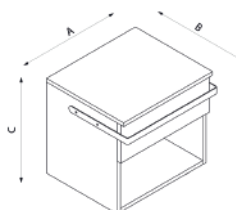

A=50, B=51, C=46

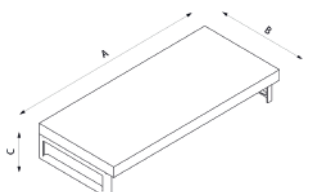

A=120, B=45, C=18

### PLOČA ZA UMIVAONIK ATLAS

ŠIFRA VOKEL	OPIS
1707025	Ogledalo Atlas 64x90
1707014	Atlas ploča za umivaonik 80 cm
1707015	Atlas ploča za umivaonik 100 cm
1707016	Atlas ploča za umivaonik 120 cm
1707017	Nosač ploče Atlas, antracit
1707018	Nosač ploče Atlas, bijeli



### Veil 50

**FRONTE:** MDF obložen PVC folijom  
**KORPUS:** MDF obložen PVC folijom  
**DEKOR:** kronberg  
**UMIVAONIK:** keramički  
**GORNJI ORMARIĆ:** led rasvjeta s prekidačem  
**BOJE:**



KRONBERG

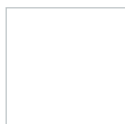

BIJELI MAT

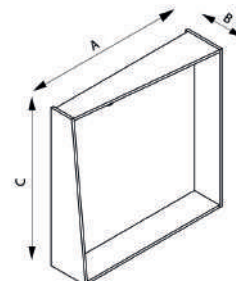

A=50, B=15, C=60

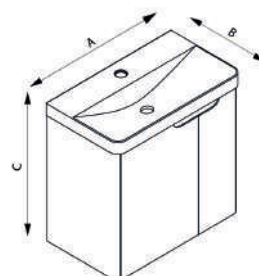

A=50, B=38, C=57

#### NAMJEŠTAJ VEIL 50 KRONBERG

ŠIFRA VOKEL	OPIS
1707029	Ogledalo Veil 50 , kronberg
1707010	Namještaj Veil 50, kronberg



### Veil 50

**FRONTE:** MDF obložen PVC folijom  
**KORPUS:** MDF obložen PVC folijom  
**DEKOR:** bijeli  
**UMIVAONIK:** keramički  
**GORNJI ORMARIĆ:** led rasvjeta s prekidačem  
**BOJE:**



KRONBERG



BIJELI MAT

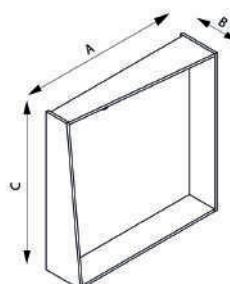

A=50, B=15, C=60

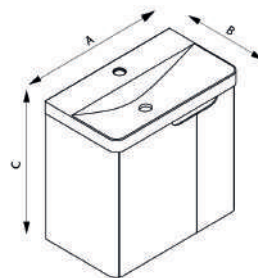

A=50, B=38, C=57

#### NAMJEŠTAJ VEIL 50 KRONBERG

ŠIFRA VOKEL	OPIS
1707029	Ogledalo Veil 50 , kronberg
1707021	Namještaj Veil 50, bijelo



**Smart 75**

**FRONTE:** MDF obložen PVC folijom  
**KORPUS:** MDF obložen PVC folijom  
**UMIVAONIK:** nadgradni umivaonik

**BOJE:**



BIJELO

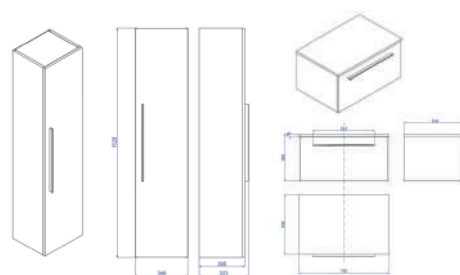

**NAMJEŠTAJ SMART 75 BIJELO - ZLATNA RUČKA**

ŠIFRA VOKEL	OPIS
1707108	Ormar donji Smart, bijelo - sjaj
1707109	Ormar bočni 150 Smart, bijelo - sjaj



**Smart 75**

**FRONTE:** MDF obložen PVC folijom  
**KORPUS:** MDF obložen PVC folijom  
**UMIVAONIK:** nadgradni umivaonik

**BOJE:**



BIJELO

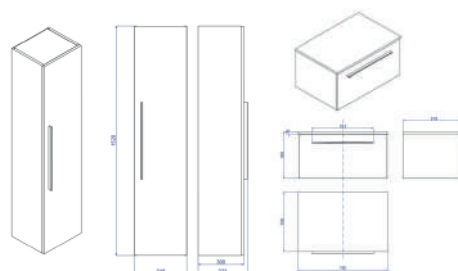

**NAMJEŠTAJ SMART 75 BIJELO - CRNA RUČKA**

ŠIFRA VOKEL	OPIS
1707110	Ormar donji Smart, bijelo - sjaj
1707111	Ormar bočni 150 Smart, bijelo - sjaj





OGLEDALO VITA

Ø70

ŠIFRA VOKEL	OPIS	Ø	Artikal
<b>1707027</b>	Ogledalo Vita 70, led rasvjeta	70	042250



OGLEDALO FRAME

Ø70

ŠIFRA VOKEL	OPIS	Ø	Artikal
<b>1707032</b>	Ogledalo Frame 70, led rasvjeta	70	15276



OGLEDALO FRAME

50x100

ŠIFRA VOKEL	OPIS	Dimenzije (cm)	Artikal
<b>1707033</b>	Ogledalo Frame 50x100, led rasvjeta	50x100	15274



OGLEDALO FRAME

60x80

ŠIFRA VOKEL	OPIS	Dimenzije (cm)	Artikal
<b>1707086</b>	Ogledalo Frame 60x80, led	60x80	15275



OGLEDALO SHINE - SENZORSKO

60x80

ŠIFRA VOKEL	OPIS	Dimenzije (cm)	Artikal
<b>1707060</b>	Ogledalo Shine 60x80, senzorsko	60x80	042121



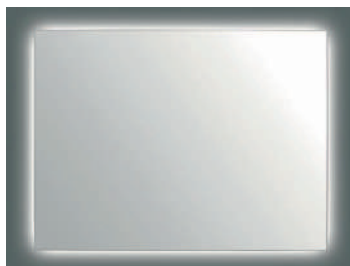

## OGLEDALO SHINE - SENZORSKO

80x100

80x120

ŠIFRA VOKEL	OPIS	Dimenzije (cm)	Artikal
<b>1707061</b>	Ogledalo Shine 80x100, senzorsko	80x100	042122
<b>1707062</b>	Ogledalo Shine 80x120, senzorsko	80x120	042123



## OGLEDALO SHINE - SENZORSKO

60x80

ŠIFRA VOKEL	OPIS	Dimenzije (cm)	Artikal
<b>1707060</b>	Ogledalo Shine 60x80, senzorsko.	60x80	042121



## OGLEDALO SHINE - LED SENZOR

Ø80

ŠIFRA VOKEL	OPIS	Ø	Artikal
<b>1707063</b>	Ogledalo Shine 80, led senzor.	80	042124



## OGLEDALO LYNN

60x80

ŠIFRA VOKEL	OPIS	Dimenzije (cm)	Artikal
<b>1707034</b>	Ogledalo Lynn 60x80, led rasvjeta.	60x80	00897

### Galaxy

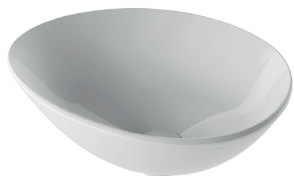

NADGRADNI UMIVAONIK

51,1x41 cm

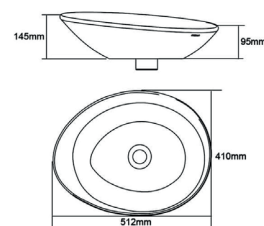

ŠIFRA VOKEL

OPIS

Art.

**0462421**

NADGRADNI UMIVAONIK GALAXY

116985

### Nysa



NADGRADNI UMIVAONIK

35x35 cm

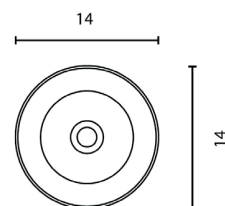

ŠIFRA VOKEL

OPIS

Art.

**0462422**

NADGRADNI UMIVAONIK NYSA

125816

### Nomia



NADGRADNI UMIVAONIK

50x39 cm

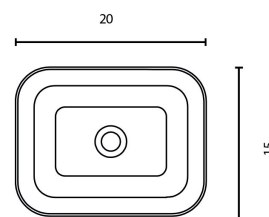

ŠIFRA VOKEL

OPIS

Art.

**0462429**

NADGRADNI UMIVAONIK NOMIA

125818

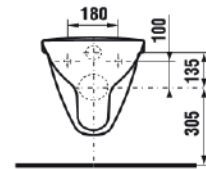
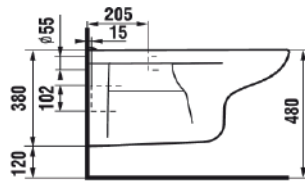
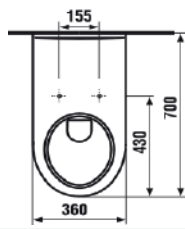

Šifra Vokel	Opis	Art.
<b>1174002</b>	VIŠEĆA WC ŠKOLJKA ZA INVALIDE DEEP JIKA	820642000001

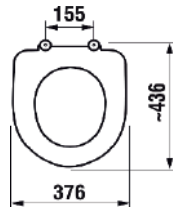

Šifra Vokel	Opis	Art.
<b>1174001</b>	WC DASKA DEEP JIKA	8932813000631

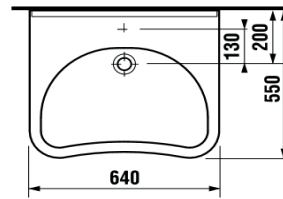
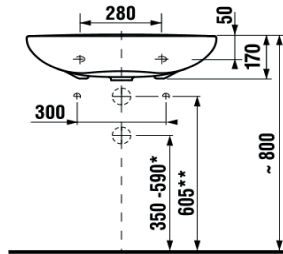

Šifra Vokel	Opis	Art.
<b>1174003</b>	UMIVAONIK ZA INVALIDE MIO 640x550 JIKA	8137140001041

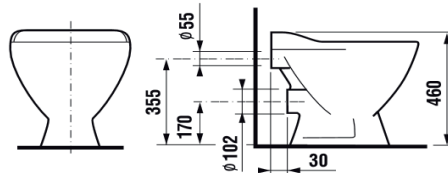
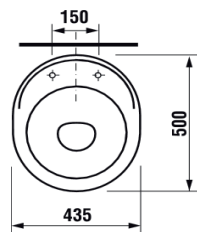

Šifra Vokel	Opis	Art.
<b>1174004</b>	TROKADERO STOJEĆI MIRA S PLASTIČNOM REŠETKOM JIKA	8510460000001

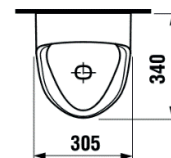
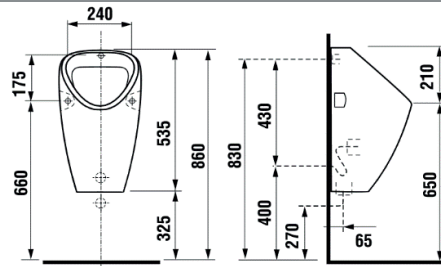

Šifra Vokel	Opis	Art.
<b>1174005</b>	PISOAR GOLEM	8430600000001



# Adele

Kolekcije sanitarnog porculana

	<p><b>1109193</b></p> <p><b>1109191</b></p> <p><b>1109194</b></p> <p><b>1109195</b></p>	<p>WC ŠKOLJKA ADELE STOJEĆA ODVOD U POD ART.344196000</p> <p>WC ŠKOLJKA ADELE STOJEĆA ODVOD U ZID ART.344195000</p> <p>WC DASKA ADELE SPOROSPUŠTAJUĆA ART.A80129200P</p> <p>WC DASKA ADELE OBIČNA ART.A80129000P</p>
	<p><b>1109196</b></p>	<p>BIDE STOJEĆI ADELE ART.355195000</p>

	<p><b>1109195</b></p>	<p>WC DASKA ADELE OBIČNA</p> <p>ART.A80129000P</p>
---	-----------------------	--

# ONA

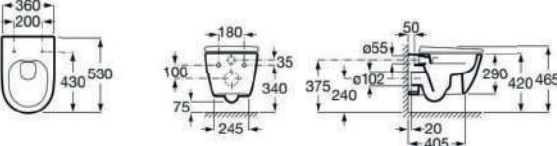
 	<p><b>1109234</b></p>	<p>WC ŠKOLJKA VISEĆA ONA 530 RIMLESS</p> <p>ART. A346687000</p>
---	-----------------------	---

	<p><b>1109235</b></p>	<p>WC DASKA ONA SPOROSPUŠTAJUĆA SUPRALIT</p> <p>ART. A801E12001</p>
---	-----------------------	---

 	<p><b>0459030</b></p>	<p>WC ŠKOLJKA SERIJA 130 ODVOD U POD      ART.B40CBO06</p>
	<p><b>0459032</b></p>	<p>WC POKLOPAC SERIJA 130      ART.B41DE025</p>
	<p><b>0459033</b></p>	<p>TUŠ SJEDALICA ZIDNA NA PREKLAPANJE NOSIVOSTI 150 kg ART.4FAUHS01</p>





## DUPLI KERAMIČKI UMIVAONIK

120 cm

\* 27.5 kg (+- %5)  
\* 163 x 1210 x 450 mm

ŠIFRA VOKEL	BOJA	ŠIFRA ARTIKLA	PAKIRANJE
<b>1177001</b>	BIJELA	4120-KL	1

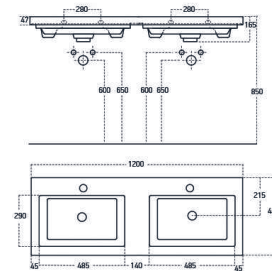

## KERAMIČKI UMIVAONIK

100 cm

\* 20.4 kg (+- %5)  
\* 170 x 1050 x 450 mm

ŠIFRA VOKEL	BOJA	ŠIFRA ARTIKLA	PAKIRANJE
<b>1177002</b>	BIJELA	4100-KL	1

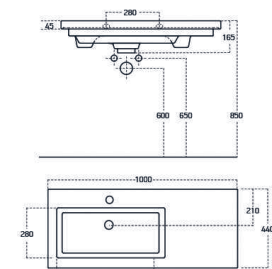

## KERAMIČKI UMIVAONIK

85 cm

\* 18.1 kg (+- %5)  
\* 170 x 855 x 450 mm

ŠIFRA VOKEL	BOJA	ŠIFRA ARTIKLA	PAKIRANJE
<b>1177003</b>	BIJELA	4085-KL	1

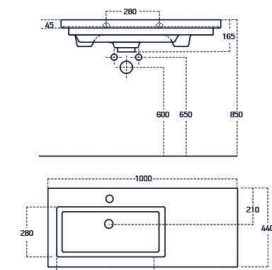

## KERAMIČKI UMIVAONIK

70 cm

\* 14.1 kg (+- %5)  
\* 160 x 715 x 448 mm

ŠIFRA VOKEL	BOJA	ŠIFRA ARTIKLA	PAKIRANJE
<b>1177004</b>	BIJELA	4070-KL	1

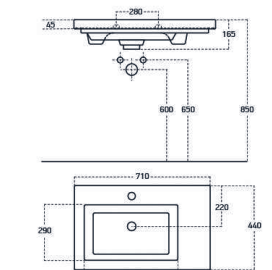

## KERAMIČKI UMIVAONIK

60 cm

\* 10.1 kg (+- %5)  
\* 170 x 550 x 450 mm

ŠIFRA VOKEL	BOJA	ŠIFRA ARTIKLA	PAKIRANJE
<b>1177005</b>	BIJELA	4060-KL	1

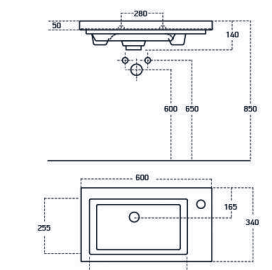

## KERAMIČKI UMIVAONIK

45 cm

\* 5.7 kg (+- %5)  
\* 150 x 507 x 277 mm

ŠIFRA VOKEL	BOJA	ŠIFRA ARTIKLA	PAKIRANJE
<b>1177006</b>	BIJELA	4045-KL	1

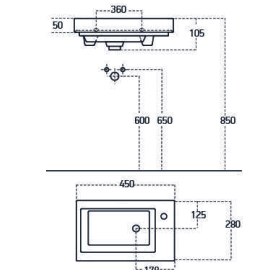



## KERAMIČKI NADPULTNI UMIVAONIK

65 cm

- \* 14,1 kg (+- %5)
- \* 175 x 655 x 483 mm

ŠIFRA VOKEL	BOJA	ŠIFRA ARTIKLA	PAKIRANJE
<b>1177007</b>	BIJELA	3066-KL	1

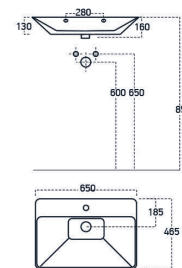

## KERAMIČKI NADPULTNI UMIVAONIK

55 cm

- \* 14,4 kg (+- %5)
- \* 148 x 555 x 505 mm

ŠIFRA VOKEL	BOJA	ŠIFRA ARTIKLA	PAKIRANJE
<b>1177008</b>	BIJELA	3054-KL	1

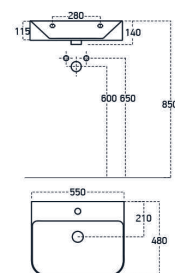

## KERAMIČKI NADPULTNI UMIVAONIK

50 cm

- \* 12,2 kg (+- %5)
- \* 160 x 510 x 490 mm

ŠIFRA VOKEL	BOJA	ŠIFRA ARTIKLA	PAKIRANJE
<b>1177009</b>	BIJELA	7050-KL	1

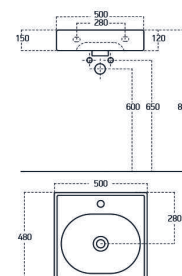

## KERAMIČKI NADPULTNI UMIVAONIK

50 cm

- \* 13,4 kg (+- %5)
- \* 105 x 500 x 380 mm

ŠIFRA VOKEL	BOJA	ŠIFRA ARTIKLA	PAKIRANJE
<b>1177011</b>	BIJELA	3050-KL	1

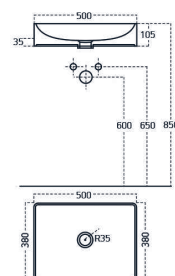

## KERAMIČKI NADPULTNI UMIVAONIK

Ø43 cm

- \* 9,2 kg (+- %5)
- \* 130 x 430 x 430 mm

ŠIFRA VOKEL	BOJA	ŠIFRA ARTIKLA	PAKIRANJE
<b>1177010</b>	BIJELA	3034-KL	1

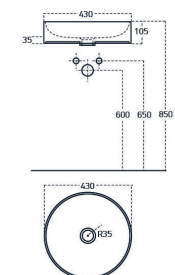



## VISEĆA WC ŠKOLJKA

GARCIA\_BRILLA

- \* 23,6 kg (+- %5)
- \* 375 x 535 x 375 mm
- \* volumen : 0.078 m<sup>3</sup>

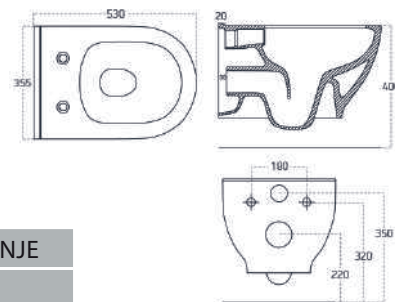

ŠIFRA VOKEL	BOJA	ŠIFRA ARTIKLA	PAKIRANJE
<b>1177016</b>	BIJELA	100614	1



## VISEĆI BIDE

GARCIA

ŠIFRA VOKEL	BOJA	ŠIFRA ARTIKLA	PAKIRANJE
<b>1177014</b>	BIJELA	100624	1



## HIGIJENSKA VISEĆA WC ŠKOLJKA

GARCIA\_RIMLESS

- \* 23,6 kg (+- %5)
- \* 375 x 535 x 375 mm
- \* volumen : 0.078 m<sup>3</sup>

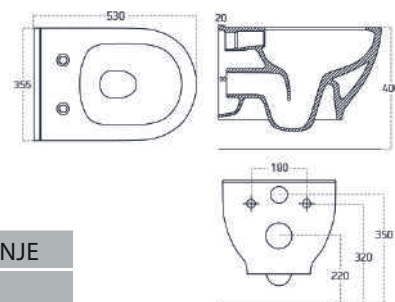

ŠIFRA VOKEL	BOJA	ŠIFRA ARTIKLA	PAKIRANJE
<b>1177015</b>	BIJELA	100612	1



## VISEĆA WC ŠKOLJKA

### RIMLESS AVANGARD



ŠIFRA VOKEL	BOJA	ŠIFRA SRTIKLA	PAKIRANJE
<b>1177020</b>	BIJELA	100314	1

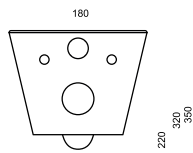
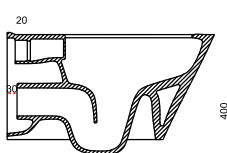
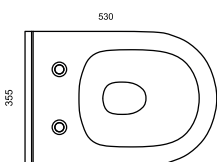

## HIGIJENSKA VISEĆA WC ŠKOLJKA

### RIMLESS AVANGARD BEZ VENTILA



ŠIFRA VOKEL	BOJA	ŠIFRA SRTIKLA	PAKIRANJE
<b>1177021</b>	BIJELA	100312	1

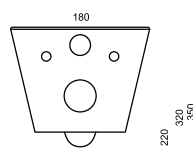
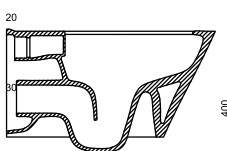
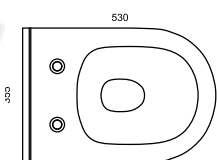

## HIGIJENSKA VISEĆA WC ŠKOLJKA

### RIMLESS AVANGARD S UGRAĐENIM VENTILOM



ŠIFRA VOKEL	BOJA	ŠIFRA SRTIKLA	PAKIRANJE
<b>1177018</b>	BIJELA	100315	1

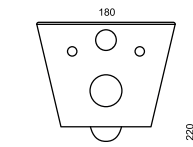
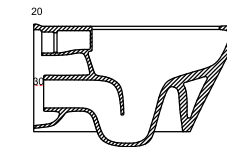
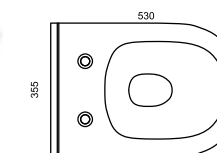

## VISEĆI BIDE

### AVANGARD



ŠIFRA VOKEL	BOJA	ŠIFRA SRTIKLA	PAKIRANJE
<b>1177019</b>	BIJELA	100324	1

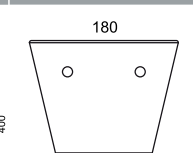
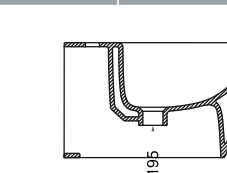
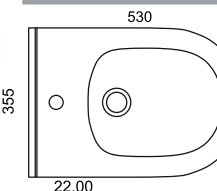

**BATERIJA ZA UMIVAONIK**

SAMO ARMATURA

ŠIFRA VOKEL	BOJA	ŠIFRA ARTIKLA	PAKIRANJE
<b>1725001</b>	KROM	00077	1

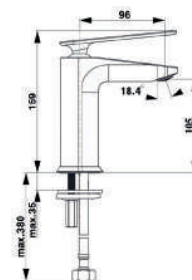
**BATERIJA ZA BIDE**

SAMO ARMATURA

ŠIFRA VOKEL	BOJA	ŠIFRA ARTIKLA	PAKIRANJE
<b>1725004</b>	KROM	00530	1

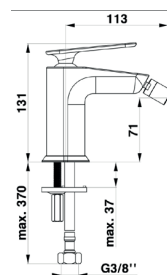
**BATERIJA ZA KADU**

SAMO ARMATURA

ŠIFRA VOKEL	BOJA	ŠIFRA ARTIKLA	PAKIRANJE
<b>1725002</b>	KROM	00330	1

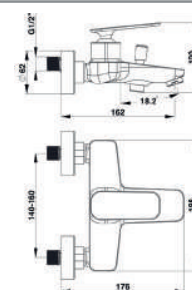
**BATERIJA ZA TUŠ**

SAMO ARMATURA

ŠIFRA VOKEL	BOJA	ŠIFRA ARTIKLA	PAKIRANJE
<b>1725003</b>	KROM	00430	1

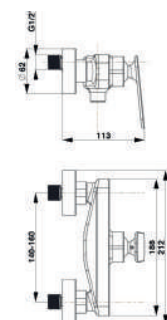



## BATERIJA ZA UMIVAONIK

SAMO ARMATURA

ŠIFRA VOKEL	BOJA	ŠIFRA ARTIKLA	PAKIRANJE
<b>1725005</b>	CRNO	00077B	1

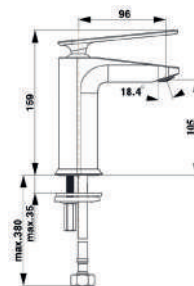

## BATERIJA ZA BIDE

SAMO ARMATURA

ŠIFRA VOKEL	BOJA	ŠIFRA ARTIKLA	PAKIRANJE
<b>1725008</b>	CRNO	00430	1

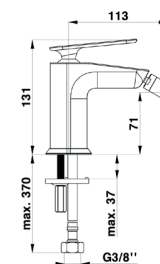

## BATERIJA ZA KADU

SAMO ARMATURA

ŠIFRA VOKEL	BOJA	ŠIFRA ARTIKLA	PAKIRANJE
<b>1725006</b>	CRNO	00330B	1

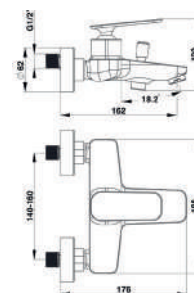

## BATERIJA ZA TUŠ

SAMO ARMATURA

ŠIFRA VOKEL	BOJA	ŠIFRA ARTIKLA	PAKIRANJE
<b>1725007</b>	CRNO	00430B	1

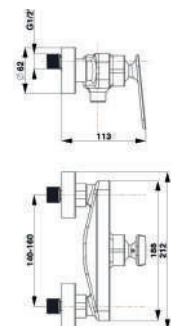





CORSICA  
UNIVERZALNA WC DASKA

ŠIFRA VOKEL	OPIS	BOJA	ART.
<b>0479001</b>	THERMOPLAST	BIJELA	522986



BALTIC  
UNIVERZALNA WC DASKA

ŠIFRA VOKEL	OPIS	BOJA	ART.
<b>0479003</b>	DUROPLAST	BIJELA	507415



STREAM  
ZA WC ŠKOLJKU VALENTINA

ŠIFRA VOKEL	OPIS	BOJA	ART.
<b>0479004</b>	DUROPLAST	BIJELA	533482



SPRING  
ZA WC ŠKOLJKU VALENTINA

ŠIFRA VOKEL	OPIS	BOJA	ART.
<b>0479008</b>	DUROPLAST	BIJELA	519131



WAVE SOFTCLOSE  
ZA WC ŠKOLJKU VALENTINA SA AMORTIZERIMA

ŠIFRA VOKEL	OPIS	BOJA	ART.
<b>0479011</b>	DUROPLAST	BIJELA	520279



COMO SOFTCLOSE  
UNIVERZALNA WC DASKA

ŠIFRA VOKEL	OPIS	BOJA	ART.
<b>0479015</b>	DUROPLAST	BIJELA	521906



## BALTIC TOP FIX

ŠIFRA VOKEL	OPIS	BOJA	ART.
<b>0479019</b>	DUROPLAST	BIJELA	528530



## FLUKE ECO SOFTCLOSE TAKE OFF

ŠIFRA VOKEL	OPIS	BOJA	ART.
<b>0479022</b>	DUROPLAST	BIJELA	532316



## PERCA SOFTCLOSE

ŠIFRA VOKEL	OPIS	BOJA	ART.
<b>0479024</b>	DUROPLAST	BIJELA	534043



## REVO

ŠIFRA VOKEL	OPIS	BOJA	ART.
<b>0479025</b>	DUROPLST	BIJELA	534998, 536026, 533948

BACAN (BANOCA) TAKE OFF  
ZA WC ŠKOLJKU LAUFEN PRO NEW

ŠIFRA VOKEL	OPIS	BOJA	ART.
<b>0479026</b>	DUROPLAST	BIJELA	531412, 532430

RAY SOFTCLOSE  
ZA WC ŠKOLJKU LAUFEN PRO

ŠIFRA VOKEL	OPIS	BOJA	ART.
<b>0479027</b>	DUROPLAST	BIJELA	531339



**RAY SOFTCLOSE TAKE OFF**

ZA WC ŠKOLJKU LAUFEN PRO NEW, AVANGARD, GARCIA, VELA

ŠIFRA VOKEL	OPIS	BOJA	ART.
<b>0479028</b>	DUROPLAST	BIJELA	536117



**RAY SOFTCLOSE TOP FIX**







ZA WC ŠKOLJKU MAGIS

ŠIFRA VOKEL	OPIS	BOJA	ART.
<b>0479030</b>	DUROPLAST	BIJELA	531784, 533421



**PICCO 2.0 SOFTCLOSE TAKE OFF**

ŠIFRA VOKEL	OPIS	BOJA	ART.
<b>0479029</b>	DUROPLAST	BIJELA	539987

	<p><b>12433</b></p> <p><b>12434</b></p> <p><b>0526151</b></p> <p><b>0526148</b></p>	<p>KUĆIŠTE 3/4 ZA FILTER ART.FHPR34</p> <p>KUĆIŠTE 1" ZA FILTER ART.FHPRI</p> <p>GUMICA ZA KUĆIŠTE 5coll OR-APC</p> <p>GUMICA ZA KUĆIŠTE 10coll OR-AQYT</p>
	<p><b>12444</b></p>	<p>FILTER ZA PROČIŠĆAVANJE VODE ART.FCPS20</p>
	<p><b>12717</b></p>	<p>FILTER ZA OMEKŠAVANJE VODE ART.FCCST</p>
	<p><b>12716</b></p>	<p>FILTER ZA PROČIŠĆAVANJE VODE I UKLANJANJE KLORA ART.FCCBL</p>
	<p><b>0526144</b></p> <p><b>0526143</b></p> <p><b>0526145</b></p>	<p>FILTER PATRONA SITO ART.FCPNN 50M</p> <p>FILTER PATRONA SITO ART.FCPNN 100 M</p> <p>FILTER PATRONA SITO ART.FCPNN 150M-A</p>
	<p><b>12985</b></p>	<p>FILTER ZA VODU ART. FHCTF</p>

# Ventilator BWN100WS

**Š.Vokel****Opis****0207069** VENTILATOR BVN 100 WS ART.474564**Tehničke karakteristike:**Snaga motora **15 W**Protok zraka: **70 m<sup>3</sup>/h**Razina buke (max.): **33dB**Broj okretaja: **2.400 okr/min**Način ugradnje: **na zid, strop, prozor**Boja: **Bijela**Visina (A): **158 mm**Dubina do zida (B): **21 mm**Duljina odvodne cijevi (C): **55 mm**Promjer odvodne cijevi (D): **98 mm**Promjer otvora u zidu: **100 mm**Dimenzije zapakiranog aparata (ŠxVxD): **16,2 x 8 x 16,5 cm**Neto težina aparata: **0,5 kg**Bruto težina aparata: **0,59 kg**

Ventilator se jednostavno uključuje pritiskom prekidača

### Kombinirani bojler 80 Litara / lijevi

## TGRK80LNG

pod pritiskom/tlačni



Visokokvalitetna izolacija

Š.VOKEL	OPIS
<b>0207071</b>	BOJLER TGRK 80 LNG ART.479159

Vrsta bojlera: **pod pritiskom/ tlačni**  
 Profil upotrebe: **M**  
 Energetski razred: **C**  
 Energetska učinkovitost zagrijavanja vode nwh: **36 %**  
 Potrošnja energije kWh/24 h: **6,7 kWh**  
 Podešavanje temperature termostata: **eco**  
 Smart vrijednost: **0**  
 Zapremina: **71,3 l**

Broj odvodnih mjesta: **2 ili više**  
 Način montaže: **Vertikalno na zid**

Priključci na vodovodnu mrežu: **G 1/2**  
 Izmjenjivač topline: **G 3-4**

Radni pritisak: **6 bar**  
 Materijal kotla: **Čelični emajlirani lim**  
 Zaštitna anoda: **Zaštitna magnezijumska anoda**  
 Regulacija temperature: **Elektromehanička**  
 Termometar: **Bimetalni termometar**  
 Zaštita od zamrzavanja: **Da**  
 Signalno svjetlo - prikaz grijanja: **Da**

Površina izmjenjivača: **0,25 m2**  
 Maksimalni pritisak: **6 bar**  
 Maksimalna temperatura: **85 °C**

Broj električnih grijača: **1**  
 Priklijuna snaga: **2.000 W**  
 Priključni napon: **230 V**  
 Nazivna struja: **8,7 A**

Toplotni gubitci (kWh/24) - vertikalna montaža: **1,32 kWh/24**

Dimenzije aparata (ŠxVxD): **45,4 × 79 × 46,1 cm**  
 Dimenzije aparata u ambalaži (ŠxVxD): **48,8 × 80 × 49,8 cm**  
 Masa aparata: **31 kg**  
 Bruto težina aparata: **33 kg**  
 Osigurač: **10 A**

### Kombinirani bojler 80 Litara / desni

## TGRK80DNG

pod pritiskom/tlačni



Visokokvalitetna izolacija

Š.VOKEL	OPIS
<b>0207072</b>	BOJLER TGRK 80 DNG ART.479160

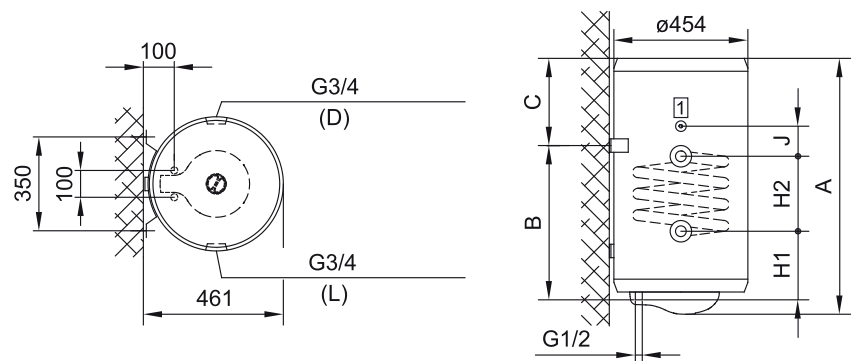

	A	B	C	H1	H2	J
TGRK 80 D/L	790	565	205	222	200	80

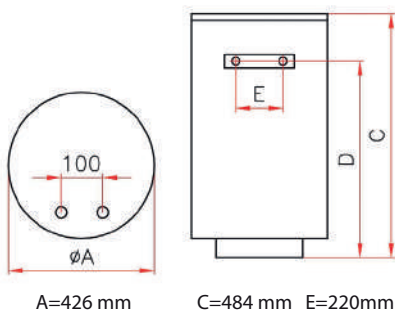

**35 LITARA**

- Boja: Bijela
- Volumen: 35 litara
- Jedno ili više odljernih mjesta: +
- Pričvršćenje: okomito na zid
- Broj osoba uz prosječnu uporabu: 1-2
- Priključci za vodu: G=1/2"
- Masa praznog / s vodom: 14/49 kg
- Radni tlak: 8 bar
- Sigurnosni ventil 6 bara
- Nazivna snaga: 1500 W
- Nazivni napon: 230 V ~

ŠIFRA VOKEL	OPIS	ŠIFRA ARTIKLA
<b>0209032</b>	BOJLER KONČAR 35 litara VANJSKA REGULACIJA EGV35C2RA	TYLS00

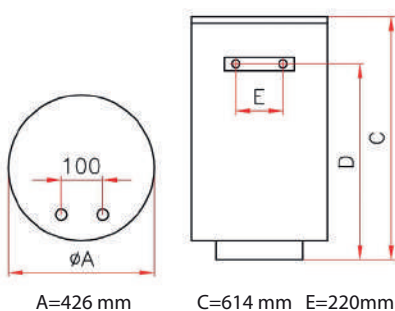
**50 LITARA**

- Boja: Bijela
- Volumen: 50 litara
- Jedno ili više odljernih mjesta: +
- Pričvršćenje: okomito na zid
- Broj osoba uz prosječnu uporabu: 2-3
- Priključci za vodu: G=1/2"
- Masa praznog / s vodom: 16/66 kg
- Radni tlak: 8 bar
- Sigurnosni ventil 6 bara
- Nazivna snaga: 1980 W
- Nazivni napon: 230 V ~

ŠIFRA VOKEL	OPIS	ŠIFRA ARTIKLA
<b>0209033</b>	BOJLER KONČAR 50 litara UNUTARNJA REGULACIJA EGV50C2TA	TYNA00

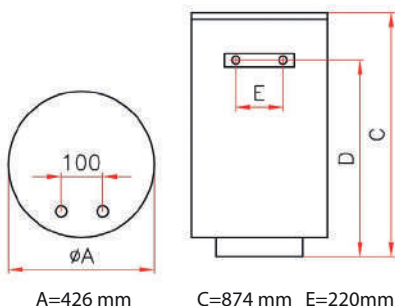
**80 LITARA**

- Boja: Bijela
- Volumen: 80 litara
- Jedno ili više odljernih mjesta: +
- Pričvršćenje: okomito na zid
- Broj osoba uz prosječnu uporabu: 3-4
- Priključci za vodu: G=1/2"
- Masa praznog / s vodom: 21/101 kg
- Radni tlak: 8 bar
- Sigurnosni ventil 6 bara
- Nazivna snaga: 1980 W
- Nazivni napon: 230 V ~

ŠIFRA VOKEL	OPIS	ŠIFRA ARTIKLA
<b>0209034</b>	BOJLER KONČAR 80 litara UNUTARNJA REGULACIJA EGV80C2TA	TYND00

# VELIS WIFI



AQUA ARISTON NET



EMAJILIRANI GRUJAI ELEMENT



TITAN OBLAGA



PLITAK



MULTIPOZICIJSKI



TALIJSKI DIZAJN

- / Ugrađen Wi-Fi za daljinsko upravljanje putem pametnog telefona
- / Aplikacija Aqua Ariston NET: jednostavna interakcija, ušteda energije do 25% i brze povratne informacije o performansama.

ENERGETSKI RAZRED



- / Ekskluzivni talijanski dizajn
- / Elegantna brušena prednja ploča od metala
- / Kompaktan dizajn, dubine samo 27 cm

- / Mogućnost montaže u više položaja
- / Jednostavan zaslon na dodir
- / Funkcija ECO EVO

- / Emajlirani grijači element
- / Unutarnji rezervoar od titana, testiran na 16 bara
- / Visoko precizni senzori temperature
- / Dvije magnezijeve anode
- / Dvije prirubnice s 5 vijaka
- / Sigurnosni ventil testiran na 8 bara
- / Ekološka poliuretanska izolacija



Procijenjena ušteda do 25% na dnevnoj bazi, u odnosu na standardne mehaničke proizvode tvrtke Ariston.

**TEHNIČKI PODATCI**

		50	80	100
Nazivni kapacitet	l	50	80	100
Miješana voda pri 40°C**	°C	80	125	156
Montaža	V/H	V/H	V/H	V/H
Snaga	kW	1,5	1,5	1,5
Grijači element		Emajlirano	Emajlirano	Emajlirano
Napon	V	230	230	230
Vrijeme zagrijavanja(ΔT=45°C)	h,min	1,30	2,15	2,5
Maks. radni tlak	bar	8	8	8
Maks. radna temperatura	°C	80	80	80
Težina	kg	21,7	28,3	32,2
Klasa zaštite	IP	X4	X4	X4

**UKUPNE DIMENZIJE**

		50	80	100
a	mm	776	1066	1251
b	mm	405	695	880

Vertikalna ugradnja, temperatura od 65°C

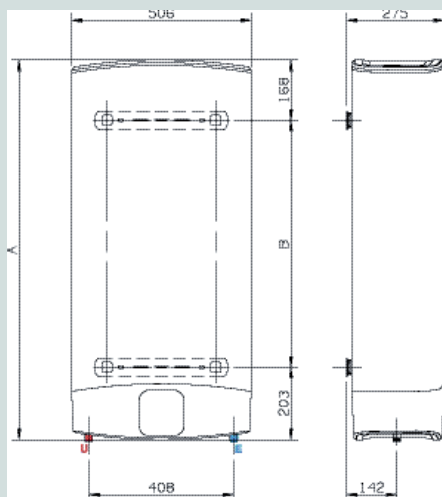
**VELIS WIFI EU**

		50	80	100
Energetski razred		B	B	B
	Profil ispuštanja	M	M	M
ŠIFRA		3626323	3626324	3626325

**Š.Vokel Opis**

<b>0211088</b>	BOJLER VELIS VLS WIFI 50 EU	ART.3626323
<b>0211089</b>	BOJLER VLS WIFI 80 EU	ART.3626324

**LEGENDA**

- E** Ulaz hladne vode G 1/2"
- U** Izlaz vruće vode G 1/2"

# LYDOS ECO

novo



WATER-PLUS  
TEHNOLOGIJA



EKO EVO  
FUNKCIJA



POTPUNI  
SIGURNOSNI  
SUSTAV



ENERGETSKI  
UČINKOVIT



ZAŠTIĆENO  
TITANOM



TALIJSKI  
DIZAJN



SPREMAN ZA  
TUŠIRANJE



LED ZASLON

## NAPREDNI UČINAK

WaterPlus tehnologija: do 16% više dostupne tople vode  
Eko Evo funkcija powered by CoreTech: do 14% uštede energije  
U skladu s najvišim propisima ESWH-a

## PUNA UDOBNOST

Ručno i precizno podešavanje temperature  
Ikona spremna za tuširanje koja prikazuje prvu dostupnost tuširanja  
Apsolutni sigurnosni sustav koji štiti dobro funkcioniranje proizvoda  
T-MAX funkcija suočava se s neočekivanom potrebom tople vode

## JEDNOSTAVNO KVALITETAN

Vrhunski i robustan izolacijski materijal koji je prihvatljiv za okoliš  
Magnezijeva anoda za borbu protiv korozije  
Visokokvalitetni titanski emajlirani spremnik

## EKSKLUZIVNI PROJEKT

100% napravljen i dizajniran u Italiji  
Moderni oblik s "Ariston valom" i optimiziran plastični poklopac  
LED HMI za jednostavne i brze povratne informacije o proizvodu  
High-Tech korisničko sučelje

Tehnički podatci		50 V	80 V	100 V
Instalacija		Okomito	Okomito	Okomito
Kapacitet	l	50	80	100
Snaga	kW	2	2	2
Vrijeme zagrijavanja(ΔT = 45°C)	h:min.	1:18'	1:58'	2:29'
Maks. radna temperatura	°C	80	80	80
Toplinski gubici na 65°C	kWh/24h	0,99	1,35	1,56
Maksimalni radni tlak	bar	8	8	8
Težina	kg	16	20,5	24
IP zaštita	IP	IPX3	IPX3	IPX3
Višina/Širina/Dubina	mm	528/450/470	733/450/470	885/450/470
Energetski razred		B	B	B
Profil kapaciteta		M	M	M

Š.Vokel	Opis	
0211080	BOJLER LYDOS ECO 50 lit	ART.3201860
0211081	BOJLER LYDOS ECO 80 lit	ART.3201861



# PRO 1 R VTD/MTS EU

80-100 lt

**Novo**



WATER-PLUS  
TEHNOLOGIJA



REGULACIJA  
VANJSKE  
TEMPERATURE



TERMOSTAT ZA  
DVOSTRUKU  
SIGURNOST



UČINKOVITA  
IZOLACIJA



ZAŠTIĆENO  
TITANOM



TALIJANSKI  
DIZAJN

### NAPREDNI UČINAK

WaterPlus tehnologija: do 16% više dostupne tople vode  
U skladu s najvišim propisima ESWH-a

### PUNA UDOBNOST

Ručno i precizno podešavanje temperature

### JEDNOSTAVNO KVALITETAN

Vrhunski i robustan izolacijski materijal koji je prihvatljiv za okoliš  
Moderan talijanski dizajn  
Magnezijeva anoda za borbu protiv korozije  
Visokokvalitetni titanski emajlirani spremnik testiran na 16 bara

Tehnički podatci		PRO 1 R 80 VTD	PRO 1 R 80 VTS	PRO 1 R 100 VTD	PRO 1 R 100 VTS
Instalacija		Okomito	Okomito	Okomito	Okomito
Kapacitet	l	80	80	100	100
Snaga	kW	1,8	1,8	1,8	1,8
Vrijeme zagrijavanja(ΔT = 45°C)	h:min.	2:11'	2:11'	2:46'	2:46'
Maks. radna temperatura	°C	75	75	75	75
Toplinski gubici na 65°C	kWh/24h	1,51	1,51	1,62	1,62
Maksimalni radni tlak	bar	8	8	8	8
Težina	kg	21,5	21,5	25	25
IP zaštita	IP	IPX3	IPX3	IPX3	IPX3
Višina/Širina/Dubina	mm	748/450/480	748/450/480	900/450/480	900/450/480
Energetski razred		C	C	C	C
Profil kapaciteta		M	M	L	L

Š.Vokel

Opis

**0211084** BOJLER KOMBINIRANI PRO1R 100 lit LIJEVI ART.3201817



# PRO 1 ECO EU

120-150 lt

novo



WATER-PLUS  
TEHNOLOGIJA



EKO EVO  
FUNKCIJA



POTPUNI  
SIGURNOSNI  
SUSTAV



EKO ZASLON



ZAŠTIĆENO  
TITANOM



TALLJANSKI  
DIZAJN



SPREMAN ZA  
TUŠIRANJE



UČINKOVITA  
IZOLACIJA

## UZ SVE KARAKTERISTIKE MODELA PRO 1 R MODEL JE NADOGRAĐEN FUNKCIJAMA:

- / ECO EVO FUNKCIJA SA CORETECH  
TEHNOLOGIJOM: DO 14% UŠTEDE
- / PRIKAZ DOSTUPNOSTI VODE ZA PRVO TUŠIRANJE
- / T-MAX FUNKCIJA ZA BRŽU PRIPREMU TOPLE VODE
- / VIZUALIZACIJA POMOĆU LED SUSTAVA

Tehnički podatci		120	150
Instalacija		Okomito	Okomito
Kapacitet	l	120	150
Snaga	kW	2	2
Vrijeme zagrijavanja(ΔT = 45°C)	h:min.	3:08'	3:55'
Maks. radna temperatura	°C	80	80
Toplinski gubici na 65°C	kWh/24h	1,6	1,65
Maksimalni radni tlak	bar	8	8
Težina	kg	27,6	32,4
IP zaštita	IP	IPX3	IPX3
Višina/Širina/Dubina	mm	1108/450/470	1283/450/470
Energetski razred		C	C
Profil kapaciteta		L	L

Š.Vokel

Opis

**0211085** BOJLER PRO1 ECO R 150 lit ART.3700569





# PRO 1 R

50-80-100 lt

novo



WATER-PLUS  
TEHNOLOGIJA



REGULACIJA  
VANJSKE  
TEMPERATURE



TERMOSTAT ZA  
DVOSTRUKU  
SIGURNOST



UČINKOVITA  
IZOLACIJA



ZAŠTIĆENO  
TITANOM



TALIJANSKI  
DIZAJN

## NAPREDNI UČINAK

WaterPlus tehnologija: do 16% više dostupne tople vode  
U skladu s najvišim propisima ESWH-a

## PUNA UDOBNOST

Ručno i precizno podešavanje temperature  
Jednostavno korisničko sučelje sa povratnom informacijom o grijanju

## JEDNOSTAVNO KVALITETAN

Vrhunski i robusan izolacijski materijal koji je prihvatljiv za okoliš  
Magnezijeva anoda za borbu protiv korozije  
Moderan talijanski dizajn  
Visokokvalitetni titanski emajlirani spremnik testiran na 16 bara

Tehnički podatci		50V	80V	100V
Instalacija		Okomito	Okomito	Okomito
Kapacitet	l	50	80	100
Snaga	kW	2	2	2
Vrijeme zagrijavanja(ΔT = 45°C)	h:min.	1:18'	1:58'	2:29'
Maks. radna temperatura	°C	75	75	75
Toplinski gubici na 65°C	kWh/24h	0,99	1,35	1,56
Maksimalni radni tlak	bar	8	8	8
Težina	kg	16	20,5	24
IP zaštita	IP	IPX3	IPX3	IPX3
Višina/Širina/Dubina	mm	543/450/480	748/450/480	900/450/480
Energetski razred		/	/	/
Profil kapaciteta		/	/	/

### Š.Vokel

### Opis

<b>0211082</b>	BOJLER PRO1R 50V 50 lit S VANJSKOM REGULACIJOM ART.3201810
<b>0211083</b>	BOJLER PRO1R 80V 80 lit S VANJSKOM REGULACIJOM ART.3201811





# VELIS EVO



PAMETNI IZBORNIK



SPREMAN TUŠ



FUNKCIJA ECO EVO



GRUJAČI ELEMENT EMAJLIAN LEGUROM INCOLOY



SIGURNOSNI PAKET



TITANIUM PLUS



PLOSNAT



VIŠE POLOŽAJA



TALJANSKI DIZAJN



PAMETNI ZASLON

PAMETNA struktura dvostrukog spremnika: topao tuš spreman je za



- / Moderan i ekskluzivan dizajn
- / Multifunkcionalni LCD displej
- / Instalacija Više pozicija H/V

- / Funkcija ECO EVO (patentirano)
- / Funkcija spreman za tuširanje

- / Izoliran od buke, emajliran
- / Kotao od emajliranog titana na 850°C
- / Dvostruka magnezijiska dioda



KATEGORIJA NAJBOLJI ENERGETSKI RAZRED\*\*



- PAMETNI zaslon osjetljiv na dodir Blue Tech**
- / Broj dostupnih tuširanja
  - / Vrijeme čekanja do sljedećeg tuširanja
  - / Dnevno programiranje



## TEHNIČKI PODACI

VLS EVO 50

VLS EVO 80

VLS EVO 100

	I	50	80	100
Kapacitet		50	80	100
Instalacija		Više položaja (V/H)	Više položaja (V/H)	Više položaja (V/H)
Snaga	KW	1,5	1,5	1,5
Napon	V	230	230	230
Vrijeme zagrij. ( $\Delta T=45^{\circ}C$ )	h,min	1,30	2,15	2,50
Vrijeme zagrij za 1. tuširanje	min	50	50	50
Maks. radni tlak	bar	8	8	8
Maks. radna temperatura	$^{\circ}C$	80	80	80
Težina	Kg	21,7	28,3	32,2
Gubitak topline na 65°C	KWh/24h	1,1	1,5	1,6
Zaštita	IP	IPX4	IPX4	IPX4

## UKUPNE DIMENZIJE

	mm	776	1066	1251
a	mm	776	1066	1251
b	mm	405	695	880

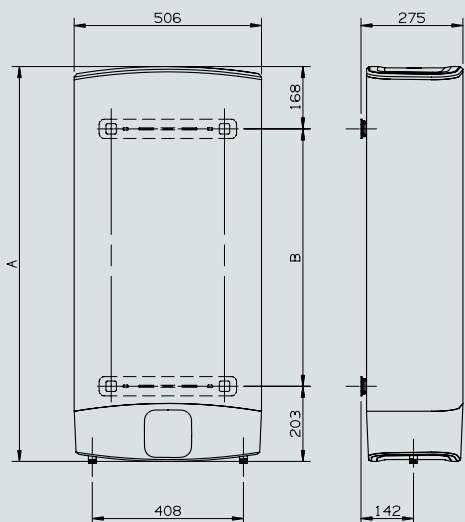

## Vertikalna/horizontalna montaža

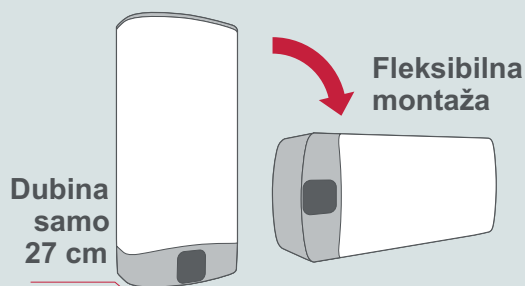

Dubina samo 27 cm

Fleksibilna montaža

## VELIS EVO

	50 EU	80 EU	100 EU
Energetska klasa	B	B	B
Oznaka kapaciteta	M	M	M

## TVORNIČKI ARTIKL





3626145 3626146 3626147



## Š.Vokel

## Opis

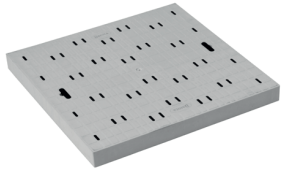
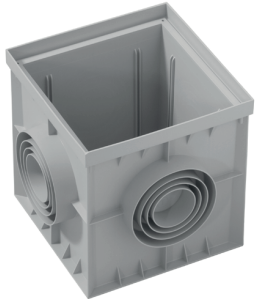
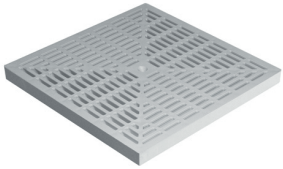
0211074	BOJLER VELIS VLS EVO 50 lit	ART.3626145
0211075	BOJLER VELIS VLS EVO 80 lit	ART.3626146
0211076	BOJLER VELIS VLS EVO 100 lit	ART.3626147

OMOGUĆIO CoreTECH

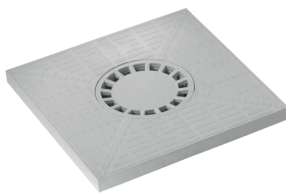
	Šifra Vokel	Opis	Art.
	<b>0170001</b>	Kanalica modularna 100x35x1000 mm dakota Pegasus Plus s rešetkom - siva.	POZ90-1335P
	<b>0170002</b>	Završni komad Dakota za kanalicu h-35, set sivi.	POZ95-1335T
	<b>0170003</b>	PP poklopac pješački 200x200 mm sa ručkom.	POZ02-1348M
	<b>0170004</b>	PP poklopac pješački 300x300 mm sa ručkom.	POZ02-1358M
	<b>0170005</b>	PP poklopac pješački 400x400 mm sa ručkom.	POZ02-1368M
	<b>0170006</b>	PP poklopac pješački 550x550 mm sa ručkom.	POZ0-1378AM
	<b>0170007</b>	PP poklopac pješački 700x700 mm sa dvije ručke.	POZ02-7070M
	<b>0170008</b>	PP šaht sa dnom 200x200 mm.	POZ01-1372S
	<b>0170009</b>	PP šaht sa dnom 300x300 mm.	POZ01-1373S
	<b>0170010</b>	PP šaht sa dnom 400x400 mm.	POZ01-1374S
	<b>0170011</b>	PP šaht sa dnom 550x550 mm.	POZ01-1371
	<b>0170012</b>	PP šaht sa dnom 700x700 mm.	POZ01-1370
	<b>0170027</b>	Rešetka za šaht bez ručke 300x300 mm.	POZ03-1357
	<b>0170028</b>	Rešetka za šaht bez ručke 400x400 mm.	POZ03-1367
	<b>0170029</b>	Rešetka za šaht bez ručke 500x500 mm.	POZ03-1377A
	<b>0170030</b>	Rešetka za šaht sa ručkom 300x300 mm.	POZ03-1357M
	<b>0170031</b>	Rešetka za šaht sa ručkom 400x400 mm.	POZ03-1367M
	<b>0170032</b>	Rešetka za šaht sa ručkom 550x550 mm.	POZ03-1377AM

	Šifra Vokel	Opis	Art.
	<b>0170033</b>	Poklopac za šaht sa sifonom 300x300 mm.	POZ09-1361S
	<b>0170034</b>	Poklopac za šaht sa sifonom 400x400 mm.	POZ09-1371S
	<b>0170035</b>	Poklopac za šaht sa sifonom 550x550 mm.	POZ09-1381S
	<b>0170013</b>	Križići 1 mm 200/1.	TER04-1201X
	<b>0170014</b>	Križići 2 mm 200/1.	TER04-1202X
	<b>0170015</b>	Križići šuplji 3 mm 200/1.	TER04-1203
	<b>0170016</b>	Križići šuplji 4 mm 200/1.	TER04-1204X
	<b>0170017</b>	Križići šuplji 5 mm 200/1.	TER04-1205
	<b>0170018</b>	Križići šuplji 7 mm 200/1.	TER04-1207
	<b>0170019</b>	Križići šuplji 10 mm 200/1.	TER04-1200
	<b>0170020</b>	T-Križići 1 mm 200/1.	TER04-1201T
	<b>0170021</b>	T-Križići 2 mm 200/1.	TER04-1202T
	<b>0170022</b>	T-Križići šuplji 3 mm 200/1.	TER04-1204
	<b>0170023</b>	T-Križići šuplji 4 mm 200/1.	TER04-1204T
	<b>0170024</b>	T-Križići šuplji 5 mm 200/1.	TER04-1206
	<b>0170025</b>	T-Križići šuplji 7 mm 200/1.	TER04-1208
	<b>0170026</b>	T-Križići šuplji 10 mm 200/1.	TER04-1201

## SET sifon "MINI" za klima uređaje

### GLAVNE KARAKTERISTIKE:

- Kolona hidrauličnog zatvaranja od 50 mm
- Gornji dio napravljen od gume
- Unutarnji dijelovi zamjenjivi za periodičnu kontrolu i čišćenje
- Glavno tijelo ima ispust na 90° da bi smanjio ukupnu dimenziju
- Reverzibilno postavljanje desno/lijevo, sa ili bez kutije za ugradnju
- Izlaz za odvodnu rebrastu cijev D18/20
- Dodatno koljeno 90° za vertikalni ispust vode
- Sifon funkcionira jedino u vertikalnom položaju sa gumenom navlakom na ulazu pozicionirana na vrhu.



### SET sifon "MINI" RADI BEZ VODE

Sa vertikalnim i horizontalnim izlazom, kompletiran s O - prstenom.

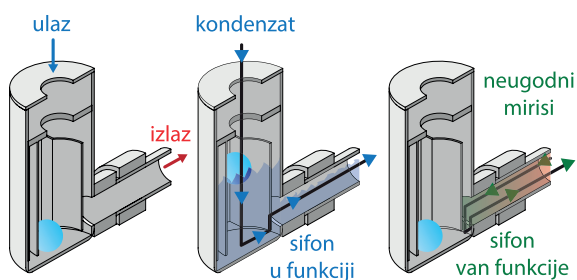

### SET sifon "MINI" za klima uređaje



- Sifon
- Kutija s poklopcem i vijcima
- O - prsten
- Brtva

Š.Vokel

Opis

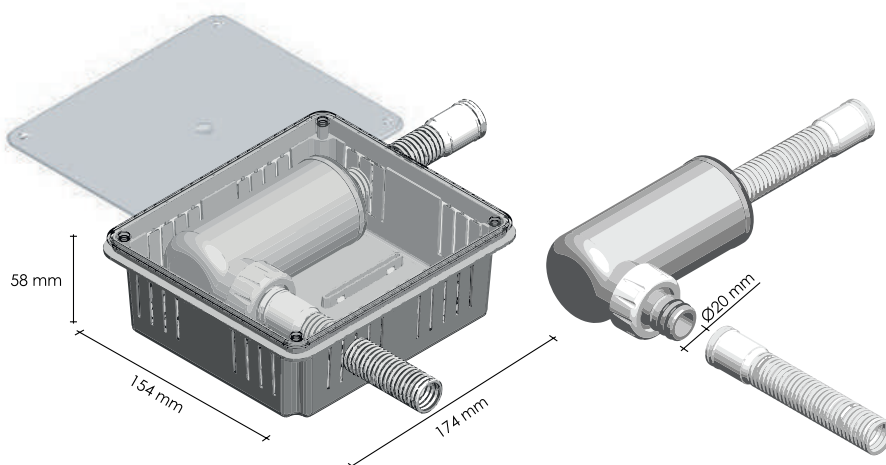
0225092 SET SIFON MINI ZA KLIMA UREĐAJE ART.989924201



	<b>0225095</b>	NIPEL SPOJNICA ZA CIJEVI KLIMA	1/4" - 1/4"	ART.9020071
	<b>0225096</b>	NIPEL SPOJNOICA ZA CIJEVI KLIMA	3/8" - 3/8"	ART.9020072
	<b>0225097</b>	NIPEL SPOJNICA ZA CIJEVI KLIMA	1/2" - 1/2"	ART.9020073
	<b>0225098</b>	NIPEL SPOJNICA ZA CIJEVI KLIMA	5/8" - 5/8"	ART.9020074
	<b>0225099</b>	MATICE ZA NIPEL SPOJNICE ZA CIJEVI KLIME	1/4"	ART.9020061
	<b>0225100</b>	MATICE ZA NIPEL SPOJNICE ZA CIJEVI KLIME	3/8"	ART.9020062
	<b>0225101</b>	MATICE ZA NIPEL SPOJNICE ZA CIJEVI KLIME	1/2"	ART.9020063
	<b>0225102</b>	MATICE ZA NIPEL SPOJNICE ZA CIJEVI KLIME	5/8"	ART.9020064
	<b>0225109</b>	REDUCIRANI NIPEL SPOJ	3/8" - 1/2"	ART.9020102
	<b>0225110</b>	REDUCIRANI NIPEL SPOJ	1/2" - 5/8"	ART.9020103
	<b>0225111</b>	REDUCIRANI NIPEL SPOJ	3/8" - 5/8" 10 m	ART.9020106

	<b>0225103</b>	REDUKCIJA ZA KLIME	1/4"-3/8"	ART.9020201
	<b>0225104</b>	REDUKCIJA ZA KLIME	3/8" - 1/4"	ART.9020203
	<b>0225105</b>	REDUKCIJA ZA KLIME	3/8" - 1/2"	ART.9020204
	<b>0225106</b>	REDUKCIJA ZA KLIME	1/2" - 5/8"	ART.9020206
	<b>0225107</b>	REDUKCIJA ZA KLIME	5/8" - 1/2"	ART.9020207
	<b>0225108</b>	REDUKCIJA ZA KLIME	1/2" - 3/8"	ART.9020205
	<b>0225112</b>	BAKRENA BRTVA ZA SPOJNICE	1/4"	ART.9020051
	<b>0225113</b>	BAKRENA BRTVA ZA SPOJNICE	3/8"	ART.9020052
	<b>0225114</b>	BAKRENA BRTVA ZA SPOJNICE	1/2"	ART.9020053
	<b>0225115</b>	BAKRENA BRTVA ZA SPOJNICE	5/8"	ART.9020054
	<b>0225117</b>	MIRISNI OSVJEŽIVAČI KLIMA GREEN APPLE (SET 10 KOMADA)		ART.910501503
	<b>0225118</b>	MIRISNI OSVJEŽIVAČI KLIMA SWEET AROMA (SET 10 KOMADA)		ART.9910501501
	<b>0225119</b>	MIRISNI OSVJEŽIVAČI KLIMA VANITY HOME (SET 10 KOMADA)		ART.910501502
	<b>0225120</b>	MIRISNI OSVJEŽIVAČ KLIMA VANILLA (SET 10 KOMADA)		ART.910501504
	<b>0225116</b>	SPREJ ZA ČIŠĆENJE I DEZINFEKCIJU	400ML	ART.9105001





### GLAVNE KARAKTERISTIKE:

- ▶ Otpor
- ▶ Lakoća
- ▶ Jednostavno korištenje
- ▶ Otporan na vanjske utjecaje

Nosači su certificirani prema TUV SUD-GS standardima, koji jamče:

- visoku kvalitetu materijala,
- točan dizajn i
- veću sigurnost za krajnjeg korisnika

ŠIFRAV OKEL	OPIS	DIMENZIJE (mm)	NOSIVOST (kg)	ART.
<b>0225124</b>	PVC POLYAMIDE NOSAČ KLIME	450 x 450	110	9794-511-08
<b>0225125</b>	PVC POLYAMIDE NOSAČ KLIME	520 x 450	90	9794-512-08

### PREDMONTA NA KUTIJA DUPLI UNUTRAŠNJI ODVOD



VOKEL ŠIFRAB	OJAD	IMENZIJA (cm)A	RTIKAL
<b>0225147</b>	BIJELA	430x108x50	9899-028-01

	<p><b>1432001</b></p>	<p>PUMPA ZA VODU DAB JETINOX 102M Q=0,6-3,6 m<sup>3</sup>/h, H=47-28,8m, P1 max=1,13 Kw</p> <p>ART.102640040</p>
	<p><b>1432004</b></p>	<p>PUMPA ZA VODU DAB EUROINOX 40/80M Q=1,2-7,2 m<sup>3</sup>/h, H=58-16m, P1 max=1,48 Kw</p> <p>ART.102970360</p>
	<p><b>1432002</b></p>	<p>PUMPA ZA VODU DAB BOOSTER SILENT 4M Q=0,6-4,8 m<sup>3</sup>/h, H=43-9m, P1 max=1 Kw</p> <p>ART.60122698</p>
	<p><b>1432003</b></p>	<p>UREĐAJ ZA ODRŽAVANJE TLAKA U INSTALACIJI DAB E.SYBOX Q=120 l/min, H max= 60 m, P = 1,55 Kw</p> <p>ART.60147200</p>
	<p><b>1432005</b></p>	<p>UREĐAJ ZA ODRŽAVANJE TLAKA U INSTALACIJI DAB E.SYBOX MINI Q=80 l/min, H max= 55 m, P = 0,84 Kw</p> <p>ART.60163600</p>

# Membranski regulator tlaka

Šifra Vokel	Art.	Ident	DN	PN	G	L	L1	B	H	H1	Sw		
0217048	RT 692	1421521	15	16	1/2"	147	84	67	98	66	30	0,745	6
0217049	RT 693	1431521	20	16	3/4"	155	84	67	98	66	37	0,901	6
0217050	RT 694	1441521	25	16	1"	185	98	67	98	66	46	1,185	6
0217052	RT 695		32	16	1 1/4"	147	84	67	98	66	30	0,745	6
0217053	RT 696		40	16	1 1/2"								
0217054	RT 697		50	16	2"								

T= 0,5°C...40°C

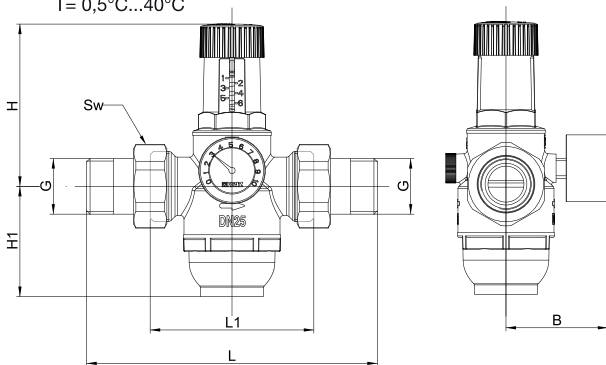

## Namjena:

Membranski regulator tlaka je namijenjen za reguliranje tlaka u vodovodnim i drugim instalacijama, gdje nisu prisutni agresivni i eksplozivni mediji. Izlazni tlak može se podesiti i ne mijenja se s promjenama ulaznog tlaka. Izlazni tlak podeava se okretanjem zelene ručice.



\* Material GRILAMID TP 90





## KPI - TLAČNE SKLOPKE

**Danfoss KPI tlačne sklopke koriste se za regulaciju, nadzor i sustave upozorenja u industrijskim aplikacijama.**

- KPI serija pogodna je za postrojenja u kojima se koriste tekući i plinoviti mediji.
- Raspon tlaka: -0.20 do 8.00 bar
- Tip kontakata: SPDT
- Dostupno s pozlaćenim kontaktima
- Podesivi diferencijal
- Kućište IP44 kod ugradnje s gornjim pokrovom i stražnjom pločom

Š.Vokel

Opis

0683112 TLAČNA SKLOPKA 0,2-8 bar KPI35 ART.55A200-A5A

Tip	KPI35
Naziv proizvođača	DANFOSS
Težina kg	0.313 kg
Temperatura okoline [°C]	-40 – 65 °C
Raspon temperature okoline [°C]	-40 – 65 °C
Primjena s amonijakom	Ne
Funkcija kontakta	SPDT
Nazivna vrijednost kontakta	AC1=10 A, 440 V/8A, 240V
Nazivna vrijednost kontakta	AC15=4 A, 440 V
Nazivna vrijednost kontakta	AC3=6 A, 440 V
Nazivna vrijednost kontakta	DC13=12 W, 220 V
Nazivna vrijednost kontakta	LR max. 50 A
Diferencijal [bar]	0,40 – 1,50 bar
Dimenzije električnog priključka	6-14 mm
Zaštita Kućišta IP	IP30
Maksimalni ispitni tlak [bar]	18,0 bar
Maks. radni tlak [bar]	18,0 bar
Tlačni priključak	G 1/4
Standard tlačnog priključka	ISO 228-1
Priključak Muški/Ženski	Muški
Raspon tlaka	Niskotlačna
Element osjetnika tlaka	Mijeh
Proizvod	Tlačna sklopka
Regulacijsko područje [bar]	-0,20 – 8,00 bar
Reset	AUTO

## Kako naručiti elektromagnetske ventile?

Za kompletan elektromagnetski ventil su potrebni:

- svitak
- kućište ventila
- priključnica



	<b>0683109</b>	SVITAK ZA ELEKTROMAGNETSKI VENTIL 220-230V AC      ART.018F7351
	<b>0683106</b>  <b>0683107</b>  <b>0683108</b>	ELEKTROMAGNETSKI VENTIL EV 250B 12BD 1/2" ZA OTVORENE I ZATVORENE SUSTAVE ZA PLIN I VODU DO 60°C      ART.032U5253  ELEKTROMAGNETSKI VENTIL EV 250B 18BD 3/4" ZA OTVORENE I ZATVORENE SUSTAVE ZA PLIN I VODU DO 60°C      ART.032U5255  ELEKTROMAGNETSKI VENTIL EV 250B 22BD 1" ZA OTVORENE I ZATVORENE SUSTAVE ZA PLIN I VODU DO 60°C      ART.032U5257
	<b>0683110</b>	PRIKLJUČNICA ZA VENTILE - PG 11 24V I 230V      ART.042N0156

	<b>0683113</b>	TERMOSTAT NA DODIR (OSJETNIK TEMPERATURE PODA I PROSTORA) ART.088L0122
	<b>0683105</b>	SOBNI TERMOSTAT TP7001M ART.087N8003
	<b>0683066</b>	OGRANIČAVAČ TEMPERATURE POVRATA RAVNI FJVR 15 ART.003L1014
	<b>0683021</b>	ZIDNI SET ZA PODNO GRIJANJE FHV-R,OKRUGLI BIJELI POKROV ART.003L1000
	<b>0683022</b>	ZIDNI SET ZA PODNO GRIJANJE FHV-R,KVADRATNI BIJELI POKROV ART.003L1006
	<b>0683023</b>	TERMOSTATSKI OSJETNIK FJVR PODEŠAVANJE OD 10-50°C ART.003L1040
	<b>0683024</b>	PRODUŽETAK OD 17,9 mm ZA FJVR VENTILE ART.003L1036
	<b>0683067</b>	MJEŠAJUĆI SKLOP ZA PODNO GRIJANJE FHM-C5 ART.088U0084
	<b>0683068</b>	MJEŠAJUĆI SKLOP ZA PODNO GRIJANJE FHM-C6 ART.088U0085
	<b>0683069</b>	TERMOSTATSKI MJEŠAJUĆI VENTIL 30-70°, TVM-H DN 20,G 1" A ART.003Z1120
	<b>0683070</b>	TERMOSTATSKI MJEŠAJUĆI VENTIL 30-70°, TVM-H DN 25,G 1 1/4"A ART.003Z1127
	<b>0683020</b>	REGULATOR ZA SOLARNI SUSTAV SA DVA TEMPERATurna OSJETNIKA SH-E01 ART.088H2001



**MJEŠAČ C MIX M100**

- Snaga: 1.010 W/230 V
- Max. Ø mješača: 120 mm/HEXAFIX
- Opterećenje vrtnje: 630 min<sup>-1</sup>

VOKEL ŠIFRA	OPIS	SNAGA (W)	ARTIKAL
<b>0727057</b>	MJEŠAČ C MIX M1000 (WK120HF)	1010	20360

**MJEŠAČ C MIX M1400**

- Snaga: 1.400 W/230 V
- Max. Ø mješača: 140 mm/HEXAFIX
- Opterećenje vrtnje: 400/620 min<sup>-1</sup>

VOKEL ŠIFRA	OPIS	SNAGA (W)	ARTIKAL
<b>0727058</b>	MJEŠAČ C MIX M1400 (WK140HF)	1400	20370

**MJEŠAČ X01 M**

- Snaga: 1.010 W/230 V
- Max. Ø mješača: 120 mm/HEXAFIX
- Opterećenje vrtnje: 630 min<sup>-1</sup>

VOKEL ŠIFRA	OPIS	SNAGA (W)	ARTIKAL
<b>0727067</b>	MJEŠAČ X01 M (WK 120M)	1010	20406

**HEXAFIX**
**ADAPTER**

VOKEL ŠIFRA	OPIS	ARTIKAL
<b>0727059</b>	ADAPTER HEXAFIX (BRZA SPOJKA)	49517-000



WK

MJEŠALO

VOKEL ŠIFRA	OPIS	ARTIKAL
<b>0727060</b>	MJEŠALO WK120HF	40112-000
<b>0727061</b>	MJEŠALO WK140HF	40113-000



KR

MJEŠALO

VOKEL ŠIFRA	OPIS	ARTIKAL
<b>0727062</b>	MJEŠALO KR120HF	40120-000
<b>0727063</b>	MJEŠALO KR140HF	40121-000



MK

MJEŠALO

VOKEL ŠIFRA	OPIS	ARTIKAL
<b>0727064</b>	MJEŠALO MK120HF	40114-000
<b>0727065</b>	MJEŠALO MK140HF	40115-000



FM

MJEŠALO

VOKEL ŠIFRA	OPIS	ARTIKAL
<b>0727066</b>	MJEŠALO FM120HF	40102-000

**LAJSNA KUTNA PVC L=270 cm**

<b>23042</b>	BEŽ	RE/8/100	ART.80151/100
<b>23054</b>	PASTELNO PLAVA	RE/8/100	ART.80141/100
<b>23244</b>	TAMNO SIVA	RE/8/100	ART.80117/100
<b>23041</b>	PEPELASTO SIVA	RE/8/100	ART.80121/100
<b>23328</b>	SVIJETLO SIVA	RE/8/100	ART.80125/100
<b>23039</b>	BIJELA	RE/8/100	ART.80101/100
<b>23104</b>	CRNA	RE/8/100	ART.80133/100
<b>23083</b>	SMEĐA	RE/8/100	ART.80169/100
<b>23338</b>	TAMNO SMEĐA	RE/8/100	ART.80173/100
<b>23279</b>	ROZA	RE/8/100	ART.80145/100
<b>23280</b>	CAMEL	RE/8/100	ART.80165/100
<b>23281</b>	JASMIN	RE/8/100	ART.80109/100
<b>23290</b>	ŽUTA	RE/8/100	ART.80137/100
<b>23295</b>	CRVENA	RE/8/100	ART.80129/100
<b>23300</b>	PLAVA-MODRA	RE/8/100	ART.80161/100
<b>23322</b>	KREM	RE/8/100	ART.80105/100
<b>23334</b>	BRESKVA	RE/8/100	ART.80155/100



**ČEP ZA PVC LAJSNE**

<b>23110</b>	BIJELI	TE/8/50	ART.80401
<b>23111</b>	SVIJETLO SIVA	TE/8/50	ART.80421
<b>23112</b>	BEŽ	TE/8/50	ART.80449
<b>23136</b>	PASTELNO PLAVI	TE/8/50	ART.80441
<b>23140</b>	CRNI	TE/8/50	ART.80433
<b>23297</b>	CAMELLO	TE/8/50	ART.80459
<b>23298</b>	MARRON	TE/8/50	ART.80463
<b>23291</b>	CRVENI	TE/8/50	ART.80429
<b>23292</b>	ŽUTI	TE/8/50	ART.80437
<b>23293</b>	ROZI	TE/8/50	ART.80445
<b>23294</b>	JASMIN	TE/8/50	ART.80409
<b>0994272</b>	BRESKVA	TE/8/50	ART.80453
<b>0994273</b>	SMEĐI	TE/8/50	ART.80467
<b>23179</b>	BIJELI	TE/10/50	ART.80402
<b>23180</b>	SVIJETLO SIVI	TE/10/50	ART.80422
<b>23181</b>	BEŽ	TE/10/50	ART.80450
<b>0994268</b>	JASMIN	TE/10/50	ART.80410
<b>23266</b>	BIJELI	TE/12/50	ART.80403
<b>0994362</b>	MAT-BAKAR	TBRS/10	ART.92770

<b>0994269</b>	CRNA	RE/10/100	ART.80134/100
<b>23175</b>	BIJELA	RE/10/100	ART.80102/100
<b>23245</b>	TAMNO SIVA	RE/10/100	ART.80118/100
<b>23176</b>	PEPELASTO SIVA	RE/10/100	ART.80122/100
<b>23329</b>	SVIJETLO SIVA	RE/10/100	ART.80126/100
<b>23177</b>	BEŽ	RE/10/100	ART.80152/100
<b>23323</b>	KREM	RE/10/100	ART.80106/100
<b>23324</b>	JASMIN	RE/10/100	ART.80110/100
<b>23330</b>	CRVENA	RE/10/100	ART.80130/100
<b>23335</b>	BRESKVA	RE/10/100	ART.80156/100
<b>23336</b>	CAMEL	RE/10/100	ART.80166/100
<b>23339</b>	TAMNO SMEĐA	RE/10/100	ART.80174/100
<b>23212</b>	BIJELA	RE/12/100	ART.80103/100

**LAJSNA KUTNA ALUMINIJ L=270 cm**

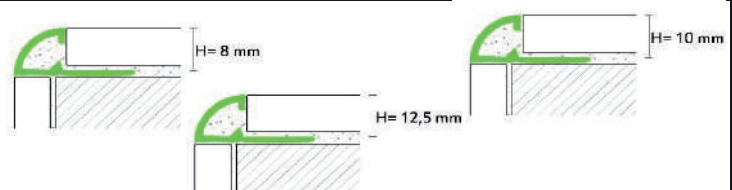
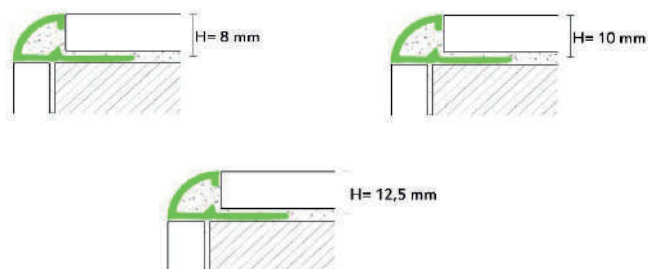
<b>23022</b>	ALUMINIJ-BIJELA	RV/8	ART.92102
<b>23037</b>	KROMIRANA	RB/8	ART.92312
<b>23036</b>	ZLATNA	RB/8	ART.92342
<b>23216</b>	KROMIRANA	RB/10	ART.92314
<b>23265</b>	ALUMINIJ ZLATNA	RB/10	ART.92344
<b>23282</b>	KROM MATIRANA	RA/8	ART.92072
<b>0994216</b>	KROM MATIRANA	RA/10	ART.92076
<b>23275</b>	ALUMINIJ- MAT	RA/10	ART.92074
<b>0994361</b>	MAT-BAKAR	RBRS/10	ART.92306



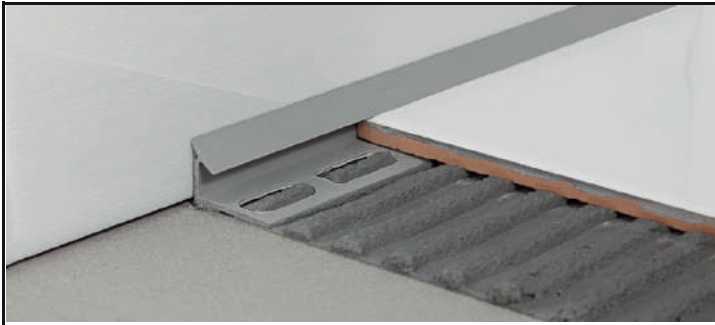

**LAJSNA UNUTARNJI KUT PVC L=270 cm**

<b>23130</b>	BIJELA	PI/9	ART.95402
<b>23132</b>	BEŽ	PI/9	ART.95410
<b>23173</b>	SIVA	PI/9	ART.95414

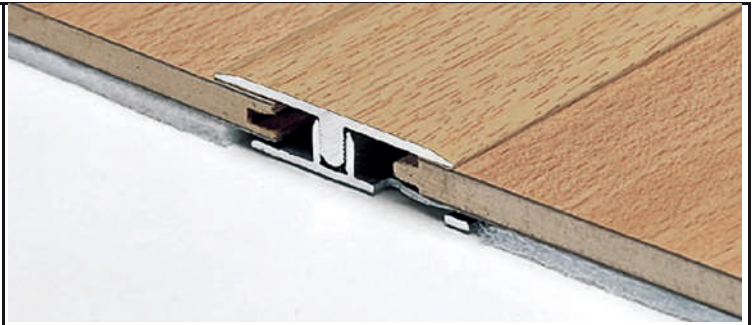
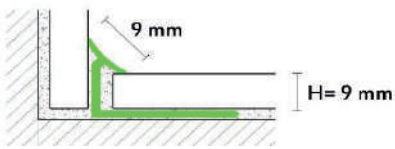

**T-LAJNSNA ALUMINIJ L=270 cm**

<b>23099</b>	ZLATNA	Z/1/SF	ART.67227
<b>23100</b>	SREBRNA	Z/1/SF	ART.67217

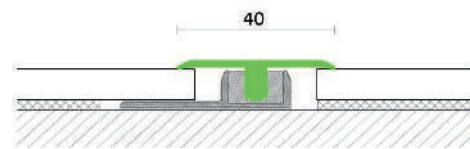

**T-LAJNSNA MESING L=270 mm**

<b>23043</b>	MESING 14 mm	399/T	ART.75087
<b>23215</b>	KROMIRANA 14 mm	399/TC	ART.75086
<b>23105</b>	MESING 26 mm	399/T26	ART.75088
<b>23134</b>	KROMIRANA 26 mm	399/T26C	ART.75089
<b>0994256</b>	MESING 14 mm L=90 cm	4399/T	ART.20016
<b>0994257</b>	ALUMINIJ 14 mm L=90 cm	499/T	ART.20008

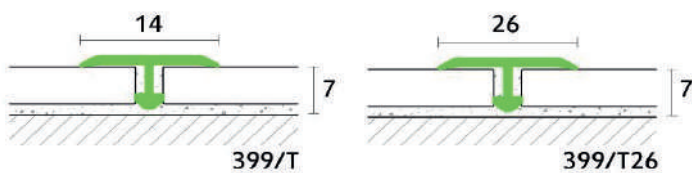

**TE-LAJNSNA BOJA DRVETA L=270 cm**

<b>23277</b>	BOJA DRVETA BR.40	Z2/20/SF	ART.63630
--------------	-------------------	----------	-----------

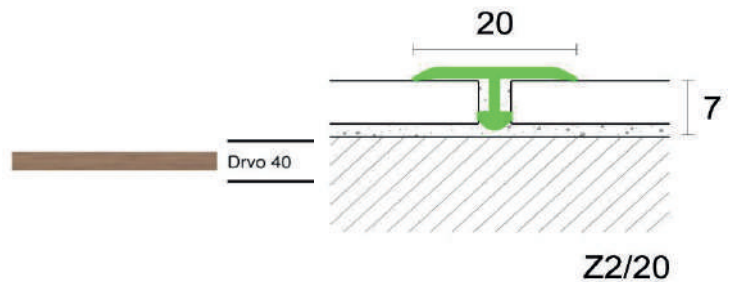

**TE-LAJNSNA BOJA DRVETA L=270 cm**

<b>23278</b>	BOJA DRVETA BR.50	Z3/30/SF	ART.63740
--------------	-------------------	----------	-----------

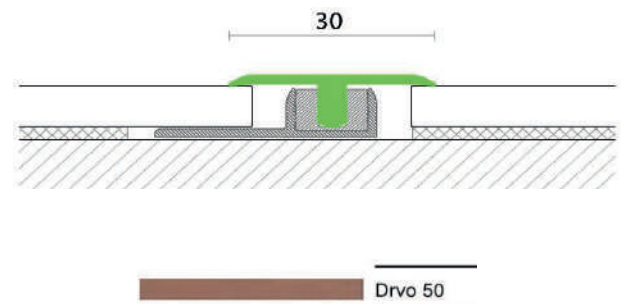





**TE-LAJSNA INOX L=270 cm**

- |                |                       |         |           |
|----------------|-----------------------|---------|-----------|
| <b>23276</b>   | ČELIK INOX 26 mm      | 799/T26 | ART.75096 |
| <b>0994253</b> | ČELIK INOX 14 mm L=90 | 4799/T  | ART.20001 |



**LAJSNA ZA RAZDVAJANJE I DEKORACIJU L=270 cm**

- |                |                     |       |           |
|----------------|---------------------|-------|-----------|
| <b>0994221</b> | ČELIK INOX 10x10 mm | 799/U | ART.75078 |
|----------------|---------------------|-------|-----------|

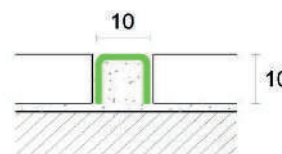

**LAJSNA ZA RAZDVAJANJE L=270 cm**

- |                |                 |         |           |
|----------------|-----------------|---------|-----------|
| <b>0994254</b> | ČELIČNA H=8 mm  | AIS/80  | ART.91674 |
| <b>0994255</b> | ČELIČNA H=10 mm | AIS/100 | ART.91675 |

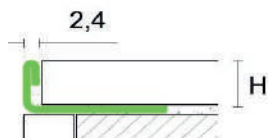

**LAJSNA ZA RAZDVAJANJE-SAVITLJIVA L=270 cm**

- |                |                     |         |           |
|----------------|---------------------|---------|-----------|
| <b>0994258</b> | ALUMINIJSKA H=8 mm  | ZGF/80  | ART.88723 |
| <b>0994259</b> | ALUMINIJSKA H=10 mm | ZGF/100 | ART.88724 |

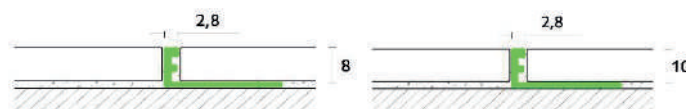

**LAJSNA ZA RAZDVAJANJE L=270 cm**

- |              |                  |        |           |
|--------------|------------------|--------|-----------|
| <b>23102</b> | MESING H=8 mm    | DN/80  | ART.91620 |
| <b>23145</b> | MESING H=10 mm   | DN/100 | ART.91622 |
| <b>23103</b> | MESING H=12,5 mm | DN/125 | ART.95624 |

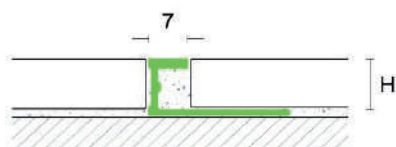

**LAJSNA ZA STEPENICE L=270 cm**

- |              |                  |        |           |
|--------------|------------------|--------|-----------|
| <b>23107</b> | MESING H=8 mm    | SN/80  | ART.93991 |
| <b>23178</b> | MESING H=10 mm   | SN/100 | ART.93922 |
| <b>23139</b> | MESING H=12,5 mm | SN/125 | ART.93993 |

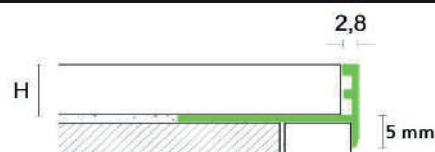

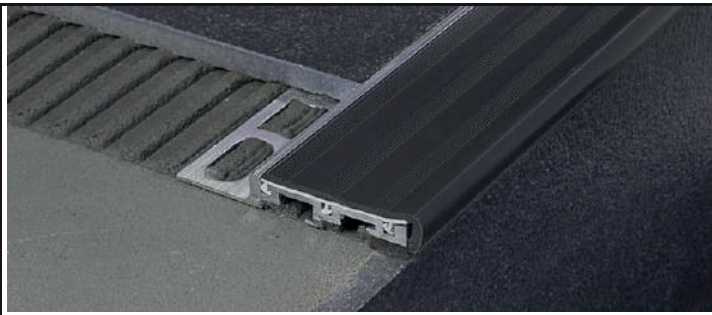

**LAJSNA ZA STEPENICE SA CRNOM GUMOM L=270 cm**

- |              |           |          |           |
|--------------|-----------|----------|-----------|
| <b>23092</b> | H=10 mm   | SA/100/2 | ART.94081 |
| <b>23135</b> | H=12,5 mm | SA/125/2 | ART.94141 |



**LAJSNA KUTNA PLASTIČNA L= 270 cm**

- |              |                      |         |           |
|--------------|----------------------|---------|-----------|
| <b>23146</b> | BIJELA SAMOLJEPLJIVA | BP/20/A | ART.95470 |
| <b>23147</b> | BIJELA               | BP20    | ART.95490 |

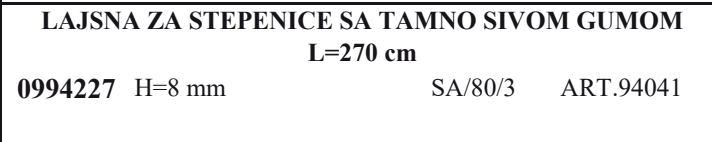

**LAJSNA ZA STEPENICE SA TAMNO SIVOM GUMOM L=270 cm**

- |                |        |         |           |
|----------------|--------|---------|-----------|
| <b>0994227</b> | H=8 mm | SA/80/3 | ART.94041 |
|----------------|--------|---------|-----------|

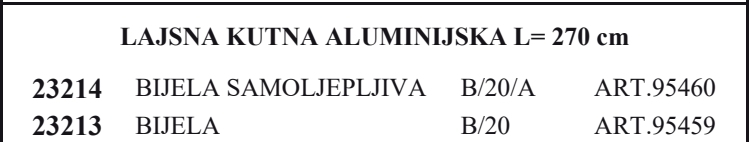

**LAJSNA KUTNA ALUMINIJSKA L= 270 cm**

- |              |                      |        |           |
|--------------|----------------------|--------|-----------|
| <b>23214</b> | BIJELA SAMOLJEPLJIVA | B/20/A | ART.95460 |
| <b>23213</b> | BIJELA               | B/20   | ART.95459 |

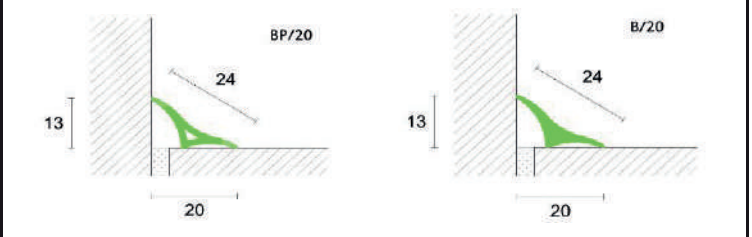
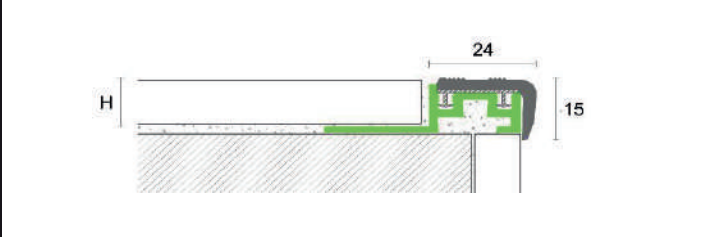

**PVC KUTNA LAJSNA ZA KADE L=270 cm**

- |              |        |       |           |
|--------------|--------|-------|-----------|
| <b>23285</b> | BIJELA | BP/25 | ART.95540 |
|--------------|--------|-------|-----------|



**PVC KUTNA LAJSNA ZA KADE L=270 cm**

- |              |        |       |           |
|--------------|--------|-------|-----------|
| <b>23283</b> | BIJELA | BP/22 | ART.95520 |
|--------------|--------|-------|-----------|

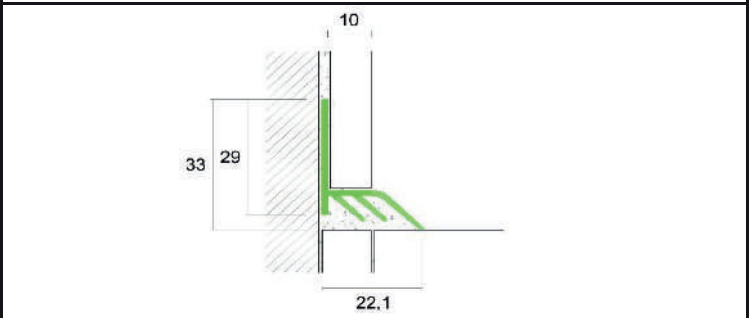
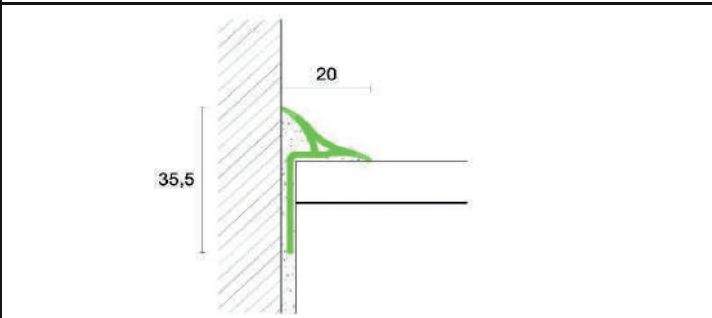





**ALUMINIJSKA LAJSNA PLOSNATA L=270 cm**

<b>23067</b>	ALUMINIJ-ZLATNA	27/ST	ART.69014
<b>23066</b>	ALUMINIJ-SREBRNA	27/ST	ART.69006
<b>23069</b>	BOJA DRVETA 40	27/ST	ART.70024



**ALUMINIJSKA LAJSNA PLOSNATA L=270 cm**

<b>0994242</b>	ZLATNA 93 cm	427/CT	ART.41008
<b>0994243</b>	BOJA DRVETA 20 93 cm	427/CT	ART.45357
<b>0994244</b>	BOJA DRVETA 40 93 cm	427/CT	ART.45367

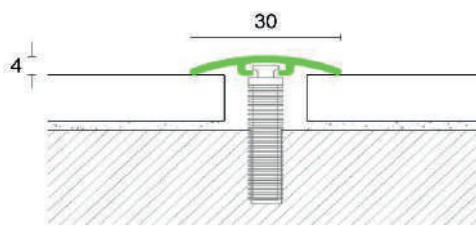
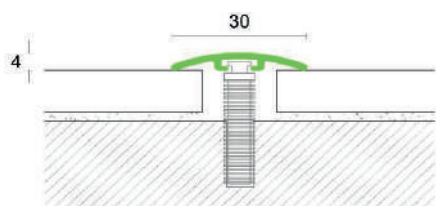

**ALUMINIJSKA LAJSNA ZA RAZLIČITE VISINE L=270 cm**

<b>23116</b>	BOJA DRVETA 40	28/ST	ART.70282
<b>23113</b>	ZLATNA	28/ST	ART.69254
<b>0994237</b>	SREBRENA 40 mm	29/ST	ART.69142
<b>0994238</b>	ZLATNA 40 mm	29/ST	ART.69150
<b>0994239</b>	BOJA DRVETA 40 40 mm	29/ST	ART.70136
<b>0994245</b>	SREBRENA L=93 cm	429/CT	ART.41202
<b>0994246</b>	ZLATNA L=93 cm	429/CT	ART.41208

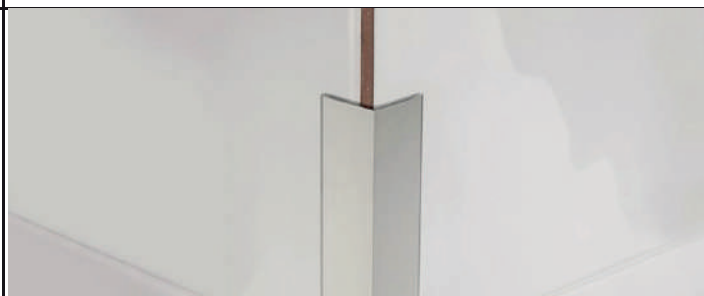

**LAJSNA KUTNA 20x20 L=270 cm**

<b>23073</b>	MESING-SJAJNA	077/SF	ART.76728
<b>23074</b>	ČELIK INOX	777/SF	ART.76898

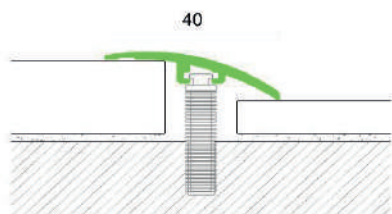
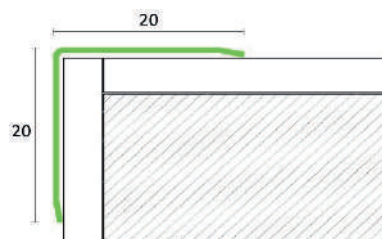



**ALUMINIJSKA LAJSNA DEKORATIVNA L=270 cm**

<b>0994217</b>	ALUMINIJ KROM 10 mm LA/B	ART.93252
<b>0994332</b>	ALUMINIJ ZLATO 10 mm LA/B	ART.93253
<b>0994218</b>	ALUMINIJ KROM 25 mm LB/B	ART.93272

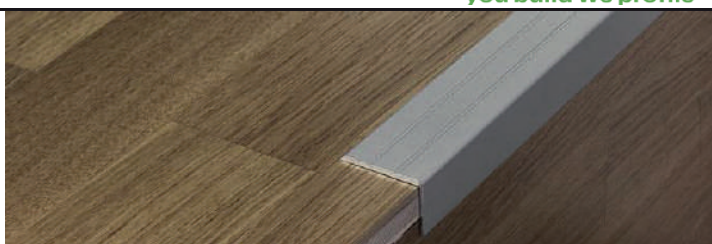

**SAMOLJEPLJIVA ALUMINIJSKA LAJSNA ZA STEPENICE-PLOSNATA L=270 cm**

<b>0994251</b>	ZLATNA	74/A	ART.95298
<b>0994252</b>	BRONZA	74/A	ART.95318

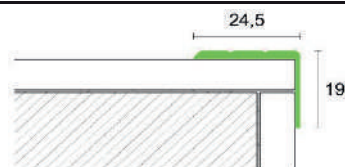
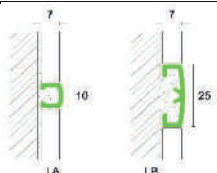

**ALUMINIJSKA LAJSNA ZA STEPENICE L=270 cm**

<b>0994212</b>	SREBRENA	73/F	ART.75208
<b>0994213</b>	ZLATNA	73/F	ART.75218
<b>0994215</b>	ZLATNA	53/SF	ART.75204

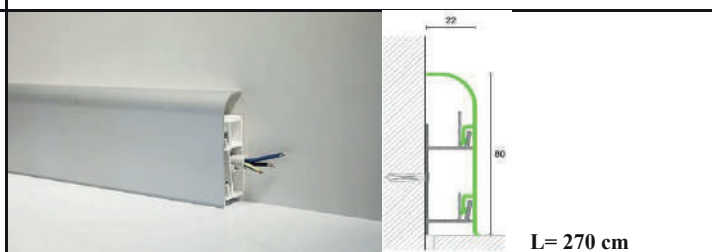

<b>0994231</b>	ALU.COKLO S 3 NOSAČA	97/8SF	ART.78010
<b>0994232</b>	VANJSKI KUT	97/8E	ART.78210
<b>0994233</b>	UNUTARNJI KUT	97/8I	ART.78211
<b>0994234</b>	RAVNI PVC SPOJ	97/8G	ART.78212
<b>0994235</b>	ČEPOVI PVC	97/8P	ART.78213

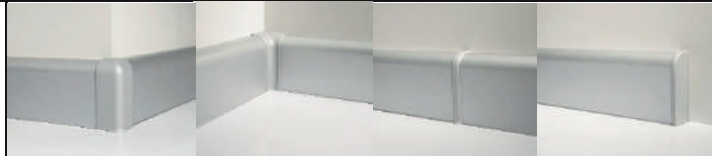
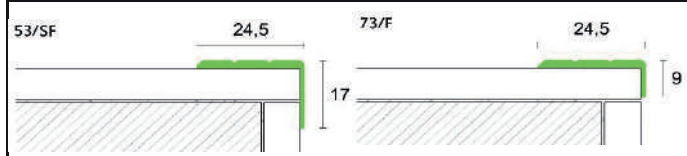

**SAMOLJEPIVA ALUMINIJSKA LAJSNA ZA SPOJEVE-PLOSNATA L=270 cm**

<b>0994249</b>	SREBRENA	19/A	ART.71897
<b>0994250</b>	ZLATNA	19/A	ART.71907



**LAJSNA ZA FUGE L=270 cm**

<b>23048</b>	MESING H=10 mm	399/R10	ART.75007
<b>23070</b>	MESING 7 mm	380/7	ART.75037

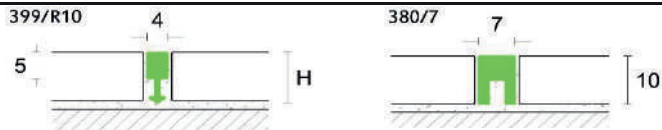



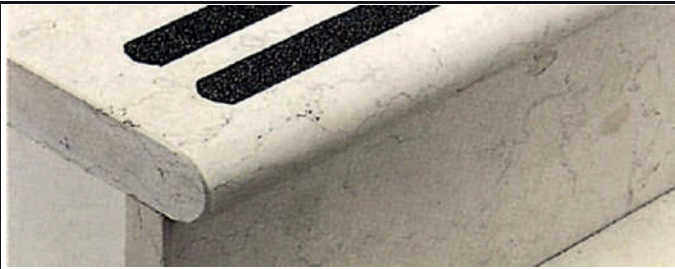

**PROTUKLIZNA TRAKA ZA STEPENICE 19 mm L=18,2 m**

<b>23031</b>	CRNA	ART.23002
<b>23033</b>	SMEĐA	ART.23062
<b>23272</b>	PROZIRNA	ART.23018



**LAJSNA ZA DILATACIJU L=270 cm**

<b>0994260</b>	SIVO-SIVO H= 8 mm	NL/80	ART.99700
<b>23174</b>	SIVO-SIVO H= 10 mm	NL/100	ART.99710
<b>0994276</b>	SIVO-SIVO H= 12,5 mm	NL/125	ART.99720

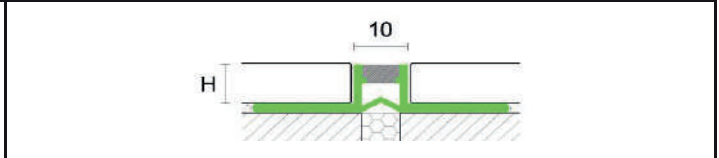

**PODLOŽNA LAJSNA L=270 cm**

<b>23101</b>	ALUMINIJ	T/7/F	ART.67287
--------------	----------	-------	-----------

Od 6,5mm do 9,5 mm

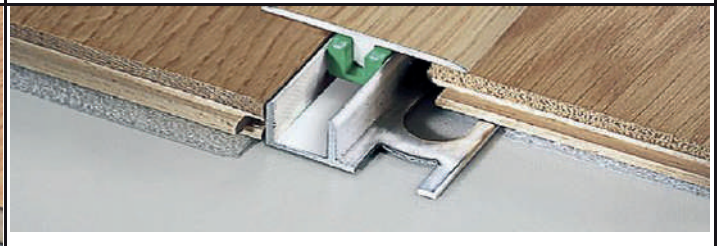

**PODLOŽNA ALUMINIJSKA LAJSNA ZA STEPENICE L=270 cm**

<b>0994405</b>	ALUMINIJ SREBRENA	TPU/6	ART.67437
<b>23220</b>	ALUMINIJ SREBRENA	TPU/10	ART.67447



Unisystem Plus baza uključuje 15 umetaka TU/7

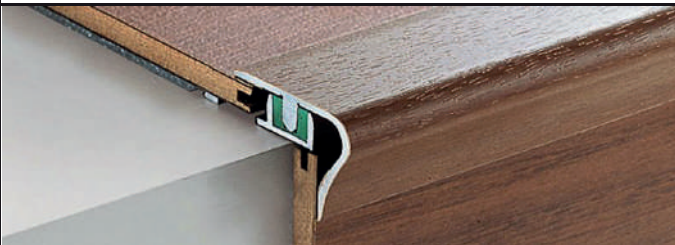

**ALUMINIJSKA LAJSNA ZA STEPENICE L=270 cm**

<b>23217</b>	ALUMINIJ SREBRENA	G/4/SF	ART.63900
<b>23218</b>	ALU.BOJA DRVETA 10	G/4/SF	ART.63910
<b>0994230</b>	ALU.BOJA DRVETA 20	G/4/SF	ART.63915
<b>23219</b>	ALU.BOJA DRVETA 40	G/4/SF	ART.63920
<b>0994229</b>	PJEŠČANO ZLATNA	G/4/SF	ART.63904

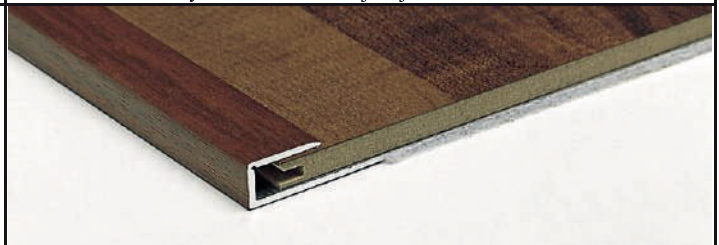
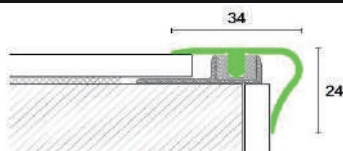

**ALUMINIJSKA LAJSNA ZA LAMINAT-ZAVRŠNA L=270 cm**

<b>0994208</b>	ZLATNA	RC/7	ART.67417
<b>0994209</b>	SREBRENA	RC/7	ART.67407
<b>0994210</b>	ALU.BOJA DRVETA 40	RC/7	ART.66710
<b>0994211</b>	ALU.BOJA DRVETA 60	RC/7	ART.66716
<b>0994406</b>	ANODIZIRANO SREBRO	RC/9/F	ART.67477
<b>0994407</b>	ANODIZIRANO SREBRO	RC/11/F	ART.67547



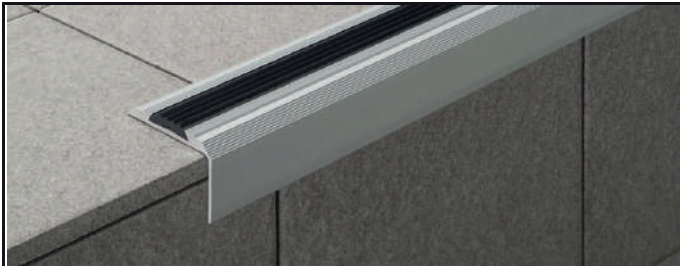

**Lajsna za stepenice L=340 cm**

- |              |                            |      |           |
|--------------|----------------------------|------|-----------|
| <b>23058</b> | ALUMINIJ SREBRENA          | 72/F | ART.75508 |
| <b>23057</b> | ALUMINIJ ZLATNA            | 72/F | ART.75518 |
| <b>23059</b> | GUMA ZA LAJSNE SMEĐA GM/72 |      | ART.75569 |

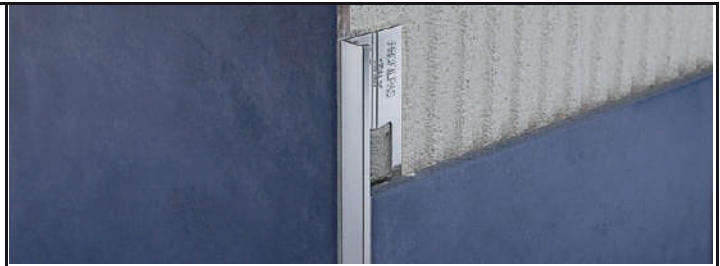

**Kutna aluminijaska lajsna L=270 cm**

- |                |                   |        |           |
|----------------|-------------------|--------|-----------|
| <b>0994219</b> | SREBRENA H= 8 mm  | ZA/80  | ART.88205 |
| <b>0994220</b> | SREBRENA H= 10 mm | ZA/100 | ART.88206 |

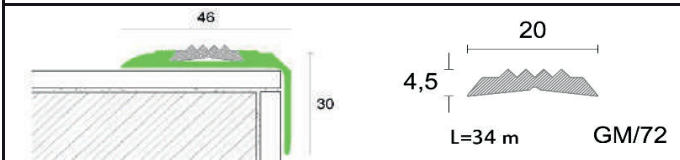

**ALUMINIJSKA LAJSNA ZA BALKONE I TERASE L=270 cm**

- |                |                    |          |           |
|----------------|--------------------|----------|-----------|
| <b>0994294</b> | LAJSNA OBODNA H=12 | CPHA/125 | ART.87601 |
|----------------|--------------------|----------|-----------|



**KAJLE ZA KERAMIKU**

- |              |  |      |           |
|--------------|--|------|-----------|
| <b>23060</b> | KAJLE ZA KERAMIKU 1-5 mm 250/1 L=9mm H=5mm | CN28 | ART.19080 |
|--------------|--|------|-----------|

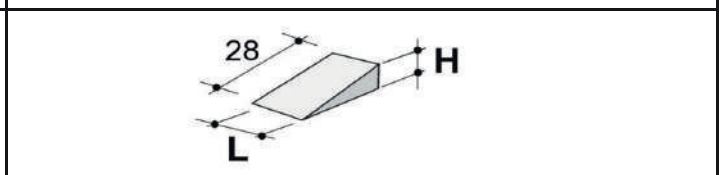
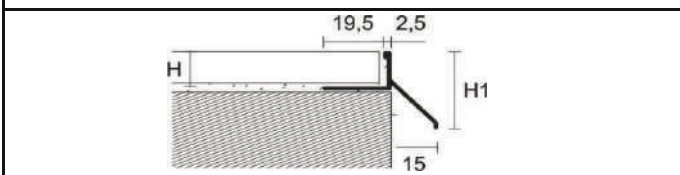

**KRIŽIĆI ZA POSTAVLJANJE KERAMIKE**

- |                |                            |           |
|----------------|----------------------------|-----------|
| <b>0994282</b> | KRIŽIĆI PUNI 1 mm 500/1    | ART.18992 |
| <b>23108</b>   | KRIŽIĆI PUNI 2mm 500/1     | ART.19002 |
| <b>23001</b>   | KRIŽIĆI PUNI 2mm 250/1     | ART.19000 |
| <b>23097</b>   | KRIŽIĆI ŠUPLJI 3mm 500/1   | ART.19008 |
| <b>12980</b>   | KRIŽIĆI PUNI 4mm 250/1     | ART.18006 |
| <b>23098</b>   | KRIŽIĆI ŠUPLJI 5mm 500/1   | ART.19020 |
| <b>11176</b>   | KRIŽIĆI ŠUPLJI 7mm 1000/1  | ART.19026 |
| <b>0994279</b> | KRIŽIĆI ŠUPLJI 10 mm 500/1 | ART.19032 |



**T - KRIŽIĆI ZA POSTAVLJANJE KERAMIKE**

- |                |                      |           |
|----------------|----------------------|-----------|
| <b>23248</b>   | T-KRIŽIĆI 2 mm 250/1 | ART.19040 |
| <b>0994278</b> | T-KRIŽIĆI 2 mm 500/1 | ART.19042 |
| <b>23249</b>   | T-KRIŽIĆI 3 mm 250/1 | ART.19046 |
| <b>23250</b>   | T-KRIŽIĆI 5 mm 250/1 | ART.19058 |



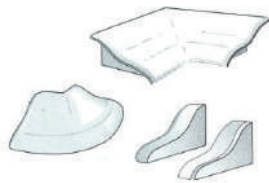

### ČEPOVI ZA KUTNE LAJSNE

<b>23148</b>	SET ČEPOVA	BPT/20	ART.95480
<b>23284</b>	SET ČEPOVA	BPT/22	ART.95530
<b>23286</b>	SET ČEPOVA	BPT/25	ART.95545



### ČEPOVI ZA LAJSNE

<b>0994295</b>	ČEP ZA LAJSNE ALU-MAT TA/8	ART.92608
<b>0994280</b>	ČEP ZA LAJSNE ALU-MAT TA/10	ART.92610
<b>0994281</b>	ČEP ZA LAJSNE ALU-MAT TA/12	ART.92612
<b>23143</b>	ČEP ZA LAJSNE KROM TB/8/50	ART.92692
<b>23340</b>	ČEP ZA LAJSNE ZLATNI TB/8/50	ART.92702
<b>23341</b>	ČEP ZA LAJSNE KROM TB/10/50	ART.92694
<b>23342</b>	ČEP ZA LAJSNE ZLATNI TB/10/50	ART.92704

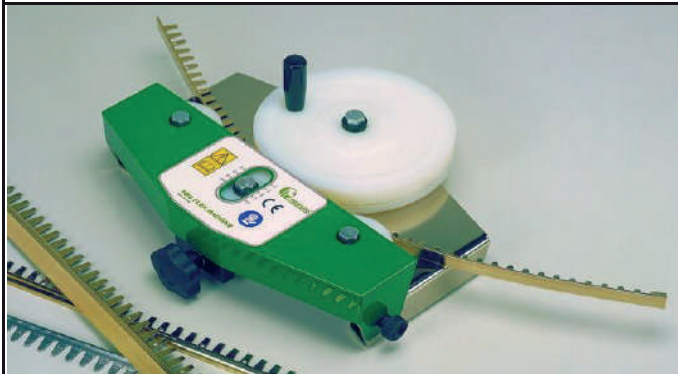

### STROJ ZA SAVIJANJE LAJSNI

<b>23138</b>	STROJ ZA SAVIJANJE LAJSNI	ART.30022
--------------	---------------------------	-----------



### PVC VIJCI ZA LAJSNE

<b>23114</b>	VIJAK 29 mm	T/29/200	ART.68900
<b>23115</b>	VIJAK 29 mm	T/38/100	ART.68901

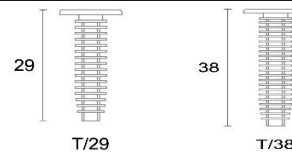



**TE-LAJSNA L=270 cm**

<b>0994222</b>	ALUMINIJ L=14 mm	99/T	ART.75080
<b>0994223</b>	ALUMINIJ L=26 mm	99/T26	ART.75082

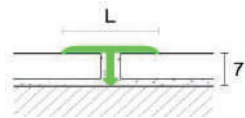

**LAJSNA ZA STEPENICE L=270 cm**

<b>23223</b>	MESING	SGL/110	ART.94977
--------------	--------	---------	-----------

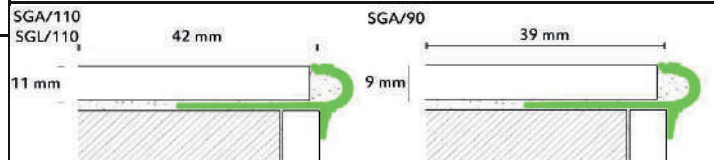

**LAJSNA KUTNA PVC L=270 cm**

<b>0994284</b>	BIJELA	ZQP/100/10	ART.80802
<b>0994285</b>	SVIJETLO SIVA	ZQP/100/10	ART.80822
<b>0994286</b>	KAMENO SIVA	ZQP/100/10	ART.80818
<b>0994287</b>	ANTRACITE	ZQP/100/10	ART.80826
<b>0994288</b>	BOJA BJELOKOSTI	ZQP/100/10	ART.80810
<b>0994289</b>	PRLJAVO BIJELA	ZQP/100/10	ART.80806
<b>0994290</b>	BEŽ	ZQP/100/10	ART.80834
<b>0994291</b>	BEŽ SIVO	ZQP/100/10	ART.80814
<b>0994292</b>	PASTELNO PLAVA	ZQP/100/10	ART.80830

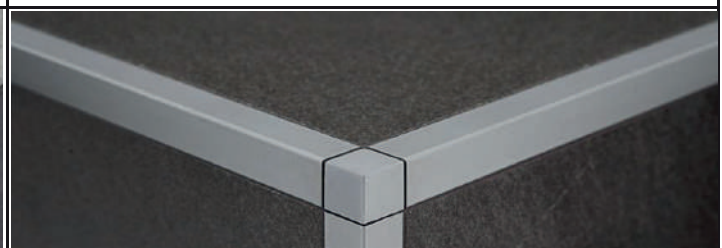

**ČEP ZA PVC LAJSNE**

<b>0994296</b>	BIJELA	ZQP/100/50	ART.80852
<b>0994297</b>	CREMA	ZQP/100/50	ART.80856
<b>0994298</b>	BOJA BJELOKOSTI	ZQP/100/50	ART.80860
<b>0994299</b>	BEŽ	ZQP/100/50	ART.80864
<b>0994300</b>	KAMENO SIVA	ZQP/100/50	ART.80868
<b>0994301</b>	SVIJETLO SIVA	ZQP/100/50	ART.80872
<b>0994302</b>	ANTRACITE	ZQP/100/50	ART.80876
<b>0994303</b>	PASTELNO PLAVA	ZQP/100/50	ART.80880
<b>0994304</b>	BEŽ SIVO	ZQP/100/50	ART.80884



**INOX LAJSNA ZA UNUTARNJU STRANU TUŠA L=148 cm**

<b>0994411</b>	INOX LAJSNA SX	GPS3/SX/10	ART.31677
<b>0994410</b>	INOX LAJSNA DX	GPS3/DX/10	ART.31675

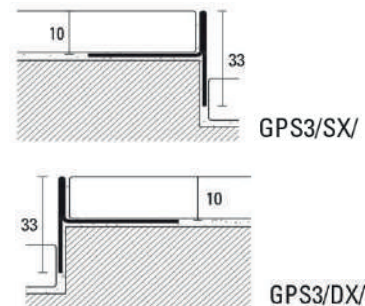





**LAJSNA KUTNA ALUMINIJSKA ČETVRTASTA L=270 cm**

<b>0994345</b>	PLATINUM	ZQAND/10	ART.31112
<b>0994346</b>	TITANIUM	ZQAND/10	ART.31122
<b>0994347</b>	SMEĐA	ZQAND/10	ART.31132
<b>0994348</b>	ELOKS.SREBRO	ZQAN/10	ART.88878
<b>0994349</b>	ELOKS.SREBRO	ZQAN/12,5	ART.88880
<b>0994350</b>	SJAJ.SREBRO	ZQBN/10	ART.88922
<b>0994351</b>	SJAJ.SREBRO	ZQBN/12,5	ART.88924
<b>0994352</b>	IZBRAZD.SREBRO	ZQAGN/10	ART.89065

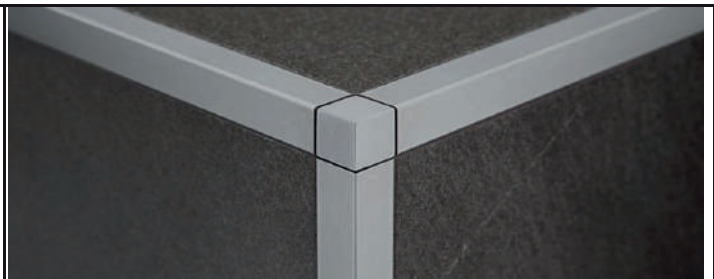
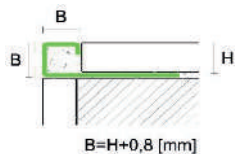

**ČEP ZA ALUMINIJSKE LAJSNE ČETVRTASTI**

<b>0994353</b>	PLATINUM	ZQAND/10/EI	ART.31162
<b>0994354</b>	SMEĐI	ZQAND/10/EI	ART.31182
<b>0994355</b>	TAMNO SMEĐI	ZQAND/10/EI	ART.31192
<b>0994356</b>	ELOKS.SREBRO	ZQAN/10/EI	ART.88885
<b>0994357</b>	ELOKS.SREBRO	ZQAN/12,5/EI	ART.88887
<b>0994358</b>	SJAJ.SREBRO	ZQBN/10/EI	ART.88929
<b>0994359</b>	SJAJ.SREBRO	ZQBN/12,5/EI	ART.88931
<b>0994360</b>	IZBRAZD.SREBRO	ZQAGN/10/EI	ART.89073

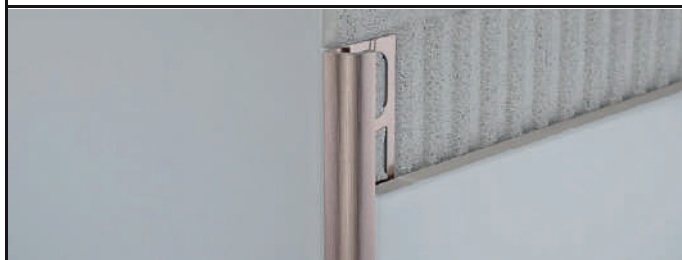

**LAJSNA KUTNA ALUMINIJSKA ZAOBLJENA L=270 cm**

<b>0994361</b>	MAT -BAKRENA	RBRBS/10	ART.92306
----------------	--------------	----------	-----------



**ČEP ZA ALUMINIJSKE LAJSNE ZAOBLJENI**

<b>0994362</b>	MAT -BAKRENI	TBRBS/10	ART.92770
----------------	--------------	----------	-----------



**DEKORATIVNA LAJSNA ALUMINIJSKA 25x7 cm L=270 cm**

<b>0994363</b>	PLATINUM	LDAD	ART.31320
<b>0994364</b>	SMEĐA	LDAD	ART.31324
<b>0994365</b>	TAMNO SMEĐA	LDAD	ART.31326



**DEKORATIVNA LAJSNA ALUMINIJSKA 20x7 cm L=270 cm**

<b>0994366</b>	IZBRAZDANA SREBRNA	LDAG/20x7	ART.93228
----------------	--------------------	-----------	-----------

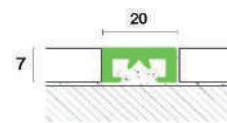



**TE-LAJSNA 14 mm L=270 cm**

**0994222** ANODIZIRANO 99/T/14 ART.75080  
SREBRO

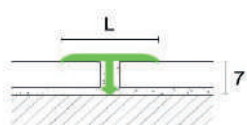

**LAJSNA ZA RAZLIČITE VISINE L= 270 cm**

**0994368** ANODIZIRANO PBA/12,5 ART.93208  
SREBRO

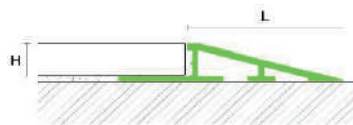

**LAJSNA ZA STEPENICE L=270 cm**

**0994032** ANODIZIRANO SGA/11 ART.94967  
SREBRO

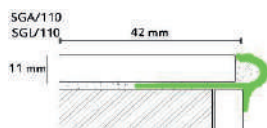

**PRELAZNA LAJSNA ZA RAZLIČITE VISINE L= 270 cm**

**0994344** ALUMINIJSKA h=8 mm PA/8 ART.93181  
**0994342** ALUMINIJSKA h=10 mm PA/10 ART.93182  
**0994343** ALUMINIJSKA h=12 mm PA/12 ART.93183



**ALUMINIJSKO COKLO 60 mm L=270 cm**

**0994367** ANODIZIRANO 90/6 SF ART.78100  
SREBRO

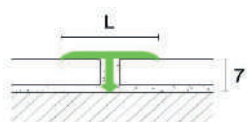

**0994370** UNUTARNJI KUT 6 cm 90/6 I ART.78190  
**0994369** VANJSKI KUT 6 cm 90/6 E ART.78191  
**0994371** SPOJNICA 6 cm 90/6 G ART.78192  
**0994372** ČEP 6 cm 90/6 P ART.78193





**TUŠ KANALICA 60 cm BAZA + REŠETKA RAVNA**  
**0994373** NEHRĐAJUĆI ČELIK DIN.1.4301 SLIM/60 cm ART.19504



**REŠETKA ZA TUŠ KANALICU 60 cm**  
**0994374** INOX SATINIRANI XSC/60 ART.19524  
**0994375** INOX GLATKI XSC/60 ART.19523



**T-LAJSNA ALUMINIJ 40 mm L=270 cm**

<b>23099</b>	ZLATNA	Z/1/SF	ART.67227
<b>23100</b>	SREBRNA	Z/1/SF	ART.67217
<b>0994376</b>	BOJA DRVETA 12	Z/1/SF	ART.66309
<b>0994377</b>	BOJA DRVETA 40	Z/1/SF	ART.66337
<b>0994378</b>	BOJA DRVETA 65	Z/1/SF	ART.66365
<b>0994379</b>	BOJA DRVETA 76	Z/1/SF	ART.66374



**T-LAJSNA ZA RAZLIČITE VISINE ALUMINIJ 40 mm L=270 cm**

<b>0994380</b>	ZLATNA	C/7/SF	ART.67017
<b>0994381</b>	SREBRNA	C/7/SF	ART.67007
<b>0994382</b>	BOJA DRVETA 12	C/7/SF	ART.66009
<b>0994383</b>	BOJA DRVETA 40	C/7/SF	ART.66037
<b>0994384</b>	BOJA DRVETA 65	C/7/SF	ART.66065
<b>0994385</b>	BOJA DRVETA 76	C/7/SF	ART.66074
<b>0994386</b>	BOJA DRVETA 80	C/7/SF	ART.66077
<b>0994387</b>	BOJA DRVETA 90	C/7/SF	ART.66087



**ZAVRŠNA LAJSNA ALUMINIJ 32 mm L=270 cm**  
**0994392** SREBRNA S/9/SF ART.65680

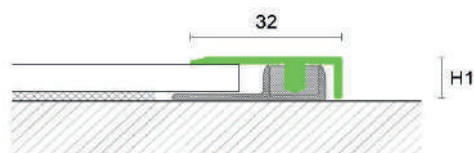

**T-LAJSNA ZA RAZLIČITE VISINE ALUMINIJ 45 mm L=270 cm**

<b>0994388</b>	BOJA DRVETA 08	C/10/SF	ART.66104
<b>0994389</b>	BOJA DRVETA 40	C/10/SF	ART.66137
<b>0994390</b>	BOJA DRVETA 65	C/10/SF	ART.66165
<b>0994391</b>	BOJA DRVETA 76	C/10/SF	ART.66182

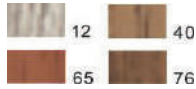

**PVC COKLO 70 mm L=250 cm**

<b>0994393</b>	BIJELA	8608	ART.29070
<b>0994394</b>	BOJA DRVETA 12	8608	ART.29045
<b>0994395</b>	BOJA DRVETA 40	8608	ART.29051
<b>0994396</b>	BOJA DRVETA 76	8608	ART.29060

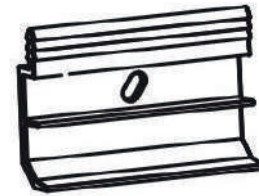

**PROFIL ZA MONTAŽU COKLA NA ZID**

<b>0994397</b>	PROFIL	8608/C	ART.29751
----------------	--------	--------	-----------



**ZAVRŠNA LAJSNA ALUMINIJ 21 mm L=270 cm**

<b>0994398</b>	ANODIZIRANO SREBRO	Z/4	ART.85050
----------------	--------------------	-----	-----------



**T-LAJNSNA ALUMINIJ L=270 cm**

<b>0994399</b>	ANODIZIRANO SREBRO	C/4	ART.85060
----------------	--------------------	-----	-----------

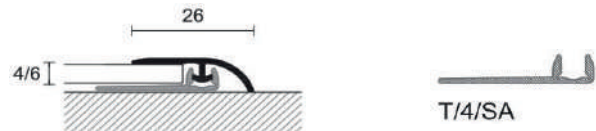

**ALUMINIJSKA LAJSNA ZA RAZLIČITE VISINE L=270 cm**

<b>0994400</b>	ANODIZIRANO SREBRO	C/4	ART.85070
----------------	--------------------	-----	-----------

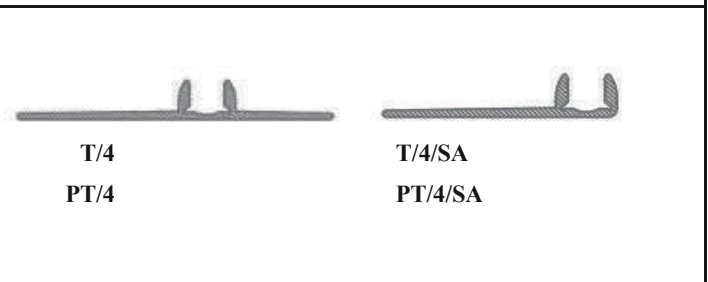

**PODLOŽNE LAJSNE L=270 cm**

<b>0994401</b>	ALUMINIJ	T/4	ART.85080
<b>0994402</b>	ALUMINIJ	T/4/SA	ART.85082
<b>0994408</b>	PVC ZELENA	PT/4	ART.85081
<b>0994409</b>	PVC ZELENA	PT/4/SA	ART.85083

**SERIJA 1.**

- Alumijski profili za zaštitu vanjskih kutova zidnih obloga.
- Preporučuje se upotreba u vrlo prolaznim prostorima, ili gdje postoji opasnost da se prilikom prolaženja oštete rubovi obloge.
- Dostupne su u tri boje: zlatna, srebrena, bronca i antracit.

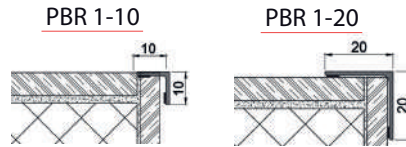

VOKEL ŠIFRA	OPIS	BOJA	DIMENZIJA (m)	ARTIKAL
<b>1330058</b>	PBR ALUMINIJSKA LAJSNA PBR 1-10	SREBRENA	2,70	121008
<b>1330076</b>	PBR ALUMINIJSKA LAJSNA PBR 1-10	ANTRACIT	2,70	121062
<b>1330028</b>	PBR ALUMINIJSKA LAJSNA PBR 1-20	SREBRENA	2,70	121011
<b>1330068</b>	PBR ALUMINIJSKA LAJSNA PBR 1-20	BRONČANA	2,70	121010
<b>1330077</b>	PBR ALUMINIJSKA LAJSNA PBR 1-20	ANTRACIT	2,70	121069

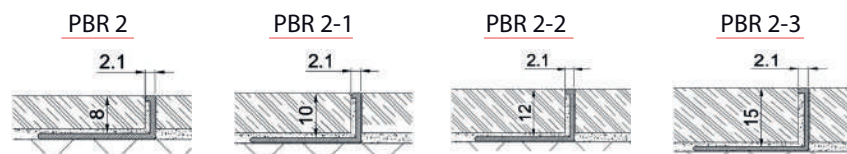

**SERIJA 2.**

- Alumijski profili za dilataciju i zaštitu vanjskih kutova.
- Dostupne su u pet boja: zlatna, srebrena, bronca, bijela i antracit



VOKEL ŠIFRA	OPIS	BOJA	DEBLJINA (mm)	DUŽINA (m)	ARTIKAL
<b>1330042</b>	ALUMINIJSKA LAJSNA PBR-2	ZLATNA	8	2,70	121084
<b>1330001</b>	ALUMINIJSKA LAJSNA PBR-2	SREBRENA	8	2,70	121085
<b>1330002</b>	ALUMINIJSKA LAJSNA PBR-2	BRONČANA	8	2,70	121086
<b>1330047</b>	ALUMINIJSKA LAJSNA PBR-2	BIJELA	8	2,70	121210
<b>1330050</b>	ALUMINIJSKA LAJSNA PBR-2	ANTRACIT	8	2,70	121213
<b>1330056</b>	ALUMINIJSKA LAJSNA PBR 2-1	ZLATNA	10	2,70	121079
<b>1330019</b>	ALUMINIJSKA LAJSNA PBR 2-1	SREBRENA	10	2,70	121078
<b>1330020</b>	ALUMINIJSKA LAJSNA PBR 2-1	BRONČANA	10	2,70	121098
<b>1330048</b>	ALUMINIJSKA LAJSNA PBR 2-1	BIJELA	10	2,70	121169
<b>1330051</b>	ALUMINIJSKA LAJSNA PBR 2-1	ANTRACIT	10	2,70	121211
<b>1330069</b>	ALUMINIJSKA LAJSNA PBR 2-2	ZLATNA	12	2,70	121088
<b>1330021</b>	ALUMINIJSKA LAJSNA PBR 2-2	SREBRENA	12	2,70	121077
<b>1330022</b>	ALUMINIJSKA LAJSNA PBR 2-2	BRONČANA	12	2,70	121087
<b>1330049</b>	ALUMINIJSKA LAJSNA PBR 2-2	BIJELA	12	2,70	121168
<b>1330052</b>	ALUMINIJSKA LAJSNA PBR 2-2	ANTRACIT	12	2,70	121212
<b>1330029</b>	ALUMINIJSKA LAJSNA PBR 2-3	SREBRENA	15	2,70	121106
<b>1330040</b>	ALUMINIJSKA LAJSNA PBR 2-3	BRONČANA	15	2,70	121115

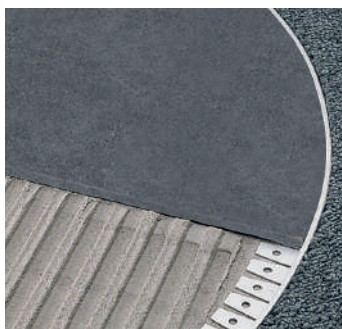

**SERIJA 2 - savitljiva**

- Aluminijski profili za dilataciju i zaštitu vanjskih kutova - savitljivi.
- Idealan je u funkciji razdjelnica podova od različitih materijala, primjerice keramike i tepiha.
- Dostupne su u tri boje: zlatna, srebrna, bronca

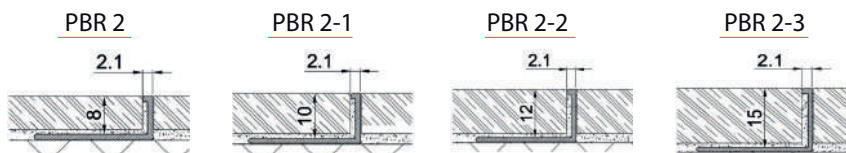

VOKEL ŠIFRA	OPIS	BOJA	DEBLJINA (mm)	DUŽINA (m)	ARTIKAL
<b>1330034</b>	ALUMINIJSKA LAJSNA PBR 2-1	SREBRENA	10	2,70	121145

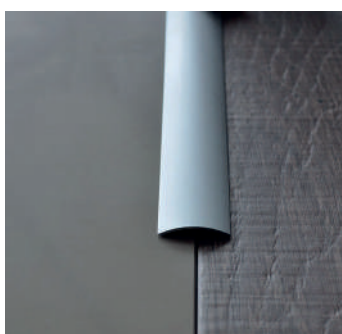
**SERIJA 3.**

- Aluminijski profili za podove istih visina.
- Idealan za skrivanje spojeva od različitih materijala.
- Dostupne su u tri boje: zlatna, srebrna i bronca.

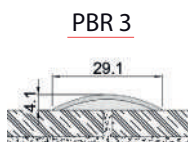

VOKEL ŠIFRA	OPIS	BOJA	DIMENZIJA (m)	ARTIKAL
<b>1330070</b>	ALUMINIJSKA LAJSNA PBR-3	SREBRENA	2,70	121032

**SERIJA 4.**

- Aluminijski profili za podove istih ili različitih visina.
- Dostupne su u tri boje: zlatna, srebrna i bronca.



VOKEL ŠIFRA	OPIS	BOJA	DIMENZIJA (m)	ARTIKAL
<b>1330060</b>	ALUMINIJSKA LAJSNA PBR-4	SREBRENA	2,70	121073
<b>1330061</b>	ALUMINIJSKA LAJSNA PBR-4	BRONČANA	2,70	121089
<b>1330071</b>	ALUMINIJSKA LAJSNA PBR-4	ZLATNA	2,70	121074
<b>1330067</b>	ALUMINIJSKA LAJSNA PBR-8-1 NOSAČ	SREBRENA	2,50	121040

**SERIJA 5.**

- Aluminijski profili za podove istih visina.
- Idealan je za prikrivanje nekih nedostataka koji su posljedica rezanja ili polaganja među podovima od različitih materijala
- Dostupne su u tri boje: zlatna, srebrna, bronca i antracit.

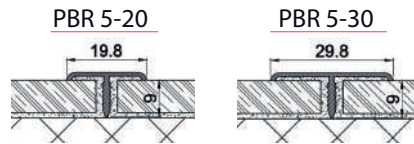

VOKEL ŠIFRA	OPIS	BOJA	ŠIRINA (mm)	DUŽINA (m)	ARTIKAL
<b>1330004</b>	ALUMINIJSKA LAJSNA PBR-5-20	SREBRENA	20	2,70	121014
<b>1330003</b>	ALUMINIJSKA LAJSNA PBR-5-20	BRONČANA	20	2,70	121013
<b>1330005</b>	ALUMINIJSKA LAJSNA PBR-5-20	ZLATNA	20	2,70	121015
<b>1330080</b>	ALUMINIJSKA LAJSNA PBR-5-20	ANTRACIT	20	2,70	121066
<b>1330035</b>	ALUMINIJSKA LAJSNA PBR-5-30	SREBRENA	30	2,70	121017
<b>1330036</b>	ALUMINIJSKA LAJSNA PBR-5-30	ZLATNA	30	2,70	121018
<b>1330081</b>	ALUMINIJSKA LAJSNA PBR-5-30	ANTRACIT	30	2,70	121214

**SERIJA 6.**

- Aluminijski profil za stepenice
- Dostupne su u tri boje: zlatna, srebrna, bronca i antracit.

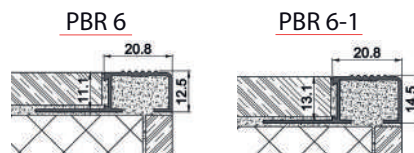

VOKEL ŠIFRA	OPIS	BOJA	DEBLJINA (mm)	DUŽINA (m)	ARTIKAL
<b>1330006</b>	ALUMINIJSKA LAJSNA PBR 6	SREBRENA	10	2,50	121127
<b>1330078</b>	ALUMINIJSKA LAJSNA PBR 6	ANTRACIT	10	2,50	121116
<b>1330073</b>	ALUMINIJSKA LAJSNA PBR 6-1	BRONČANA	10	2,50	121128
<b>1330043</b>	ALUMINIJSKA LAJSNA PBR 6-1	SREBRENA	8	2,50	121021
<b>1330041</b>	ALUMINIJSKA LAJSNA PBR 6-1	SREBRENA	14	2,50	-
<b>1330079</b>	ALUMINIJSKA LAJSNA PBR 6-1	ANTRACIT	14	2,50	121191

**SERIJA 7.**

- Aluminijski profil za stepenice koji se također koristi kao i okapnica za balkone
- Dostupne su u tri boje: zlatna, srebrna i bronca

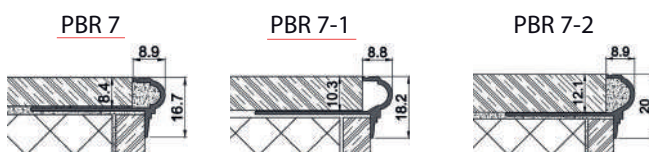

VOKEL ŠIFRA	OPIS	BOJA	DEBLJINA (mm)	DUŽINA (m)	ARTIKAL
<b>1330027</b>	ALUMINIJSKA LAJSNA PBR 7	ZLATNA	8	2,50	121029
<b>1330026</b>	ALUMINIJSKA LAJSNA PBR 7	SREBRENA	8	2,50	121028
<b>1330007</b>	ALUMINIJSKA LAJSNA PBR 7-1	ZLATNA	10	2,50	121006
<b>1330008</b>	ALUMINIJSKA LAJSNA PBR 7-1	SREBRENA	10	2,50	121026
<b>1330009</b>	ALUMINIJSKA LAJSNA PBR 7-1	BRONČANA	10	2,50	121027
<b>1330012</b>	ALUMINIJSKA LAJSNA PBR 7-2	ZLATNA	12	2,50	121082
<b>1330010</b>	ALUMINIJSKA LAJSNA PBR 7-2	SREBRENA	12	2,50	121080
<b>1330011</b>	ALUMINIJSKA LAJSNA PBR 7-2	BRONČANA	12	2,50	121081

**SERIJA 9.**

- Aluminijski cikl profil za prikrivanje kablova
- Dostupne su u tri boje: zlatna, srebrna i bronca



PBR 9

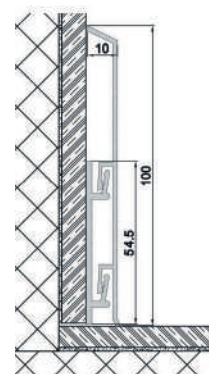

VOKEL ŠIFRA	OPIS	BOJA	VISINA (mm)	DUŽINA (m)	ARTIKAL
<b>1330038</b>	ALUMINIJSKA LAJSNA PBR 9	SREBRENA	100	3,00	121071
<b>1330039</b>	NOSAČ LAJSNE PBR 9-1	SREBRENA	-	-	121046
<b>1330062</b>	PVC SPOJNICA 9	SREBRENA	-	-	122624
<b>1330063</b>	PVC 9 UNUTARNJI KUT	SREBRENA	-	-	122621
<b>1330064</b>	PVC 9 VANJSKI KUT	SREBRENA	-	-	122618
<b>1330065</b>	PVC 9 LIJEVA ZAVRŠNA KAPA	SREBRENA	-	-	122627
<b>1330066</b>	PVC 9 DESNA ZAVRŠNA KAPA	SREBRENA	-	-	122628

**SERIJA 11.**

- Aluminijski profil za zatvaranje i zaštitu vanjskih kutova zidnih keramičkih obloga pomoću kojeg se izbjegavaju neestetski i krhki rezovi pod kutem od 45°, zaobljeni oblik daje istovremeno simetrični izgled i djeluje kao zaštita za kut obloge.
- Dostupne su u tri boje: zlatna, srebrna i bronca

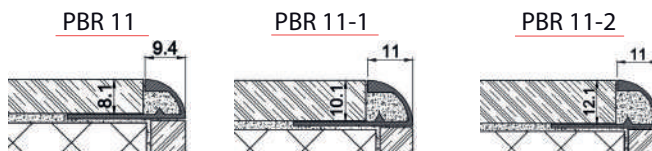

VOKEL ŠIFRA	OPIS	BOJA	DEBLJINA (mm)	DUŽINA (m)	ARTIKAL
<b>1330023</b>	ALUMINIJSKA LAJSNA PBR 11	SREBRENA	8	2,70	121022
<b>1330024</b>	ALUMINIJSKA LAJSNA PBR 11-1	SREBRENA	10	2,70	121024
<b>1330059</b>	ALUMINIJSKA LAJSNA PBR 11-1	BRONČANA	10	2,70	121025
<b>1330025</b>	ALUMINIJSKA LAJSNA PBR 11-2	SREBRENA	12	2,70	121090

**SERIJA 12.**

- Aluminijski profil za zatvaranje i zaštitu vanjskih zidnih keramičkih kutova, također se koristi kao i okapnica za balkone
- Dostupne su u tri boje: zlatna, srebrna i bronca

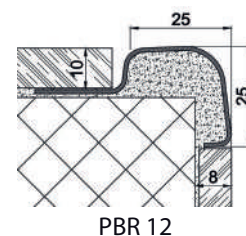

VOKEL ŠIFRA	OPIS	BOJA	DEBLJINA (mm)	DUŽINA (m)	ARTIKAL
<b>1330037</b>	ALUMINIJSKA LAJSNA PBR 12	SREBRENA	10	2,70	121048

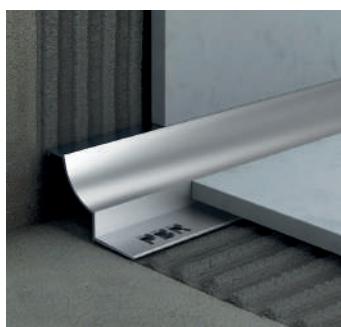
**SERIJA 13.**

- Aluminijski profil za unutarnje kutove
- Dostupne su u tri boje: zlatna, srebrna i bronca

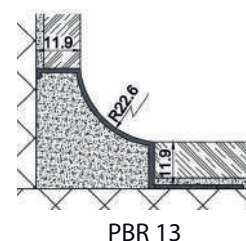

VOKEL ŠIFRA	OPIS	BOJA	DUŽINA (m)	ARTIKAL
<b>1330033</b>	ALUMINIJSKA LAJSNA PBR 13	SREBRENA	2,70	121052



**SERIJA 14.**

- Aluminijski profil za podove različitih visina
- Dostupne su u tri boje: zlatna, srebrna i bronca

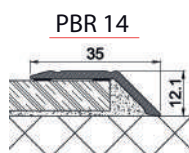

VOKEL ŠIFRA	OPIS	BOJA	DUŽINA (m)	ARTIKAL
<b>1330057</b>	ALUMINIJSKA LAJSNA PBR 14	BRONČANA	2,70	121110

**SERIJA 16.**

- Aluminijski profil za zatvaranje i zaštitu vanjskih kutova keramičkih obloga čijim se četvrtastim oblikom definira položena obloga i tako izbjegava neestetski i krhki rez pod kutom od 45° na rubovima pločica
- Također se koristi za dilataciju kao i bordura na zidnim oblogama
- Dostupne su u tri boje: zlatna, srebrna i bronca



VOKEL ŠIFRA	OPIS	BOJA	DEBLJINA (mm)	DUŽINA (m)	ARTIKAL
<b>1330030</b>	ALUMINIJSKA LAJSNA PBR 16-1	SREBRENA	10	2,70	121104
<b>1330031</b>	ALUMINIJSKA LAJSNA PBR 16-2	SREBRENA	12,5	2,70	121105

**SERIJA 17.**

- Aluminijski profil za okapnice balkona
- Dostupne su u tri boje: zlatna, srebrna, bronca i antracit.

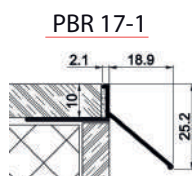

VOKEL ŠIFRA	OPIS	BOJA	DEBLJINA (mm)	DUŽINA (m)	ARTIKAL
<b>1330032</b>	ALUMINIJSKA LAJSNA PBR 17-1	SREBRENA	10	2,70	121151
<b>1330055</b>	ALUMINIJSKA LAJSNA PBR 17-1	BRONČANA	10	2,70	121152
<b>1330075</b>	ALUMINIJSKA LAJSNA PBR 17-1	ANTRACIT	10	2,70	121060



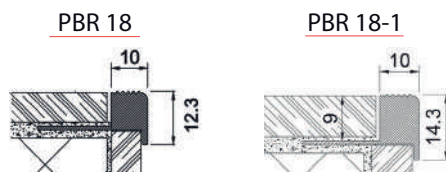

**SERIJA 18.**

- Aluminijski puni profil za stepenice
- Dostupne su u tri boje: zlatna, srebrna i bronca

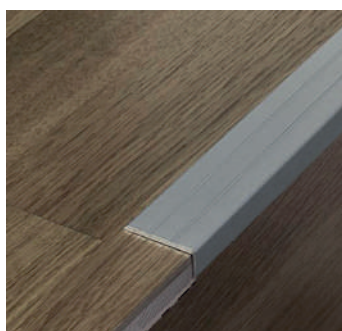

VOKEL ŠIFRA	OPIS	BOJA	DEBLJINA (mm)	DUŽINA (m)	ARTIKAL
<b>1330044</b>	ALUMINIJSKA LAJSNA PBR 18	SREBRENA	7	2,60	121165
<b>1330045</b>	ALUMINIJSKA LAJSNA PBR 18-1	SREBRENA	9	2,60	121163
<b>1330072</b>	ALUMINIJSKA LAJSNA PBR 18-1	BRONČANA	9	2,60	121176

**SERIJA 19.**

- Aluminijski završni profil za laminare i parkete
- Dostupne su u tri boje: zlatna, srebrna i bronca

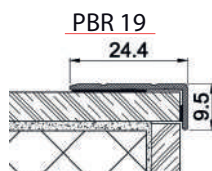

VOKEL ŠIFRA	OPIS	BOJA	ŠIRINA (mm)	DUŽINA (m)	ARTIKAL
<b>1330013</b>	ALUMINIJSKA LAJSNA PBR 19	ZLATNA	24,4	2,70	121034
<b>1330014</b>	ALUMINIJSKA LAJSNA PBR 19	SREBRENA	24,4	2,70	121035
<b>1330015</b>	ALUMINIJSKA LAJSNA PBR 19	BRONČANA	24,4	2,70	121036

**SERIJA 20.**

- Aluminijski završni profil za laminare i parkete
- Dostupne su u tri boje: zlatna, srebrna i bronca

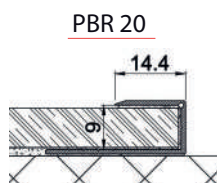

VOKEL ŠIFRA	OPIS	BOJA	DEBLJINA (mm)	DUŽINA (m)	ARTIKAL
<b>1330016</b>	ALUMINIJSKA LAJSNA PBR 20	ZLATNA	9	2,70	121043
<b>1330017</b>	ALUMINIJSKA LAJSNA PBR 20	SREBRENA	9	2,70	121057
<b>1330018</b>	ALUMINIJSKA LAJSNA PBR 20	BRONČANA	9	2,70	121058

**SERIJA 21.**

- Aluminijski profil za zaštitu vanjskih kutova
- Dostupne su u tri boje: zlatna, srebrna i bronca

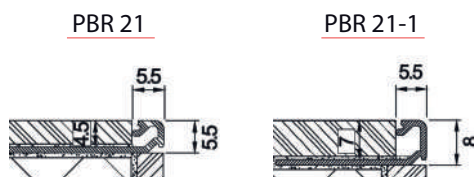

VOKEL ŠIFRA	OPIS	BOJA	DEBLJINA (mm)	DUŽINA (m)	ARTIKAL
<b>1330046</b>	ALUMINIJSKA LAJSNA PBR 21	SREBRENA	4,5	2,70	121178
<b>1330053</b>	ALUMINIJSKA LAJSNA PBR 21-1	SREBRENA	7	2,70	121181
<b>1330054</b>	ALUMINIJSKA LAJSNA PBR 21-1	BRONČANA	7	2,70	121182

**SERIJA 22.**

- Aluminijski profil za zaštitu vanjskih kutova
- Dostupne boje: antracit.

PBR 22-1-2-SR



VOKEL ŠIFRA	OPIS	BOJA	DEBLJINA (mm)	DUŽINA (m)	ARTIKAL
<b>1330082</b>	ALUMINIJSKA LAJSNA PBR 22-1-2-SR	SREBRENA	4,5	2,70	121184

	ŠIFRA VOKEL	Opis.	Stjenka deb.	Ø promj.	PAKOVANJE/ PAKET/m	JED. MJ.
	<b>0726001</b>	Cijevna izolacija EV IT-FLEX L=2 m	9	15	192	m
	<b>0726002</b>	Cijevna izolacija EV IT-FLEX L=2 m	9	18	166	m
	<b>0726003</b>	Cijevna izolacija EV IT-FLEX L=2 m	9	22	136	m
	<b>0726004</b>	Cijevna izolacija EV IT-FLEX L=2 m	9	28	98	m
	<b>0726005</b>	Cijevna izolacija EV IT-FLEX L=2 m	9	35	76	m
	<b>0726006</b>	Cijevna izolacija EV IT-FLEX L=2 m	9	42	60	m
	<b>0726007</b>	Cijevna izolacija EV IT-FLEX L=2 m	9	48	50	m
	<b>0726008</b>	Cijevna izolacija EV IT-FLEX L=2 m	9	54	46	m
	<b>0726009</b>	Cijevna izolacija EV IT-FLEX L=2 m	9	60	46	m
	<b>0726010</b>	Cijevna izolacija EV IT-FLEX L=2 m	9	76	40	m
	<b>0726011</b>	Cijevna izolacija EV IT-FLEX L=2 m	9	89	36	m
	<b>0726012</b>	Cijevna izolacija EV IT-FLEX L=2 m	9	102	22	m
	<b>0726013</b>	Cijevna izolacija EV IT-FLEX L=2 m	9	108	22	m
	<b>0726014</b>	Cijevna izolacija EV IT-FLEX L=2 m	9	114	22	m
	<b>0726015</b>	Cijevna izolacija EV IT-FLEX L=2 m	13	15	136	m
	<b>0726016</b>	Cijevna izolacija EV IT-FLEX L=2 m	13	18	118	m
	<b>0726017</b>	Cijevna izolacija EV IT-FLEX L=2 m	13	22	98	m
	<b>0726018</b>	Cijevna izolacija EV IT-FLEX L=2 m	13	28	78	m
	<b>0726019</b>	Cijevna izolacija EV IT-FLEX L=2 m	13	35	58	m
	<b>0726020</b>	Cijevna izolacija EV IT-FLEX L=2 m	13	42	48	m
	<b>0726021</b>	Cijevna izolacija EV IT-FLEX L=2 m	13	48	40	m
	<b>0726022</b>	Cijevna izolacija EV IT-FLEX L=2 m	13	54	34	m
	<b>0726023</b>	Cijevna izolacija EV IT-FLEX L=2 m	13	60	32	m
	<b>0726024</b>	Cijevna izolacija EV IT-FLEX L=2 m	13	76	26	m
	<b>0726025</b>	Cijevna izolacija EV IT-FLEX L=2 m	13	89	24	m
	<b>0726026</b>	Cijevna izolacija EV IT-FLEX L=2 m	13	102	16	m
	<b>0726027</b>	Cijevna izolacija EV IT-FLEX L=2 m	13	108	16	m
	<b>0726050</b>	Cijevna izolacija EV IT-FLEX L=2 m	13	114	16	m
	<b>0726028</b>	Cijevna izolacija EV IT-FLEX L=2 m	19	15	78	m
	<b>0726029</b>	Cijevna izolacija EV IT-FLEX L=2 m	19	18	72	m
	<b>0726030</b>	Cijevna izolacija EV IT-FLEX L=2 m	19	22	64	m
	<b>0726031</b>	Cijevna izolacija EV IT-FLEX L=2 m	19	28	48	m
	<b>0726032</b>	Cijevna izolacija EV IT-FLEX L=2 m	19	35	36	m
	<b>0726033</b>	Cijevna izolacija EV IT-FLEX L=2 m	19	42	32	m
<b>0726034</b>	Cijevna izolacija EV IT-FLEX L=2 m	19	48	24	m	
<b>0726035</b>	Cijevna izolacija EV IT-FLEX L=2 m	19	54	24	m	
<b>0726036</b>	Cijevna izolacija EV IT-FLEX L=2 m	19	60	22	m	
<b>0726037</b>	Cijevna izolacija EV IT-FLEX L=2 m	19	76	18	m	
<b>0726038</b>	Cijevna izolacija EV IT-FLEX L=2 m	19	89	14	m	
<b>0726039</b>	Cijevna izolacija EV IT-FLEX L=2 m	19	102	14	m	
<b>0726040</b>	Cijevna izolacija EV IT-FLEX L=2 m	19	108	12	m	
<b>0726051</b>	Cijevna izolacija EV IT-FLEX L=2 m	19	114	12	m	

	ŠIFRA VOKEL	Opis.	Stjenka deb.	jed.mj.	PAKOVANJE/ m <sup>2</sup>
	<b>0726041</b>	Izolacija u ploči EV IT-FLEX	6	m <sup>2</sup>	30
	<b>0726042</b>	Izolacija u ploči EV IT-FLEX	10	m <sup>2</sup>	20
	<b>0726043</b>	Izolacija u ploči EV IT-FLEX	13	m <sup>2</sup>	14
	<b>0726044</b>	Izolacija u ploči EV IT-FLEX	19	m <sup>2</sup>	10
	<b>0726045</b>	Izolacija u ploči EV IT-FLEX samoljepljiva	6	m <sup>2</sup>	30
	<b>0726046</b>	Izolacija u ploči EV IT-FLEX samoljepljiva	10	m <sup>2</sup>	20
	<b>0726047</b>	Izolacija u ploči EV IT-FLEX samoljepljiva	13	m <sup>2</sup>	14
	<b>0726048</b>	Izolacija u ploči EV IT-FLEX samoljepljiva	19	m <sup>2</sup>	10
	<b>0726049</b>	Samoljepljiva izolacijska traka EV IT-FLEX 50 mm x 3 mm x 15 m		kom	12
	<b>0726054</b>	CIJEVNA IZOLACIJA IT-FLEX SOLAR 22x13		m <sup>1</sup>	30
	<b>0726055</b>	CIJEVNA IZOLACIJA K-FLEX SOLAR 28x13		m <sup>1</sup>	30
	<b>0726052</b>	LJEPILO ZA IZOLACIJU EV 0,8 Litara		kom	12
	<b>0726053</b>	LJEPILO ZA IZOLACIJU EV 0,425 Litara		kom	24





## PlamaFLEX SSL+ ALPet

**OPIS:** PlamaFLEX SSL+ ALpet cjevna izolacija izrađena je od ekspandiranog polietilena i proizvodi se u skladu sa internacionalnim standardom CE EN 14313. Ova visokokvalitetna cjevna izolacija ima dodatni unutrašnji sloj HD folije i vanjski zaštitni sloj ALPet folije koja osigurava odličnu zaštitu od mehaničkih utjecaja, te pruža odličnu termičku i zvučnu izolaciju cjevi. Izrađuje se u sivoj boji sa debljinom stjenke 4mm. Vanjski sloj ALPet folije daje napredne izolacijske karakteristike posebno u sprečavanju nastanka kondenzacije obzirom da je koeficijent difuzije vodene pare  $\mu = 17\ 000$ .

### KARAKTERISTIKE PROIZVODA

- Debljina EPE (ISO 1923) -  $4 \pm 10\%$  mm
- Gustoća EPE (ISO 845) -  $25 \pm 10\%$  kg/m<sup>3</sup>
- Termička stabilnost (ISO 2796) (24h)  $-30^{\circ}\text{C}$ : -0,1% ;  $+90^{\circ}\text{C}$ : -3,7%
- Paropropustnost (ISO 1663)  $>17000\mu$
- Toplotna provodljivost (DIN 52613) -  $< 0,036$  W/mK
- Boja - srebrna

**PRIMJENA:** Plama FLEX ispunjava najvažnije kriterije za izolaciju centralnih grijanih cjevovoda, klima izolacije, sanitarne izolacije i odvodnih cjevovoda. Osnovna karakteristika cjevne izolacije je elastičnost i visoka otpornost na oštećenja. Zatvoreno ćelijska cjevna izolacija pogodna je za montažu ispod žbuke i plivajućeg poda. Plama FLEX SSL AL pet izolacija, s obzirom da je prekrivena slojem ALPET srebrne folije, povećava otpornost na difuziju vodene pare i daje fini dekorativni izgled dok dodatni unutrašnji sloj sloj HD folije omogućava bržu i efikasniju ugradnju

### Asortiman Plama FLEX SSL + ALPet cjevne izolacije:

Šifra Vokel	VANJSKI PROMJER INSTALACIJE		Debljina stjenke «B» mm	Pakiranje (m/paket)
	Bakrene cijevi «A» mm	Čelične cijevi "		
<b>0703087</b>	15	1/4	4	210
<b>0703088</b>	18	3/8	4	210
<b>0703089</b>	22	1/2	4	210
<b>0703090</b>	28	3/4	4	210
<b>0703091</b>	35	1	4	120
<b>0703092</b>	42	1+1/4	4	120

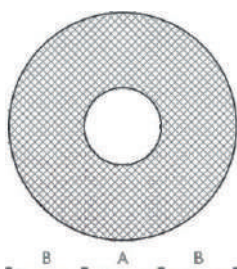



	<p><b>71169</b></p> <p><b>0635209</b></p> <p><b>0635210</b></p> <p><b>71252</b></p>	<p>BOJLER ELEKTRIČNI PROTOČNI VED 12/6 12 kW ART.308015</p> <p>BOJLER ELEKTRIČNI PROTOČNI VED E 18/7 18 kW ART.0010014913</p> <p>BOJLER ELEKTRIČNI PROTOČNI VED E 21/7 21 kW ART.0010014914</p> <p>BOJLER ELEKTRIČNI PROTOČNI VED 24/6 24 kW ART.308018</p>
	<p><b>0635192</b></p> <p><b>0635193</b></p>	<p>BOJLER ELEKTRIČNI PROTOČNI VED E 18/7 INT ART.10007720</p> <p>BOJLER ELEKTRIČNI PROTOČNI VED E 21/7 INT ART.10007721</p>
	<p><b>0681023</b></p> <p><b>0681024</b></p> <p><b>0681025</b></p> <p><b>0681026</b></p> <p><b>0681027</b></p> <p><b>0681028</b></p> <p><b>0681029</b></p> <p><b>0681030</b></p> <p><b>0681031</b></p> <p><b>0681032</b></p>	<p>TERMO BLOK VE 6 kW VE6/14 SEE ART.0010023706</p> <p>TERMO BLOK VE 9 kW VE9/14 SEE ART.0010023707</p> <p>TERMO BLOK VE 12 kW VE12/14 SEE ART.0010023708</p> <p>TERMO BLOK VE 14 kW VE14/14 SEE ART.0010023709</p> <p>TERMO BLOK VE 18 kW VE18/14 SEE ART.0010023710</p> <p>TERMO BLOK VE 21 kW VE21/14 SEE ART.0010023711</p> <p>TERMO BLOK VE 24 kW VE24/14 SEE ART.0010023712</p> <p>TERMO BLOK VE 28 kW VE28/14 SEE ART.0010023713</p> <p>SPOJNI SET (TROSMJERNI VENTIL+NTC OSJETNIK) ART.0010027587</p> <p>VANJSKI TEMPERATURNI OSJETNIK ART.0020266791</p>
	<p><b>0635228</b></p> <p><b>0635229</b></p> <p><b>0635230</b></p> <p><b>0635231</b></p>	<p>ELEKTRIČNA SOBNA GRIJALICA VER 100/5 1 kW ART.10023956</p> <p>ELEKTRIČNA SOBNA GRIJALICA VER 150/5 1,5 kW ART.10023957</p> <p>ELEKTRIČNA SOBNA GRIJALICA VER 200/5 2 kW ART.10023958</p> <p>ELEKTRIČNA SOBNA GRIJALICA VER 250/5 2,5 kW ART.10023959</p>

# Zašto Vaillant?

Mi upotpunjujemo naše sustave.

Panelni radijatori



Jer  Vaillant misli dalje.

<b>Kompaktni radijatori</b> <b>Tip 22</b> 2 panela, 2konvektora					
		visina / mm			
		Vokel Šifra			
		300	500	600	900
dužina / mm	400			<b>1471005</b>	<b>1471001</b>
	500				
	600		<b>1471016</b>	<b>1471006</b>	<b>1472002</b>
	700				
	800	<b>1471024</b>	<b>1471017</b>	<b>1471007</b>	<b>1471003</b>
	900				
	1000	<b>1471025</b>	<b>1471018</b>	<b>1471008</b>	<b>1471004</b>
	1100				
	1200	<b>1471026</b>	<b>1471019</b>	<b>1471009</b>	
	1300				
	1400	<b>1471027</b>	<b>1471020</b>	<b>1471010</b>	
	1500				
	1600	<b>1471028</b>	<b>1471021</b>	<b>1471011</b>	
	1800	<b>1471029</b>	<b>1471022</b>	<b>1471012</b>	
	2000	<b>1471030</b>	<b>1471023</b>	<b>1471013</b>	
	2200			<b>1471014</b>	
	2400			<b>1471015</b>	
2600					
2800					
3000					

Šifra Vokel

<b>Ventilski radijatori</b> <b>Tip 22</b> 2 panela, 2konvektora					
		visina / mm			
		Vokel Šifra			
		300	500	600	900
dužina / mm	400			<b>1472006</b>	<b>1472001</b>
	500				
	600		<b>1472017</b>	<b>1472007</b>	<b>1472002</b>
	700				
	800	<b>1472025</b>	<b>1472018</b>	<b>1472008</b>	<b>1472003</b>
	900				
	1000	<b>1472026</b>	<b>1472019</b>	<b>1472009</b>	<b>1472004</b>
	1100				
	1200	<b>1472027</b>	<b>1472020</b>	<b>1472010</b>	<b>1472005</b>
	1300				
	1400	<b>1472028</b>	<b>1472021</b>	<b>1472011</b>	
	1500				
	1600	<b>1472029</b>	<b>1472022</b>	<b>1472012</b>	
	1800	<b>1472030</b>	<b>1472023</b>	<b>1472013</b>	
	2000	<b>1472031</b>	<b>1472024</b>	<b>1472014</b>	
	2200			<b>1472015</b>	
	2400			<b>1472016</b>	
2600					
2800					
3000					

Šifra Vokel



**Kompaktni radiator Tip 22: 2 panela, 2konvektora**

ŠIFRA VOKEL	OPIS	DIMENZIJA	ART.
1471001	Radijator Vaillant kompakt	K22 H900 L400	0919041211
1471002	Radijator Vaillant kompakt	K22 H900 L600	0919061211
1471003	Radijator Vaillant kompakt	K22 H900 L800	0919081211
1470004	Radijator Vaillant kompakt	K22 H900 L1000	0919101211
1471005	Radijator Vaillant kompakt	K22 H600 L400	1916041211
1471006	Radijator Vaillant kompakt	K22 H600 L600	0916061211
1471007	Radijator Vaillant kompakt	K22 H600 L800	0916081211
1471008	Radijator Vaillant kompakt	K22 H600 L1000	0916101211
1471009	Radijator Vaillant kompakt	K22 H600 L1200	0916121211
1471010	Radijator Vaillant kompakt	K22 H600 L1400	0916141211
1471011	Radijator Vaillant kompakt	K22 H600 L1600	0916161211
1471012	Radijator Vaillant kompakt	K22 H600 L1800	0916181211
1471013	Radijator Vaillant kompakt	K22 H600 L2000	0916201211
1471014	Radijator Vaillant kompakt	K22 H600 L2200	0916221211
1471015	Radijator Vaillant kompakt	K22 H600 L2400	0916241211
1471016	Radijator Vaillant kompakt	K22 H500 L600	0915061211
1471017	Radijator Vaillant kompakt	K22 H500 L800	0915081211
1471018	Radijator Vaillant kompakt	K22 H500 L1000	0915101211
1471019	Radijator Vaillant kompakt	K22 H500 L1200	0915121211
1471020	Radijator Vaillant kompakt	K22 H500 L1400	0915141211
1471021	Radijator Vaillant kompakt	K22 H500 L1600	0915161211
1471022	Radijator Vaillant kompakt	K22 H500 L1800	0915181211
1471023	Radijator Vaillant kompakt	K22 H500 L2000	0915201211
1471024	Radijator Vaillant kompakt	K22 H300 L800	0913081211
1471025	Radijator Vaillant kompakt	K22 H300 L1000	0913101211
1471026	Radijator Vaillant kompakt	K22 H300 L1200	0913121211
1471027	Radijator Vaillant kompakt	K22 H300 L1400	0913141211
1471028	Radijator Vaillant kompakt	K22 H300 L1600	0913161211
1471029	Radijator Vaillant kompakt	K22 H300 L1800	0913181211
1471030	Radijator Vaillant kompakt	K22 H300 L2000	0913201211

**Ventilski radiator Tip 22: 2 panela, 2konvektora**

ŠIFRA VOKEL	OPIS	DIMENZIJA	ART.
1472001	Radijator Vaillant ventilski	V22 H900 L400	0919042241
1472002	Radijator Vaillant ventilski	V22 H900 L600	0919062241
1472003	Radijator Vaillant ventilski	V22 H900 L800	0919082241
1472004	Radijator Vaillant ventilski	V22 H900 L1000	091902241
1472005	Radijator Vaillant ventilski	V22 H900 L1200	0919122241
1472006	Radijator Vaillant ventilski	V22 H600 L400	0916042241
1472007	Radijator Vaillant ventilski	V22 H600 L600	0916062241
1472008	Radijator Vaillant ventilski	V22 H600 L800	0916082241
1472009	Radijator Vaillant ventilski	V22 H600 L1000	0916102241
1472010	Radijator Vaillant ventilski	V22 H600 L1200	0916122241
1472011	Radijator Vaillant ventilski	V22 H600 L1400	0916142241
1472012	Radijator Vaillant ventilski	V22 H600 L1600	0916162241
1472013	Radijator Vaillant ventilski	V22 H600 L1800	0916182241
1472014	Radijator Vaillant ventilski	V22 H600 L2000	0916202241
1472015	Radijator Vaillant ventilski	V22 H600 L2200	0916222241
1472016	Radijator Vaillant ventilski	V22 H600 L2400	0916242241
1472017	Radijator Vaillant ventilski	V22 H500 L600	0915062241
1472018	Radijator Vaillant ventilski	V22 H500 L800	0915082241
1472019	Radijator Vaillant ventilski	V22 H500 L1000	0915102241
1472020	Radijator Vaillant ventilski	V22 H500 L1200	0915122241
1472021	Radijator Vaillant ventilski	V22 H500 L1400	0915142241
1472022	Radijator Vaillant ventilski	V22 H500 L1600	0915162241
1472023	Radijator Vaillant ventilski	V22 H500 L1800	0915182241
1472024	Radijator Vaillant ventilski	V22 H500 L2000	0915202241
1472025	Radijator Vaillant ventilski	V22 H300 L800	0913082241
1472026	Radijator Vaillant ventilski	V22 H300 L1000	0913102241
1472027	Radijator Vaillant ventilski	V22 H300 L1200	0913122241
1472028	Radijator Vaillant ventilski	V22 H300 L1400	0913142241
1472029	Radijator Vaillant ventilski	V22 H300 L1600	0913162241
1472030	Radijator Vaillant ventilski	V22 H300 L1800	0913182241
1472031	Radijator Vaillant ventilski	V22 H300 L2000	0913202241

## Kompaktni i ventilski radijatori

Toplinski učinak (W)

Tip	Temp.	Visina mm	Dužina (mm)																			
			400	500	600	700	800	900	1000	1100	1200	1300	1400	1500	1600	1800	2000	2200	2400	2600	2800	3000
11	90/70/20	500	424	531	637	743	849	955	1,061	1,167	1,273	1,379	1,485	1,592	1,698	1,910	2,122	2,334	2,546	2,759	2,971	3,183
	75/65/20	500	332	415	497	580	663	746	829	912	995	1,078	1,161	1,244	1,326	1,492	1,658	1,824	1,990	2,155	2,321	2,487
	90/70/20	600	487	609	731	853	974	1,096	1,218	1,340	1,462	1,583	1,705	1,827	1,949	2,192	2,436	2,680	2,923	3,167	3,410	3,654
	75/65/20	600	381	476	571	666	762	857	952	1,047	1,142	1,238	1,333	1,428	1,523	1,714	1,904	2,094	2,285	2,475	2,666	2,856
	20/70/20	900	658	823	987	1,152	1,316	1,481	1,645	1,810	1,974											
	75/65/20	900	515	644	772	901	1,030	1,158	1,287	1,416	1,544											
21	90/70/20	500	606	758	910	1,061	1,213	1,364	1,516	1,668	1,819	1,971	2,122	2,274	2,426	2,729	3,032					
	75/65/20	500	474	593	711	830	948	1,067	1,185	1,304	1,422	1,541	1,659	1,778	1,896	2,133	2,370					
	90/70/20	600	696	870	1,044	1,218	1,392	1,566	1,740	1,914	2,088	2,262	2,436	2,610	2,784	3,132	3,480					
	75/65/20	600	544	681	817	953	1,089	1,225	1,361	1,497	1,633	1,769	1,905	2,042	2,178	2,450	2,722					
	90/70/20	900	940	1,175	1,410	1,645	1,880	2,115	2,350	2,585	2,820	3,055	3,290	3,525	3,760	4,230	4,700					
	75/65/20	900	736	920	1,104	1,288	1,472	1,656	1,840	2,024	2,208	2,392	2,576	2,760	2,944	3,312	3,680					
22	90/70/20	300	535	699	803	937	1,070	1,204	1,338		1,606		1,873		2,141	2,408	2,676	2,944	3,211	3,479	3,746	4,014
	75/65/20	300	421	526	631	736	842	947	1,052		1,262		1,473		1,683	1,894	2,104	2,314	2,525	2,735	2,946	3,156
	90/70/20	400	670	838	1,005	1,173	1,340	1,508	1,675		2,010		2,345		2,680	3,015	3,350	3,685	4,020	4,355	4,690	5,025
	75/65/20	400	526	658	789	921	1,052	1,184	1,315		1,578		1,841		2,104	2,367	2,630	2,893	3,156	3,419	3,682	3,945
	90/70/20	500	798	998	1,197	1,397	1,596	1,796	1,995	2,195	2,394	2,594	2,793	2,993	3,192	3,591	3,990	4,389	4,788	5,187	5,586	5,985
	75/65/20	500	625	782	938	1,094	1,250	1,407	1,563	1,719	1,876	2,032	2,188	2,345	2,501	2,813	3,126	3,439	3,751	4,064	4,376	4,689
	90/70/20	600	920	1,150	1,380	1,610	1,840	2,070	2,300	2,530	2,760	2,990	3,220	3,450	3,680	4,140	4,600	5,060	5,520	5,980	6,440	6,900
	75/65/20	600	719	899	1,079	1,259	1,438	1,618	1,798	1,978	2,158	2,337	2,517	2,697	2,877	3,236	3,596	3,956	4,315	4,675	5,034	5,394
	90/70/20	900	1,255	1,569	1,882	2,196	2,510	2,823	3,137	3,451	3,764	4,077	4,392	4,706	5,019	5,647	6,274	6,901	7,529	8,156	8,784	9,411
	75/65/20	900	979	1,224	1,469	1,714	1,958	2,203	2,448	2,693	2,938	3,182	3,427	3,672	3,917	4,406	4,896	5,386	5,875	6,365	6,854	7,344
33	90/70/20	300	766		1,150		1,533		1,916		2,299		2,682		3,066	3,449	3,832	4,215	4,598	4,982	5,365	5,748
	75/65/20	300	602		904		1,205		1,506		1,807		2,108		2,410	2,711	3,012	3,313	3,614	3,916	4,217	4,518
	90/70/20	600	1,300	1,626	1,951		2,601	2,926	3,251	3,576	3,901	4,226	4,551	4,877	5,202	5,852	6,502	7,152	7,802	8,453	9,103	9,753
	75/65/20	600	1,018	1,273	1,528		2,037	2,291	2,546	2,801	3,055	3,310	3,564	3,819	4,074	4,583	5,092	5,601	6,110	6,620	7,129	7,638
	90/70/20	900	1,753	2,191	2,629	3,067	3,506	3,944	4,382	4,820	5,258	5,697	6,135	6,573	7,011	7,888	8,764					
	75/65/20	900	1,368	1,710	2,025	2,394	2,736	3,078	3,420	3,762	4,104	4,446	4,788	5,130	5,472	6,156	6,840					

**Legenda:**

- K označava kompaktne radijatore.
- V označava ventilski radijatore s ventilom.

**Skladišni program:**

- V i K
  - K
- Ostale dimenzije prema narudžbi.





## Mjere za montažu kompaktnog radijatora

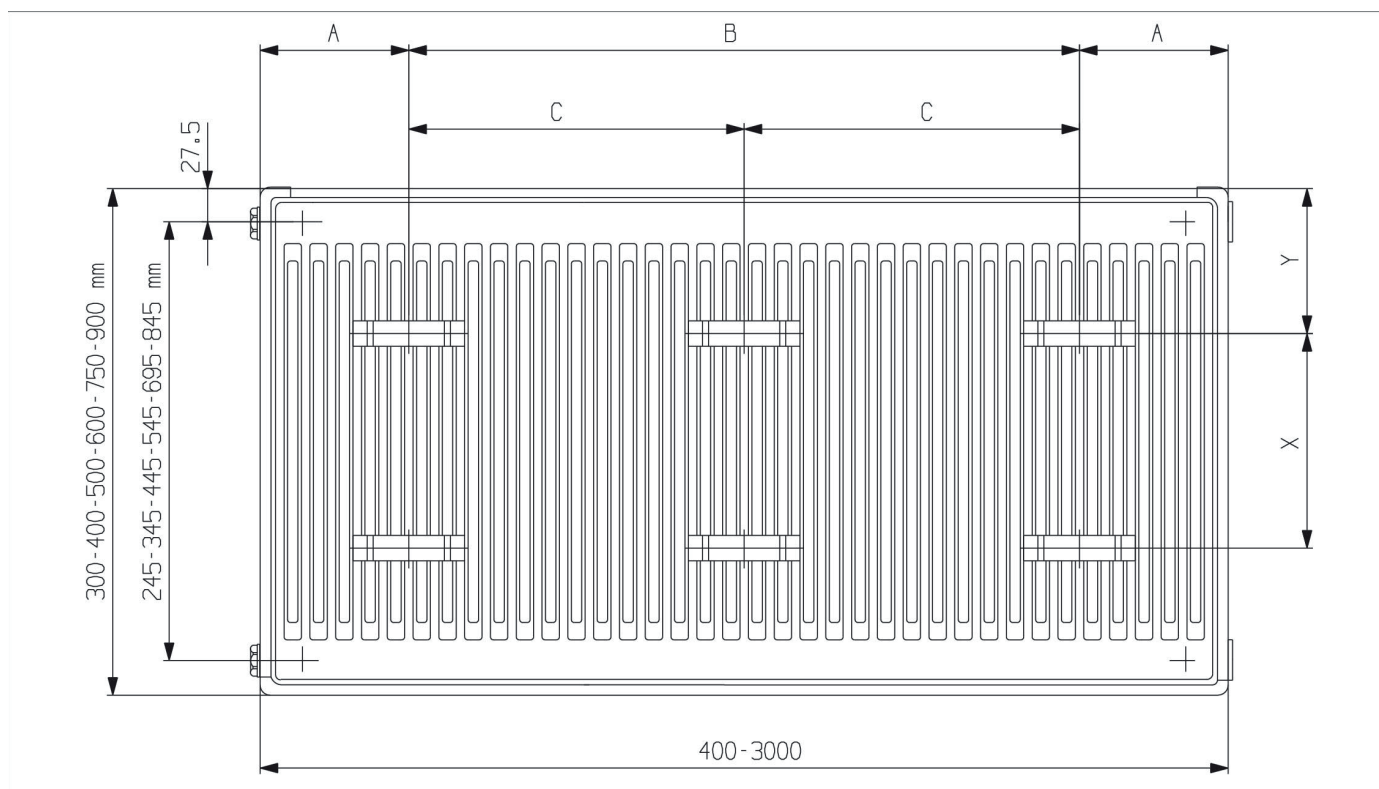

### Tehnički podaci

Tip	X	Y	Dužina	Br. držača	L (mm)	11			21 - 22 - 23		
						A mm	B mm	B mm	A mm	B mm	C mm
300	155	72.5	400mm - 1500mm	4	400	125	150	-	137,5	125	-
400	155	122.5			500	125	250	-	137,5	225	-
500	255	122.5	1600mm - 3000mm	6	600	125	350	-	137,5	325	-
600	355	122.5			700	125	450	-	137,5	425	-
900	655	122.5			800	125	550	-	137,5	525	-
					900	125	650	-	137,5	625	-
					1000	125	750	-	137,5	725	-
					1100	125	850	-	137,5	825	-
					1200	125	950	-	137,5	925	-
					1300	125	1050	-	137,5	1025	-
					1400	125	1150	-	137,5	1125	-
					1500	125	1250	-	137,5	1225	-
			1600	125	-	675	137,5	-	662,5		
			1800	125	-	775	137,5	-	762,5		
			2000	125	-	875	137,5	-	862,5		
			2200	125	-	975	137,5	-	962,5		
			2400	125	-	1075	137,5	-	1062,5		
			2600	125	-	1175	137,5	-	1162,5		
			2800	125	-	1275	137,5	-	1262,5		
			3000	125	-	1375	137,5	-	1362,5		

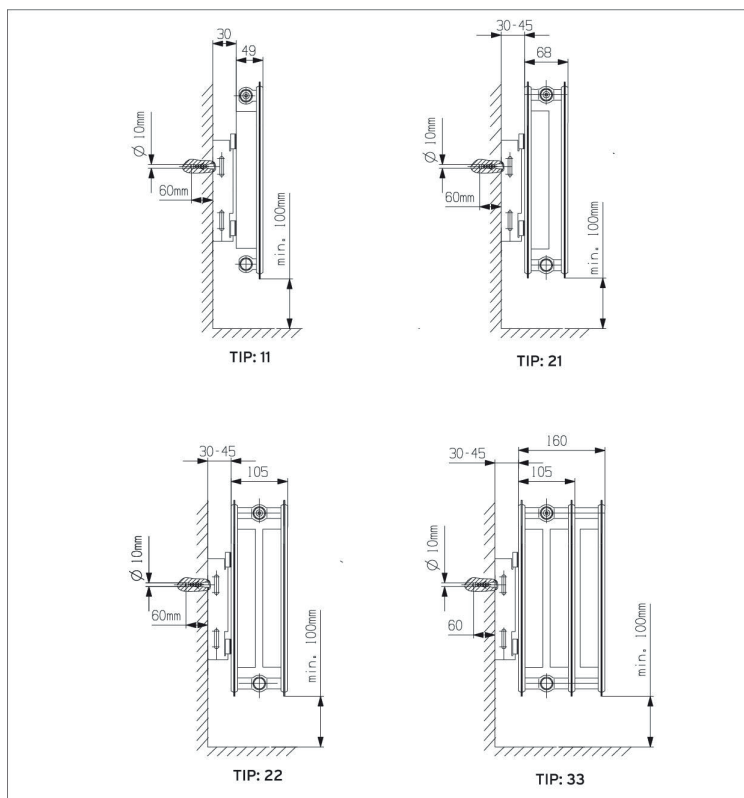

Mjere za montažu ventilskog radijatora

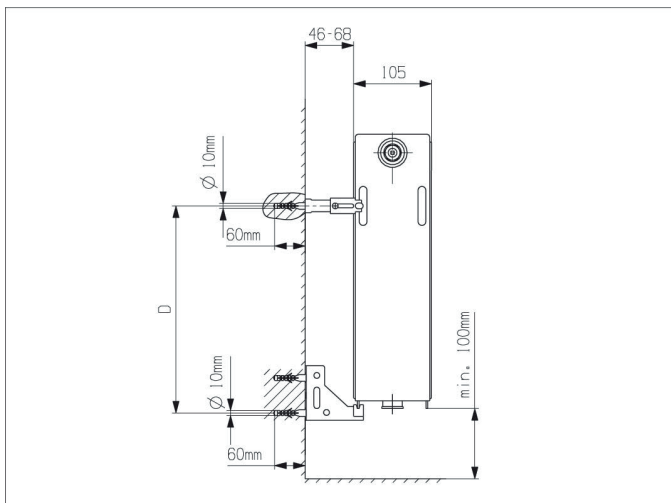

Tip radijatora 21, 22

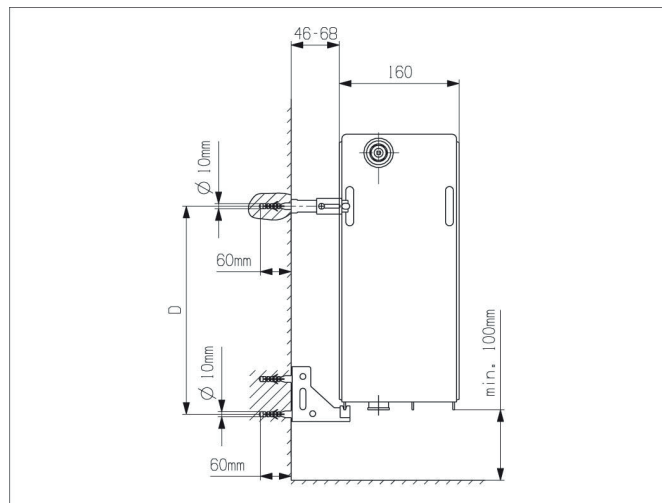

Tip radijatora 33

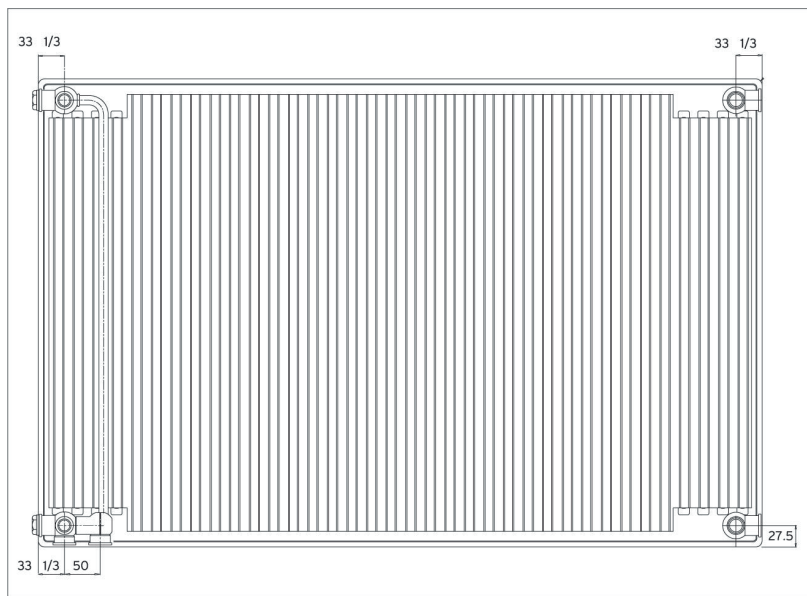
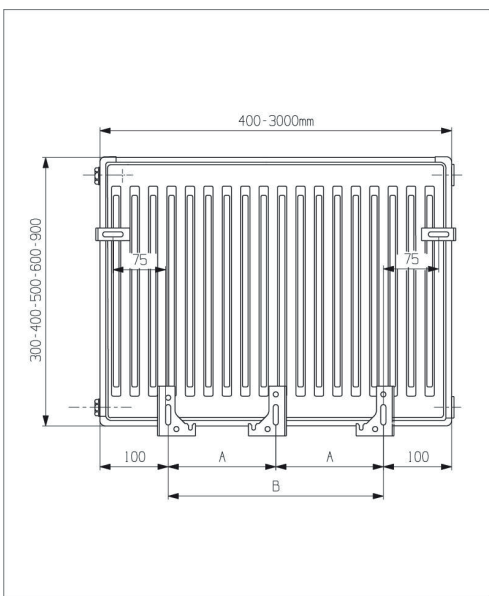

Tehnički podaci

Visina radijatora (mm)	Kota "D" (mm)
300	200
400	300
500	400
600	500
900	800

Dužina radijatora (mm)	Kota "A" (mm)   Kota "B" (mm)	
	Kota "A" (mm)	Kota "B" (mm)
400	-	200
500	-	300
600	-	400
700	-	500
800	-	600
900	-	700

Dužina radijatora (mm)	Kota "A" (mm)   Kota "B" (mm)	
	Kota "A" (mm)	Kota "B" (mm)
1000	-	800
1100	-	900
1200	-	1000
1300	-	1100
1400	-	1200
1500	-	1300
1600	700	1400
1800	800	1600
2000	900	1800
2200	1000	2000
2400	1100	2200
2600	1200	2400
2800	1300	2600
3000	1400	2800

## Materijal i montaža

Osnovni podaci za Vaillant radijatore sažeti su u nastavnoj tablici:

	Vaillant radijatori
Probni tlak	13 bar
Maks. radni tlak	10 bar
Maks. radna temperatura	120 °C
Priključci	1/2"
Certificirano	ISO 9000
Antikorozivna zaštita	- hladno valjani čelični lim - Zn fosfatiranje - katodno temeljno bojanje - elektrostatski nanos praškastog materijala, RAL 9010
Toplinski učinak utvrđen prema	EN 442
Profiliran panel - korak	25 mm
Debljina lima	1,15 mm



## Tehnički podaci

Tip	Visina	Razmak između priključaka	Dubina	Dužina min/maks.	Težina (kg/m)	Sadržaj vode (l/m)	« n »
K/V - 11	500	445	49	400-3000	15,1	2,5	1,3619000
	600	545	49	400-3000	17,8	2,9	1,3744000
	900	845	49	400-2000	26,3	4,2	1,3757000
K/V - 21	500	445	68	400-2000	24,7	4,9	1,3458000
	600	545	68	400-3000	29,3	5,8	1,3533000
	900	845	68	400-2000	43	8,3	1,3746000
K/V - 22	300	245	105	400-3000	19,3	3	1,3325000
	400	345	105	400-3000	24,8	3,9	1,3349000
	500	445	105	400-3000	30,2	4,8	1,3373000
	600	545	105	400-3000	35,5	5,7	1,3397000
	900	845	105	400-3000	52,3	8,7	1,3759000
K/V - 33	300	245	160	400-3000	28,8	4,5	1,3383000
	600	545	160	400-3000	53,2	8,7	1,3613000
	900	845	160	400-2000	79,5	10,2	1,3904000

## Legenda:

- K označava kompaktne radijatore bez ventila i sa fiksiranim, stražnjim držačima.
- V označava ventilne radijatore s ventilom bez stražnjih držača ali s dojnim držačima (u obimu isporuke).

## Tipovi panelnih radijatora

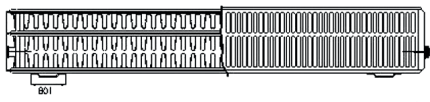
Tip 11		= 1 panel + 1 konvektor
Tip 21		= 2 panela + 1 konvektor
Tip 22		= 2 panela + 2 konvektora
Tip 33		= 3 panela + 3 konvektora

Jamstvo za Vaillant radijatore : 10 godina

### Vaillant radijatori ukratko:

- kompaktni i ventilski radijatori
- hladno valjani čelični lim debljine 1,2 mm s antikorozivnom zaštitom
- dužine 400 do 3000 mm i visine 300 do 900 mm
- tipovi od 11 (1 panel + 1 konvektor) do 33 (3 panela + 3 konvektora)
- nosači radijatora su sastavni dio isporuke



### Certifikati i priznanja

Dokaz vrhunske kvalitete i pouzdanosti su i dodijeljeni certifikati i priznanja.



## Elektro kotao EI-Cm CLASSIC

### OSNOVNE DIMENZIJE:

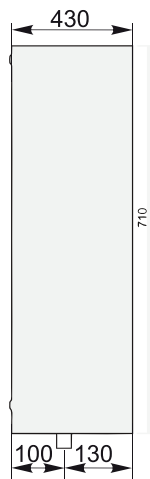
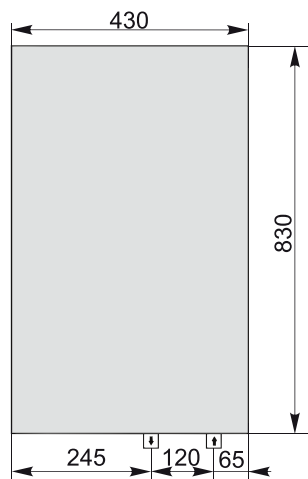

Regulacija - EI-Cm Classic

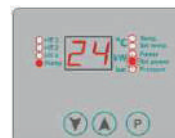

Moderna digitalna modularajuća regulacija optimalno vodi rad elektrogrijača tako da optimizira potrošnju električne energije sa učinkom elektrokotla.

EI-Cm Classic		6	9	12	18	24	27
Toplinski učin	(kW)	6	9	12	18	24	27
Sadržaj vode u kotlu	(lit.)	12,5	12,5	12,5	12,5	12,5	12,5
Masa kotla (bez vode)	(kg)	23	24	24	25	25	25
Max. radna temperatura	(°C)	80					
Max. radni pretlak	(bar)	2,5					
Polazni/povratni vod		DN20 (3/4")					
Električni grijači	(kW)	3x2	3+6	2x6	3x6	4x6	4x6,75
Presjek vodiča	(mm <sup>2</sup> )	5x2,5	5x2,5	5x4	5x6	5x6	5x6
Ekspanzijska posuda	(lit.)	10					
Priključni napon	(V/Hz)	400/50					
Širina kotla	(mm)	430					
Visina kotla	(mm)	710					
Dubina kotla	(mm)	230					
Razred energetske učinkovitosti		D					



**1453001** ELEKTRO KOTAO EL- CM CLASSIC 6 kW

**1453003** ELEKTRO KOTAO EL- CM CLASSIC 12 kW

**1453004** ELEKTRO KOTAO EL - CM CLASSIC 18 kW



## Elektro kotao EI-Cm ePlus

### OSNOVNE DIMENZIJE:

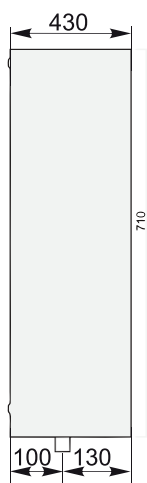
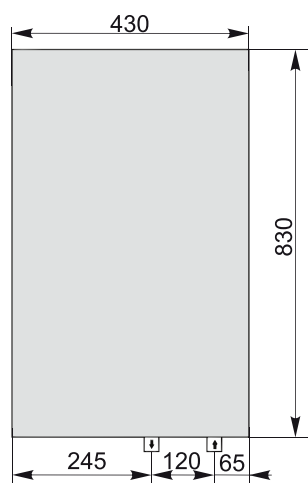

Regulacija - EI-Cm Classic



Moderna digitalna modulirajuća regulacija optimalno vodi rad elektrogrijača tako da optimizira potrošnju električne energije sa učinkom elektrokotla.

EI-Cm ePlus		6	9	12	18	24
Toplinski učin	(kW)	6	9	12	18	24
Sadržaj vode u kotlu	(lit.)	12,5	12,5	12,5	12,5	12,5
Masa kotla (bez vode)	(kg)	25	25	25	25	25
Max. radna temperatura	(°C)	80				
Max. radni pretlak	(bar)	2,6				
Polazni/povratni vod	(R)	G3/4"				
Električni grijači	(kW)	3x2	6x1,5	6x2	9x2	9x2,7
Presjek vodiča	(mm <sup>2</sup> )	5x2,5	5x2,5	5x4	5x4	5x6
Ekspanzijska posuda	(lit.)	7				
Priključni napon	(V/Hz)	400/50				
Širina kotla	(mm)	430				
Visina kotla	(mm)	710				
Dubina kotla	(mm)	230				
Razred energetske učinkovitosti		D				



<b>1453007</b>	ELEKTRO KOTAO EL- CM EPLUS 6kW
<b>1453008</b>	ELEKTRO KOTAO EL- CM EPLUS 9kW
<b>1453009</b>	ELEKTRO KOTAO EL - CM EPLUS 12kW
<b>1453010</b>	ELEKTRO KOTAO EL - CM EPLUS 18kW
<b>1453011</b>	ELEKTRO KOTAO EL - CM EPLUS 24kW

## SOBNA PEĆ NA PELET ZA CENTRALNO GRIJANJE CENTRO PELET ZV16-32



- 1 - Regulacija
- 2 - Glavni prekidač
- 3 - Priključak za odvod dimnih plinova
- 4 - Priključak za dovod svježeg zraka
- 5 - Polazni vod
- 6 - Povratni vod
- 7 - Poluga za čišćenje dimovodnih prolaza

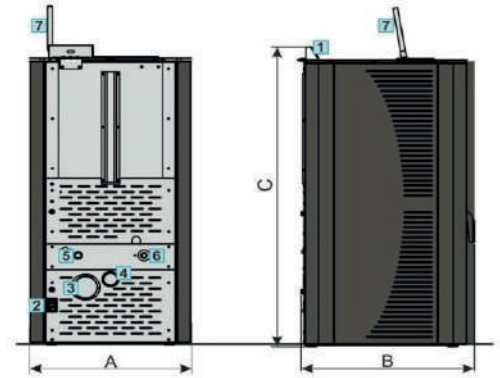

**Isporučka:**  
 • Sobna peć s regulacijom, u kartonskoj ambalaži



**Odvod dimnih plinova:**  
 • Jedna peć na jedan dimnjak



**Odvod dimnih plinova:**  
 • Vanjskim dimovodnim cijevima koje se moraju spojiti prema lokalnim propisima



**Dodatna oprema:**  
 • komplet dimovodnih cijevi za CentroPelet ZV za fasadni priključak (dimovodna cijev 1m, dimovodna cijev 0,5m, poklopac T-komada, T-komad, silikonska rozeta, koljeno 90°, dimovodna cijev 0,25m, koljeno 45°)

CentroPelet		ZV16	ZV20	ZV24	ZV32
Ukupni toplinski učin	kW	4,89 - 16,1	5,1 - 18,46	5,1 - 22,14	8,57 - 30,48
Toplinski učin na strani vode	kW	4,04 - 12,35	3,9 - 15,05	3,9 - 18,1	6,51 - 24,38
Toplinski učin na okolni prostor	kW	1,22 - 3,31	1,2 - 3,41	1,2 - 4,04	2,06 - 6,1
Potrošnja peleta	kg/h	1,04 - 3,46	1,08 - 4,00	1,08 - 4,80	1,82 - 6,6
Iskoristivost	%	95,9 - 94,5	94,3 - 95,4	95,4 - 93,8	95,4 - 93,8
Promjer dimovodne cijevi	Ømm	80	80	80	100
Volumen spremnika	kg	30	42	42	57
Priključak za dovod zraka	Ømm	50	50	50	60
Količina vode u peći	lit	31	50	50	60
Autonomija	h	8,5 - 29	10,5 - 39	9 - 39	8,5 - 31
Potrošnja struje pri nom. učinku	W	110 - 320	140-350	140 - 350	140-350
Razina buke (min-max)	dB	31-48	31-48	31-48	31-48
Dimenzije (A/B/C)	mm	520/630/1115	615/675/1270	615/675/1270	672/722/1384
Masa	kg	160	230	230	280

Š.Vokel	Opis
0637378	SOBNA PEĆ NA PELET ZA CENTRALNO GRIJANJE ZV-16-BIJELA
0637379	SOBNA PEĆ NA PELET ZA CENTRALNO GRIJANJE ZV-16-SIVA
0637380	SOBNA PEĆ NA PELET ZA CENTRALNO GRIJANJE ZV-16-CRVENA
0637349	SOBNA PEĆ NA PELET ZA CENTRALNO GRIJANJE ZV-20-BIJELA
0637350	SOBNA PEĆ NA PELET ZA CENTRALNO GRIJANJE ZV-20-SIVA
0637351	SOBNA PEĆ NA PELET ZA CENTRALNO GRIJANJE ZV-20-CRVENA
0637352	SOBNA PEĆ NA PELET ZA CENTRALNO GRIJANJE ZV-24-BIJELA
0637353	SOBNA PEĆ NA PELET ZA CENTRALNO GRIJANJE ZV-24-SIVA
0637354	SOBNA PEĆ NA PELET ZA CENTRALNO GRIJANJE ZV-24-CRVENA
0637355	SOBNA PEĆ NA PELET ZA CENTRALNO GRIJANJE ZV-32-BIJELA
0637356	SOBNA PEĆ NA PELET ZA CENTRALNO GRIJANJE ZV-32-SIVA
0637357	SOBNA PEĆ NA PELET ZA CENTRALNO GRIJANJE ZV-32-CRVENA

	<p><b>1433001</b></p> <p><b>1433002</b></p>	<p>DIMNA CIJEV Ø 80 x 0,5 m THERMIA</p> <p>DIMNA CIJEV Ø 80 x 1 m THERMIA</p>
	<p><b>1433003</b></p>	<p>DIMNO KOLJENO Ø 80 THERMIA</p>
	<p><b>1433004</b></p>	<p>DIMNA ROZETA Ø 80 THERMIA</p>
 <p><b>1433006</b></p> <p><b>1433005</b></p>	<p><b>1433005</b></p> <p><b>1433006</b></p>	<p>DIMNA KONDENZACIJSKA KAPA Ø 80 THERMIA</p> <p>DIMNA T-RAČVA Ø 80 THERMIA</p>

## PAVIFLOOR

STIROPOR S FOLIJOM

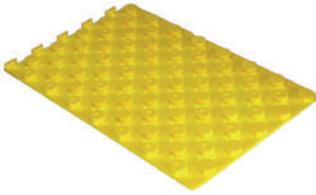

VOKEL ŠIFRA	DIMENZIJE DxŠxD (mm)	TOP. OTPORNOST m2 (K/W)	PAKIRANJE (m2)	ARTIKAL
<b>1440002</b>	1350x750x45	0,65	12,15	00116106
<b>1440006</b>	1350x750x50	0,80	10,125	00115140
<b>1440003</b>	1350x750x55	0,95	9,11	00114250

## STIROFLOOR NEW

STIROPOR S FOLIJOM



VOKEL ŠIFRA	DIMENZIJE DxŠxD (mm)	TOP. OTPORNOST m2 (K/W)	PAKIRANJE (m2)	ARTIKAL
<b>1440005</b>	1200x700x43	0,75	11,76	00115001

## TECKFLOOR

STIROPOR S PVC CRNOM FOLIJOM

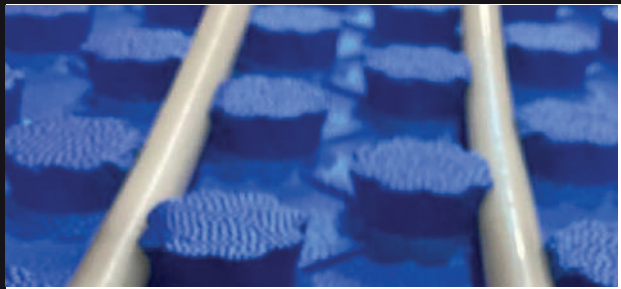
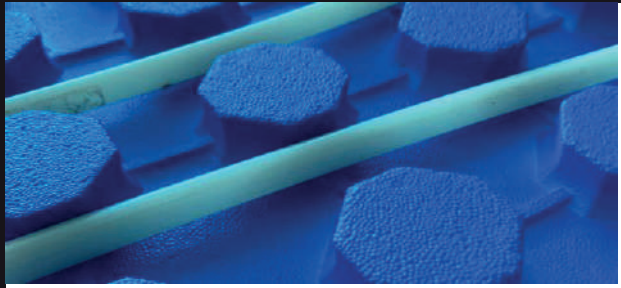

VOKEL ŠIFRA	DIMENZIJE DxŠxD (mm)	TOP. OTPORNOST m2 (K/W)	PAKIRANJE (m2)	ARTIKAL
<b>1440001</b>	1400x800x33	0,35	15,68	00114454
<b>1440007</b>	1400x800x43	0,65	11,20	00114613
<b>1440004</b>	1400x800x53	0,95	8,96	00114614

Šifra Vokel	Opis
 <p data-bbox="223 504 478 537">Raster polaganja cijevi 5 cm</p>	<p data-bbox="678 224 1476 280"><b>1458001</b> STIROPOR S PVC FOLIJOM ALPHA H32 (10+22) CL 150 PLOČA 1400x800 mm , Pakovanje: 17,92 m<sup>2</sup> (16 Ploča).</p> <p data-bbox="678 324 1476 380"><b>1458002</b> STIROPOR S PVC FOLIJOM ALPHA H42 (20+22) CL 150 PLOČA 1400x800 mm , Pakovanje: 13,44 m<sup>2</sup> (12 Ploča).</p> <p data-bbox="678 425 1476 481"><b>1458003</b> STIROPOR S PVC FOLIJOM ALPHA H52 (30+22) CL 150 PLOČA 1400x800 mm , Pakovanje: 10,08 m<sup>2</sup> (9 Ploča).</p>
 <p data-bbox="223 835 478 869">Raster polaganja cijevi 5 cm</p>	<p data-bbox="678 582 1428 638"><b>1458004</b> STIROPOR S FOLIJOM STAR H40 (19+21) CL 150 PLOČA 1200x800 mm , Pakovanje: 15,36 m<sup>2</sup> (16 Ploča).</p> <p data-bbox="678 728 1428 784"><b>1458005</b> STIROPOR S FOLIJOM STAR H50 (29+21) CL 150 PLOČA 1200x800 mm , Pakovanje: 11,52 m<sup>2</sup> (12 Ploča).</p>
 <p data-bbox="215 1160 486 1189">Raster polaganja cijevi 7,5 cm</p>	<p data-bbox="678 985 1460 1041"><b>1458006</b> STIROPOR S FOLIJOM COMFORT H58 (33+25) CL 150 PLOČA 1200x600 mm , Pakovanje: 7,20 m<sup>2</sup> (10 Ploča).</p>



## SERIJA AR- multifunkcionalna za grijanje i toplu vodu

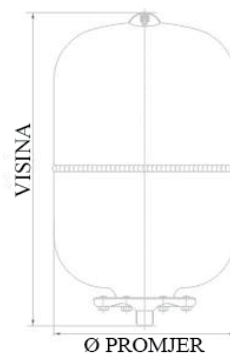

MODEL	VOKEL ŠIFRA	VISINA [mm]	PROMJER [mm]	TLAK [bar]	NAVOJ [inč]	ŠIFRA ARTIKLA
AR2	<b>1442001</b>	240	120	10	1/2"	AACMM00W01RE1

## SERIJA VA- za toplu vodu

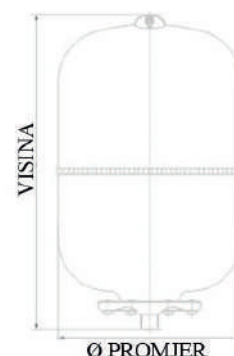

MODEL	VOKEL ŠIFRA	VISINA [mm]	PROMJER [mm]	TLAK [bar]	NAVOJ [inč]	ŠIFRA ARTIKLA
VA5	<b>1442002</b>	300	160	10	3/4"	AADVE00B01BD1
VA8	<b>1442003</b>	316	200	10	3/4"	AAEVE00B01BD1
VA12	<b>1442004</b>	295	280	10	3/4"	AAFVE00B01BD1
VA18	<b>1442005</b>	456	280	10	3/4"	AAGVE00B01BC1
VA24	<b>1442006</b>	483	280	10	1"	AAIVE00B01EC1
VA35	<b>1442007</b>	440	365	10	1"	AAJVE00B01EA1

## SERIJA VAV- za toplu vodu s nogarama

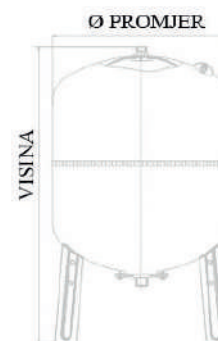

MODEL	VOKEL ŠIFRA	VISINA [mm]	PROMJER [mm]	TLAK [bar]	NAVOJ [inč]	ŠIFRA ARTIKLA
VAV50	<b>1442008</b>	697	365	10	1"	AAKVE01B01EA1
VAV100	<b>1442009</b>	849	495	10	1"	AANVE01B11EA1



## SERIJA VR- za grijanje

MODEL	VOKEL ŠIFRA	VISINA [mm]	PROMJER [mm]	TLAK [bar]	NAVOJ [inč]	ŠIFRA ARTIKLA
VR12	<b>1442010</b>	295	280	8	3/4"	AAFRE00R01BD1
VR18	<b>1442011</b>	456	280	8	3/4"	AAGRE00R01BC1
VR24	<b>1442012</b>	483	280	8	3/4"	AAIRE00R01DC1
VR35	<b>1442013</b>	440	365	8	3/4"	AAJRE00R01DA1
VR50	<b>1442014</b>	565	365	8	3/4"	AAKRE00R01DA1

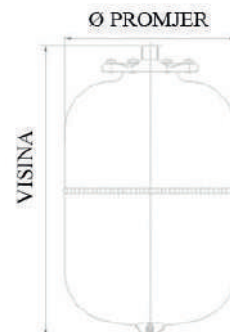

## SERIJA VRV- za grijanje s nogarama

MODEL	VOKEL ŠIFRA	VISINA [mm]	PROMJER [mm]	TLAK [bar]	NAVOJ [inč]	ŠIFRA ARTIKLA
VRV35	<b>1442015</b>	450	365	8	3/4"	AAJRE01R01DA1
VRV50	<b>1442016</b>	565	365	8	3/4"	AAKRE01R01DA1
VRV80	<b>1442017</b>	717	415	8	1"	AAMRE01R01EA1
VRV100	<b>1442018</b>	663	495	8	1"	AANRE01R01EA1
VRV150	<b>1442019</b>	795	550	8	1"	AAPRE01R01EA1



## SERIJA VRV- za grijanje s nogarama

MODEL	VOKEL ŠIFRA	VISINA [mm]	PROMJER [mm]	TLAK [bar]	NAVOJ [inč]	ŠIFRA ARTIKLA
VRV200	<b>1442020</b>	1085	600	8	1"	AAQRE01R21EA1
VRV250	<b>1442021</b>	1051	650	8	1"	AARRE01R21EA1
VRV300	<b>1442022</b>	1212	650	8	1"	AASRE01R21EA1

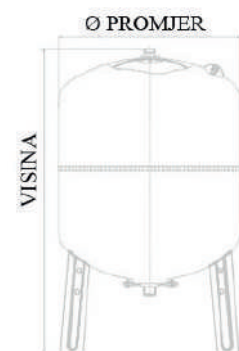

## SERIJA VRV- za grijanje s nogarama



MODEL	VOKEL ŠIFRA	VISINA [mm]	PROMJER [mm]	TLAK [bar]	NAVOJ [inč]	ŠIFRA ARTIKLA
VRV750	<b>1442029</b>	1950	750	10	2"	AAXRH31R31GP0
VRV1000	<b>1442030</b>	2160	800	10	2"	AAVRH31R31GP0
VRV1500	<b>1442031</b>	2360	960	10	2"	AAZRH31R31GP0

## SERIJA VSV- za solarni sustav s nogarama

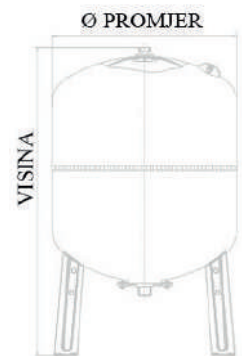

MODEL	VOKEL ŠIFRA	VISINA [mm]	PROMJER [mm]	TLAK [bar]	NAVOJ [inč]	ŠIFRA ARTIKLA
VSV50	<b>1442023</b>	565	365	10	3/4"	AAKPL01W01DA1
VS18	<b>1442027</b>	456	280	10	3/4"	AAGPL00W01BA1

NAPOMENA: VS18 ekspanzijska posuda bez nogara

## SERIJA VCP- za grijanja i bojlere

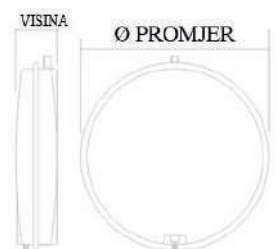

MODEL	VOKEL ŠIFRA	VISINA [mm]	PROMJER [mm]	TLAK [bar]	NAVOJ [inč]	ŠIFRA ARTIKLA
VPC387-8	<b>1442038</b>	85	387	3	3/8"	ZIEFD0BZA3245
VCP387-10	<b>1442024</b>	100	387	3	3/4"	ZIOFD0BZA33A5
VCP387-12	<b>1442025</b>	120	387	3	3/4"	ZIFFD0BZA33A5

## SERIJA VRP- za grijanje i bojlere

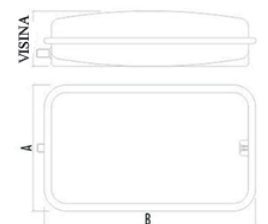



MODEL	VOKEL ŠIFRA	VISINA [mm]	DIMENZIJE [mm]	TLAK [bar]	NAVOJ [inč]	ŠIFRA ARTIKLA
VRP200-7	<b>1442026</b>	70	200x515	3	3/8"	ZI7GD0HZA32A5

	Š.Vokel	Opis	Jed.mj.
	0722001	PREDIZOLIRANA INOX CIJEV ZA SOLARNI SISTEM (AISI316L) 2IN2 DN16 L=10m ART.400	m
	0722002	PREDIZOLIRANA INOX CIJEV ZA SOLARNI SISTEM (AISI316L) 2IN2 DN16 L=15m ART.401	m
	0722003	PREDIZOLIRANA INOX CIJEV ZA SOLARNI SISTEM (AISI316L) 2IN2 DN16 L=20m ART.402	m
	0722004	PREDIZOLIRANA INOX CIJEV ZA SOLARNI SISTEM (AISI316L) 2IN2 DN16 L=25m ART.403	m
	0722005	PREDIZOLIRANA INOX CIJEV ZA SOLARNI SISTEM (AISI316L) 2IN2 DN20 L=10m ART.406	m
	0722006	PREDIZOLIRANA INOX CIJEV ZA SOLARNI SISTEM (AISI316L) 2IN2 DN20 L=15m ART.407	m
	0722007	PREDIZOLIRANA INOX CIJEV ZA SOLARNI SISTEM (AISI316L) 2IN2 DN20 L=20m ART.408	m
	0722008	PREDIZOLIRANA INOX CIJEV ZA SOLARNI SISTEM (AISI316L) 2IN2 DN20 L=25m ART.409	m
	0722041	SAVITLJIVA INOX CIJEV (AISI 316L) MF015 S00 DN 12 L=100m ART.419A	m
	0722018	SAVITLJIVA INOX CIJEV (AISI 316L) MF015 S00 DN 16 L=100m ART.420	m
	0722019	SAVITLJIVA INOX CIJEV (AISI 316L) MF015 S00 DN 20 L=100m ART.421	m
	0722029	SAVITLJIVA INOX CIJEV (AISI 316L) MF015 S00 DN 25 L=100m ART.422A	m
	0722037	NIKLOVANI HOLENDER 1/2" (DN12) ZA FENKOJLERE I SOLARNE SISTEME ART.419A	m
	0722036	NIKLOVANI HOLENDER 3/4" (DN16) ZA FENKOJLERE I SOLARNE SISTEME ART.430A	m
	0722035	NIKLOVANI HOLENDER 1" (DN20) ZA FENKOJLERE I SOLARNE SISTEME ART.431A	m
	0722030	NIKLOVANI HOLENDER 5/4" ZA FENKOJLERE I SOLARNE SISTEME ART.432A	Kom
	0722033	MESINGANI PUSH FIT 1" (DN25) MUŠKI ZA SOLARNE SISTEME ART.415	Kom
	0722034	MESINGANI PUSH FIT 1" (DN25) ŽENSKI ZA SOLARNE SISTEME ART.418	Kom
	0722040	MESINGANI NIPL 1/2"x1/2" ZA FENKOJLERE I SOLARNE SISTEME ART.418A	Kom
	0722011	MESINGANI NIPL 3/4"x3/4"ZA FENKOJLERE I SOLARNE SISTEME ART.450	Kom
	0722015	MESINGANI NIPL 1"x1"ZA FENKOJLERE I SOLARNE SISTEME ART.451	Kom
	0722042	MESINGANI NIPL 5/4"x5/4" ZA FENKOJLERE I SOLARNE SISTEME ART.452	Kom
	0722017	MESINGANI NIPL 3/4"x1" AN REDUCIRANI ZA FENKOJLERE I SOLARNE SISTEME ART.455	Kom

	Š.Vokel	Opis	Jed.mj.
	0722026	MESINGANA REDUKCIJA M1"-Ž3/4" ZA SOLARNE SISTEME ART.466	Kom
	0722028	MESINGANA REDUKCIJA Ž1"-M3/4" ZA SOLARNE SISTEME ART.465	Kom
	0722027	REDUKCIJA Cu 22-3/4" HOLENDER UNUTARNJI NAVOJ ZA SOLARNE SISTEME ART.467	Kom
	0722038	INOX SEGMENTNI PRSTEN ZA FLEXIBILNE INOX CIJEVI DN 12 ART.439	Kom
	0722010	INOX SEGMENTNI PRSTEN ZA FLEXIBILNE INOX CIJEVI DN 16 ART.440	Kom
	0722014	INOX SEGMENTNI PRSTEN ZA FLEXIBILNE INOX CIJEVI DN 20 ART.441	Kom
	0722031	INOX SEGMENTNI PRSTEN ZA FLEXIBILNE INOX CIJEVI DN 25 ART.442	Kom
	0722039	DIHTUNG KLINGERIT HT ZA INOX FLEXIBILNE CIJEVI DN12 (1/2") ART.459	Kom
	0722012	DIHTUNG KLINGERIT HT ZA INOX FLEXIBILNE CIJEVI DN16GR (3/4") ART.460	Kom
	0722016	DIHTUNG KLINGERIT HT ZA INOX FLEXIBILNE CIJEVI DN20GR (1") ART.461	Kom
	0722032	DIHTUNG KLINGERIT HT ZA INOX FLEXIBILNE CIJEVI DN25 (5/4") ART.462	Kom
	0722022	REZAČ FLEXIBILNIH INOX CIJEVI DO DN 25 ART.475	Kom
	0722023	ALAT ZA POVEZIVANJE FLEXIBILNIH INOX CIJEVI OD DN12 DO DN25 ART.470	Kom
	0722020	ALAT ZA PORAVNAVANJE INOX FLEXIBILNE CIJEVI DN 16 ART.476	Kom
	0722024	NASTAVAK DN16 ALATA ZA POVEZIVANJE FLEXIBILNIH INOX CIJEVI ART.472	Kom
	0722023	ALAT ZA POVEZIVANJE FLEXIBILNIH INOX CIJEVI OD DN12 DO DN25 ART.470	Kom
	0722021	ALAT ZA PORAVNAVANJE INOX FLEXIBILNE CIJEVI DN 20 ART.477	Kom
0722025	NASTAVAK DN20 ALATA ZA POVEZIVANJE FLEXIBILNIH INOX CIJEVI ART.473	Kom	



	VOKEL ŠIFRA	OPIS	ŠIFRA ARTIKLA
	<b>1405005</b>	ORMARIĆ PODŽBUKNI SWPSE-4 H=560, L=350	1300Z
	<b>1405001</b>	ORMARIĆ PODŽBUKNI SWPSE-6 H=560-660, L=450	1310Z
	<b>1405002</b>	ORMARIĆ PODŽBUKNI SWPSE-8/3 H=560-660, L=580	1320Z
	<b>1405003</b>	ORMARIĆ PODŽBUKNI SWPSE-10/7 H=560-660 L=780	1330Z
	<b>1405004</b>	ORMARIĆ PODŽBUKNI SWPSW-13/10 H=560-660 L=930	1340Z
	<b>1405062</b>	ORMARIĆ PODŽBUKNI SWPS-4 H=680-780 L=350	1300S
	<b>1405063</b>	ORMARIĆ PODŽBUKNI SWPS-6 H=680-780 L=450	1310S
	<b>1405064</b>	ORMARIĆ PODŽBUKNI SWPS-8/3 H=680-780 L=580	1320S
	<b>1405065</b>	ORMARIĆ PODŽBUKNI SWPS-10/7 H=680-780 L=780	1330S
	<b>1405066</b>	ORMARIĆ PODŽBUKNI SWPS-13/10 H=680-780 L=930	1340S
	<b>1405072</b>	ORMARIĆ PODŽBUKNI SLIM+ D=110-160, H=750-850 L=1200	1414183023

	<b>1407011</b>	RUBNA TRAKA S PREPUSTOM 8x150 (KOLUT=25 met.)	ART.0.1021
	<b>1424076</b>	SPOJNICA EUROKONUS ZA CIJEVI 16x2	ART.901008N
	<b>1407012</b>	SPOJNICA 16x2 ZA CIJEVI ZA PODNO GRIJANJE	ART.901414
	<b>1406009</b>	BLIND ČEP MESING G 1/2" S GUMICOM	ART.609534
	<b>0697153</b>	SPOJNICA, PRES KAN-therm Ø 15	ART.6201448
	<b>0697154</b>	SPOJNICA, PRES KAN-therm Ø 18	ART.6201459
	<b>0697155</b>	SPOJNICA, PRES KAN-therm Ø 22	ART.6240058
	<b>0697156</b>	SPOJNICA, PRES KAN-therm Ø 28	ART.6240069
	<b>1424077</b>	VANJSKA OPRUGA ZA SAVIJANJE CIJEVI Ø 16	ART.SZ-1612
	<b>1424078</b>	VANJSKA OPRUGA ZA SAVIJANJE CIJEVI Ø 20	ART.SZ-2016
	<b>1424079</b>	VANJSKA OPRUGA ZA SAVIJANJE CIJEVI Ø 26	ART.SZ-2620
	<b>1424080</b>	UNUTARNJA OPRUGA ZA SAVIJANJE CIJEVI Ø 16	ART.SW-1612
	<b>1424081</b>	UNUTARNJA OPRUGA ZA SAVIJANJE CIJEVI Ø 20	ART.SW-2016
	<b>1424082</b>	UNUTARNJA OPRUGA ZA SAVIJANJE CIJEVI Ø 26	ART.SW-2620
	<b>1424084</b>	SPOJNICA UN 20x3/4" KAN THERM	ART.K080253
	<b>1424083</b>	SPOJNICA UN 26x3/4" KAN THERM	ART.K080108
	<b>1405047</b>	ELEKTRO POGON ZA RAZDJELNIKE (SERVO MOTOR) KAN THERM 230V	ART.K800011
	<b>1405061</b>	ELEKTRO POGON ZA RAZDJELNIKE (SERVO MOTOR) KAN THERM 24V	ART.K800013

## RAZDJELNIK S MJERAČEM PROTOKA I SERVOMOTORNIM VENTILIMA

INOX, EUROKONUS 3/4"



ŠIFRA VOKEL	DIMENZIJA	BROJ IZLAZA	ART.
<b>1479001</b>	1"x3/4"	2	1316157066
<b>1479002</b>	1"x3/4"	3	1316157067
<b>1479003</b>	1"x3/4"	4	1316157068
<b>1479004</b>	1"x3/4"	5	1316157069
<b>1479005</b>	1"x3/4"	6	1316157070
<b>1479006</b>	1"x3/4"	7	1316157071
<b>1479007</b>	1"x3/4"	8	1316157072
<b>1479008</b>	1"x3/4"	9	1316157073
<b>1479009</b>	1"x3/4"	10	1316157074
<b>1479010</b>	1"x3/4"	11	1316157075
<b>1479011</b>	1"x3/4"	12	1316157076

## RAZDJELNIK S VENTILIMA

INOX, EUROKONUS 3/4"

\* Raspon protoka između 0 - 2,5 l/min

\* Odgovarajući adapteri M 30x1,5



ŠIFRA VOKEL	DIMENZIJA	BROJ IZLAZA	ART.
<b>1479017</b>	1"x3/4"	2	1316160033
<b>1479018</b>	1"x3/4"	3	1316160034
<b>1479019</b>	1"x3/4"	4	1316160035
<b>1479020</b>	1"x3/4"	5	1316160036
<b>1479021</b>	1"x3/4"	6	1316160037
<b>1479022</b>	1"x3/4"	7	1316160038
<b>1479023</b>	1"x3/4"	8	1316160039
<b>1479024</b>	1"x3/4"	9	1316160040
<b>1479025</b>	1"x3/4"	10	1316160041
<b>1479026</b>	1"x3/4"	11	1316160042
<b>1479027</b>	1"x3/4"	12	1316160043



Završni T komad za razdjelnike - troputi

ŠIFRA VOKEL	DIMENZIJA	ART.
<b>1405054</b>	G1" / G½ / G½	1300257001



Završni T komad za razdjelnike - troputi

ŠIFRA VOKEL	DIMENZIJA	ART.
<b>1405055</b>	G1"	1300257002



Završni inox T komad za razdjelnike - troputi

ŠIFRA VOKEL	DIMENZIJA	ART.
<b>1479012</b>	G1"	1300257004



Pumpa sa troputim mješajućim ventilom

ŠIFRA VOKEL	ART.
<b>1479013</b>	1346103005





T-komad zidni

ŠIFRA VOKEL	DIMENZIJA	PAK/KOM malo/veliko	ART.
<b>1424112</b>	20x1/2"	5/40	1009285057

VRTNA SLAVINA OTPORNA NA SMRZAVANJE



ŠIFRA VOKEL	DIMENZIJA	PAK/KOM malo/veliko	ART.
<b>1424111</b>	16	1/10	1709277001

	ŠIFRA VOKEL	OPIS	ART.
	<b>0615195</b>	RAZDJELNIK 1" 2 IZLAZA	662625
	<b>0615196</b>	RAZDJELNIK 1" 3 IZLAZA	662635
	<b>0615197</b>	PREMOSNICA (BY-PAS) ZA PRIMARNI DIO TERMIČKE JEDINICE	182001



	<b>0201420</b>	SITO ZA USISNU KORPU 4" ART.102	20/1
	<b>0201421</b>  <b>0201422</b>	NEPOVRATNI VENTIL 3/4" ART. BLOCK 101  NEPOVRATNI VENTIL 1" ART. BLOCK 101	204/12  160/10
	<b>0201423</b>	REGULATOR TLAKA 3/4" ART.361	44/4
	<b>0201424</b>	VENTIL S PRIKLJUČKOM 1/2" ART.392	160/10
	<b>0710122</b>  <b>0710123</b>	OZRAČNI LONČIĆ 3/8" ART.363  OZRAČNI LONČIĆ 1/2" ART.363	120/10  120/10
	<b>0696081</b>	POKAZIVAČ TLAKA Ø 63 1/4" 0-10 bar ART.483	136/4

	<b>0686029</b>	RUČNI VENTIL DN15 KUTNI	ART.016102000
	<b>0686030</b>	RUČNI VENTIL DN15 RAVNI	ART.016202000
	<b>0686046</b>	PRIGUŠNICA KUTNA 3/4"	ART.35503000
	<b>0686045</b>	PRIGUŠNICA RAVNA 3/4"	ART.35603000
	<b>0686044</b>	TERMOSTATSKI VENTIL KUTNI 3/4"	ART.220103000
	<b>0686047</b>	TERMOSTATSKI VENTIL RAVNI 3/4"	ART.220203000
	<b>0686038</b>	VENTIL E-Z KUTNI ZA DVOCIJEVNI SISTEM	ART.387902000
	<b>0686053</b>	TERMOSTATSKI VENTIL RAVNI 1/2" S PREDNAMJEŠTANJEM	ART.345202000
	<b>0686054</b>	TERMOSTATSKI VENTIL KUTNI 1/2" S PREDNAMJEŠTANJEM	ART.345102000
	<b>0686026</b>	TERMOSTATSKA GLAVA DX	ART.670000500
	<b>0686052</b>	TERMOSTATSKA GLAVA D-U	ART.685200500
	<b>0686023</b>	TERMOSTATSKA GLAVA WK	ART.730000500

	<b>0686037</b>	TERMOSTATSKA GLAVA VDX	ART.674000500
	<b>0686048</b>	ELEKTRO MOTOR EMO T 230 V BEZ STRUJE OTVOREN	ART.183500500, 180900500
	<b>0686051</b>	TERMOSTATSKA GLAVA SA SENZOROM 40-70	ART.660200500
	<b>0686025</b>	TERMOSTATSKA GLAVA SA SENZOROM 20-50 (S podnožjem koje provodi toplinu i elementom za pričvršćivanje)	ART.640200500
	<b>0686031</b>	H-VENTIL DVOCJEVNI RAVNI 3/4"	ART.55250000, 56250000
	<b>0686032</b>	H-VENTIL DVOCJEVNI KUTNI 3/4"	ART.55350000
	<b>0686033</b>	SET 5 (DX GLAVA+VEKOTEC 1/2" RAVNI)	ART.DXVTECP12
	<b>0686041</b>	SET 7 (DX GLAVA+VEKOTEC 3/4" RAVNI)	ART.DXVTECP34
	<b>0686040</b>	SET 6 (DX GLAVA+VEKOTEC 1/2" KUTNI)	ART.DXVTECK12
	<b>0686042</b>	SET 8 (DX GLAVA+VEKOTEC 3/4" KUTNI)	ART.DXVTECK34
	<b>0686058</b>	SET VENTIL TERMOSTATSKI RAVNI 1/2" + DU GLAVA	ART.969618800
	<b>0686057</b>	SET VENTIL TERMOSTATSKI KUTNI 1/2" + DU GLAVA	ART.969617800



VOKEL ŠIFRA	OPIS	PAKIRANJE (kom)	ARTIKAL
<b>0496004</b>	ČEP ZA ISPITIVANJE INSTALACIJA 1/2"	50	122



VOKEL ŠIFRA	OPIS	DIMENZIJA (Ø)	PAKIRANJE (kom)	ARTIKAL
<b>0496007</b>	DRŽAČ CIJEVI DVOSTRANI	8x80	50	130



VOKEL ŠIFRA	OPIS	DIMENZIJA (Ø)	PAKIRANJE (kom)	ARTIKAL
<b>0496008</b>	DRŽAČ CIJEVI JEDNOSTRANI	8x80	50	129



VOKEL ŠIFRA	OPIS	PAKIRANJE (kom)	ARTIKAL
<b>0496009</b>	KONUSNO RAVNALO - KAJLA	100	136



VOKEL ŠIFRA	OPIS	DIMENZIJA (mm)	PAKIRANJE (kom)	ARTIKAL
<b>0496011</b>	PODLOŠKA ZA RAVNANJE	1	100	140
<b>0496012</b>	PODLOŠKA ZA RAVNANJE	1,6	100	135

## KVALITETA / TEHNOLOGIJA / PROIZVODNJA



**MADE IN ITALY**

Svestran i kompletan sustav za sigurno rješenje problema na vanjskim površinama na jednostavan način i bez rušenja. Širok raspon rješenja koji odgovaraju za najveći dio problematičnih situacija koje nastaju na gradilištima te prilikom restrukturiranja postojećih situacija. Naši nosači omogućuju da odaberete najbolje rješenje ovisno o vrsti površine:

drvo, kompozitno drvo, keramika, mramor ili granit. Automatizirana proizvodnja koja osigurava maksimalnu kontrolu kvalitete, elastičnost i personalizaciju proizvoda te oprezan izbor dobavljača sirovina za inovativne proizvode, naši su novi ciljevi koji jamče kontinuirano i stalno unapređenje naših nosača

### SVE PREDNOSTI SUSTAVA

Naši nosači su dizajnirani za vanjsko popločavanje s odličnim rezultatima u smislu snage i izdržljivosti. Idealno za terase, područja oko bazena, šetnice na krovovima i visećim vrtovima, može se postavljati izravno na staru podlogu.

Prednost je ogromna u smislu troškova izgradnje, rokova isporuke i nema bespotrebnih sanacija hidroizolacija jer je sustav moguće ugraditi bez rušenja.

Savršeno niveliranje završenih podova 01

Jednostavno i brzo polaganje 02

Olakšani završeni podovi 03

Pregled bez rušenja 04

Prolaz instalacija ispod poda 05





## FIKSNI NOSAČI DRŽAČI FIKSNE VISINE

FIKSNI DRŽAČI koriste se za pokrivanje minimalne kvote i kada svojstva terase ne dopuštaju veće visine kao što je, na primjer, kada je prag vrata vrlo nisko.

DRŽAČI FIKSNE VISINE



MINI ELASTIČNI



Oba držača fiksne visine podržavaju sustav i podesive visine, oni omogućuju dovoljnu pokrivenost visina. Korištenje nivelira i proširenje obogaćuju ponudu, optimiziraju zalihe komada u skladištu.

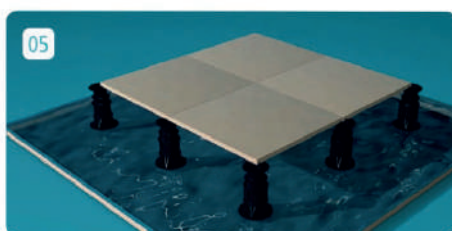
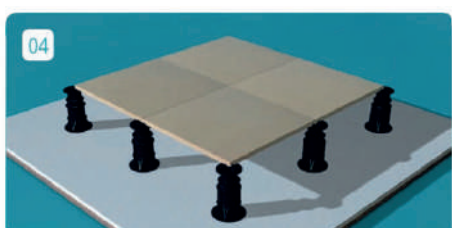
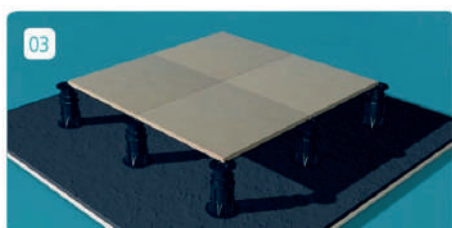
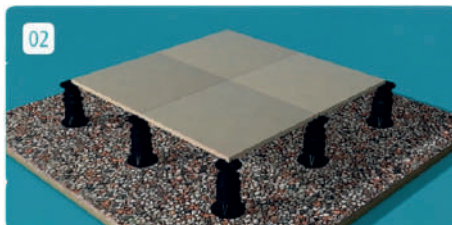
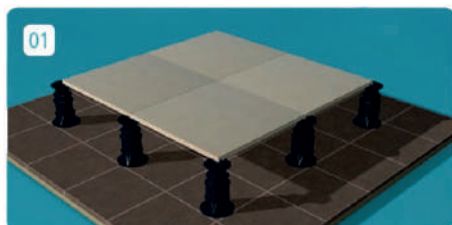

PRIMJENA DRŽAČA FIKSNE VISINE I DRŽAČA PODESIVE VISINE

- 01 Polaganje na postojeći pod
- 02 Polaganje na stabilizirani šljunak
- 03 Polaganje na bitumenske membrane
- 04 Polaganje na tekuću hidroizolaciju - sintetički filc
- 05 Polaganje za fontane i vodovode

### DRŽAČI FIKSNE VISINE

#### ELASTIČNI DRŽAČI

Visina od 5 do 14 mm  
Pun kapacitet 1000 kg/komadu

#### DRŽAČI FIKSNE VISINE

Visina od 12 do 19 mm  
Pun kapacitet 1000kg/komadu

### DRŽAČI PODESIVE VISINE

#### MINIMART

Visina od 22 do 37 mm  
Pun kapacitet 400 kg/komadu

#### JACK

Visina od 35 do 365 mm  
Pun kapacitet 400kg/komadu

#### XL JACK

Visina od 85 do 380 mm  
Pun kapacitet 400 kg/komadu

#### MEGAMART S

Visina od 121 do 571 mm  
Pun kapacitet 800kg/komadu

#### MEGAMART

Visina od 35 do 1020 mm  
Pun kapacitet 800 kg/komadu

## PODESIVI NOSAČI DRŽAČI PODESIVE VISINE

Podesivi nosači pružaju savršenu ravninu konačnog poda sa svojim jednostavnim i brzim polaganjem. Konačni rezultat je olakšani pod. To uvijek omogućava pregled i popravak bez rušenja u odnosu na standardna polaganja.

Milimetarska prilagodba u konačnici. Sustav je kompatibilan s mnogim vrstama podova: Gres pločice, montažne betonske ploče, prirodni kamen, granit drvo i kompozitno drvo.

MINIMART



JACK



XL JACK



MEGAMART S



MEGAMART



## MINIMART

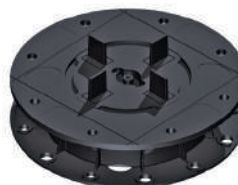
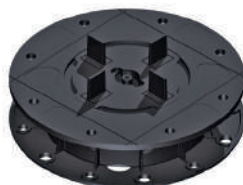

VOKEL ŠIFRA	OPIS	ARTIKAL
<b>1534001</b>	PVC REGULIRAJUĆI NOSAČI ZA PODIGNUTE PODOVE MINIMART 22-30 mm	240-626-001-022
<b>1534002</b>	PVC REGULIRAJUĆI NOSAČI ZA PODIGNUTE PODOVE MINIMART 28-37 mm	240-626-001-028
<b>1534003</b>	PVC REGULIRAJUĆI NOSAČI ZA PODIGNUTE PODOVE MINIMART 35-50 mm	240-356-300-035
<b>1534004</b>	PVC REGULIRAJUĆI NOSAČI ZA PODIGNUTE PODOVE MINIMART 50-70 mm	240-356-300-050
<b>1534005</b>	PVC REGULIRAJUĆI NOSAČI ZA PODIGNUTE PODOVE MINIMART 65-100 mm	240-356-300-065
<b>1534006</b>	PVC REGULIRAJUĆI NOSAČI ZA PODIGNUTE PODOVE MINIMART 95-130 mm	240-356-300-095
<b>1534007</b>	PVC REGULIRAJUĆI NOSAČI ZA PODIGNUTE PODOVE MINIMART 125-160 mm	240-356-300-125
<b>1534008</b>	PVC REGULIRAJUĆI NOSAČI ZA PODIGNUTE PODOVE MINIMART 155-190 mm	240-356-300-155
<b>1534009</b>	PVC REGULIRAJUĆI NOSAČI ZA PODIGNUTE PODOVE MINIMART 185-220 mm	240-356-300-185



	ŠIFRA VOKEL	OPIS	DIMENZIJE	PROTOK	ARTIKAL
	<b>1170002</b>	PERLATOR ZA UMIVAONIK ANTI KAMENAC, SAMOČIŠĆENJE (SLC, AC)	M24x1	13.5 - 15.0 L/Min	10850298
	<b>1170001</b>	PERLATOR ZA KUHINJU ANTI KAMENAC, SAMOČIŠĆENJE (SLC, AC)	M22x1	13.5 - 15.0 L/Min	10850198
	<b>1170003</b>	PERLATOR SSR ZA UMIVAONIK, PODEŠAVANJE KUTA PROTOKA	M24x1	13.5 - 15.0 L/Min	10753398
	<b>1170004</b>	PERLATOR SSR ZA KUHINJU, PODEŠAVANJE KUTA PROTOKA	M22x1	13.5 - 15.0 L/Min	10859398
	<b>1170005</b>	PERLATOR SIGURNOSNI ZA UMIVAONIK, PROTIV KRAĐE, SAMOČIŠĆENJE (SLC, AC)	M24x1	13.5 - 15.0 L/Min	10851198
	<b>1170006</b>	PERLATOR SIGURNOSNI ZA KUHINJU PROTIV KRAĐE, SAMOČIŠĆENJE (SLC, AC)	M22x1	13.5 - 15.0 L/Min	10851098
	<b>1170007</b>	ŠTEDNI PERLATOR SA 3-LED BOJE (zelena, žuta, crvena)	M22x1/ M24x1	7.5 L/Min	70762798
	<b>1170008</b>	PERLATOR ZA BATERIJE SA 3 CIJEVI, ZA PROTOČNI BOJLER	M24x1	Puni protok	10855198
	<b>1170009</b>	PERLATOR ZA BATERIJE SA 3 CIJEVI, ZA PROTOČNI BOJLER	M22x1	Puni protok	10855098



	ŠIFRA VOKEL	OPIS	DIMENZIJE	PROTOK	ARTIKAL
	<b>1170010</b>	ŠTEDNI PERLATOR ZA KUHINJU S CRIJEVOM	M22x1/ M24x1	9.5 L/Min	70324198
	<b>1170011</b>	REGULATOR PROTOKA PCW-02 ZA TUŠ RUČICU	M22X1/ M24X1	7 L/Min	70753098
	<b>1170012</b>	PERLATOR ZA KADU	M28x1	27.0 - 30.0 L/Min	02045598
	<b>1170013</b>	ŠTEDNI PERLATOR ZA UMIVAONIK	M24x1	8.3 L/Min	02048598
	<b>1170014</b>	ŠTEDNI PERLATOR ZA KUHINJU	M22x1	8.3 L/Min	02048098
	<b>1170015</b>	ŠTEDNI UMETAK ZA PERLATOR	M22/ M24	8.3 L/Min	02049098
	<b>1170016</b>	ŠTEDNI PERLATOR SA CRIJEVOM	M22x1/ M24x1	8.3 L/Min	02045998
	<b>1170017</b>	PERLATOR ZA KUHINJU	M22x1/ M24x1	9.5 L/Min	02046998
	<b>1170018</b>	PERLATOR ZA KUHINJU NARANČASTI	M22x1/ M24x1	15 L/Min	07214498

	ŠIFRA VOKEL	OPIS	DIMENZIJE	PROTOK	ARTIKAL
	<b>1170019</b>	PERLATOR ZA KUHINJU ZELENI	M22x1/ M24x1	15 L/Min	07214298
	<b>1170020</b>	PERLATOR ZA KUHINJU LJUBIČASTI	M22x1/ M24x1	15 L/Min	07215098
	<b>1170021</b>	PERLATOR ZA KUHINJU	M22x1	Puni protok	40502195
	<b>1170022</b>	PERLATOR ZA UMIVAONIK	M24x1	Puni protok	40502295
	<b>1170023</b>	UMETAK ZA PERLATOR	M22/ M24	Puni protok	40502395
	<b>1170024</b>	ŠTEDNI PERLATOR ZA UMIVAONIK ANTI KAMENAC, SAMOČIŠČENJE (SLC, AC)	M24x1	5 L/Min	02735297
	<b>1170025</b>	PERLATOR ZA UMIVAONIK PCA, PRSKANJE "RAIN SPRAY"	M22X1	3,8 L/Min	70589498
	<b>1170026</b>	ŠTEDNI PERLATOR ZA UMIVAONIK PCA, PRSKANJE "RAIN SPRAY"	M24X1	3,8 L/Min	70589598



## NEOPERL® Aerators

**Perlatori --- ključna komponenta svake baterije (slavine)**

- o stvara mekan stabilan protok bez popratnog prskanja
- o oblikuje tok vode koja izlazi iz slavine
- o ušteda vode i smanjenje troškova energije
- o smanjenje razine buke slavine
- o u skladu sa lokalnim propisima, standardima i zakonima



Kućište



Umetak



Gumica za bateriju

**Veličine i navoji**

ŽENSKI M22



MUŠKI M24

MUŠKI M28  
Posebno za kadu

## Montaža i demontaža

Uz pomoć ključa

(pogodno za M22, M24, i M28)



## Maximalna zaštita od kamenca

o **Smart lime cleaning (SLC)** za maksimalan životni vijek perlatora baterije: samo protrljate kase nac sa prstom, te je protok vode ponovno ravan i mekan !



## Funkcija Automatskog Čišćenja

o **Auto - Clean funkcija (AC)** male čestice prljavštine dimenzije do 0,7 mm u vodi su jednostavno isprane !

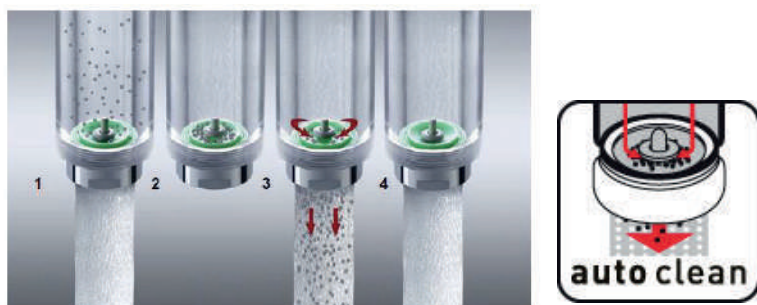

SSR Perlatori

Kut protoka vode se može direktno namjestiti na perlatoru jednostavno pomjerajući prilagodljivu nagibnu pločicu +/-7°



U pojedinim slučajevima umivaonici i izlaz vode na bateriji nisu proporcijalni, stoga pozicija toka vode nije idealna. Rješenje za probleme kod mnogih ne dobrih kombinacija umivaonik/baterija.

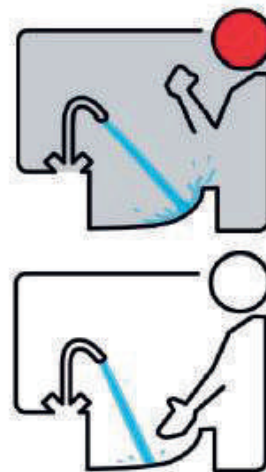

Pojedine kombinacije umivaonika i baterija proizvode prskanje vode. SSR perlator prilagođava tok vode da direktno pogodi idealnu točku bez potrebe mijenjanja umivaonika ili baterije.

## PERLATOR ZA KUHINJU

Perlator za kuhinju sa 2 različita izlaza vode



Dostupno u različitim bojama



### Perlator sa LED svjetlom (3 boje----- boje semafora)

- Koristeći princip boje svjetla kao kod semafora, pomaže da se voda pusti samo kada je potrebno.
- Zelena boja: za prvih 15 sekundi LED perlator svjetli u zelenoj boji
- Žuta boja: Nakon prvih 15 sekundi, led perlator postaje žut
- Crvena boja: Nakon 20 sekundi, LED perlator pocrveni i potom nakon 5 sekundi počinje da blješti



### PCW02 --- UŠTEDA VODE KOD TUŠ RUČICE

- Ušteda vode za tuš ručicu, savršeno kao dodatak
- Samo zamijeniti postojeću gumicu kod tuš ručice sa PCW02. To je zatvaranje i ušteda vode u jednom.



# Katalog proizvoda



**NEOPERL®**

flow, stop and go®





**FIL-NOX**  
**FLEX-CIJEV**

VOKEL ŠIFRA	DIMENZIJA (")	DULJINA (cm)	ARTIKAL
<b>0159001</b>	M1/2 - H1/2	30	701030001/8204
<b>0159002</b>	M1/2 - H1/2	35	701035001/8204
<b>0159003</b>	M1/2 - H1/2	40	701040001/8204
<b>0159004</b>	M1/2 - H1/2	45	701045001/8204
<b>0159005</b>	M1/2 - H1/2	50	701050001/8204
<b>0159006</b>	M1/2 - H1/2	55	701055001/8204
<b>0169007</b>	M1/2 - H1/2	60	701060001/8204
<b>0159008</b>	M1/2 - H1/2	70	701070001/8204
<b>0159009</b>	M1/2 - H1/2	80	701080001/8204
<b>0159010</b>	M1/2 - H1/2	100	701100001/8240



**FIL-NOX**  
**FLEX-CIJEV**

VOKEL ŠIFRA	DIMENZIJA (")	DULJINA (cm)	ARTIKAL
<b>0159011</b>	H1/2 - H1/2	30	701030005/8204
<b>0159012</b>	H1/2 - H1/2	40	701040005/8204



**FIL-NOX**  
**FLEX-CIJEV**

VOKEL ŠIFRA	DIMENZIJA (")	DULJINA (cm)	ARTIKAL
<b>0159013</b>	H3/8 - H3/8	20	701020006/8204
<b>0159014</b>	H3/8 - H3/8	30	701030006/8204
<b>0159015</b>	H3/8 - H3/8	40	701040006/8204
<b>0159016</b>	H3/8 - H3/8	60	701060006/8204
<b>0159017</b>	H3/8 - H3/8	80	701080006/8204
<b>0159018</b>	H3/8 - H3/8	100	701100006/8204



FIL-NOX

FLEX-CIJEV

VOKEL ŠIFRA	DIMENZIJA (")	DULJINA (cm)	ARTIKAL
<b>0159021</b>	M10x1x35 - H3/8	35	721035091/8204



FIL-NOX GIG

FLEX-CIJEV

VOKEL ŠIFRA	DIMENZIJA (")	DULJINA (cm)	ARTIKAL
<b>0159033</b>	H1 - H1	60	004060037/8204



FIL-NOX GIG

FLEX-CIJEV

VOKEL ŠIFRA	DIMENZIJA (")	DULJINA (cm)	ARTIKAL
<b>0159034</b>	M1 - H1	60	004060037/8204



FIL-NOX GIG - FIL BOR

FLEX-CIJEV

VOKEL ŠIFRA	DIMENZIJA (")	DULJINA (cm)	ARTIKAL
<b>0159043</b>	M1 - COD01	40	004040045/8204
<b>0159044</b>	M1 - COD01	60	004060045/8204



### FIL-NOX GIG

#### FLEX-CIJEV

VOKEL ŠIFRA	DIMENZIJA (")	DULJINA (cm)	ARTIKAL
<b>0159024</b>	H3/4 - CODO3/4	30	705030021-B/R-A
<b>0159035</b>	H1 - CODO1	40	004040046/8204
<b>0159086</b>	H1-CODO1	60	004060046/8204



### FIL-NOX GIG

#### FLEX-CIJEV

VOKEL ŠIFRA	DIMENZIJA (")	DULJINA (cm)	ARTIKAL
<b>0159031</b>	M3/8 - H3/8	10	701010002/8240
<b>0159032</b>	M3/8 - H3/8	20	701020002/8204
<b>0159089</b>	M3/8 - H3/8	30	701030002/8204
<b>0159096</b>	M3/8 - H3/8	40	701040002/8204
<b>0159097</b>	M3/8 - H3/8	50	701050002/8204
<b>0159098</b>	M3/8 - H3/8	60	701060002/8204



### FIL-NOX

#### FLEX-CIJEV ZA SLAVINE

VOKEL ŠIFRA	DIMENZIJA (")	DULJINA (cm)	ARTIKAL
<b>0159045</b>	M10x18 - H1/2	30	721030085
<b>0159046</b>	M10x18 - H1/2	40	721040085
<b>0159047</b>	M10x18 - H1/2	50	721050085
<b>0159048</b>	M10x18 - H1/2	60	721060085
<b>0159049</b>	M10x18 - H1/2	70	721070085



## FIL-NOX

### FLEX-CIJEV ZA SLAVINE

VOKEL ŠIFRA	DIMENZIJA (")	DULJINA (cm)	ARTIKAL
<b>0159050</b>	M10x18 - H3/8	30	721030090
<b>0159051</b>	M10x18 - H3/8	40	721040090
<b>0159052</b>	M10x18 - H3/8	50	721050090
<b>0159053</b>	M10x18 - H3/8	60	721060090
<b>0159054</b>	M10x18 - H3/8	70	721070090



## FIL-NOX

### FLEX-CIJEV ZA SLAVINE

VOKEL ŠIFRA	DIMENZIJA (")	DULJINA (cm)	ARTIKAL
<b>0159055</b>	M10x35 - H1/2	30	721030086
<b>0159056</b>	M10x35 - H1/2	40	721040086
<b>0159057</b>	M10x35 - H1/2	50	721050086
<b>0159058</b>	M10x35 - H1/2	60	721060086
<b>0159059</b>	M10x35 - H1/2	70	721070086



## FIL-NOX

### FLEX-CIJEV ZA SLAVINE

VOKEL ŠIFRA	DIMENZIJA (")	DULJINA (cm)	ARTIKAL
<b>0159060</b>	M10x50 - H3/8	30	721030092
<b>0159061</b>	M10x50 - H3/8	40	721040092
<b>0159062</b>	M10x50 - H3/8	50	721050092
<b>0159063</b>	M10x50 - H3/8	60	721060092



## FIL-NOX

## FLEX-CIJEV ZA SLAVINE

VOKEL ŠIFRA	DIMENZIJA (")	DULJINA (cm)	ARTIKAL
<b>0159064</b>	M10x50 - H1/2	30	721030087
<b>0159065</b>	M10x50 - H1/2	40	721040087
<b>0159066</b>	M10x50 - H1/2	50	721050087
<b>0159067</b>	M10x50 - H1/2	60	721060087



## FIL-NOX

## FLEX-CIJEV ZA SLAVINE

VOKEL ŠIFRA	DIMENZIJA (")	DULJINA (cm)	ARTIKAL
<b>0159068</b>	M8x18 - H1/2	30	721030088
<b>0159069</b>	M8x18 - H1/2	40	721040088
<b>0159070</b>	M8x18 - H1/2	50	721050088
<b>0159071</b>	M8x18 - H1/2	60	721060088



## FIL-NOX

## FLEX-CIJEV ZA SLAVINE

VOKEL ŠIFRA	DIMENZIJA (")	DULJINA (cm)	ARTIKAL
<b>0159074</b>	M8x18 - H3/8	50	721050093
<b>0159075</b>	M8x18 - H3/8	60	721060093



## FIL-NOX GIG

## FLEX-CIJEV

VOKEL ŠIFRA	DIMENZIJA (")	DULJINA (cm)	ARTIKAL
<b>0159088</b>	M1/2 - H3/4	60	705060025/8204





**FIL-NOX**  
FLEX-CIJEV S NASTAVKOM ZA KLJUČ

VOKEL ŠIFRA	DIMENZIJA (")	DULJINA (cm)	ARTIKAL
<b>0159080</b>	M1/2 - H1/2	30	701030001/8204A
<b>0159081</b>	M1/2 - H1/2	35	701035001/8204A
<b>0159082</b>	M1/2 - H1/2	40	701040001/8204A
<b>0159083</b>	M1/2 - H1/2	45	701045001/8204A
<b>0159085</b>	M1/2 - H1/2	50	701050001/8204A



**ROZETA**  
ZA FLEX CIJEVI

VOKEL ŠIFRA	ARTIKAL
<b>0159084</b>	FLO350002



**FIL-NOX GIG**  
FLEX-CIJEV

VOKEL ŠIFRA	DIMENZIJA (")	DULJINA (cm)	ARTIKAL
<b>0159022</b>	H3/4 - H3/4	30	705030029/8204
<b>0159090</b>	H3/4 - H3/4	50	705050029/8204
<b>0159091</b>	H3/4 - H3/4	70	705070029/8204
<b>0159092</b>	H3/4 - H3/4	100	705100029/8204



**FIL-NOX GIG**  
FLEX-CIJEV

VOKEL ŠIFRA	DIMENZIJA (")	DULJINA (cm)	ARTIKAL
<b>0159023</b>	M3/4 - H3/4	30	705030026/8204
<b>0159093</b>	M3/4 - H3/4	50	705050026/8204
<b>0159094</b>	M3/4 - H3/4	70	705070026/8204
<b>0159095</b>	M3/4 - H3/4	100	705100026/8204



### FIL-NOX

FLEX-CIJEV MATEU

VOKEL ŠIFRA	DIMENZIJA (")	DULJINA (cm)	ARTIKAL
<b>0159019</b>	H3/8-H1/2	30	701030007/8204
<b>0159020</b>	H3/8-H1/2	40	701040007/8204



### TUŠ CRIJEVO

S PREKIDAČ RUČICOM

VOKEL ŠIFRA	BOJA	ARTIKAL
<b>0159026</b>	KROM	AQA004006



### FLEX CIJEV

RASTEZLJIVA

VOKEL ŠIFRA	DIMENZIJA (cm)	ARTIKAL
<b>0159027</b>	150 - 190	FLE150300



### PRIKLJUČNO CRIJEVO

ZA VEŠ MAŠINU

VOKEL ŠIFRA	DIMENZIJA (cm)	ARTIKAL
<b>0159030</b>	150	CLA201001



## KOMBINIRANI KUTNI VENTIL

1/2" x 3/4" x 3/8"

- anti kamenac
- dvije ručice
- 4 nezavisne pozicije

ŠIFRA VOKEL	OPIS	ŠIFRA ARTIKLA
<b>0309001</b>	KOMBINIRANI KUTNI VENTIL 1/2" x 3/4" x 3/8"	COMB5MAC



## PRIKLJUČAK ZA PERILICU

1/2" x 3/4"

- anti kamenac
- plavi index

ŠIFRA VOKEL	OPIS	ŠIFRA ARTIKLA
<b>0309002</b>	PRIKLJUČAK ZA PERILICU 1/2" x 3/4"	AC728A



## KUTNI VENTIL S FILTEROM

1/2" x 3/4"

- anti kamenac
- mini filter MAC

ŠIFRA VOKEL	OPIS	ŠIFRA ARTIKLA
<b>0309003</b>	KUTNI VENTIL S FILTEROM 1/2" x 3/8"	02402MAC



## KUTNI VENTIL

1/2" x 3/8"

- anti kamenac
- s metalnom ručicom

ŠIFRA VOKEL	OPIS	ŠIFRA ARTIKLA
<b>0309004</b>	KUTNI VENTIL 1/2" x 3/8"	NOV77MAC

## KUTNI VENTIL DUŽI

1/2" x 3/8"



- anti kamenac
- s metalnom ručicom

ŠIFRA VOKEL	OPIS	ŠIFRA ARTIKLA
<b>0309005</b>	KUTNI VENTIL DUŽI 1/2" x 3/8"	NOV88MAC

### KUTNI VENTIL S DVA PRIKLJUČKA

1/2" x 3/4" x 3/8"



- anti kamenac
- jedna ručica
- 4 nezavisne pozicije

ŠIFRA VOKEL	OPIS	ŠIFRA ARTIKLA
<b>0309006</b>	KUTNI VENTIL S DVA PRIKLJUČKA 1/2" x 3/8" x 3/8"	CQ4102

### KUTNI VENTIL ZENIT

1/2" x 3/8"



- anti kamenac

ŠIFRA VOKEL	OPIS	ŠIFRA ARTIKLA
<b>0309007</b>	KUTNI VENTIL ZENIT 1/2" x 3/8"	Z0900

### KUGLASTA SLAVINA DUPLA

1/2" x 3/4" x 3/4"



- anti kamenac
- tijelo iz jednog komada
- bez curenja

ŠIFRA VOKEL	OPIS	ŠIFRA ARTIKLA
<b>0309008</b>	KUGLASTA SLAVINA DUPLA 1/2" x 3/4" x 3/4"	00472

### KUGLASTA SLAVINA

1/2" x 3/4"



- anti kamenac
- s metalnom ručicom

ŠIFRA VOKEL	OPIS	ŠIFRA ARTIKLA
<b>0309009</b>	KUGLASTA SLAVINA 1/2" x 3/4"	00413

### REDUKCIJA Ž x M

1/2" x 3/4"



- anti kamenac

ŠIFRA VOKEL	OPIS	ŠIFRA ARTIKLA	PAK. (kom/kutija)
<b>0309010</b>	REDUKCIJA Ž 3/8" x M 1/2"	COMBI88U	20
<b>0309011</b>	REDUKCIJA Ž 3/8" x M 3/4"	COMBI89U	20



### SLAVINA ZA PUNJENJE I PRAŽNENJE

1/2"

ŠIFRA VOKEL	OPIS	ŠIFRA ARTIKLA	PAK. (kom/kutija)
<b>0309012</b>	SLAVINA ZA PUNJENJE I PRAŽNENJE 1/2"	504220	35

### KUTNI VENTIL LIPSTIK

1/2" x 3/8"



- ukrasni kutni ventil

ŠIFRA VOKEL	OPIS	ŠIFRA ARTIKLA
<b>0309013</b>	KUTNI VENTIL LIPSTIK 1/2" x 3/8"	202501

### KUTNI VENTIL + FLEX CRIJEVO ZA BATERIJU

F3/8 x F3/8 30cm



- Set: kutni ventil + ukrasno flex crijevo za bateriju

ŠIFRA VOKEL	OPIS	ŠIFRA ARTIKLA
<b>0728114</b>	KUTNI VENTIL+FLEX CRIJEVO ZA BATERIJU F3/8 x F3/8 30cm	FVL012





## NTS LIME

CRIJEVO OTPORNO NA PREGIBANJA



VOKEL ŠIFRA	DIMENZIJA	PAKIRANJE (m)	ARTIKAL
<b>0161034</b>	1/2"	15	761951661559001
<b>0161023</b>	1/2"	25	761951662559001
<b>0161024</b>	1/2"	50	761951665059001
<b>0161022</b>	3/4"	25	761953062559001
<b>0161025</b>	3/4"	50	761953065059000



## NTS JEANS

CRIJEVO OTPORNO NA PREGIBANJA



VOKEL ŠIFRA	DIMENZIJA	PAKIRANJE (m)	ARTIKAL
<b>0161031</b>	3/4"	25	761963062559001
<b>0161035</b>	5/8"	25	761962062559001
<b>0161026</b>	1/2"	25	761961662559001
<b>0161027</b>	1/2"	50	761961665059001



## NTS ORANGE

CRIJEVO OTPORNO NA PREGIBANJA



VOKEL ŠIFRA	DIMENZIJA	PAKIRANJE (m)	ARTIKAL
<b>0161032</b>	1/2"	50	761991665059001
<b>0161030</b>	1/2"	15	761991661559001
<b>0161033</b>	3/4"	50	761993065059000
<b>0161028</b>	1/2"	25	761991662559001
<b>0161029</b>	3/4"	25	761993062559001

## SAVRŠENA ZAŠTITA OD KAMENCA



- Štiti grijače i bubanj perilica od kamenca
- Produžuje vijek trajanja i funkcionalnost perilice
- Povećava intezitet pranja - razgrađuje organske mrlje i prljavštinu
- Čuva boju i kvalitetu rublja
- Smanjuje potrošnju sredstva za pranje
- Uz pravilnu upotrebu moguće koristiti do 10 godina.

Š.Vokel	Opis
0526175	KUGLA ZA RAZBIJANJE VODENOG KAMENCA WASHBALL ART.SWB

### Uputstva za uporabu:

- Ubaciti SWISS WASH BALL zajedno sa rubljem u perilicu
- Upotrijebiti 1/3 manje sredstva za pranje od preporučene doze
- Ne upotrebljavati omekšivače vode
- SWISH WASH BALL ne treba održavanje
- SWISH WASH BALL je izdrživ do 100°C

### Napomena:

Nemojte zaboraviti redovno čistiti filtere perilice a udaranje SWISH WASH BALL ne oštećuje kako bubanj tako ni rublje. Možete ga upotrebljavati kako u perilicama tako i u vodokotliću. Jednostavno stavite kuglu u košaru perilice ili je ubacite unutar vodokotlića.

### Perilice rublja / Perilice posuđa / Vodokotlići



**KOLJENO M-Ž**

KROMIRANO



ŠIFRA VOKEL	VELIČINA ["]	ŠIFRA ARTIKLA
<b>0203037</b>	3/8	45138
<b>0203038</b>	1/2	45112
<b>0203039</b>	3/4	45134
<b>0203118</b>	1	45110

**KOLJENO Ž-Ž**

KROMIRANO



ŠIFRA VOKEL	VELIČINA ["]	ŠIFRA ARTIKLA
<b>0203040</b>	3/8	45238
<b>0203041</b>	1/2	45212
<b>0203042</b>	3/4	45234
<b>0203119</b>	1	45210

**T-KOMAD**

KROMIRANI

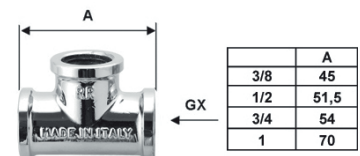

ŠIFRA VOKEL	VELIČINA ["]	ŠIFRA ARTIKLA
<b>0203043</b>	3/8	45338
<b>0203044</b>	1/2	45312
<b>0203045</b>	3/4	45334
<b>0203120</b>	1	45310

**MUFNA**

KROMIRANA



ŠIFRA VOKEL	VELIČINA ["]	ŠIFRA ARTIKLA
<b>0203046</b>	3/8	45438
<b>0203047</b>	1/2	45412
<b>0203048</b>	3/4	45434
<b>0203121</b>	1	45410

**PRODUŽETAK 3/4"**

KROMIRANI

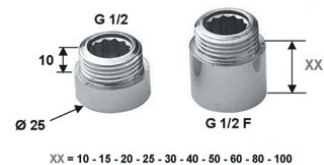

XX = 10 - 15 - 20 - 25 - 30 - 40 - 50 - 60 - 80 - 100

ŠIFRA VOKEL	VELIČINA ["]	ŠIFRA ARTIKLA
<b>0203122</b>	3/4 x 10	5023410
<b>0203123</b>	3/4 x 15	5023415
<b>0203124</b>	3/4 x 20	5023420
<b>0203125</b>	3/4 x 25	5023425
<b>0203126</b>	3/4 x 30	5023430
<b>0203127</b>	3/4 x 40	5023440
<b>0203128</b>	3/4 x 50	5023450

**PRODUŽETAK 1/2"**

KROMIRANI



XX = 10 - 15 - 20 - 25 - 30 - 40 - 50 - 60 - 80 - 100

ŠIFRA VOKEL	VELIČINA ["]	ŠIFRA ARTIKLA
<b>0203129</b>	1/2 x 10	502P1210
<b>0203130</b>	1/2 x 15	502P1215
<b>0203131</b>	1/2 x 20	502P1220
<b>0203132</b>	1/2 x 25	502P1225
<b>0203133</b>	1/2 x 30	502P1230
<b>0203134</b>	1/2 x 40	502P1240
<b>0203135</b>	1/2 x 50	502P1250
<b>0203136</b>	1/2 x 60	502P1260
<b>0203137</b>	1/2 x 80	502P1280
<b>0203138</b>	1/2 x 100	502P12100

**NIPEL**

KROMIRANI

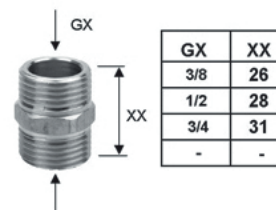

ŠIFRA VOKEL	VELIČINA ["]	ŠIFRA ARTIKLA
<b>0203139</b>	3/8	52038
<b>0203140</b>	1/2	52012
<b>0203141</b>	3/4	52034
<b>0203142</b>	1	52010

## REDUKCIJA

KROMIRANA

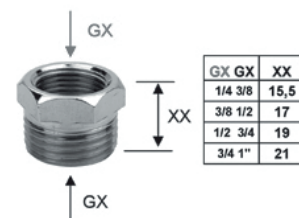

ŠIFRA VOKEL	VELIČINA ["]	ŠIFRA ARTIKLA
<b>0203143</b>	1/4 x 3/8	5111438
<b>0203144</b>	3/8 x 1/2	5113812
<b>0203145</b>	1/2 x 3/4	5111234
<b>0203146</b>	3/4 x 1	5113410

## Y 3/4" F x 3/4" x 3/4"

KROMIRANI

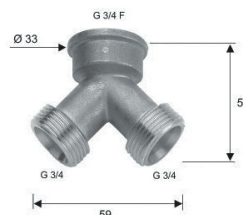

ŠIFRA VOKEL	VELIČINA ["]	ŠIFRA ARTIKLA
<b>0203147</b>	3/4 F x 3/4 x 3/4	209YCR

## ČEP

KROMIRANI



ŠIFRA VOKEL	VELIČINA ["]	ŠIFRA ARTIKLA
<b>0203148</b>	3/8	52338
<b>0203149</b>	1/2	52312
<b>0203150</b>	3/4	52334
<b>0203151</b>	1	52310

## ČEP Ž

KROMIRANI



ŠIFRA VOKEL	VELIČINA ["]	ŠIFRA ARTIKLA
<b>0203152</b>	3/8	52438
<b>0203153</b>	1/2	52412
<b>0203154</b>	3/4	52434
<b>0203155</b>	1	52410



## NASTAVAK ZA SPAJANJE CRIJEVA

UNUTARNJI NAVOJ



ŠIFRA VOKEL	VELIČINA ["]	ŠIFRA ARTIKLA
<b>0203261</b>	½ x Ø14	532

## NASTAVAK ZA SPAJANJE CRIJEVA

VANJSKI NAVOJ

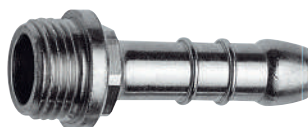

ŠIFRA VOKEL	VELIČINA ["]	ŠIFRA ARTIKLA
<b>0203262</b>	½ x Ø14	531

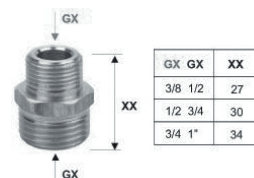
**NIPEL REDUCIRANI**
**MESING**

ŠIFRA VOKEL	VELIČINA ["]	ŠIFRA ARTIKLA
<b>0203232</b>	1/4 x 3/8	515OG1438
<b>0203234</b>	1/4 x 1/2	515OG1412
<b>0203233</b>	3/8 x 1/2	515OG3812
<b>0203241</b>	3/8 x 3/4	515OG3834
<b>0203235</b>	1/2 x 3/4	515OG1234
<b>0203236</b>	1/2 x 1	515OG1210
<b>0203238</b>	3/4 x 1	515OG3410
<b>0203237</b>	1/2 x 5/4	515OG12114
<b>0203239</b>	3/4 x 5/4	515OG34114
<b>0203240</b>	1 x 5/4	515OG1114

**REDUKCIJA Ž-Ž**
**MESING**

ŠIFRA VOKEL	VELIČINA ["]	ŠIFRA ARTIKLA
<b>0203220</b>	1/4 x 3/8	510OG1438
<b>0203219</b>	3/8 x 1/2	510OG3812
<b>0203158</b>	1/2 x 3/4	510OG1234
<b>0203209</b>	1/2 x 1	510OG1210
<b>0203210</b>	3/4 x 1	510OG3410
<b>0203221</b>	1/2 x 1 1/4	510OG12114
<b>0203222</b>	3/4 x 1 1/4	510OG34114
<b>0203211</b>	1 x 1 1/4	510OG10114

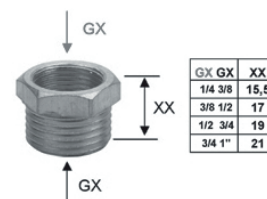
**REDUKCIJA M-Ž**
**MESING**

ŠIFRA VOKEL	VELIČINA ["]	ŠIFRA ARTIKLA
<b>0203199</b>	1/4 x 3/8	511OG1438
<b>0203200</b>	1/4 x 1/2	511OG1412
<b>0203201</b>	3/8 x 1/2	511OG3812
<b>0203202</b>	1/2 x 3/4	511OG1234
<b>0203203</b>	3/8 x 3/4	511OG3834
<b>0203204</b>	1/2 x 1	511OG1210
<b>0203205</b>	3/4 x 1	511OG3410
<b>0203206</b>	1/2 x 1 1/4	511OG12114
<b>0203207</b>	3/4 x 1 1/4	511OG34114
<b>0203208</b>	1 x 1 1/4	511OG10114

## FITINZI

### KOLJENO M-Ž

MESING



GX	B
3/8	39
1/2	43
3/4	50
1	57

ŠIFRA VOKEL	VELIČINA ["]	ŠIFRA ARTIKLA
<b>0203179</b>	3/8	451OG38
<b>0203180</b>	1/2	451OG12
<b>0203181</b>	3/4	451OG34
<b>0203182</b>	1	451OG10
<b>0203183</b>	5/4	451OG114

### KOLJENO Ž-Ž

MESING



GX	B
3/8	32
1/2	37
3/4	44,5
1	50

ŠIFRA VOKEL	VELIČINA ["]	ŠIFRA ARTIKLA
<b>0203184</b>	3/8	452OG38
<b>0203185</b>	1/2	452OG12
<b>0203186</b>	3/4	452OG34
<b>0203187</b>	1	452OG10
<b>0203188</b>	5/4	452OG114

### T-KOMAD

MESING

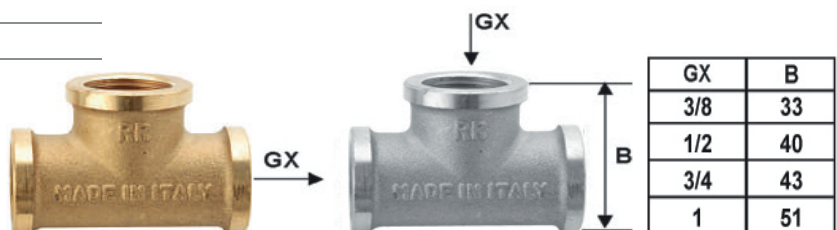

GX	B
3/8	33
1/2	40
3/4	43
1	51

ŠIFRA VOKEL	VELIČINA ["]	ŠIFRA ARTIKLA
<b>0203189</b>	3/8	453OG38
<b>0203190</b>	1/2	453OG12
<b>0203191</b>	3/4	453OG34
<b>0203192</b>	1	453OG10
<b>0203193</b>	5/4	453OG114

### MUFNA

MESING



GX
3/8
1/2
3/4
1

ŠIFRA VOKEL	VELIČINA ["]	ŠIFRA ARTIKLA
<b>0203194</b>	3/8	454OG38
<b>0203195</b>	1/2	454OG12
<b>0203196</b>	3/4	454OG34
<b>0203197</b>	1	454OG10
<b>0203198</b>	5/4	454OG114

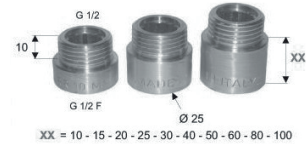
**PRODUŽETAK**
**MESING**

ŠIFRA VOKEL	VELIČINA	ŠIFRA ARTIKLA
<b>0203175</b>	1" x 15 mm	502OG1015
<b>0203176</b>	1" x 20 mm	502OG1020

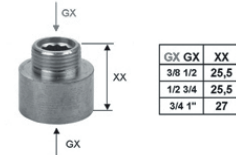
**PRODUŽETAK-REDUKCIJA**
**MESING**

ŠIFRA VOKEL	VELIČINA ["]	ŠIFRA ARTIKLA
<b>0203224</b>	1/4 x 3/8	506OG1438
<b>0203212</b>	1/4 x 1/2	506OG1412
<b>0203213</b>	3/8 x 1/2	506OG3812
<b>0203214</b>	3/8 x 3/4	506OG3834
<b>0203215</b>	1/2 x 3/4	506OG1234
<b>0203216</b>	1/2 x 1	506OG1210
<b>0203217</b>	3/4 x 1	506OG3410
<b>0203225</b>	5/4 x 1/2	506OG12114
<b>0203223</b>	3/4 x 5/4	506OG34114
<b>0203218</b>	1 x 5/4	506OG10114

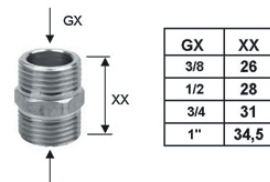
**NIPLO**
**MESING**

ŠIFRA VOKEL	VELIČINA ["]	ŠIFRA ARTIKLA
<b>0203226</b>	3/8	520OG38
<b>0203227</b>	1/2	520OG12
<b>0203228</b>	3/4	520OG34
<b>0203229</b>	1	520OG10
<b>0203230</b>	5/4	520OG54

**SPOJNICA S ČEPOM**
**MESING**

ŠIFRA VOKEL	VELIČINA ["]	ŠIFRA ARTIKLA
<b>0203177</b>	1/2	47112
<b>0203178</b>	3/4	47134

## SPOJNICA

VANJSKI NAVOJ

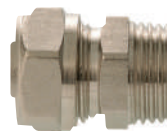

ŠIFRA VOKEL	VELIČINA	ŠIFRA ARTIKLA
<b>0203159</b>	1/2" x 16 mm	495RM1216
<b>0203244</b>	1/2" x 20 mm	495RM1220
<b>0203246</b>	3/4" x 20 mm	495RM3420

## SPOJNICA

UNUTARNJI NAVOJ



ŠIFRA VOKEL	VELIČINA	ŠIFRA ARTIKLA
<b>0203173</b>	1/2" x 16 mm	495RF1216
<b>0203249</b>	1/2" x 20 mm	495RF1220

## SPOJNICA



ŠIFRA VOKEL	VELIČINA [mm]	ŠIFRA ARTIKLA
<b>0203160</b>	16 x 16	495RD1616
<b>0203255</b>	16 x 20	495RD1620
<b>0203256</b>	20 x 20	495RD2020





## KALIBRATOR

Ø 16, 20, 26, 32

ŠIFRA VOKEL	Ø[mm]	ŠIFRA ARTIKLA
<b>0203242</b>	16, 20, 26, 32	495SB



## KLIJEŠTA

ŠIFRA VOKEL	ŠIFRA ARTIKLA
<b>0203243</b>	495 CE

## SET

HIGIJENSKI KOMPLET SA SIGURNOSNIM ZATVARANJEM SA TUŠ RUČICOM I CRIJEVOM ZA HLADNU VODU

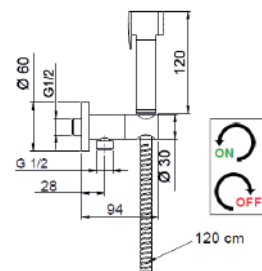

ŠIFRA VOKEL	Ø[mm]	ŠIFRA ARTIKLA
<b>0203264</b>		338 M 332 OW

## SET

HIGIJENSKI KOMPLET TOPLA/HLADNA VODA SA SIGURNOSNIM ZATVARANJEM (CRIJEVO + RUČICA)

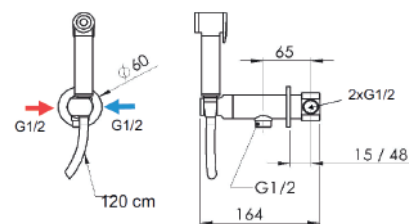

ŠIFRA VOKEL	Ø[mm]	ŠIFRA ARTIKLA
<b>0203265</b>	60	N64W

## M100i Višezlazni vodomjer



Š.Vokel	Opis
0135024	VODOMJER IKOM M100i 1/2" DN 15 BEZ SPOJNICA INDUKTIVNI - PRIPREMLJEN ZA DALJINSKO OČITAVANJE
0135025	VODOMJER IKOM M100i 3/4" DN 20 BEZ SPOJNICA INDUKTIVNI - PRIPREMLJEN ZA DALJINSKO OČITAVANJE
0135026	VODOMJER IKOM M100i 1" DN 25 BEZ SPOJNICA INDUKTIVNI - PRIPREMLJEN ZA DALJINSKO OČITAVANJE
0135027	VODOMJER IKOM M100i 5/4" DN 32 BEZ SPOJNICA INDUKTIVNI - PRIPREMLJEN ZA DALJINSKO OČITAVANJE
0135028	VODOMJER IKOM M100i 6/4" DN 40 BEZ SPOJNICA INDUKTIVNI - PRIPREMLJEN ZA DALJINSKO OČITAVANJE
0135029	VODOMJER IKOM M100i 2" DN 50 BEZ SPOJNICA INDUKTIVNI - PRIPREMLJEN ZA DALJINSKO OČITAVANJE

### Osnovna svojstva:

- Višezlazni mokri vodomjer DN15-DN50 s navojnim spojem i horizontalnim kućištem
- Klasa točnosti C (R=160) u horizontalnom položaju i B (R=80) u vertikalnom položaju
- Induktivna kazaljka
- Vodomjer za hladnu vodu do 50°C
- Vodomjer može biti potopljen: IP68 zaštita
- Opcija: Vodomjer s vertikalnim kućištem koji ima klasu točnosti C (R=160)
- Dodatne opcije: Nepovratni ventil i sito

Mogućnost nadogradnje pulsno izlaza i radio modula:

- Kompatibilan s impulsnim izlazom: FALCON MJ
- Kompatibilan s radio modulom : MERLIN MJ 868

## Elster H-4000 Woltmann turbinski vodomjer



Š.Vokel	Opis
0135030	VODOMJER INDUSTRIJSKI ELSTER H4000 DN 50 PRIPREMLJEN ZA DALJINSKO OČITAVANJE
0135031	VODOMJER INDUSTRIJSKI ELSTER H4000 DN 65 PRIPREMLJEN ZA DALJINSKO OČITAVANJE
0135032	VODOMJER INDUSTRIJSKI ELSTER H4000 DN 80 PRIPREMLJEN ZA DALJINSKO OČITAVANJE
0135033	VODOMJER INDUSTRIJSKI ELSTER H4000 DN 100 PRIPREMLJEN ZA DALJINSKO OČITAVANJE

### Osnovna svojstva:

- Woltmann turbinski vodomjer DN40-DN300
- Izmjenjiv mjerni uložak na licu mjesta, bez potrebe za skidanje kućišta
- Mogućnost ugradnje u svim položajima bez gubitaka deklarirane klase točnosti
- Vodomjer može biti potopljen: IP68 zaštita

Mogućnost nadogradnje pulsno izlaza i radio modula:

- Kompatibilan s impulsnim izlazom: Pr7
- Kompatibilan s radio modulom : MERLIN 868

## ITAP - Spojnice za vodomjere



Š.Vokel	Opis
0150033	SPOJNICA ZA VODOMJER 3/4"x 1/2" ART.154
0150034	SPOJNICA ZA VODOMJER 1"x 3/4" ART.154
0150035	SPOJNICA ZA VODOMJER 1 1/4"x 1" ART.154
0150036	SPOJNICA ZA VODOMJER 1 1/2"x 1 1/4" ART.154
0150037	SPOJNICA ZA VODOMJER 2"x 1 1/2" ART.154
0150038	SPOJNICA ZA VODOMJER 2 1/2"x 2" ART.154

## V200H Volumetrijski hibridni vodomjer DN15-DN40



Š.Vokel	Opis
0135034	ELEKTRONIČKI VODOMJER IKOM V200H 3/4" DN 20, SA INTEGRIRANIM RADIJSKIM MODULOM ZA DALJINSKO OČITANJE

### Osnovna svojstva:

- Volumetrijski klipni vodomjer s elektroničkim brojiлом i integriranim radijskim modulom
- Dimenzije DN 15 i DN 20 su dostupne i u izvedbi s polimernim tijelom i navojem od mesinga
- Klasa zaštite IP 68
- Viskoka točnost ( do R400 za DN15 i Dn20)
- Frekvencija 868 Mhz
- Radna temperatura: -10°C do +55°C
- Integrirani radio modul s protokolom WMBus po OMS standardu, te s AES enkripcijom podataka
- Slanje podataka vrši se svakih 10 sekundi (podesivo)
- Snaga odašiljanja: 25 mW
- Alarmi: povratni protok, curenje, pucanje cijevi, slaba baterija, nema protoka
- Životni vijek baterije 15 godina

# AKUMULACIJSKI SPREMNICI / BOJLERI

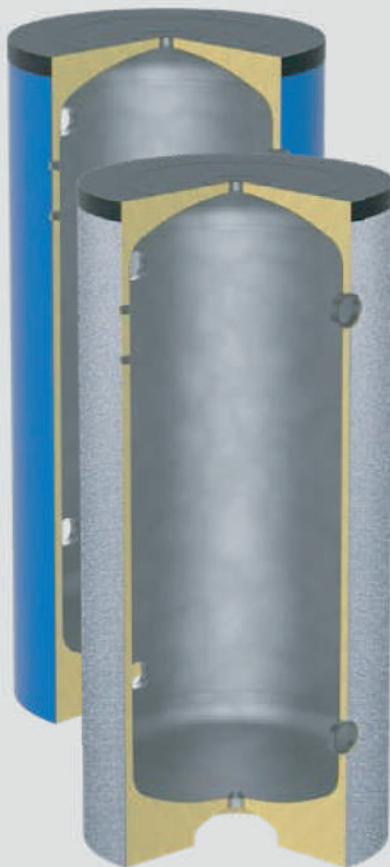
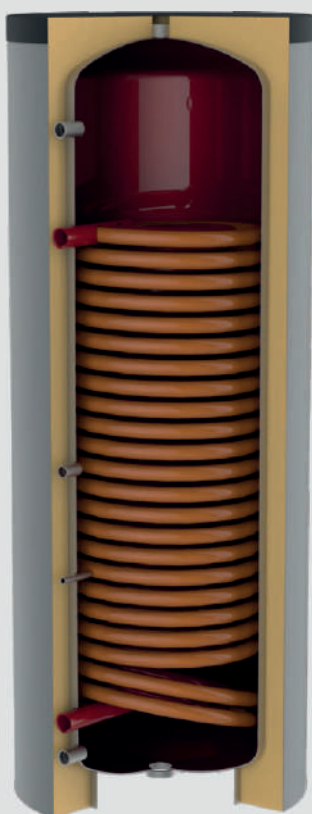

# fiorini

# AKUMULACIJSKI SPREMNICI MINI-HC (Puffer)

MINI-HC serija uključuje spremnike za postrojenja GRIJANJA i HLAĐENJA - MONTAŽA SAMO NA ZID

**Materijal:** ugljični čelik

**Vanjska obloga:** obojeni pocinčani metalni lim, bijela boja

## Izolacija

Kapacitet (l)	Tip
40, 80	Kruta poliuretanska pjena visoke gustoće

## Radna ograničenja

Min. temperatura	Max. temperatura	Max. tlak
-10 °C	90 °C	6 bar

Kapacitet l	MINI montaža na zid		Energetski razred	Dimenzije cm	Težina kg
	Artikal	Šifra Vokel			
40	817010175X	<b>1457015</b>	<b>B</b>	50x50x50	25
80	817010176X	<b>1457001</b>	<b>B</b>	50x50x100	35



TESTED

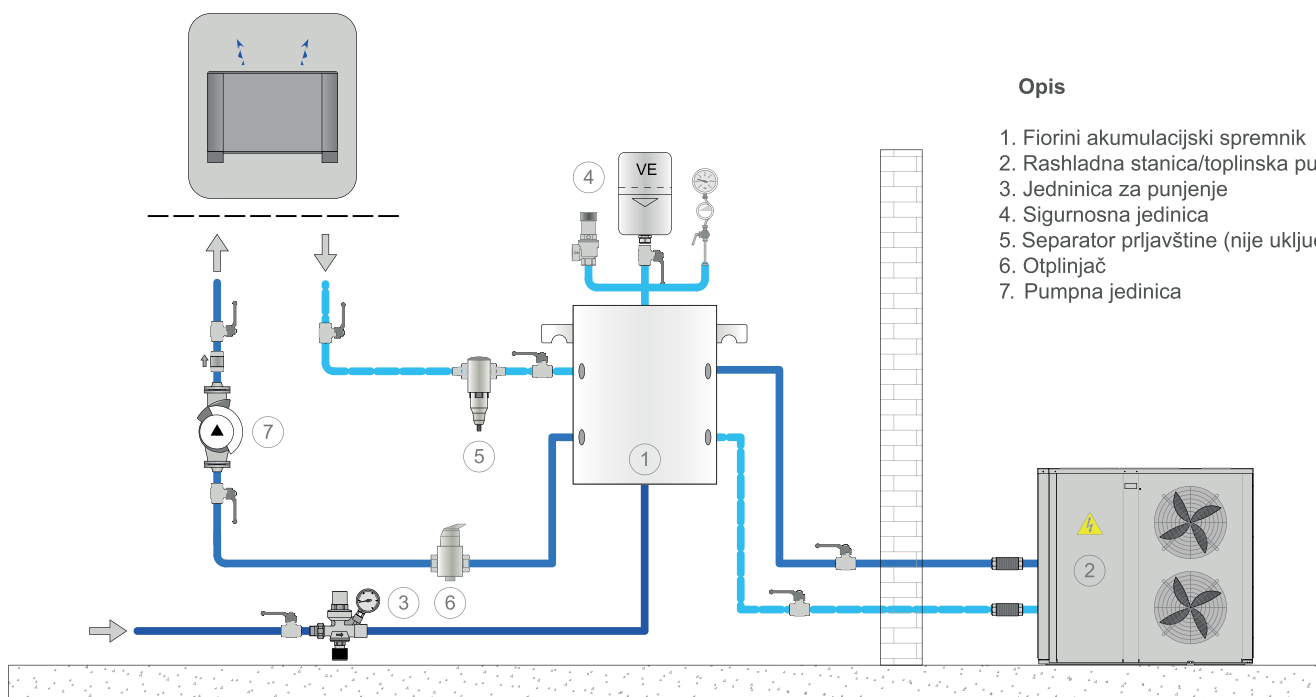

## Opis

1. Fiorini akumulacijski spremnik
2. Rashladna stanica/toplinska pumpa
3. Jedinica za punjenje
4. Sigurnosna jedinica
5. Separator prljavštine (nije uključen)
6. Otplinjač
7. Pumpna jedinica



cap. = 40

cap. = 80

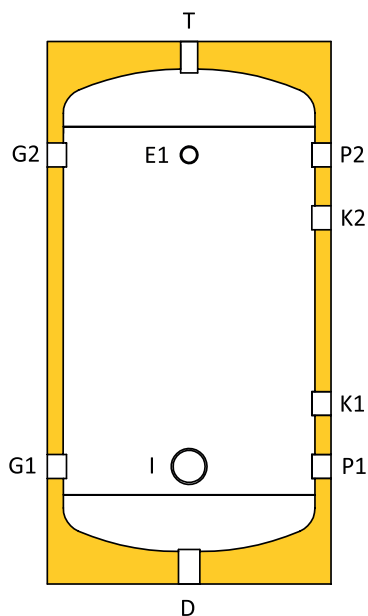
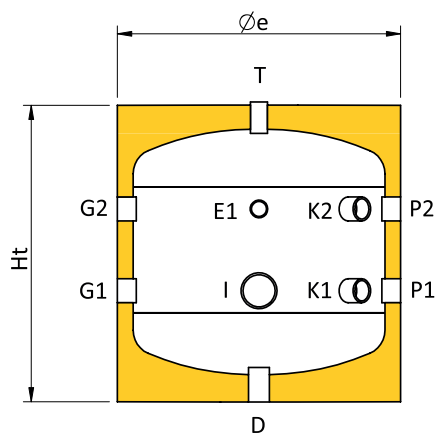

### Opis

D	Pražnjenje
E1	Kapilarna cijev za osjetnike
G1	od postrojenja
G2	do postrojenja
I	Električni grijač
K1	prema izvoru energije
K2	od izvora energije
P1	prema izvoru energije
P2	od izvora energije
T	otvor

### Spojnice

Kapacitet l	D inch	E inch	G1 inch	G2 inch	I inch	K1 inch	K2 inch	P1 inch	P2 inch	T inch
40	3/4"	1/2"	1"	1"	1 1/2"	1"	1"	1"	1"	1/2"
80	3/4"	1/2"	1"	1"	1 1/2"	1"	1"	1"	1"	1/2"

### Dimenzije

Kapacitet l	Øe mm	Ht mm	R* mm	E mm	G1 mm	G2 mm	I mm	K1 mm	K2 mm	P1 mm	P2 mm
40	460	477	663	307	177	307	177	177	307	177	307
80	460	862	978	682	187	682	187	287	582	187	682

R\*: Povratna kvota

# VKG akumulacijski spremnici (Puffer)

VKG serija uključuje akumulacijske spremnike za hladnu i toplu vodu od -10°C do 60°C

Materijal: ugljični čelik

## Vanjska obloga

Model	Tip	Korištenje
VKG	obojeni PVC	unutra
VKGE	reljefni aluminijski lim	vani

1  
2

## Izolacija

Kapacitet (l)	Tip	Debljina. (mm)
od 100 do 1000	Kruta poliuretanska pjena visoke gustoće	30
od 1500 + horizontalna verzija	Poliuretanska pjena zatvorene ćelije	20

## Radna ograničenja

Min temperatura	Max temperatura	Max tlak
-10 °C	60 °C	6 bar



Kapacitet l	VKG vertikalni, PVC obojeni		VKGE vertikalni, reljefni aluminijski lim		Vertikalno pakiranje		VKG horizontalni, PVC obojeni	
	Artikal	Šifra Vokel	Artikal	Šifra Vokel	Dimenzije cm	Težina kg	Artikal	Šifra Vokel
100	816010130	<b>1457002</b>	816011275H8X		49x49x107	24	816010142	
200	816010131	<b>1457003</b>	816011276H8X		54x54x145,5	36	816010143	
300	816010132	<b>1457005</b>	816011277H8X		64x64x154,5	46	816010144	
500	816010133	<b>1457004</b>	816011278H8X		74x74x183,5	78	816010145	
800	816010134	<b>1457013</b>	816011279H8X		88x88x186	105	816010146	
1000	816010135	<b>1457014</b>	816011280H8X		94x94x214,6	129	816010147	
1500	816010136				107x107x228	182	816010148	
2000	816010137				117x117x260	250	816010149	
2500	816010138				132x132x239,5	267	816010150	
3000	816010139				132x132x289,5	314	816010151	
4000	816010140				147x147x296,5	470	816010152	
5000	816010141				167x167x300,5	557	816010153	
6000	816011186X				282x203x204	647		
8000	816011187X				352x203x204	782		
10000	816011188X				427x203x204	927		

# VKG akumulacijski spremnici (Puffer)

1500 ≤ cap. ≤ 5.000

6000 ≤ cap. ≤ 10.000

Opis

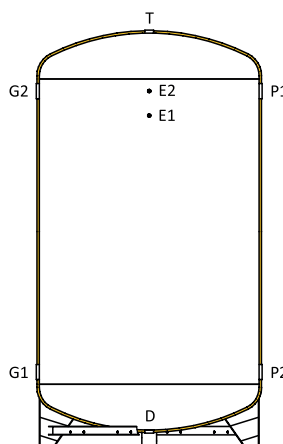
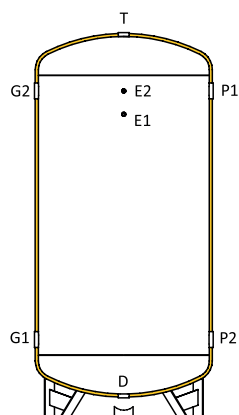
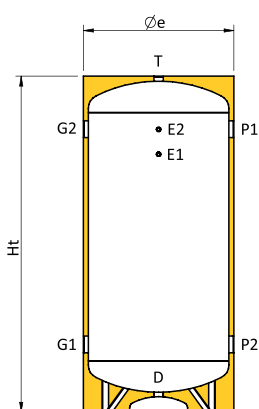

- D Pražnjenje
- E1 Kapilarna cijev za osjetnike
- E2 Kapilarna cijev za osjetnike
- G1 od postrojenja
- G2 do postrojenja
- P1 prema izvoru energije
- P2 od izvora energije
- T Otvor

## Dimenzije i sponice za vertikalnu verziju

Kap. l	Øe mm	Ht mm	R* mm	D mm	E1 mm	E2 mm	G1 mm	G2 mm	P1 mm	P2 mm	D inch	E1 inch	E2 inch	G1 inch	G2 inch	P1 inch	P2 inch	T inch
100	460	950	1060	125	610	760	290	760	290	290	1"1/4	1/2"	1/2"	1"1/2	1"1/2	1"1/2	1"1/2	1"1/4
200	510	1335	1430	120	990	1140	290	1140	290	290	1"1/4	1/2"	1/2"	1"1/2	1"1/2	1"1/2	1"1/2	1"1/4
300	610	1425	1550	130	1015	1165	365	1165	365	365	1"1/4	1/2"	1/2"	2"	2"	2"	2"	1"1/4
500	710	1710	1855	135	1285	1435	385	1435	385	385	1"1/4	1/2"	1/2"	3"	3"	3"	3"	1"1/4
800	850	1740	1940	125	1295	1445	395	1445	395	395	1"1/2	1/2"	1/2"	3"	3"	3"	3"	1"1/2
1000	910	2025	2220	120	1560	1710	410	1710	410	410	1"1/2	1/2"	1/2"	3"	3"	3"	3"	1"1/2
1500	1040	2160	2400	165	1650	1800	500	1800	500	500	2"	1/2"	1/2"	3"	3"	3"	3"	2"
2000	1140	2480	2730	155	1955	2105	505	2105	505	505	2"	1/2"	1/2"	3"	3"	3"	3"	2"
2500	1290	2275	2620	180	1715	1865	565	1865	565	565	2"	1/2"	1/2"	4"	4"	4"	4"	2"
3000	1290	2775	3060	180	2215	2365	565	2365	565	565	2"	1/2"	1/2"	4"	4"	4"	4"	2"
4000	1440	2845	3190	160	2240	2390	590	2390	590	590	2"	1/2"	1/2"	4"	4"	4"	4"	2"
5000	1640	2885	3320	140	2250	2400	600	2400	600	600	2"	1/2"	1/2"	4"	4"	4"	4"	2"
6000	1840	2715	3280	140	2015	2215	615	2215	615	615	2"	1/2"	1/2"	4"	4"	4"	4"	2"
8000	1840	3415	3880	140	2715	2915	615	2915	615	615	2"	1/2"	1/2"	4"	4"	4"	4"	2"
10000	1840	4165	4555	140	3465	3665	615	3665	615	615	2"	1/2"	1/2"	4"	4"	4"	4"	2"

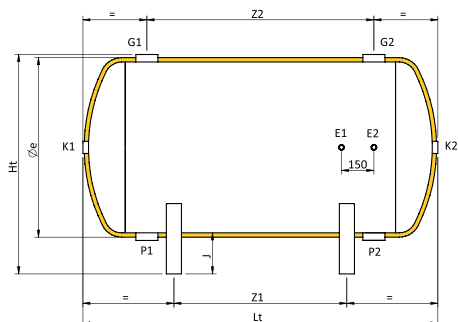

Opis

- E1 Kapilarna cijev za osjetnike
- E2 Kapilarna cijev za osjetnike
- G1 od postrojenja
- G2 do postrojenja
- K1 otvor
- K2 otvor
- P1 prema izvoru energije
- P2 od izvora energije

## Dimenzije i spojnice za horizontalnu verziju

Kap. l	Øe mm	Lt mm	Ht mm	J mm	Z1 mm	Z2 mm	E1 inch	E2 inch	G1 inch	G2 inch	K1 inch	K2 inch	P1 inch	P2 inch
100	440	850	545	120	310	470	1/2"	1/2"	1"1/2	1"1/2	1"1/4	1"1/4	1"1/2	1"1/2
200	490	1240	595	120	700	850	1/2"	1/2"	1"1/2	1"1/2	1"1/4	1"1/4	1"1/2	1"1/2
300	590	1320	715	140	600	800	1/2"	1/2"	2"	2"	1"1/4	1"1/4	2"	2"
500	690	1600	865	190	900	1050	1/2"	1/2"	3"	3"	1"1/4	1"1/4	3"	3"
800	830	1640	1005	190	900	1050	1/2"	1/2"	3"	3"	1"1/2	1"1/2	3"	3"
1000	890	1930	1065	190	1130	1300	1/2"	1/2"	3"	3"	1"1/2	1"1/2	3"	3"
1500	1040	2020	1215	190	950	1300	1/2"	1/2"	3"	3"	2"	2"	3"	3"
2000	1140	2350	1325	200	1320	1600	1/2"	1/2"	3"	3"	2"	2"	3"	3"
2500	1290	2120	1500	225	1020	1300	1/2"	1/2"	4"	4"	2"	2"	4"	4"
3000	1290	2620	1500	225	1390	1800	1/2"	1/2"	4"	4"	2"	2"	4"	4"
4000	1440	2710	1650	225	1380	1800	1/2"	1/2"	4"	4"	2"	2"	4"	4"
5000	1640	2770	1850	225	1380	1800	1/2"	1/2"	4"	4"	2"	2"	4"	4"

R\*: Povratna kvota

# Bojleri za toplinske pumpe – SMART HP

Paleta HP proizvoda sastoji se od bojlera za proizvodnju tople vode za kućanstva s dvostrukim spiralnim izmjenjivačem s velikom površinom za spajanje sa toplinskom pumpom. Bojleri su dostupni u nekoliko kapaciteta, od 300 do 1000 l i izolirani su krutim poliuretanom visoke gustoće, izvana prekriven PVC-om i zaštićen s magnezijevom anodom radi zaštite od galvanskih struja i inspeksijskom prirubnicom za lak pristup tijekom faze održavanja.

Materijal: S 235 JR ugljični čelik

### Tretman za unutrašnju zaštitu:

Emajliran proizvod prema normi DIN 4753.3

### Izolacija

Kapacitet (l)	Tip
od 300 do 1000	Kruta poliuretanska pjena visoke gustoće

### Radna ograničenja

Skladištenje		Primarni krug	
max. temperatura	max. tlak	max. temperatura	max. tlak
95°C	10 bar	110°C	12 bar



Podesive nogare, sigurnosni ventil i termometar, magnezijeva zaštitna anoda

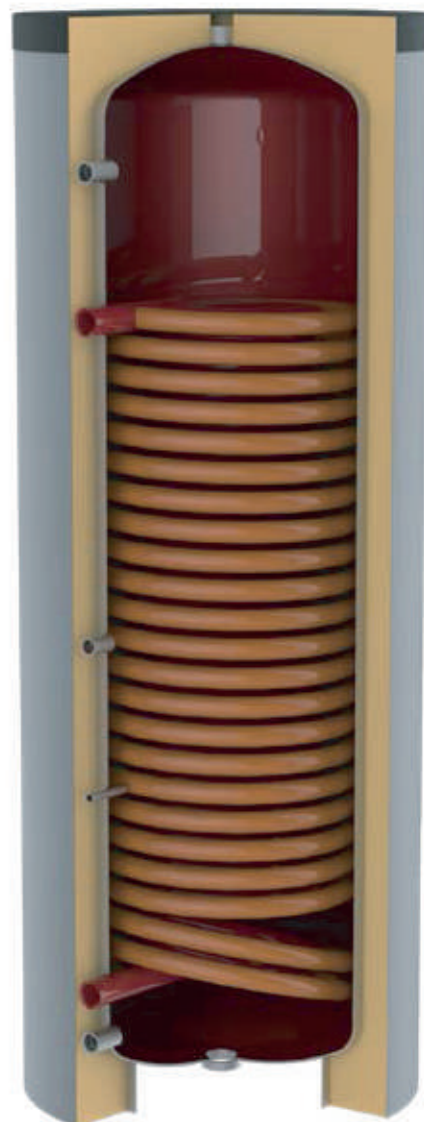

TESTED

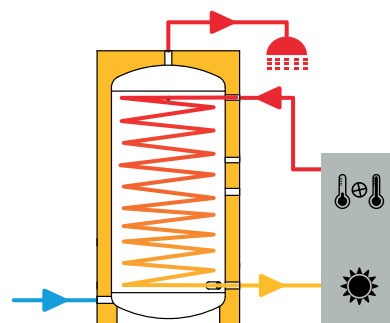

Kapacitet l	Artikal	Šifra Vokel	Energetski razred	Vertikalno pakiranje	
				Dimenzije cm	Težina kg
300	819060121X	<b>1457006</b>	<b>B</b>	75x75x168	177
500	819060123X	<b>1457007</b>	<b>C</b>	75x75x204	239
750	819060124X		<b>C</b>	90x90x207	318
1000	819060125X		<b>C</b>	110x110x198	409

# Bojleri za toplinske pumpe – SMART HP

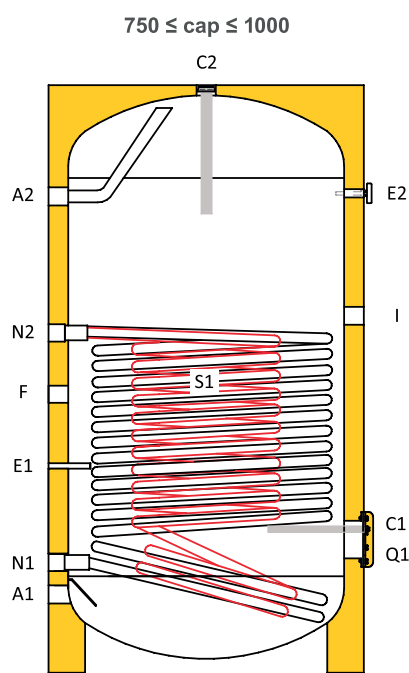
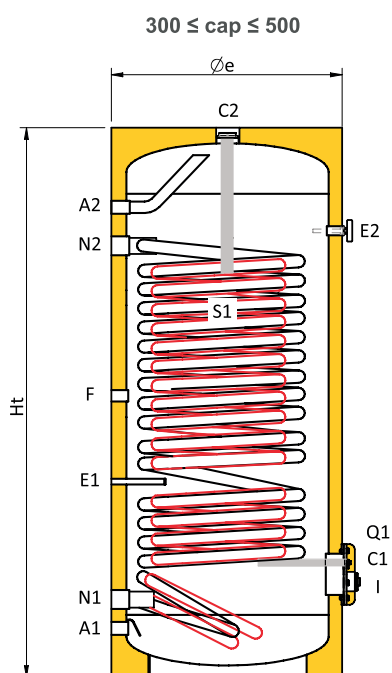

## Opis

<b>A1</b>	ulaz tople vode
<b>A2</b>	izlaz tople vode
<b>C1</b>	Anoda
<b>C2</b>	Anoda
<b>E1</b>	Kapilarna cijev za osjetnike
<b>E2</b>	Kapilarna cijev za osjetnike
<b>F</b>	Recirkulacija
<b>I</b>	Električni grijač
<b>N1</b>	Donji solarni izlaz izmj.
<b>N2</b>	Donji solarni ulaz izmj.
<b>Q1</b>	Inspeksijska prirubnica
<b>S1</b>	Donji izmjenjivač

## Spojnice

Kap. l	A1 inch	A2 inch	C1 mm	C2 inch	E1 inch	E2 mm	F inch	I inch	N1 inch	N2 inch	Q1 (Øext/Øint) mm
300	1"	1"	M8	1 1/4	3/8"x90	1/2"	3/4"	1 1/2	1 1/4	1 1/4	Ø180/Ø120
500	1"	1"	M8	1 1/4	3/8"x120	1/2"	3/4"	1 1/2	1 1/4	1 1/4	Ø180/Ø120
750	1 1/2	1 1/2	M8	2"	3/8"x140	1/2"	1 1/4	1 1/2	1 1/4	1 1/4	Ø280/Ø205
1000	1 1/2	1 1/2	M8	2"	3/8"x160	1/2"	1 1/4	1 1/2	1 1/4	1 1/4	Ø280/Ø205

## Dimenzije

Kap. l	Øe mm	Ht mm	R* mm	A1 mm	A2 mm	E1 mm	E2 mm	F mm	I mm	N1 mm	N2 mm	Q1** mm
300	670	1615	1750	130	1355	550	1295	765	-	220	1035	290
500	750	1950	2090	180	1650	610	1580	870	-	265	1415	340
750	855	2050	2225	215	1715	755	1725	1175	1425	395	1355	445
1000	1055	1960	2230	247	1567	747	1577	1077	1277	447	1197	497

R\*: Povratna kvota Q1\*\*: Visina od inspeksijske prirubnice do poda



## Bojleri za toplinske pumpe – SMART HP

Kapacitet l	Ti °C	Proizvodnja tople vode TiDHW = 10°C			Izmjenjivač	
		TuDHW= 45°C		Ta = 50°C TuDHW = 45°C	Površina m <sup>2</sup>	Protok mk/h
		l/h (a)	kW (b)	l/10 min. (e)		
300	50	688	28	433	3,8	4,0
	80	2236	91	691		
500	50	958	39	691	6	4,0
	80	2432	99	937		
750	50	982	40	961	6,5	4,0
	80	3390	138	1362		
1000	50	982	40	1227	6,5	4,0
	80	3390	138	1628		

- kontinuirani protok vode sa TuACS=45°C
- snaga izmjenjivača s TuACS=45°C
- vrijednost tople vode na 45°C u prvih 10 min sa skladišnom temperaturom od 50°C
- kapacitet izmjenjivača : 7.10 Lt/mq

### Opis

- 1 Spremnik tople vode
- 2 Magnzijska anoda
- 3 toplinska pumpa / dodatni izvor
- 4 temp.sonde tople vode
- 5 bakteriostatski filter hladne vode
- 6 Recirkulacijska pumpa
- 7 Termostatski mješač tople vode
- 8 Sigurnosna grupa
- 9 Električni grijač (opcija)

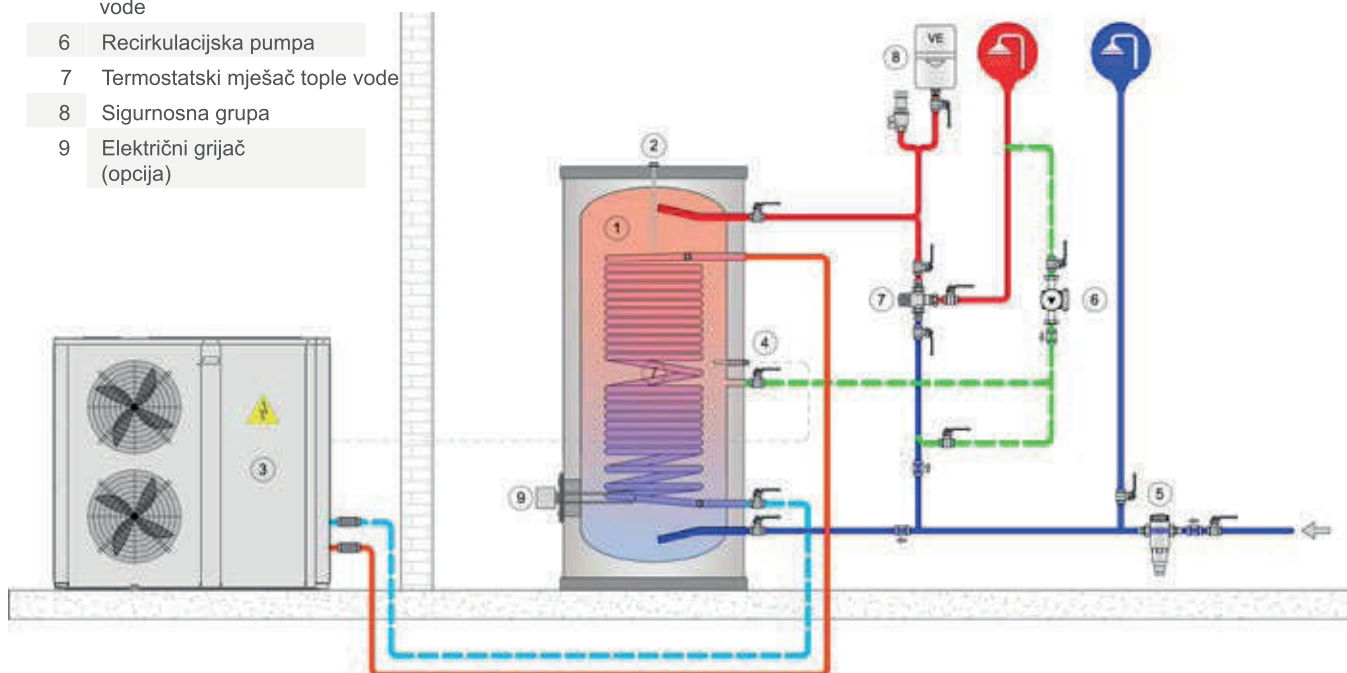

# Bojleri za toplinske pumpe – SMART HP

## Gubitak tlaka fiksnog izmjenjivača topline

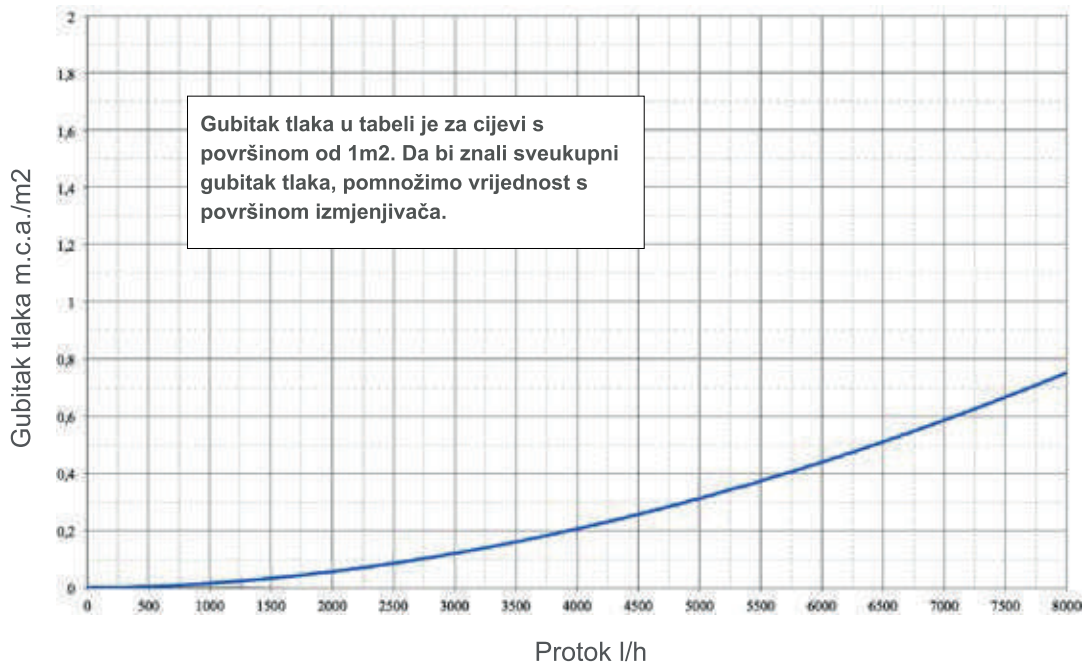

# SMART 2 Bojleri

Paleta proizvoda Smart 2 sastoji se od bojlera za proizvodnju tople vode za domaćinstva s dvostrukim fiksnim izmjenjivačem topline, dostupan u nekoliko kapaciteta (od 200 do 3000 litara). Opremljeni su različitim vrstama izolacije (vidi tablicu dolje), vanjskog PVC premaza, magnezij anode za zaštitu od galvanskih struja, ispitne priрубnice za lak pristup tijekom faze kontrole i održavanja.

Materijal: S 235 JR ugljični čelik

Treatment za unutarnju zaštitu: Bojler s kapacitetom do 1000 l su emajlirani proizvodi u skladu s DIN4573.3, oni s kapacitetom od 1500 do 3000 l su tretirani s Bluetech tehnikom.

## Izolacija

Kapacitet (l)	Tip
od 200 do 1000	Kruta poliuretanska pjena visoke gustoće
od 1500	Poliester vlakna

## Radna ograničenja

Kapacitet (l)	Skladištenje		Primarni krug	
	temp. max.	tlak max.	temp. max.	tlak max.
up to 1000	95°C	10 bar	110°C	12 bar
from 1500 to 3000	80°C	6 bar	110°C	12 bar



Podesive noge po visini za veličine do 500 l, sigurnosni ventil i termometar za veličine do 1000 l, magnezijum zaštitna anoda za sve veličine.

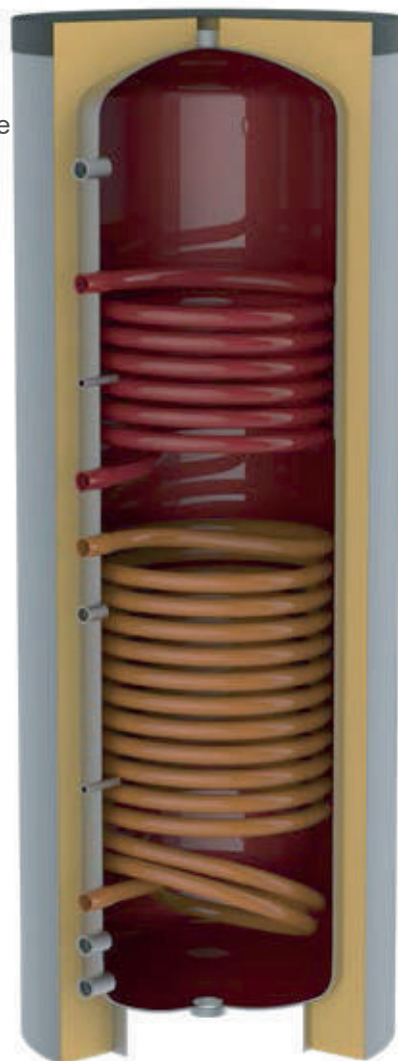

TESTED

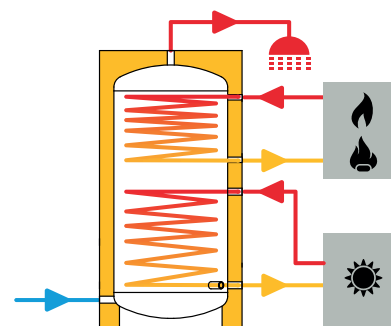

Kapacitet l	Artikal	Šifra Vokel	Energetski razred	Vertikalno pakiranje	
				Dimenzije cm	Težina kg
200	819060114X	<b>1457008</b>	<b>B</b>	75x75x120	98
300	819060115X	<b>1457009</b>	<b>B</b>	75x75x168	133
500	819060117X	<b>1457010</b>	<b>C</b>	75x75x204	215
750	819060118X	<b>1457011</b>	<b>C</b>	90x90x207	296
1000	819060119X	<b>1457012</b>	<b>C</b>	110x110x198	360
1500	819080003X		<b>C</b>	123x123x237,5	281
2000	819080004X		<b>C</b>	132x132x269,5	366
3000	819080006X			147x147x299	454

# SMART 2 Bojleri

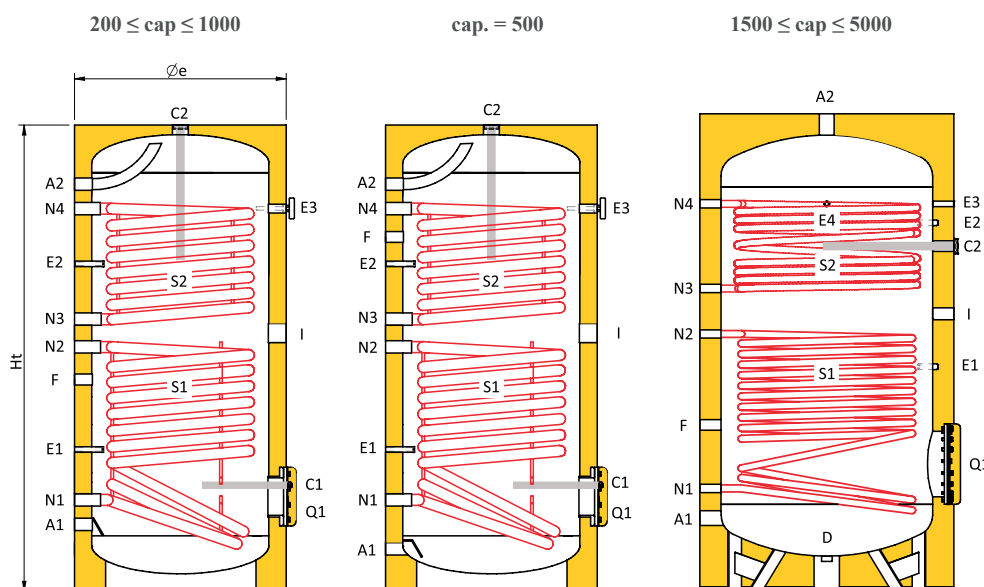

## Opis

- A1 Ulaz tople vode
- A2 Izlaz tople vode
- C1 Anoda
- C2 Anoda
- D Pražnjenje
- E1 Kapilarna cijev za osjetnike
- E2 Kapilarna cijev za osjetnike
- E3 Kapilarna cijev za osjetnike
- E4 Kapilarna cijev za osjetnike
- F Recirkulacija
- I Električni grijač
- N1 Donji solarni izlaz izmjenjivača
- N2 Donji solarni ulaz izmjenjivača
- N3 Gornji kotlovski izlaz izmjenjivača
- N4 Gornji kotlovski ulaz izmjenjivača
- Q1 Inspeksijska priрубnica
- S1 Donji izmjenjivač
- S2 Gornji izmjenjivač

## Spojnica

Kap. l	A1 inch	A2 inch	C1 inch	C2 inch	D inch	E1 inch	E2 inch	E3 inch	E4 inch	F inch	I inch	N1 inch	N2 inch	N3 inch	N4 inch	Q1 (Øext/Øint) mm
200	1'	1'	M8	1 1/4	-	3/8"x90	3/8"x90	1/2"	-	3/4"	1 1/2	1'	1'	1'	1'	Ø180/120
300	1'	1'	M8	1 1/4	-	3/8"x90	3/8"x90	1/2"	-	3/4"	1 1/2	1'	1'	1'	1'	Ø180/Ø120
500	1'	1'	M8	1 1/4	-	3/8"x125	3/8"x125	1/2"	-	3/4"	1 1/2	1'	1'	1'	1'	Ø180/Ø120
750	1 1/2	1 1/2	M8	2"	-	3/8"x140	3/8"x140	1/2"	-	1 1/4	1 1/2	1'	1'	1'	1'	Ø280/Ø205
1000	1 1/2	1 1/2	M8	2"	-	3/8"x160	3/8"x160	1/2"	-	1 1/4	1 1/2	1'	1'	1'	1'	Ø280/Ø205
1500	2'	2'	-	1 1/4	1 1/4	1/2"	1/2"	1/2"	1/2"	1 1/4	1 1/2	1'	1'	1'	1'	Ø380/Ø300
2000	2'	2'	-	1 1/4	1 1/4	1/2"	1/2"	1/2"	1/2"	1 1/4	1 1/2	1'	1'	1'	1'	Ø380/Ø300
3000	3'	3'	-	1 1/4	1 1/4	1/2"	1/2"	1/2"	1/2"	1 1/4	1 1/2	1'	1'	1'	1'	Ø380/Ø300

## Dimenzije

Kap. l	Øe mm	Ht mm	R* mm	A1 mm	A2 mm	D mm	E1 mm	E2 mm	E3 mm	F mm	I mm	N1 mm	N2 mm	N3 mm	N4 mm	Q1 mm
200	670	1130	1290	130	975	-	345	780	825	450	630	210	580	685	895	290
300	670	1615	1750	130	1355	-	435	1030	1295	650	805	280	750	860	1200	290
500	750	1950	2090	180	1650	-	530	1200	1570	1320	1030	320	970	1090	1439	329
750	855	2050	2225	215	1715	-	575	1365	1725	925	1110	375	1045	1175	1555	445
1000	1055	1960	2230	247	1567	-	587	1247	1577	877	1047	447	997	1097	1437	477
1500	1250	2280	2605	345	-	165	1060	1740	1830	785	1310	485	1215	1430	1830	600
2000	1350	2600	2930	345	-	155	1165	2065	2150	815	1495	480	1315	1690	2150	605
3000	1450	2870	3220	400	-	180	1375	2225	2410	875	1625	550	1540	1680	2410	665

R\*: povratna kvota Q1\*\*: Visina od centra inspeksijske priрубnice do poda

# SMART 2 Bojleri

Kapacitet	Ti	Proizvodnja tople vode $\Delta T_{ACS} = 10^{\circ}\text{C}$						Visoka izmjena Površina $\text{m}^2$	Niska izmjena Površina $\text{m}^2$	Nominal protok mk/h
		$T_{uACS} = 45^{\circ}\text{C}$		$T_{uACS} = 60^{\circ}\text{C}$		$T_a = 50^{\circ}\text{C}$	$T_a = 60^{\circ}\text{C}$			
		l/h (a)	kW (b)	l/h (c)	kW (d)	l/10 min. (e)	l/10 min. (f)			
200	70	417	17	206	12	282	324	0,7	1	3
	80	540	22	292	17	302	345			
	90	614	25	361	21	315	357			
300	70	638	26	309	18	425	489	1,1	1,4	3
	80	860	35	481	28	462	526			
	90	1007	41	584	34	486	550			
400	70	638	26	309	18	531	616	1,1	1,8	3
	80	860	35	481	28	568	653			
	90	1007	41	584	34	593	678			
500	70	638	26	309	18	638	744	1,1	2	3
	80	860	35	481	28	675	781			
	90	1007	41	584	34	699	806			
750	70	688	28	344	20	912	1072	1,2	2,4	3
	80	933	38	516	30	953	1112			
	90	1081	44	636	37	978	1137			
1000	70	884	36	430	25	1211	1423	1,5	2,7	3
	80	1179	48	653	38	1260	1473			
	90	1376	56	808	47	1293	1505			
1500	70	1326	54	653	38	1816	2135	2,3	3,7	6,0
	80	1793	73	980	57	1894	2213			
	90	2113	86	1238	72	1947	2267			
2000	70	1744	71	860	50	2418	2843	3	4,3	8,0
	80	2334	95	1290	75	2516	2942			
	90	2727	111	1599	93	2582	3007			
3000	70	2211	90	1083	63	3559	4198	3,8	5,2	8,0
	80	2948	120	1634	95	3682	4321			
	90	3440	140	2029	118	3764	4403			

- a kontinuirani protok tople vode s  $T_{uACS} = 45^{\circ}\text{C}$
- b snaga izmjenjivača s  $T_{uACS} = 45^{\circ}\text{C}$
- c kontinuirani protok tople vode s  $T_{uACS} = 60^{\circ}\text{C}$
- d snaga izmjenjivača s  $T_{uACS} = 60^{\circ}\text{C}$
- e količina tople vode na  $45^{\circ}\text{C}$  u prvih 10 min s temperaturom skladištenja od  $50^{\circ}\text{C}$
- f količina tople vode na  $45^{\circ}\text{C}$  u prvih 10 min s temperaturom skladištenja od  $60^{\circ}\text{C}$
- kapacitet izmjenjivača: 7,10 lt/m<sup>2</sup>



# SMART 2 Bojleri

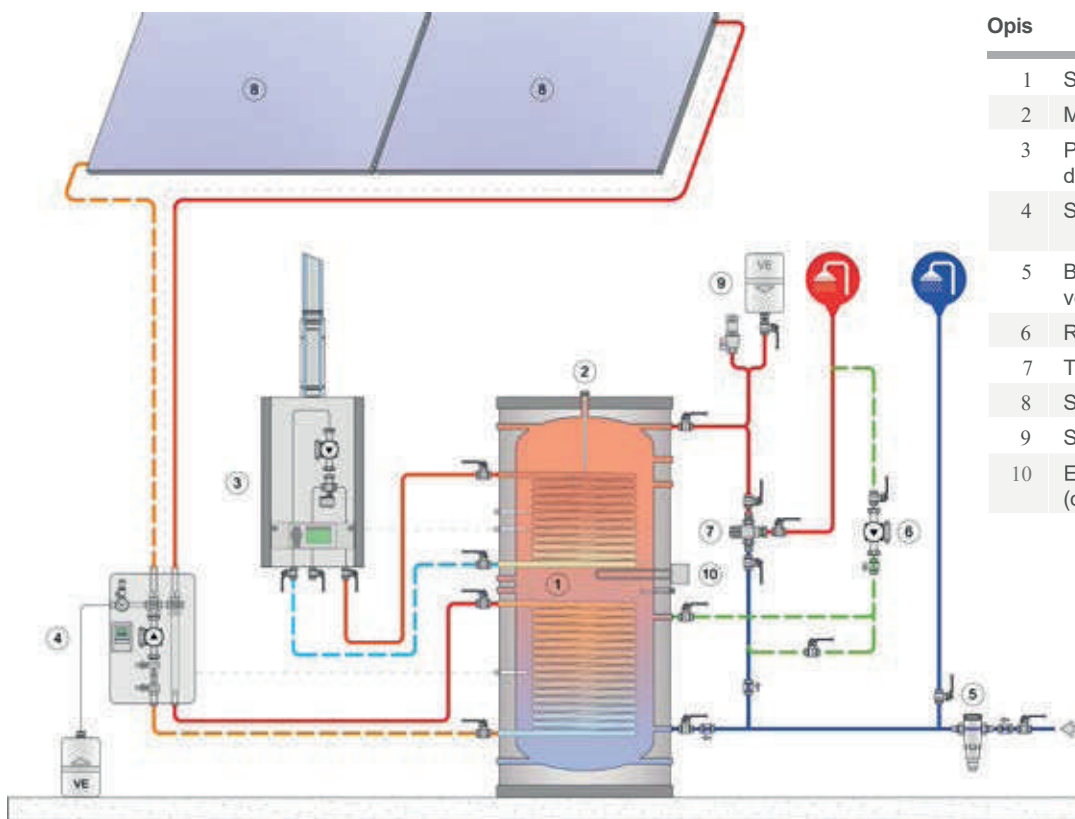

## Opis

- |    |                                     |
|----|-------------------------------------|
| 1  | Spremnik tople vode                 |
| 2  | Magnezijska anoda                   |
| 3  | Plinski grijač vode / dodatni izvor |
| 4  | Solarna grupa                       |
| 5  | Bakterijostatski filter hladne vode |
| 6  | Recirkulacijska pumpa               |
| 7  | Termostatska mješalica tople vode   |
| 8  | Solarni panel                       |
| 9  | Sigurnosna grupa                    |
| 10 | Električni grijač (opcija)          |

## Gubitak tlaka fiksnog izmjenjivača topline

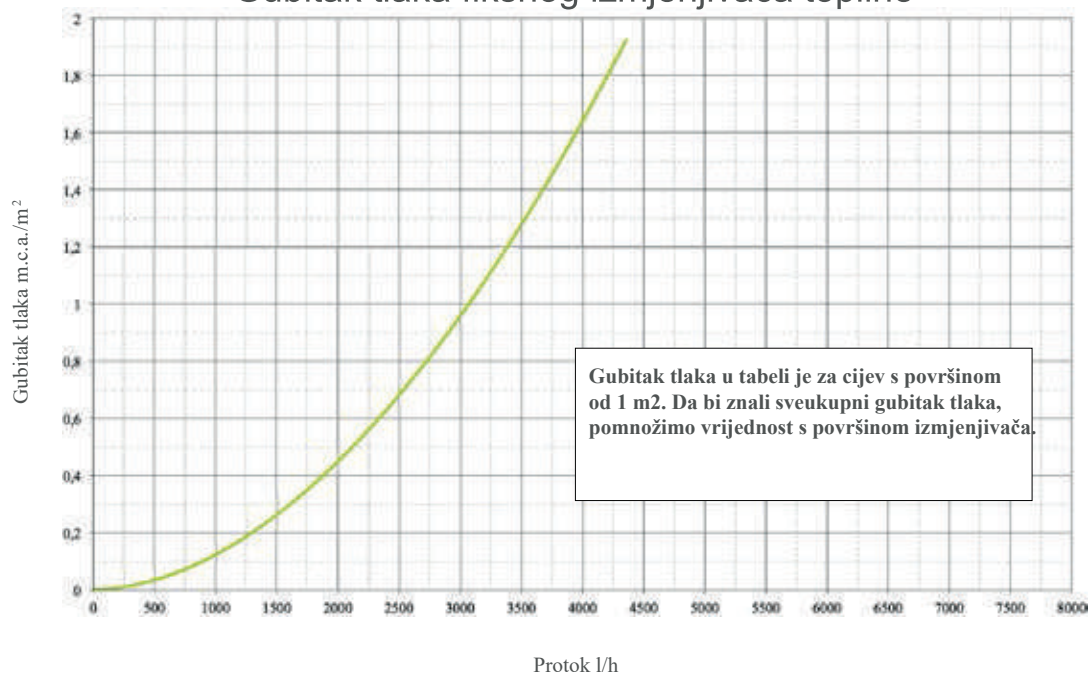

# Katalog proizvoda





NISKOŠUMNE CIJEVI  
ZA KUĆNU KANALIZACIJU SA GUMENOM BRTVOM

VOKEL ŠIFRA	OPIS	DIMENZIJA (Ø) cm	PAKIRANJE (kom)	ARTIKAL
0175001	NISKOŠUMNA CIJEV SILENT	32/25	100	27143
0175002	NISKOŠUMNA CIJEV SILENT	32/50	60	27144
0175003	NISKOŠUMNA CIJEV SILENT	32/100	40	27146
0175004	NISKOŠUMNA CIJEV SILENT	32/200	104	27148
0175005	NISKOŠUMNA CIJEV SILENT	40/25	60	27150
0175006	NISKOŠUMNA CIJEV SILENT	40/50	40	27151
0175007	NISKOŠUMNA CIJEV SILENT	40/100	25	27153
0175008	NISKOŠUMNA CIJEV SILENT	40/200	88	27155
0175009	NISKOŠUMNA CIJEV SILENT	50/25	90	13312
0175010	NISKOŠUMNA CIJEV SILENT	50/50	90	13313
0175011	NISKOŠUMNA CIJEV SILENT	50/100	120	13315
0175012	NISKOŠUMNA CIJEV SILENT	50/200	120	13317
0175013	NISKOŠUMNA CIJEV SILENT	50/300	80	13318
0175014	NISKOŠUMNA CIJEV SILENT	50/400	80	13319
0175015	NISKOŠUMNA CIJEV SILENT	75/25	60	13320
0175016	NISKOŠUMNA CIJEV SILENT	75/50	60	13321
0175017	NISKOŠUMNA CIJEV SILENT	75/100	56	13323
0175018	NISKOŠUMNA CIJEV SILENT	75/200	56	13325
0175019	NISKOŠUMNA CIJEV SILENT	75/300	56	13326
0175020	NISKOŠUMNA CIJEV SILENT	75/400	56	13327
0175021	NISKOŠUMNA CIJEV SILENT	110/25	40	13328
0175022	NISKOŠUMNA CIJEV SILENT	110/50	40	13329
0175023	NISKOŠUMNA CIJEV SILENT	110/100	30	13331
0175024	NISKOŠUMNA CIJEV SILENT	110/200	30	13333
0175025	NISKOŠUMNA CIJEV SILENT	110/300	30	13334
0175026	NISKOŠUMNA CIJEV SILENT	110/400	30	13335
0175027	NISKOŠUMNA CIJEV SILENT	125/25	28	13336
0175028	NISKOŠUMNA CIJEV SILENT	125/50	28	13337
0175029	NISKOŠUMNA CIJEV SILENT	125/100	24	13339
0175030	NISKOŠUMNA CIJEV SILENT	125/200	24	13341
0175031	NISKOŠUMNA CIJEV SILENT	125/300	24	13342
0175032	NISKOŠUMNA CIJEV SILENT	125/400	24	13343
0175033	NISKOŠUMNA CIJEV SILENT	160/25	18	13344
0175034	NISKOŠUMNA CIJEV SILENT	160/50	18	13345
0175035	NISKOŠUMNA CIJEV SILENT	160/100	18	13347
0175036	NISKOŠUMNA CIJEV SILENT	160/200	18	13349
0175037	NISKOŠUMNA CIJEV SILENT	160/300	18	13350
0175038	NISKOŠUMNA CIJEV SILENT	160/400	18	13351



PP KOLJENO

VOKEL ŠIFRA	OPIS	DIMENZIJA (Ø)	PAKIRANJE (pak/kom)	ARTIKAL
<b>0175043</b>	NISKOŠUMNO KOLJENO	50/15°C	20	13424
<b>0175047</b>	NISKOŠUMNO KOLJENO	75/15°C	20	13428
<b>0175051</b>	NISKOŠUMNO KOLJENO	110/15°C	20	13433
<b>0175055</b>	NISKOŠUMNO KOLJENO	125/15°C	20	13438
<b>0175059</b>	NISKOŠUMNO KOLJENO	160/15°C	6	13443
<b>0175044</b>	NISKOŠUMNO KOLJENO	50/30°C	20	13425
<b>0175048</b>	NISKOŠUMNO KOLJENO	75/30°C	20	13429
<b>0175052</b>	NISKOŠUMNO KOLJENO	110/30°C	20	13434
<b>0175056</b>	NISKOŠUMNO KOLJENO	125/30°C	20	13439
<b>0175060</b>	NISKOŠUMNO KOLJENO	160/30°C	6	13444
<b>0175039</b>	NISKOŠUMNO KOLJENO	32/45°C	70	25229
<b>0175041</b>	NISKOŠUMNO KOLJENO	40/45°C	20	25231
<b>0175045</b>	NISKOŠUMNO KOLJENO	50/45°C	20	13426
<b>0175049</b>	NISKOŠUMNO KOLJENO	75/45°C	20	13430
<b>0175053</b>	NISKOŠUMNO KOLJENO	110/45°C	20	13435
<b>0175057</b>	NISKOŠUMNO KOLJENO	125/45°C	20	13440
<b>0175061</b>	NISKOŠUMNO KOLJENO	160/45°C	6	13445
<b>0175040</b>	NISKOŠUMNO KOLJENO	32/90°C	70	25230
<b>0175045</b>	NISKOŠUMNO KOLJENO	40/90°C	20	25232
<b>0175046</b>	NISKOŠUMNO KOLJENO	50/90°C	20	13427
<b>0175050</b>	NISKOŠUMNO KOLJENO	75/90°C	20	13432
<b>0175054</b>	NISKOŠUMNO KOLJENO	110/90°C	20	13437
<b>0175058</b>	NISKOŠUMNO KOLJENO	125/90°C	20	13442
<b>0175062</b>	NISKOŠUMNO KOLJENO	160/90°C	4	13447



PP RAČVA 40°

VOKEL ŠIFRA	OPIS	DIMENZIJA (Ø)	PAKIRANJE (pak/kom)	ARTIKAL
<b>0175063</b>	NISKOŠUMNA RAČVA 45°	32/32/45°	20	25233
<b>0175064</b>	NISKOŠUMNA RAČVA 45°	40/40/45°	20	25235
<b>0175066</b>	NISKOŠUMNA RAČVA 45°	50/40/45°	20	27157
<b>0175065</b>	NISKOŠUMNA RAČVA 45°	50/50/45°	20	13448
<b>0175068</b>	NISKOŠUMNA RAČVA 45°	75/50/45°	20	13452
<b>0175067</b>	NISKOŠUMNA RAČVA 45°	75/75/45°	20	13450
<b>0175070</b>	NISKOŠUMNA RAČVA 45°	110/50/45°	20	13456
<b>0175071</b>	NISKOŠUMNA RAČVA 45°	110/75/45°	16	13458
<b>0175069</b>	NISKOŠUMNA RAČVA 45°	110/110/45°	16	13454
<b>0175073</b>	NISKOŠUMNA RAČVA 45°	125/110/45°	6	13462
<b>0175072</b>	NISKOŠUMNA RAČVA 45°	125/125/45°	5	13460
<b>0175075</b>	NISKOŠUMNA RAČVA 45°	160/110/45°	6	13466
<b>0175076</b>	NISKOŠUMNA RAČVA 45°	160/125/45°	6	13468
<b>0175074</b>	NISKOŠUMNA RAČVA 45°	160/160/45°	4	13464



PP RAČVA 90°

VOKEL ŠIFRA	OPIS	DIMENZIJA (Ø)	PAKIRANJE (pak/kom)	ARTIKAL
<b>0175077</b>	NISKOŠUMNA RAČVA 90°	32/32/90°	20	25234
<b>0175078</b>	NISKOŠUMNA RAČVA 90°	40/40/90°	20	25236
<b>0175080</b>	NISKOŠUMNA RAČVA 90°	50/40/90°	20	27159
<b>0175079</b>	NISKOŠUMNA RAČVA 90°	50/50/90°	20	13449
<b>0175082</b>	NISKOŠUMNA RAČVA 90°	75/50/90°	20	13453
<b>0175081</b>	NISKOŠUMNA RAČVA 90°	75/75/90°	20	13451
<b>0175084</b>	NISKOŠUMNA RAČVA 90°	110/50/90°	24	13457
<b>0175085</b>	NISKOŠUMNA RAČVA 90°	110/75/90°	20	13459
<b>0175083</b>	NISKOŠUMNA RAČVA 90°	110/110/90°	14	13455
<b>0175087</b>	NISKOŠUMNA RAČVA 90°	125/110/90°	8	13463
<b>0175086</b>	NISKOŠUMNA RAČVA 90°	125/125/90°	6	13461
<b>0175089</b>	NISKOŠUMNA RAČVA 90°	160/110/90°	10	13467
<b>0175090</b>	NISKOŠUMNA RAČVA 90°	160/125/90°	6	13469
<b>0175088</b>	NISKOŠUMNA RAČVA 90°	160/160/90°	6	13465





PP DVOSTRANA RAČVA

VOKEL ŠIFRA	OPIS	DIMENZIJA (Ø)	PAKIRANJE (pak/kom)	ARTIKAL
<b>0175091</b>	NISKOŠUMNA DVOSTRUKA RAČVA	50/50/50/45°	20	13470
<b>0175093</b>	NISKOŠUMNA DVOSTRUKA RAČVA	110/110/110/45°	6	13474
<b>0175092</b>	NISKOŠUMNA DVOSTRUKA RAČVA	50/50/50/90°	20	13471
<b>0175094</b>	NISKOŠUMNA DVOSTRUKA RAČVA	110/110/110/90°	6	13475



PP KLIZNA SPOJKA

VOKEL ŠIFRA	OPIS	DIMENZIJA (Ø)	PAKIRANJE (pak/kom)	ARTIKAL
<b>0175095</b>	NISKOŠUMNA KLIZNA SPOJKA	40	20	25237
<b>0175096</b>	NISKOŠUMNA KLIZNA SPOJKA	50	20	13476
<b>0175097</b>	NISKOŠUMNA KLIZNA SPOJKA	75	20	13477
<b>0175098</b>	NISKOŠUMNA KLIZNA SPOJKA	110	20	13478
<b>0175099</b>	NISKOŠUMNA KLIZNA SPOJKA	125	8	13479
<b>0175100</b>	NISKOŠUMNA KLIZNA SPOJKA	160	12	13480



PP REDUKCIJA

VOKEL ŠIFRA	OPIS	DIMENZIJA (Ø)	PAKIRANJE (pak/kom)	ARTIKAL
<b>0175101</b>	NISKOŠUMNA REDUKCIJA	40/32	20	25240
<b>0175102</b>	NISKOŠUMNA REDUKCIJA	50/32	20	25241
<b>0175103</b>	NISKOŠUMNA REDUKCIJA	50/40	20	25242
<b>0175104</b>	NISKOŠUMNA REDUKCIJA	75/40	20	25243
<b>0175105</b>	NISKOŠUMNA REDUKCIJA	75/50	20	13481
<b>0175106</b>	NISKOŠUMNA REDUKCIJA	110/50	20	13482
<b>0175107</b>	NISKOŠUMNA REDUKCIJA	110/75	20	13483
<b>0175108</b>	NISKOŠUMNA REDUKCIJA	125/110	12	13484
<b>0175109</b>	NISKOŠUMNA REDUKCIJA	160/110	20	13485
<b>0175110</b>	NISKOŠUMNA REDUKCIJA	160/125	14	13486



PP ČISTAČ

VOKEL ŠIFRA	OPIS	DIMENZIJA (Ø)	PAKIRANJE (pak/kom)	ARTIKAL
<b>0175111</b>	NISKOŠUMNI ČISTAČ	50	25	13487
<b>0175112</b>	NISKOŠUMNI ČISTAČ	75	20	13488
<b>0175113</b>	NISKOŠUMNI ČISTAČ	110	20	13489
<b>0175114</b>	NISKOŠUMNI ČISTAČ	125	8	13490
<b>0175115</b>	NISKOŠUMNI ČISTAČ	160	6	13491





PP ČEP

VOKEL ŠIFRA	OPIS	DIMENZIJA (Ø)	PAKIRANJE (pak/kom)	ARTIKAL
<b>0175116</b>	NISKOŠUMNI ČEP	32	100	25238
<b>0175117</b>	NISKOŠUMNI ČEP	40	100	25239
<b>0175118</b>	NISKOŠUMNI ČEP	50	100	13492
<b>0178119</b>	NISKOŠUMNI ČEP	75	100	13493
<b>0175120</b>	NISKOŠUMNI ČEP	110	80	13494
<b>0175121</b>	NISKOŠUMNI ČEP	125	60	13495
<b>0175122</b>	NISKOŠUMNI ČEP	160	30	13496







**UKC/PVC**  
**CIJEVI I SPOJEVI**



UKC/PVC CIJEVI I SPOJEVI			PAKIRANJE
	<b>0176010</b> <b>0176022</b> <b>0176011</b> <b>0176019</b>	UKC CIJEV TROSLOJNA Ø 110/25 cm PEŠTAN SDR41 SN4	600
		UKC CIJEV TROSLOJNA Ø 110/50 cm PEŠTAN SDR41 SN4	200
		UKC CIJEV TROSLOJNA Ø 110/100 cm PEŠTAN SDR41 SN4	76
		UKC CIJEV TROSLOJNA Ø 110/200 cm PEŠTAN SDR41 SN4	76
		UKC CIJEV TROSLOJNA Ø 110/300 cm PEŠTAN SDR41 SN4	76
		UKC CIJEV TROSLOJNA Ø 110/400 cm PEŠTAN SDR41 SN4	76
	<b>0176017</b> <b>0176018</b> <b>0176020</b> <b>0176013</b>	UKC CIJEV TROSLOJNA Ø 125/25 cm PEŠTAN SDR41 SN4	540
		UKC CIJEV TROSLOJNA Ø 125/50 cm PEŠTAN SDR41 SN4	160
		UKC CIJEV TROSLOJNA Ø 125/100 cm PEŠTAN SDR41 SN4	60
		UKC CIJEV TROSLOJNA Ø 125/200 cm PEŠTAN SDR41 SN4	60
		UKC CIJEV TROSLOJNA Ø 125/300 cm PEŠTAN SDR41 SN4	60
		UKC CIJEV TROSLOJNA Ø 125/400 cm PEŠTAN SDR41 SN4	60
	<b>0176029</b> <b>0176028</b> <b>0176030</b> <b>0176031</b>	UKC CIJEV TROSLOJNA Ø 160/25 cm PEŠTAN SDR41 SN4	200
		UKC CIJEV TROSLOJNA Ø 160/50 cm PEŠTAN SDR41 SN4	96
		UKC CIJEV TROSLOJNA Ø 160/100 cm PEŠTAN SDR41 SN4	52
		UKC CIJEV TROSLOJNA Ø 160/200 cm PEŠTAN SDR41 SN4	53
		UKC CIJEV TROSLOJNA Ø 160/300 cm PEŠTAN SDR41 SN4	53
		UKC CIJEV TROSLOJNA Ø 160/400 cm PEŠTAN SDR41 SN4	53
	<b>0176025</b> <b>0176026</b> <b>0176027</b> <b>0176032</b>	UKC CIJEV TROSLOJNA Ø 200/25 cm PEŠTAN SDR41 SN4	60
		UKC CIJEV TROSLOJNA Ø 200/50 cm PEŠTAN SDR41 SN4	30
		UKC CIJEV TROSLOJNA Ø 200/100 cm PEŠTAN SDR41 SN4	30
		UKC CIJEV TROSLOJNA Ø 200/200 cm PEŠTAN SDR41 SN4	30
		UKC CIJEV TROSLOJNA Ø 200/300 cm PEŠTAN SDR41 SN4	30
		UKC CIJEV TROSLOJNA Ø 200/400 cm PEŠTAN SDR41 SN4	30
	<b>0176038</b> <b>0176034</b> <b>0176039</b> <b>0176040</b>	UKC CIJEV TROSLOJNA Ø 250/25 cm PEŠTAN SDR41 SN4	60
		UKC CIJEV TROSLOJNA Ø 250/50 cm PEŠTAN SDR41 SN4	40
		UKC CIJEV TROSLOJNA Ø 250/100 cm PEŠTAN SDR41 SN4	20
		UKC CIJEV TROSLOJNA Ø 250/200 cm PEŠTAN SDR41 SN4	20
UKC CIJEV TROSLOJNA Ø 250/300 cm PEŠTAN SDR41 SN4		20	
UKC CIJEV TROSLOJNA Ø 250/400 cm PEŠTAN SDR41 SN4		20	
<b>0176036</b> <b>0176035</b> <b>0176037</b> <b>0176033</b>	UKC CIJEV TROSLOJNA Ø 315/25 cm PEŠTAN SDR41 SN4	*	
	UKC CIJEV TROSLOJNA Ø 315/50 cm PEŠTAN SDR41 SN4	12	
	UKC CIJEV TROSLOJNA Ø 315/100 cm PEŠTAN SDR41 SN4	12	
	UKC CIJEV TROSLOJNA Ø 315/200 cm PEŠTAN SDR41 SN4	12	
	UKC CIJEV TROSLOJNA Ø 315/300 cm PEŠTAN SDR41 SN4	12	
	UKC CIJEV TROSLOJNA Ø 315/400 cm PEŠTAN SDR41 SN4	12	
	UKC CIJEV TROSLOJNA Ø 315/600 cm PEŠTAN SDR41 SN4	12	

UKC/PVC CIJEVI I SPOJEVI			PAKIRANJE
	<b>0173007</b>	PVC RAČVA Ø 110/110/45° PEŠTAN	20
	<b>0173008</b>	PVC RAČVA Ø 125/110/45° PEŠTAN	16
	<b>0173009</b>	PVC RAČVA Ø 125/125/45° PEŠTAN	12
	<b>0173010</b>	PVC RAČVA Ø 160/110/45° PEŠTAN	9
	<b>0173063</b>	PVC RAČVA Ø 160/125/45° PEŠTAN	8
	<b>0173011</b>	PVC RAČVA Ø 160/160/45° PEŠTAN	6
	<b>0173014</b>	PVC RAČVA Ø 200/110/45° PEŠTAN	15
	<b>0173012</b>	PVC RAČVA Ø 200/125/45° PEŠTAN	15
	<b>0173013</b>	PVC RAČVA Ø 200/160/45° PEŠTAN	13
	<b>0173015</b>	PVC RAČVA Ø 200/200/45° PEŠTAN	10
	<b>0173056</b>	PVC RAČVA Ø 250/110/45° PEŠTAN	6
	<b>0173064</b>	PVC RAČVA Ø 250/125/45° PEŠTAN	6
	<b>0173016</b>	PVC RAČVA Ø 250/160/45° PEŠTAN	6
		PVC RAČVA Ø 250/200/45° PEŠTAN	5
	<b>0173057</b>	PVC RAČVA Ø 250/250/45° PEŠTAN	3
	<b>0173058</b>	PVC RAČVA Ø 315/110/45° PEŠTAN	4
	<b>0173059</b>	PVC RAČVA Ø 315/125/45° PEŠTAN	4
	<b>0173060</b>	PVC RAČVA Ø 315/160/45° PEŠTAN	4
		PVC RAČVA Ø 315/200/45° PEŠTAN	4
	<b>0173061</b>	PVC RAČVA Ø 315/250/45° PEŠTAN	2
	PVC RAČVA Ø 315/315/45° PEŠTAN	2	
	<b>0173046</b>	PVC RAČVA Ø 110/110/90° PEŠTAN	25
	<b>0173065</b>	PVC RAČVA Ø 125/110/90° PEŠTAN	19
	<b>0173066</b>	PVC RAČVA Ø 125/125/90° PEŠTAN	16
	<b>0173067</b>	PVC RAČVA Ø 160/110/90° PEŠTAN	12
		PVC RAČVA Ø 160/125/90° PEŠTAN	10
	<b>0173017</b>	PVC RAČVA Ø 160/160/90° PEŠTAN	8
	<b>0173068</b>	PVC RAČVA Ø 200/110/90° PEŠTAN	20
		PVC RAČVA Ø 200/125/90° PEŠTAN	18
		PVC RAČVA Ø 200/160/90° PEŠTAN	16
	<b>0173069</b>	PVC RAČVA Ø 200/200/90° PEŠTAN	13
		PVC RAČVA Ø 250/110/90° PEŠTAN	11
		PVC RAČVA Ø 250/125/90° PEŠTAN	10
		PVC RAČVA Ø 250/160/90° PEŠTAN	9
		PVC RAČVA Ø 250/200/90° PEŠTAN	8
	<b>0173062</b>	PVC RAČVA Ø 250/250/90° PEŠTAN	6
		PVC RAČVA Ø 315/110/90° PEŠTAN	5
		PVC RAČVA Ø 315/125/90° PEŠTAN	5
		PVC RAČVA Ø 315/160/90° PEŠTAN	5
		PVC RAČVA Ø 315/200/90° PEŠTAN	5
		PVC RAČVA Ø 315/250/90° PEŠTAN	4
	PVC RAČVA Ø 315/315/90° PEŠTAN	2	



UKC CIJEVI I SPOJEVI			PAKIRANJE
	<b>0173051</b>	PVC KOLJENO Ø 110/15° PEŠTAN	60
	<b>0173052</b>	PVC KOLJENO Ø 125/15° PEŠTAN	40
	<b>0173053</b>	PVC KOLJENO Ø 160/15° PEŠTAN	20
	<b>0173031</b>	PVC KOLJENO Ø 200/15° PEŠTAN	10
		PVC KOLJENO Ø 250/15° PEŠTAN	*
		PVC KOLJENO Ø 315/15° PEŠTAN	*
	<b>0173054</b>	PVC KOLJENO Ø 110/30° PEŠTAN	50
	<b>0173055</b>	PVC KOLJENO Ø 125/30° PEŠTAN	35
	<b>0173032</b>	PVC KOLJENO Ø 160/30° PEŠTAN	17
	<b>0173033</b>	PVC KOLJENO Ø 200/30° PEŠTAN	7/24
		PVC KOLJENO Ø 250/30° PEŠTAN	*
		PVC KOLJENO Ø 315/30° PEŠTAN	*
	<b>0173001</b>	PVC KOLJENO Ø 110/45° PEŠTAN	50
	<b>0173030</b>	PVC KOLJENO Ø 125/45° PEŠTAN	30
	<b>0173002</b>	PVC KOLJENO Ø 160/45° PEŠTAN	15
	<b>0173003</b>	PVC KOLJENO Ø 200/45° PEŠTAN	8
	<b>0173005</b>	PVC KOLJENO Ø 250/45° PEŠTAN	7
	<b>0173034</b>	PVC KOLJENO Ø 315/45° PEŠTAN	6
		PVC KOLJENO Ø 110/90° PEŠTAN	40
		PVC KOLJENO Ø 125/90° PEŠTAN	25
		PVC KOLJENO Ø 160/90° PEŠTAN	12
	<b>0173004</b>	PVC KOLJENO Ø 200/90° PEŠTAN	6
	<b>0173006</b>	PVC KOLJENO Ø 250/90° PEŠTAN	8
	<b>0173035</b>	PVC KOLJENO Ø 315/90° PEŠTAN	4
	<b>0173049</b>	KLIZNA SPOJKA DN 110 PEŠTAN	60
	<b>0173073</b>	KLIZNA SPOJKA DN 125 PEŠTAN	45
	<b>0173050</b>	KLIZNA SPOJKA DN 160 PEŠTAN	18
	<b>0173024</b>	KLIZNA SPOJKA DN 200 PEŠTAN	33
	<b>0173025</b>	KLIZNA SPOJKA DN 250 PEŠTAN	12
	<b>0173048</b>	KLIZNA SPOJKA DN 315 PEŠTAN	7
	<b>0173029</b>	PVC REDUKCIJA DN 125/110 PEŠTAN	48
	<b>0173018</b>	PVC REDUKCIJA DN 160/110 PEŠTAN	36
	<b>0173019</b>	PVC REDUKCIJA DN 160/125 PEŠTAN	36
	<b>0173070</b>	PVC REDUKCIJA DN 200/110 PEŠTAN	44
	<b>0173021</b>	PVC REDUKCIJA DN 200/160 PEŠTAN	42
	<b>0173022</b>	PVC REDUKCIJA DN 250/200 PEŠTAN	26
	<b>0173071</b>	PVC REDUKCIJA DN 315/200 PEŠTAN	
	<b>0173072</b>	PVC REDUKCIJA DN 315/250 PEŠTAN	16

UKC CIJEVI I SPOJEVI			PAKIRANJE
	<b>0173020</b>	PVC REDUKCIJA RAVNA DN 110/200 PEŠTAN	*
		PVC REDUKCIJA RAVNA DN 110/250 PEŠTAN	*
		PVC REDUKCIJA RAVNA DN 110/315 PEŠTAN	*
		PVC REDUKCIJA RAVNA DN 125/200 PEŠTAN	<b>20</b>
		PVC REDUKCIJA RAVNA DN 125/250 PEŠTAN	*
		PVC REDUKCIJA RAVNA DN 125/315 PEŠTAN	*
		PVC REDUKCIJA RAVNA DN 160/250 PEŠTAN	*
		PVC REDUKCIJA RAVNA DN 160/315 PEŠTAN	*
		PVC REDUKCIJA RAVNA DN 200/315 PEŠTAN	*
	<b>0173037</b>	PVC ČISTAČ DN 110/110 PEŠTAN	30
	<b>0173038</b>	PVC ČISTAČ DN 125/110 PEŠTAN	20
	<b>0173039</b>	PVC ČISTAČ DN 160/160 PEŠTAN	9
	<b>0173041</b>	PVC ČISTAČ DN 200/160 PEŠTAN	17
		PVC ČISTAČ DN 250/160 PEŠTAN	9
		PVC ČISTAČ DN 315/160 PEŠTAN	5
	<b>0173026</b>	ČEP PVC Ø 110 PEŠTAN	*
		ČEP PVC Ø 125 PEŠTAN	*
	<b>0173027</b>	ČEP PVC Ø 160 PEŠTAN	45
	<b>0173028</b>	ČEP PVC Ø 200 PEŠTAN	25
	<b>0173040</b>	ČEP PVC Ø 250 PEŠTAN	51
	<b>0173042</b>	VENTIL NEPOVRATNI Ø 110 PEŠTAN	1
	<b>0173043</b>	VENTIL NEPOVRATNI Ø 125 PEŠTAN	1
	<b>0173044</b>	VENTIL NEPOVRATNI Ø 160 PEŠTAN	1
	<b>0173045</b>	VENTIL NEPOVRATNI Ø 200 PEŠTAN	1
		VENTIL NEPOVRATNI Ø 250 PEŠTAN	1
		VENTIL NEPOVRATNI Ø 310 PEŠTAN	1

**USISAVAČ ZA HLADNI PEPEO S HEPA FILTEROM**



tank: 15 l  
 snaga: 800 W  
 duljina kabela: 3 m  
 duljina usisnog crijeva: 2 m  
 promjer usisnog crijeva: 30 mm



Vokel šifra	Opis	Snaga (W)	Art.
<b>1463001</b>	Usisavač za hladni pepeo	800	MWA503C-15L-800W
<b>1463002</b>	Hepa filter za Windy Plus usisavač	-	D401-Z103H124



**POLIKA**  
WC ŠKOLJKA VISEĆA

Vokel šifra	Opis	Dimenzije (cm)	Paleta (kom)	Šifra artikla
<b>1714009</b>	POLIKA	35,4x52,6	18	PERTH WC WH



**UMIVAONIK ATLAS**  
55x46 cm

Vokel šifra	Opis	Dimenzije (cm)	Paleta (kom)
<b>1714003</b>	Atlas	55x46	24

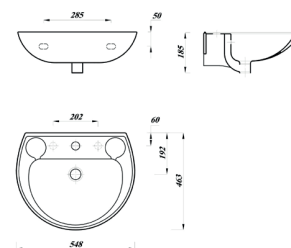

**UMIVAONIK ATLAS GEO**  
60x45 cm

Vokel šifra	Opis	Dimenzije (cm)	Paleta (kom)
<b>1714004</b>	Atlas Geo	60x45	24

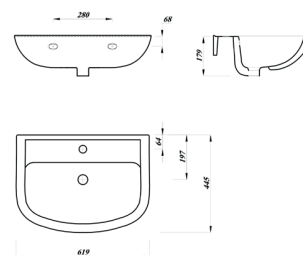

**UMIVAONIK SOLLIA**  
UGRADNI 53x43 cm

Vokel šifra	Opis	Dimenzije (cm)	Paleta (kom)
<b>1714005</b>	Sollia - ugradni	53x43	16

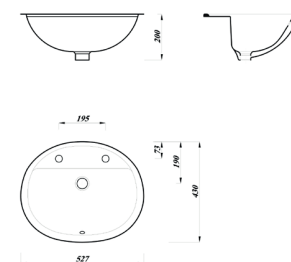



Podžbukni set Elite se sastoji od:

- mješač
- rozeta
- zidni priključak
- tuš glava
- držač tuša
- tuš ručica
- crijevo
- zidni držač

ŠIFRA VOKEL	OPIS	BOJA	ART.
<b>1176018</b>	PODŽBUKNI SET-MJEŠAČ ELITE DUO	KROM	00377



### BATERIJA DUO - PODŽBUKNI SET

MLAZNICA TUŠA, RUČICA TUŠA, ZIDNI DRŽAČ TUŠA, ZIDNI PRIKLJUČAK, DRŽAČ TUŠ RUČICE, CRIJEVO, ROZETA I RUČICA, UZIDNA MJEŠALICA

ŠIFRA VOKEL	BOJA	ŠIFRA ARTIKLA	PAKIRANJE
<b>0420032</b>	KROM	00371	1

### TERMOSTATSKA PODŽBUKNA BATERIJA

+ NADŽBUKNI DIO



ŠIFRA VOKEL	BOJA	ŠIFRA ARTIKLA	PAKIRANJE
<b>1131043</b>	KROM	00399	1

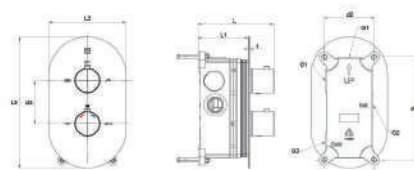

Order No.	L [mm]	L1 [mm]	L2 [mm]	L3 [mm]	d1 [mm]	d2 [mm]	d3 [mm]	f [mm]	C1 [in]	C2 [in]
040399	130P	91.65	140.2	45	193.70	28	62	2	12.2	2.4



## ER serija za grijanje

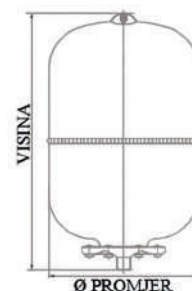

MODEL	KAPACITET [litara]	VOKEL ŠIFRA	VISINA [mm]	PROMJER [mm]	TLAK [bar]	NAVOJ [inč]
ER-24 CE	24	<b>1466001</b>	355	320	1,5-8	3/4"

## ERCE serija za grijanje

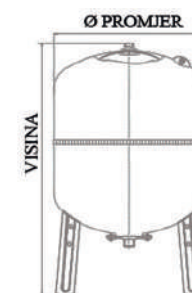

MODEL	KAPACITET [litara]	VOKEL ŠIFRA	VISINA [mm]	PROMJER [mm]	TLAK [bar]	NAVOJ [inč]
ERCE-35	35	<b>1466002</b>	390	400	1,5-10	3/4"
ERCE-35 S NOG.	35	<b>1466003</b>	390	400	1,5-10	3/4"
ERCE-50	50	<b>1466004</b>	500	400	1,5-10	3/4"
ERCE-50 S NOG.	50	<b>1466005</b>	500	400	1,5-10	3/4"
ERCE-80	80	<b>1466006</b>	840	400	1,5-10	1"
ERCE-100	100	<b>1466007</b>	795	500	1,5-10	1"
ERCE-200	200	<b>1466022</b>	1020	600	1,5-10	1"
ERCE-300	300	<b>1466008</b>	1265	650	1,5-10	1"

## DP serija za sanitarnu vodu

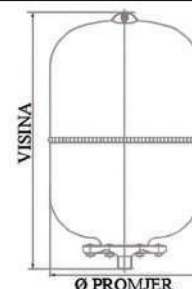

MODEL	KAPACITET [litara]	VOKEL ŠIFRA	VISINA [mm]	PROMJER [mm]	TLAK [bar]	NAVOJ [inč]
DP5 CE	5	<b>1466009</b>	225	205	3-10	3/4"
DP8 CE	8	<b>1466010</b>	300	205	3-10	3/4"
DP11	11	<b>1466011</b>	300	270	3-10	3/4"
DP24	24	<b>1466012</b>	355	320	3-10	1"
DP35	35	<b>1466013</b>	390	400	3-10	1"

## DPV serija

za sanitarnu vodu

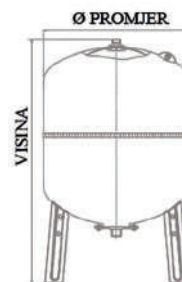

MODEL	KAPACITET [litara]	VOKEL ŠIFRA	VISINA [mm]	PROMJER [mm]	TLAK [bar]	NAVOJ [inč]
DPV50	50	<b>1466014</b>	585	400	3-10	1"
DPV100	100	<b>1466015</b>	775	500	3-10	5/4"

## DS serija

za solarno

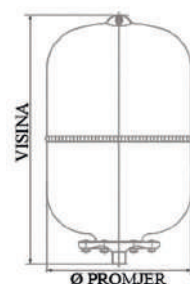

MODEL	KAPACITET [litara]	VOKEL ŠIFRA	VISINA [mm]	PROMJER [mm]	TLAK [bar]	NAVOJ [inč]
DS18-CE	18	<b>1466016</b>	410	270	3-8	3/4"

## DSV serija

za solarno

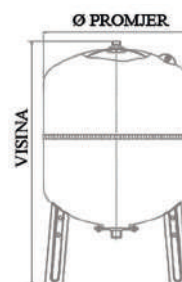

MODEL	KAPACITET [litara]	VOKEL ŠIFRA	VISINA [mm]	PROMJER [mm]	TLAK [bar]	NAVOJ [inč]
DSV80-CE	80	<b>1466017</b>	840	400	3-10	1"
DSV100-CE	100	<b>1466018</b>	795	500	3-10	1"

## ERP 320 serija

za grijanje

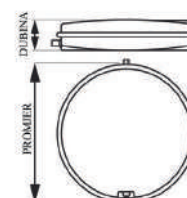

MODEL	KAPACITET [litara]	VOKEL ŠIFRA	DUBINA [mm]	PROMJER [mm]	TLAK [bar]	NAVOJ [inč]
ERP320/10	10	<b>1466019</b>	131	320	1-3	3/4"

## ERP-RET serija

za grijanje

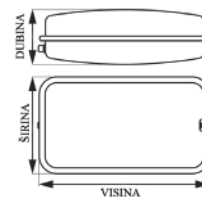

MODEL	KAPACITET [litara]	VOKEL ŠIFRA	VISINA [mm]	ŠIRINA [mm]	DUBINA [mm]	TLAK [bar]	NAVOJ [inč]
ERPRET/10	10	<b>1466020</b>	516	196	124	1-3	3/4"
ERPRET/12	12	<b>1466021</b>	516	196	152	1-3	3/4"

# Aria

## GLAVNE KARAKTERISTIKE:

- Čvrstoća, homogenost i dugotrajnost
- Moderan i elegantan dizajn
- Otpornost na udarce, abraziju i ogrebotine
- Jednostavnost održavanja i čišćenja
- Antibakterijski proizvod sa hipoalergenim svojstvima
- Otporan na vatru, toplinu i vlagu
- Nepodložan plijesni, truljenju i propadanju

CRNA & BIJELA

JEZGRA ISPUNE PLOČE



# 6

dekorativnih uzorka



Tobacco



Black



Honey



Calacatta



Grey



White



## Preporučene mjere ugradnje:

Aria Compact Top  
(gornja ploča)

➔ 75-80 cm od poda

Aria Compact Base  
(ladica+pokrovnna ploča)

➔ 10 cm od poda

## ARIA COMPACT

Zahvaljujući višeslojnoj strukturi od papira impregniranih smolom i dekorativnog površinskog sloja, compact ploče posebno su prikladne za površine koje se učestalo koriste.

Primjena ovih ploča u zadnjem desetljeću višestruko je uvećana, tako ih sada možemo pronaći u raznim dijelovima kućanstva poput kupaonskog namještaja ili kuhinjskih ploha pa sve do površina u medicinskim laboratorijima zbog svojih visokih antibakterijskih svojstava.

### ZNAČAJKE:

- Čvrstoća, homogenost i dugotrajnost
- Moderan i elegantan dizajn
- Otpornost na udarce, abraziju i ogrebotine
- Jednostavnost održavanja i čišćenja
- Antibakterijski proizvod sa hipoalergenim svojstvima
- Otporan na vatru, toplinu i vlagu
- Nepodložan plijesni, truljenju i propadanju

### MOGUĆNOSTI I MONTAŽA

- Visina ugradnje je proizvoljna, ovisna o prostoru, visini umivaonika, ostavljenim izvodima vode
- Mogućnost izrade namještaja prema posebnim/željenim dimenzijama
- Namještaj, gornja ploča bez rupa za bateriju i umivaonik tako da kupac sam buši rupu prema želji zbog položaja umivaonika
- Pokrovnu ploču baze potrebno je zalijepiti multifunkcionalnim lijepilom ili silikonom
- Namještaji dolaze sa podesivim nosačima ali bez ručica jer kupac može birati jednu od ponuđene 4 vrste ručica iz ponude
- Uz namještaj NE dolaze vijci za montažu
- Zid na koji se namještaj montira ukoliko nije betonski treba ojačati kako bi se namještaj mogao pravilno montirati

Kombinacija izdržljivosti i elegantnog dizajna čini ARIA COMPACT namještaj odličnim i suvremenim rješenjem za privatne i komercijalne interijere.





GLAVNE KARAKTERISTIKE:

- Čvrstoća, homogenost i dugotrajnost
- Otpornost na ogrebotine, toplinu i vlagu
- Antibakterijski sa hipoalergenim svojstvima
- Jednostavnost održavanja i čišćenja



VOKEL ŠIFRA	OPIS	ART.
KOMPOZICIJA ARIA COMPACT TOBACCO 70 cm		
<b>1716001</b>	ARIA COMPACT TOP, PLOČA ZA UMIVAONIK, 70x52x13, S NOSAČIMA	ACT70T
<b>1718001</b>	ARIA COMPACT BASE, LADICA + POKROVNA PLOČA, 70x50x26	ACB70T
KOMPOZICIJA ARIA COMPACT TOBACCO 90 cm		
<b>1716005</b>	ARIA COMPACT TOP, PLOČA ZA UMIVAONIK, 90x52x13, S NOSAČIMA	ACT90T
<b>1718005</b>	ARIA COMPACT BASE, LADICA + POKROVNA PLOČA, 90x50x26	ACB90T
KOMPOZICIJA ARIA COMPACT TOBACCO 120 cm		
<b>1716009</b>	ARIA COMPACT TOP, PLOČA ZA UMIVAONIK, 102x52x13, S NOSAČIMA	ACT120T
<b>1717005</b>	ARIA COMPACT TOP, PLOČA ZA UMIVAONIK, IZREZ ZA RUČNIK, 120x52x13, S NOSAČIMA	ACTRR120T
<b>1718009</b>	ARIA COMPACT BASE, LADICA + POKROVNA PLOČA, 120x50x26	ACB120T
KOMPOZICIJA ARIA COMPACT TOBACCO 140 cm		
<b>1716013</b>	ARIA COMPACT TOP, PLOČA ZA UMIVAONIK, 140x52x13, S NOSAČIMA	ACT140T
<b>1717001</b>	ARIA COMPACT TOP, PLOČA ZA UMIVAONIK, IZREZ ZA RUČNIK, 140x52x13, S NOSAČIMA	ACTRR140T
<b>1718013</b>	ARIA COMPACT BASE, LADICA + POKROVNA PLOČA, 140x50x26	ACB140T



### GLAVNE KARAKTERISTIKE:

- Čvrstoća, homogenost i dugotrajnost
- Otpornost na ogrebotine, toplinu i vlagu
- Antibakterijski sa hipoalergenim svojstvima
- Jednostavnost održavanja i čišćenja

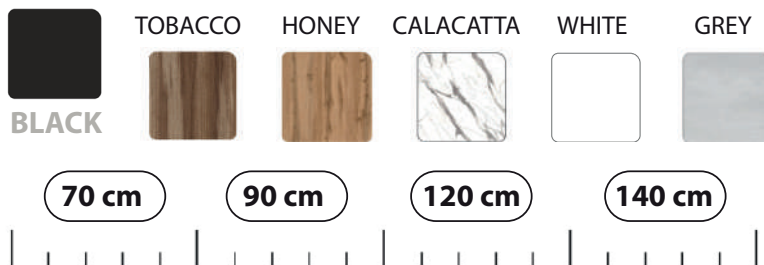

VOKEL ŠIFRA	OPIS	ART.
<b>KOMPOZICIJA ARIA COMPACT BLACK 70 cm</b>		
<b>1716002</b>	ARIA COMPACT TOP, PLOČA ZA UMIVAONIK, 70x52x13, S NOSAČIMA	ACT70B
<b>1718002</b>	ARIA COMPACT BASE, LADICA + POKROVNA PLOČA, 70x50x26	ACB70B
<b>KOMPOZICIJA ARIA COMPACT BLACK 90 cm</b>		
<b>1716006</b>	ARIA COMPACT TOP, PLOČA ZA UMIVAONIK, 90x52x13, S NOSAČIMA	ACT90B
<b>1718006</b>	ARIA COMPACT BASE, LADICA + POKROVNA PLOČA, 90x50x26	ACB90B
<b>KOMPOZICIJA ARIA COMPACT BLACK 120 cm</b>		
<b>1716011</b>	ARIA COMPACT TOP, PLOČA ZA UMIVAONIK, 120x52x13, S NOSAČIMA	ACT120B
<b>1717006</b>	ARIA COMPACT TOP, PLOČA ZA UMIVAONIK, IZREZ ZA RUČNIK, 120x52x13, S NOSAČIMA	ACTRR120B
<b>1718010</b>	ARIA COMPACT BASE, LADICA + POKROVNA PLOČA, 120x50x26	ACB120B
<b>KOMPOZICIJA ARIA COMPACT BLACK 140 cm</b>		
<b>1716014</b>	ARIA COMPACT TOP, PLOČA ZA UMIVAONIK, 140x52x13, S NOSAČIMA	ACT140B
<b>1717002</b>	ARIA COMPACT TOP, PLOČA ZA UMIVAONIK, IZREZ ZA RUČNIK, 140x52x13, S NOSAČIMA	ACTRR140B
<b>1718014</b>	ARIA COMPACT BASE, LADICA + POKROVNA PLOČA, 140x50x26	ACB140B



GLAVNE KARAKTERISTIKE:

- Čvrstoća, homogenost i dugotrajnost
- Otpornost na ogrebotine, toplinu i vlagu
- Antibakterijski sa hipoalergenim svojstvima
- Jednostavnost održavanja i čišćenja



VOKEL ŠIFRA	OPIS	ART.
KOMPOZICIJA ARIA COMPACT HONEY 70 cm		
<b>1716003</b>	ARIA COMPACT TOP, PLOČA ZA UMIVAONIK, 70x52x13, S NOSAČIMA	ACT70H
<b>1718003</b>	ARIA COMPACT BASE, LADICA + POKROVNA PLOČA, 70x50x26	ACB70H
KOMPOZICIJA ARIA COMPACT HONEY 90 cm		
<b>1716007</b>	ARIA COMPACT TOP, PLOČA ZA UMIVAONIK, 90x52x13, S NOSAČIMA	ACT90H
<b>1718007</b>	ARIA COMPACT BASE, LADICA + POKROVNA PLOČA, 90x50x26	ACB90H
KOMPOZICIJA ARIA COMPACT HONEY 120 cm		
<b>1716010</b>	ARIA COMPACT TOP, PLOČA ZA UMIVAONIK, 120x52x13, S NOSAČIMA	ACT120H
<b>1717007</b>	ARIA COMPACT TOP, PLOČA ZA UMIVAONIK, IZREZ ZA RUČNIK, 120x52x13, S NOSAČIMA	ACTRR120H
<b>1718011</b>	ARIA COMPACT BASE, LADICA + POKROVNA PLOČA, 120x50x26	ACB120H
KOMPOZICIJA ARIA COMPACT HONEY 140 cm		
<b>1716015</b>	ARIA COMPACT TOP, PLOČA ZA UMIVAONIK, 140x52x13, S NOSAČIMA	ACT140H
<b>1717003</b>	ARIA COMPACT TOP, PLOČA ZA UMIVAONIK, IZREZ ZA RUČNIK, 140x52x13, S NOSAČIMA	ACTRR140H
<b>1718015</b>	ARIA COMPACT BASE, LADICA + POKROVNA PLOČA, 140x50x26	ACB140H





### GLAVNE KARAKTERISTIKE:

- Čvrstoća, homogenost i dugotrajnost
- Otpornost na ogrebotine, toplinu i vlagu
- Antibakterijski sa hipoalergenim svojstvima
- Jednostavnost održavanja i čišćenja

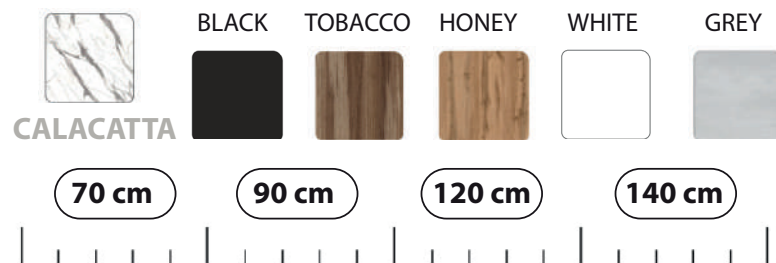

VOKEL ŠIFRA	OPIS	ART.
KOMPOZICIJA ARIA COMPACT CALACATTA 70 cm		
<b>1716004</b>	ARIA COMPACT TOP, PLOČA ZA UMIVAONIK, 70x52x13, S NOSAČIMA	ACT70C
<b>1718004</b>	ARIA COMPACT BASE, LADICA + POKROVNA PLOČA, 70x50x26	ACB70C
KOMPOZICIJA ARIA COMPACT CALACATTA 90 cm		
<b>1716008</b>	ARIA COMPACT TOP, PLOČA ZA UMIVAONIK, 90x52x13, S NOSAČIMA	ACT90C
<b>1718008</b>	ARIA COMPACT BASE, LADICA + POKROVNA PLOČA, 90x50x26	ACB90C
KOMPOZICIJA ARIA COMPACT CALACATTA 120 cm		
<b>1716012</b>	ARIA COMPACT TOP, PLOČA ZA UMIVAONIK, 120x52x13, S NOSAČIMA	ACT120C
<b>1717008</b>	ARIA COMPACT TOP, PLOČA ZA UMIVAONIK, IZREZ ZA RUČNIK, 120x52x13, S NOSAČIMA	ACTRR120C
<b>1718012</b>	ARIA COMPACT BASE, LADICA + POKROVNA PLOČA, 120x50x26	ACB120C
KOMPOZICIJA ARIA COMPACT CALACATTA 140 cm		
<b>1716016</b>	ARIA COMPACT TOP, PLOČA ZA UMIVAONIK, 140x52x13, S NOSAČIMA	ACT140C
<b>1717004</b>	ARIA COMPACT TOP, PLOČA ZA UMIVAONIK, IZREZ ZA RUČNIK, 140x52x13, S NOSAČIMA	ACTRR140C
<b>1718016</b>	ARIA COMPACT BASE, LADICA + POKROVNA PLOČA, 140x50x26	ACB140C



GLAVNE KARAKTERISTIKE:

- Čvrstoća, homogenost i dugotrajnost
- Otpornost na ogrebotine, toplinu i vlagu
- Antibakterijski sa hipoalergenim svojstvima
- Jednostavnost održavanja i čišćenja



VOKEL ŠIFRA	OPIS	ART.
KOMPOZICIJA ARIA COMPACT WHITE 70 cm		
<b>1716021</b>	ARIA COMPACT TOP, PLOČA ZA UMIVAONIK, 70x52x13, S NOSAČIMA	ACT70WH
<b>1718025</b>	ARIA COMPACT BASE, LADICA + POKROVNA PLOČA, 70x50x26	ACB70WH
KOMPOZICIJA ARIA COMPACT WHITE 90 cm		
<b>1716022</b>	ARIA COMPACT TOP, PLOČA ZA UMIVAONIK, 90x52x13, S NOSAČIMA	ACT90WH
<b>1718026</b>	ARIA COMPACT BASE, LADICA + POKROVNA PLOČA, 90x50x26	ACB90WH
KOMPOZICIJA ARIA COMPACT WHITE 120 cm		
<b>1716023</b>	ARIA COMPACT TOP, PLOČA ZA UMIVAONIK, 120x52x13, S NOSAČIMA	ACT120WH
<b>1718027</b>	ARIA COMPACT BASE, LADICA + POKROVNA PLOČA, 120x50x26	ACB120WH
KOMPOZICIJA ARIA COMPACT WHITE 140 cm		
<b>1716024</b>	ARIA COMPACT TOP, PLOČA ZA UMIVAONIK, 140x52x13, S NOSAČIMA	ACT140WH
<b>1718028</b>	ARIA COMPACT BASE, LADICA + POKROVNA PLOČA, 140x50x26	ACB140WH





### GLAVNE KARAKTERISTIKE:

- Čvrstoća, homogenost i dugotrajnost
- Otpornost na ogrebotine, toplinu i vlagu
- Antibakterijski sa hipoalergenim svojstvima
- Jednostavnost održavanja i čišćenja

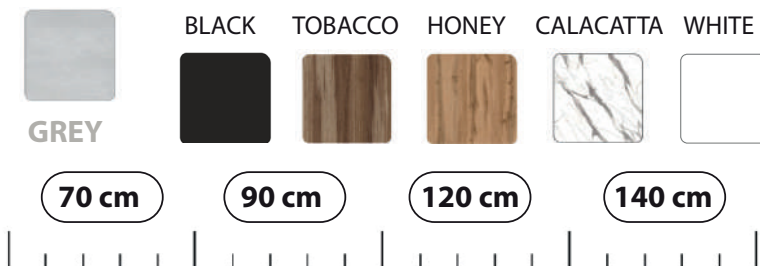

VOKEL ŠIFRA	OPIS	ART.
KOMPOZICIJA ARIA COMPACT GREY 70 cm		
<b>1716017</b>	ARIA COMPACT TOP, PLOČA ZA UMIVAONIK, 70x52x13, S NOSAČIMA	ACT70GR
<b>1718021</b>	ARIA COMPACT BASE, LADICA + POKROVNA PLOČA, 70x50x26	ACB70GR
KOMPOZICIJA ARIA COMPACT GREY 90 cm		
<b>1716018</b>	ARIA COMPACT TOP, PLOČA ZA UMIVAONIK, 90x52x13, S NOSAČIMA	ACT90GR
<b>1718022</b>	ARIA COMPACT BASE, LADICA + POKROVNA PLOČA, 90x50x26	ACB90GR
KOMPOZICIJA ARIA COMPACT GREY 120 cm		
<b>1716019</b>	ARIA COMPACT TOP, PLOČA ZA UMIVAONIK, 120x52x13, S NOSAČIMA	ACT120GR
<b>1718023</b>	ARIA COMPACT BASE, LADICA + POKROVNA PLOČA, 120x50x26	ACB120GR
KOMPOZICIJA ARIA COMPACT GREY 140 cm		
<b>1716020</b>	ARIA COMPACT TOP, PLOČA ZA UMIVAONIK, 140x52x13, S NOSAČIMA	ACT140GR
<b>1718024</b>	ARIA COMPACT BASE, LADICA + POKROVNA PLOČA, 140x50x26	ACB140GR



RUČKICA 001

ŠIFRA VOKEL	BOJA	DULJINA (mm)
<b>1718017</b>	CHROM	416



RUČKICA 004

ŠIFRA VOKEL	BOJA	DULJINA (mm)
<b>1718020</b>	SILVER MAT	416



RUČKICA 002

ŠIFRA VOKEL	BOJA	DULJINA (mm)
<b>1718018</b>	GOLD	416



RUČKICA 003

ŠIFRA VOKEL	BOJA	DULJINA (mm)
<b>1718019</b>	BLACK	416

# *Biamante*





Ø 70

Vokel šifra	Opis	Artikal
<b>1720026</b>	OGLEDALO AURELIA BLACK S LED RASVJETOM	BS-M2231B

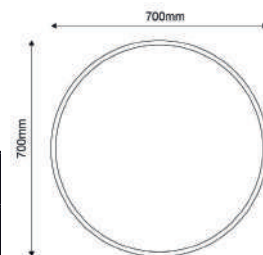

Ø 70

Vokel šifra	Opis	Artikal
<b>1720027</b>	OGLEDALO AURELIA GOLD S LED RASVJETOM	BS-M2231Y

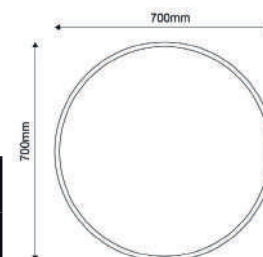

Ø 70

Vokel šifra	Opis	Artikal
<b>1720028</b>	OGLEDALO AURELIA WOOD S LED RASVJETOM	BS-M2231W

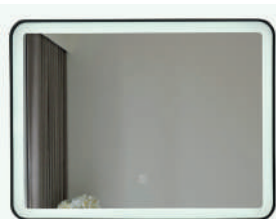
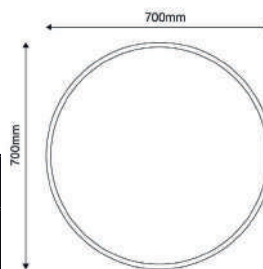

80x60 cm

Vokel šifra	Opis	Artikal
<b>1720003</b>	OGLEDALO NUBE 80x60 S LED RASVJETOM	S-4583

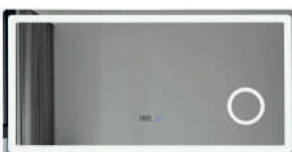
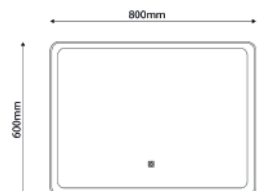

120x60 cm

Vokel šifra	Opis	Artikal
<b>1720004</b>	OGLEDALO LIGERO S POVEĆALOM 3X I LED RASVJETOM	S-3612

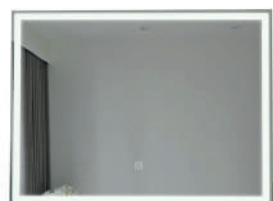
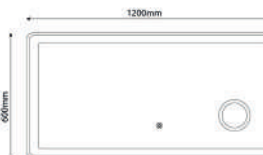

80x60 cm

Vokel šifra	Opis	Artikal
<b>1720005</b>	OGLEDALO VENTO S LED RASVJETOM	S-4635

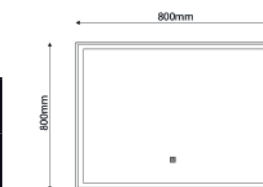



Ø 60

Vokel šifra	Opis	Artikal
<b>1720007</b>	OGLEDALO AMELIE GOLD S LED RASVJETOM	SP-N5817G-60

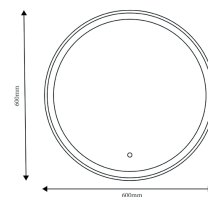

Ø 60

Vokel šifra	Opis	Artikal
<b>1720031</b>	OGLEDALO AMELIE BRONZE S LED RASVJETOM	SP-N58178BR-60

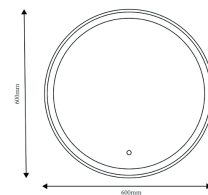

Ø 60

Vokel šifra	Opis	Artikal
<b>1720019</b>	OGLEDALO AMELIE BLACK, S LED RASVJETOM	SP-N5817B-60

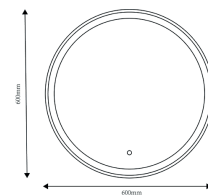

Ø 80

Vokel šifra	Opis	Artikal
<b>1720008</b>	OGLEDALO VIVIEN GOLD S LED RASVJETOM	SP-N5817G-80

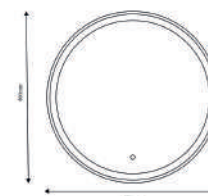

Ø 80

Vokel šifra	Opis	Artikal
<b>1720032</b>	OGLEDALO VIVIEN BRONZE S LED RASVJETOM	SP-N58178BR-80

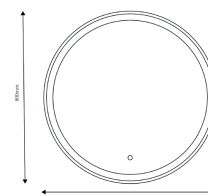

Ø 80

Vokel šifra	Opis	Artikal
<b>1720020</b>	OGLEDALO VIVIEN BLACK, S LED RASVJETOM	SP-N5817B-80

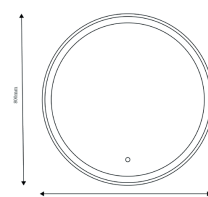





Ø 60

Vokel šifra	Opis	Artikal
<b>1720010</b>	OGLEDALO CAROL S LED RASVJETOM	S-4601-60

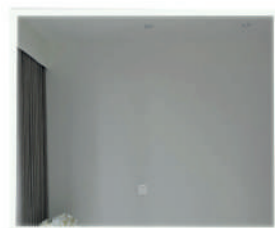
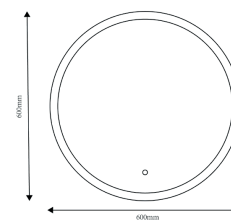

70x70

Vokel šifra	Opis	Artikal
<b>1720011</b>	OGLEDALO KATHERINE S LED RASVJETOM	S-4604

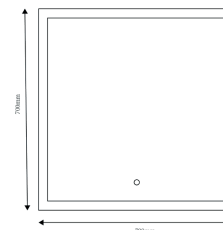

Ø 80

Vokel šifra	Opis	Artikal
<b>1720021</b>	OGLEDALO AMBER, S LED RASVJETOM	S-4601-80

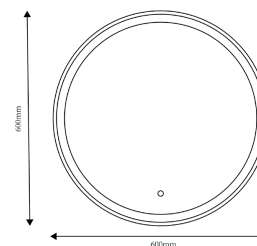

60x100

Vokel šifra	Opis	Artikal
<b>1720022</b>	OGLEDALO NATALIE BLACK S LED RASVJETOM	BS-5001B

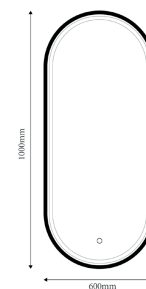

60 x 100

Vokel šifra	Opis	Artikal
<b>1720023</b>	OGLEDALO NATALIE GOLD, S LED RASVJETOM	BS-5001G

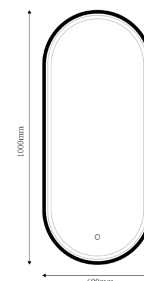



600 x 800

Vokel šifra	Opis	Artikal
<b>1720024</b>	OGLEDALO LILI S LED RASVJETOM	BS-M2235

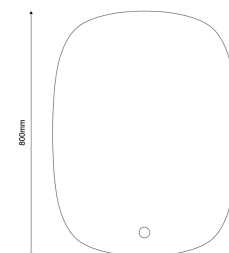

800 x 800

Vokel šifra	Opis	Artikal
<b>1720025</b>	OGLEDALO LILI S LED RASVJETOM	BS-M2236

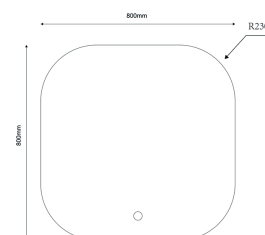

Ø 70

Vokel šifra	Opis	Artikal
<b>1720029</b>	OGLEDALO OLIVIA GOLD S LED RASVJETOM	BS-M2232G

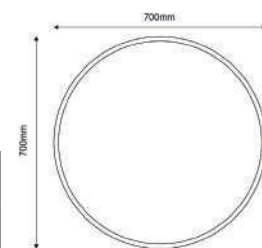

Ø 70

Vokel šifra	Opis	Artikal
<b>1720030</b>	OGLEDALO OLIVIA BLACK S LED RASVJETOM	BS-M2232B

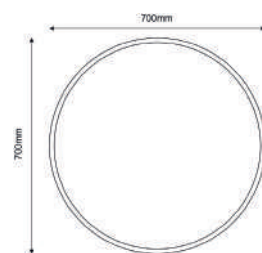

Ø 80

Vokel šifra	Opis	Artikal
<b>1720033</b>	OGLEDALO BIANCA WHITE S LED RASVJETOM	BS-M2250W-80

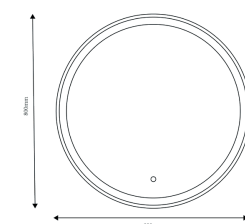



Ø 60

Vokel šifra	Opis	Artikal
<b>1720034</b>	OGLEDALO BIANCA WHITE S LED RASVJETOM	BS-M2250W-60

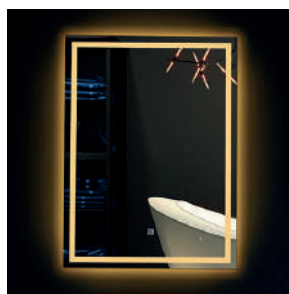
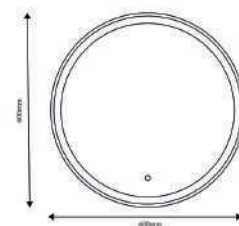

60x80

Vokel šifra	Opis	Artikal
<b>1720041</b>	OGLEDALO HELEN S TOPLOM LED RASVJETOM	BS-M2111



Ø 80

Vokel šifra	Opis	Artikal
<b>1720042</b>	OGLEDALO LORRA S TOPLOM LED RASVJETOM	BS-M2126

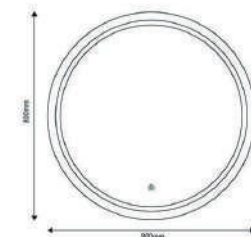

SVJETILJKA LUSI

Vokel šifra	Opis	Artikal
<b>1720018</b>	SVJETILJKA LUSI 42cm	BS-8210



SVJETILJKA LUSI GOLD

Vokel šifra	Opis	Artikal
<b>1720039</b>	SVJETILJKA LUSI GOLD 40 cm	JQ-8210
<b>1720040</b>	SVJETILJKA LUSI GOLD 50 cm	JQ-8210

SVJETILJKA LUMEN BLACK



Vokel šifra	Opis	Artikal
<b>1720037</b>	SVJETILJKA LUMEN BLACK 42 cm	JQ-6610
<b>1720038</b>	SVJETILJKA LUMEN BLACK52 cm	JQ-6610



APURSIL

PRVO ČIŠĆENJE:

Prilikom odstranjivanja zaštitne folije s ogledala, preporučuje se korištenje sredstva Apursil ili nekog sličnog.



DUPLI TOUCH KONTROLER

Vokel šifra	Opis
<b>1720035</b>	LED TRAKA + ODMAGLJIVANJE

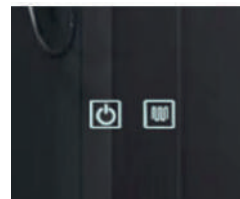

TOUCH KONTROLER

Vokel šifra	Opis
<b>1720036</b>	LED TRAKA

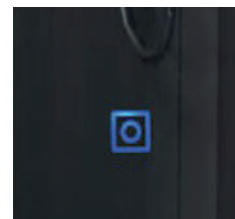



## UMIVAONICI OD PRIRODNOG KAMENA

Svaki umivaonik je unikatan proizvod svojom bojom i strukturom. U procesu proizvodnje koriste se najmoderniji CNC strojevi za obradu kamena te se do krajnjeg izgleda dorađuje ručno. Proizvod je namijenjen za unutarnju upotrebu.

### GARDEN

VOKEL ŠIFRA	OPIS	DIMENZIJA
<b>1721001</b>	UMIVAONIK GARDEN - HERSTONE	40x60 cm



### ROOT

VOKEL ŠIFRA	OPIS	DIMENZIJA
<b>1721002</b>	UMIVAONIK ROOT - HERSTONE	35x50 cm



### HARMONY

VOKEL ŠIFRA	OPIS	DIMENZIJA
<b>1721003</b>	UMIVAONIK HARMONY - HERSTONE	40x40 cm



### BLOOM

VOKEL ŠIFRA	OPIS	DIMENZIJA
<b>1721004</b>	UMIVAONIK BLOOM - HERSTONE	ø 40 cm

# ECOLIGHT PLUS

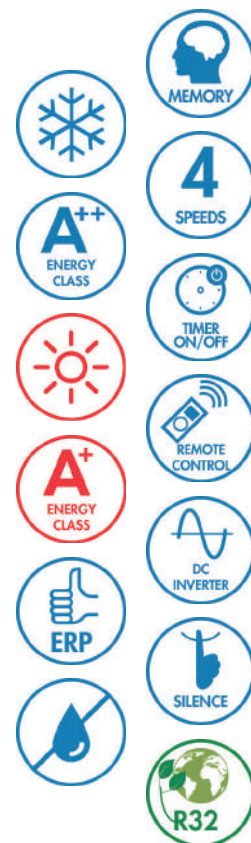

Nizak utjecaj na okoliš, visoka energetska učinkovitost, udobnost i tišina glavni su plusevi ove serije split klima uređaja s istosmjernim inverterom ARGO ECOLIGHT PLUS: idealni za pojedinačnu i višestruku primjenu, kombiniraju maksimalnu udobnost s niskom potrošnjom.

- Hlađenje, grijanje, odvlaživanje i ventilator
- DC Inverter tehnologija, maksimalna udobnost, minimum potrošnja
- Programabilno vrijeme za uključivanje/isključivanje
- R32, ekološki plin s malim utjecajem na globalno zagrijavanje
- 4 brzine ventilatora: Turbo, High, Medium, Low

VOKEL ŠIFRA	OPIS	SNAGA GRIJANJA (kW)	SNAGA HLAĐENJA (kW)	ŠIFRA ARTIKLA
<b>1418121</b>	ECOLIGHT PLUS 9000 - UNUTARNJA JEDINICA	2,8	2,5	398000798
<b>1418122</b>	ECOLIGHT PLUS 9000 - VANJSKA JEDINICA	2,8	2,5	398000799
<b>1418123</b>	ECOLIGHT PLUS 12000 - UNUTARNJA JEDINICA	3,4	3,2	398000800
<b>1418124</b>	ECOLIGHT PLUS 12000 - VANJSKA JEDINICA	3,4	3,2	398000801
<b>1418125</b>	ECOLIGHT PLUS 18000 - UNUTARNJA JEDINICA	5,2	4,6	398000802
<b>1418126</b>	ECOLIGHT PLUS 18000 - VANJSKA JEDINICA	5,2	4,6	398000803
<b>1418127</b>	ECOLIGHT PLUS 24000 - UNUTARNJA JEDINICA	6,5	6,2	398000804
<b>1418128</b>	ECOLIGHT PLUS 24000 - VANJSKA JEDINICA	6,5	6,2	398000805

MODEL		VOKEL ŠIFRA ECOLIGHT PLUS 9		VOKEL ŠIFRA ECOLIGHT PLUS 12	
Unutarnja jedinica		<b>1418121</b> ECOLIGHT PLUS 9000 UI		<b>1418123</b> ECOLIGHT PLUS 12000 UI	
Vanjska jedinica		<b>1418122</b> ECOLIGHT PLUS 9000 UE		<b>1418124</b> ECOLIGHT PLUS 12000 UE	
		Hlađenje	Grijanje	Hlađenje	Grijanje
Kapacitet (nominalni-minimalni-maksimalni) (EN14511)	kW	2,50 (0,50-3,25)	2,80 (0,50-3,50)	3,20 (0,90-2,60)	3,40 (0,90-4,00)
	BTU/h	9000	9000	12000	12000
EER / COP (EN14511)		3,47	3,73	3,23	3,71
Dizajn (Pdesign c / Pdesign h) (prosje/toplo/hladno) (EN14825)	kW	2,5	2,5/2,6/-	3,2	2,7/2,8/-
Omjer učinkovitosti SEER / SCOP (prosje/toplo/hladno) (EN14825)		6,5	4,0/5,1/-	6,1	4,0/5,1/-
Energetski razred		A++	A+/A+++/-	A++	A+/A+++/-
Godišnja potrošnja energije C/H (prosje/toplo/hladno)	kWh/annum	135	875/714/-	184	945/769/-
Unutarnji protok zraka	m <sup>3</sup> /h	500-470-390-270		590-520-400-320	
Odvlaživanje	l/h	0,6		1,4	
Brzina ventilatora (unutarnji/vanjski)	n°	4/1		4/1	
Zvučni pritisak - unutarnji	dB(A)	38-36-32-22		41-37-33-26	
Zvučni pritisak - vanjski	dB(A)	51		51	
Snaga zvuka - unutarnji	dB(A)	55-48-44-34		56-49-45-38	
Snaga zvuka - vanjski	dB(A)	62		64	
Napajanje	V/Ph/Hz	220-240~/1/50		220-240~/1/50	
Snaga izlazne struje	kW	0,720	0,750	0,991	0,916
Model kompresora		Rotary DC Inverter		Rotary DC Inverter	
Vrsta rashladnog sredstva		R32		R32	
Količina rashladnog sredstva	kg/T.CO <sub>2</sub> eq.	0,5/0,338		0,55/0,371	
Promjer cijevi za tekućinu	mm (")	6,35 (1/4")		6,35 (1/4")	
Promjer cijevi za plin	mm (")	9,52 (3/8")		9,52 (3/8")	
Max. duljina cijevi sa standardnim nabojem plina	m	3-5		3-5	
Max. duljina cijevi s dodatnim nabojem	m	15		15	
Dodatna napunjenost rashladnog sredstva	g/m	16		16	
Max. visina između jedinica (Vanjski na vrhu)	m	10		10	
Max. visina između jedinica (Unutarnji na vrhu)	m	10		10	
Neto dimenzija Unutarnja (visina/dužina/dubina)	mm	251/696/190		251/770/190	
Neto dimenzija Vanjska (visina/dužina/dubina)	mm	550/732/330		550/732/330	
Neto težina Unutarnja / Vanjska	kg	7,5/25		8,0/25	

GRANICE RADA (vanjska temperatura):

Hlađenje: +15 °C ~ +43 °C

Grijanje: -15 °C ~ +24 °C

RASPON POSTAVKI UNUTARNJE TEMPERATURE: 16-30 °C

MODEL		VOKEL ŠIFRA ECOLIGHT PLUS 18		VOKEL ŠIFRA ECOLIGHT PLUS 24	
Unutarnja jedinica		<b>1418125</b> ECOLIGHT PLUS 18000 UI		<b>1418127</b> ECOLIGHT PLUS 24000 UI	
Vanjska jedinica		<b>1418126</b> ECOLIGHT PLUS 18000 UE		<b>1418128</b> ECOLIGHT PLUS 24000 UE	
		Hlađenje	Grijanje	Hlađenje	Grijanje
Kapacitet (nominalni-minimalni-maksimalni) (EN14511)	kW	4,60 (1,00-5,30)	5,20 (1,00-5,65)	6,20 (1,60-6,90)	6,50 (1,30-7,90)
	BTU/h	18000	18000	24000	24000
EER / COP (EN14511)		3,40	3,88	3,50	3,95
Dizajn (Pdesign c / Pdesign h) (prosje/toplo/hladno) (EN14825)	kW	4,6	3,7/3,6/-	6,2	4,7/4,7/-
Omjer učinkovitosti SEER / SCOP (prosje/toplo/hladno) (EN14825)		6,4	4,0/5,1/-	6,8	4,0/5,1/-
Energetski razred		A++	A+/A+++/-	A++	A+/A+++/-
Godišnja potrošnja energije C/H (prosje/toplo/hladno)	kWh/annum	251	1295/988/-	319	1290/1645/-
Unutarnji protok zraka	m <sup>3</sup> /h	850-800-700-600		1100-950-750-650	
Odvlaživanje	l/h	1,8		1,8	
Brzina ventilatora (unutarnji/vanjski)	n°	4/1		4/1	
Zvučni pritisak - unutarnji	dB(A)	44-42-38-34		47-44-38-35	
Zvučni pritisak - vanjski	dB(A)	55		58	
Snaga zvuka - unutarnji	dB(A)	54-52-48-44		61-58-52-49	
Snaga zvuka - vanjski	dB(A)	63		67	
Napajanje	V/Ph/Hz	220-240~/1/50		220-240~/1/50	
Snaga izlazne struje	kW	1,355	1,340	1,771	1,646
Model kompresora		Rotary DC Inverter		Rotary DC Inverter	
Vrsta rashladnog sredstva		R32		R32	
Količina rashladnog sredstva	kg/T.CO <sub>2</sub> eq.	0,75/0,506		1,3/0,878	
Promjer cijevi za tekućinu	mm (")	6,35 (1/4")		6,35 (1/4")	
Promjer cijevi za plin	mm (")	9,52 (3/8")		12,7 (1/2")	
Max. duljina cijevi sa standardnim nabojem plina	m	3-5		3-5	
Max. duljina cijevi s dodatnim nabojem	m	25		25	
Dodatna napunjenost rashladnog sredstva	g/m	16		16	
Max. visina između jedinica (Vanjski na vrhu)	m	10		10	
Max. visina između jedinica (Unutarnji na vrhu)	m	10		10	
Neto dimenzija Unutarnja (visina/dužina/dubina)	mm	300/972/225		325/1081/248	
Neto dimenzija Vanjska (visina/dužina/dubina)	mm	550/732/330		555/873/376	
Neto težina Unutarnja / Vanjska	kg	13,5/26,5		16,5/36,5	

GRANICE RADA (vanjska temperatura):

Hlađenje: +15 °C ~ +43 °C

Grijanje: -15°C ~ +24 °C

RASPON POSTAVKI UNUTARNJE TEMPERATURE: 16-30 °C

# X3I ECO PLUS



## WIFI

- Možete kontrolirati udobnost svog doma kada i gdje želite.

## I FEEL FUNKCIJA

- Senzor unutar daljinskog upravljača osjeća temperaturu u okolini i prenosi signal unutarnjoj jedinici. Na taj način unutarnja jedinica može podesiti volumen i temperaturu protoka zraka kako bi pružila udobnost točno na mjestu gdje je daljinski upravljač postavljen.

## SUSTAV ZA PROČIŠĆAVANJE ZRAKA

- Omogućuje učinkovitu sterilizaciju zraka uklanjajući preko 90% bakterija. Uklanja mirise.
- Kvaliteta zraka je poboljšana zahvaljujući emisiji puno negativnih iona kisika.

## INTELIGENTNO AUTOMATSKO PONOVRNO POKRETANJE

- Nakon nestanka struje, jedinica se automatski ponovno pokreće zadržavajući zadnje postavke funkcije. (funkcija memorije)

## LAGANO POKRETANJE

- Potrošnja energije pri pokretanju smanjena je na nižu kako ne bi ometala korištenje drugih uređaja.

VOKEL ŠIFRA	OPIS	SMAGA GRIJANJA (kW)	SNAGA HLAĐENJA (kW)	ŠIFRA ARTIKLA
<b>1418142</b>	X3I ECO PLUS 35 HL WF - UNUTARNJA JEDINICA	3,81	3,51	398000819
<b>1418143</b>	X3I ECO PLUS 35 SH - VANJSKA JEDINICA	3,81	3,51	398000820
<b>1418144</b>	X3I ECO PLUS 52 HL WF - UNUTARNJA JEDINICA	5,6	5,2	398000821
<b>1418145</b>	X3I ECO PLUS 52 SH - VANJSKA JEDINICA	5,6	5,2	398000822
<b>1418146</b>	X3I ECO PLUS 70 HL WF - UNUTARNJA JEDINICA	7,8	7,1	398000823
<b>1418147</b>	X3I ECO PLUS 70 SH - VANJSKA JEDINICA	7,8	7,1	398000824



MODEL		VOKEL ŠIFRA X3I ECO PLUS 35		VOKEL ŠIFRA X3I ECO PLUS 52	
Unutarnja jedinica		<b>1418142</b> X3I ECO PLUS 35 HL WF		<b>1418144</b> X3I ECO PLUS 52 HL WF	
Vanjska jedinica		<b>1418143</b> X3I ECO PLUS 35 SH		<b>1418145</b> X3I ECO PLUS 52 SH	
		Hlađenje	Grijanje	Hlađenje	Grijanje
Kapacitet (nominalni-minimalni-maksimalni) (EN14511)	kW	3,51 (0,90-4,40)	3,81 (0,90-4,70)	5,20 (1,00-6,10)	5,60(1,10-6,60)
	BTU/h	12000	1300	17800	19100
EER / COP (EN14511)		3,65	4,00	3,30	3,90
Dizajn (Pdesign c / Pdesign h) (prosje/toplo/hladno) (EN14825)	kW	3,5	3,2/3,3/4,5	5,2	4,2/4,3/5,0
Omjer učinkovitosti SEER / SCOP (prosje/toplo/hladno) (EN14825)		7,1	4,1/5,2/3,1	7,1	4,2/5,7/3,4
Energetski razred		A++	A+/A+++/B	A++	A+/A+++/A
Godišnja potrošnja energije C/H (prosje/toplo/hladno)	kWh/annum	173	1093/888/3048	256	1400/1056/3088
Unutarnji protok zraka	m <sup>3</sup> /h	700-650-600-540-480-420-360		800-750-680-610-570-520-460	
Odvlaživanje	l/h	1,4		1,9	
Brzina ventilatora (unutarnji/vanjski)	n°	7/2		7/2	
Zvučni pritisak - unutarnji	dB(A)	42-38-35-32-29-26-25		44-43-41-38-36-34-30	
Zvučni pritisak - vanjski	dB(A)	52		56	
Snaga zvuka - unutarnji	dB(A)	57-50-47-44-41-38-37		60-56-54-51-49-47-43	
Snaga zvuka - vanjski	dB(A)	63		65	
Napajanje	V/Ph/Hz	220-240V~/1/50		220-240V~/0/1/50	
Snaga izlazne struje	kW	0,962 (0,22-1,40)	0,953 (0,22-1,55)	1,576 (0,10-2,35)	1,436 (0,18-2,40)
Model kompresora		Rotary DC Inverter		Rotary DC Inverter	
Vrsta rashladnog sredstva		R32		R32/675	
Količina rashladnog sredstva	kg/T.CO <sub>2</sub> eq.	0,57/0,384		0,82/0,553	
Promjer cijevi za tekućinu	mm (")	6,35 (1/4")		6,35 (1/4")	
Promjer cijevi za plin	mm (")	9,52 (3/8")		12,7 (1/2")	
Max. duljina cijevi sa standardnim nabojem plina	m	3-5		3-5	
Max. duljina cijevi s dodatnim nabojem	m	15		25	
Dodatna napunjenost rashladnog sredstva	g/m	16		16	
Max. visina između jedinica (Vanjski na vrhu)	m	10		10	
Max. visina između jedinica (Unutarnji na vrhu)	m	10		10	
Neto dimenzija Unutarnja (visina/dužina/dubina)	mm	289/845/209		300/970/224	
Neto dimenzija Vanjska (visina/dužina/dubina)	mm	555/732/330		555/802/350	
Neto težina Unutarnja / Vanjska	kg	11/24,5		13/30,5	

GRANICE RADA (vanjska temperatura):

Hlađenje: -15 °C ~ +43 °C

Grijanje: -15°C ~ +24 °C

RASPON POSTAVKI UNUTARNJE TEMPERATURE: 16-30 °C

MODEL		VOKEL ŠIFRA X3I ECO PLUS 70	
Unutarnja jedinica		<b>1418146</b> X3I ECO PLUS 70 HL WF	
Vanjska jedinica		<b>1418147</b> X3I ECO PLUS 70 SH	
		Hlađenje	Grijanje
Kapacitet (nominalni-minimalni-maksimalni) (EN14511)	kW	7,10 (2,00-8,85)	7,80 (1,80-9,45)
	BTU/h	24200	26600
EER / COP (EN14511)		3,50	3,90
Dizajn (Pdesign c / Pdesign h) (prosje/toplo/hladno) (EN14825)	kW	7,1	5,6/5,7/6,3
Omjer učinkovitosti SEER / SCOP (prosje/toplo/hladno) (EN14825)		7,00	4,2/5,4/3,4
Energetski razred		A++	A+/A+++/A
Godišnja potrošnja energije C/H (prosje/toplo/hladno)	kWh/annum	355	1867/1478/3891
Unutarnji protok zraka	m <sup>3</sup> /h	1250-1100-1000-950-900-850-800	
Odvlaživanje	l/h	2,4	
Brzina ventilatora (unutarnji/vanjski)	n°	7/2	
Zvučni pritisak - unutarnji	dB(A)	48-44-41-40-38-36-33	
Zvučni pritisak - vanjski	dB(A)	59	
Snaga zvuka - unutarnji	dB(A)	64-59-56-55-53-51-48	
Snaga zvuka - vanjski	dB(A)	70	
Napajanje	V/Ph/Hz	220-240V~/1/50	
Snaga izlazne struje	kW	2,030 (0,45-2,90)	2,000 (0,35-3,00)
Model kompresora		Rotary DC Inverter	
Vrsta rashladnog sredstva		R32/675	
Količina rashladnog sredstva	kg/T.CO <sub>2</sub> eq.	1,5/1,0125	
Promjer cijevi za tekućinu	mm (")	6,35 (1/4")	
Promjer cijevi za plin	mm (")	15,88 (5/8")	
Max. duljina cijevi sa standardnim nabojem plina	m	3-5	
Max. duljina cijevi s dodatnim nabojem	m	25	
Dodatna napunjenost rashladnog sredstva	g/m	40	
Max. visina između jedinica (Vanjski na vrhu)	m	10	
Max. visina između jedinica (Unutarnji na vrhu)	m	10	
Neto dimenzija Unutarnja (visina/dužina/dubina)	mm	325/1078/246	
Neto dimenzija Vanjska (visina/dužina/dubina)	mm	660/958/402	
Neto težina Unutarnja / Vanjska	kg	16/41,5	

GRANICE RADA (vanjska temperatura):

Hlađenje: -15 °C ~ +43 °C

Grijanje: -15 °C ~ +24 °C

RASPON POSTAVKI UNUTARNJE TEMPERATURE: 16-30 °C

# X3I ECO PLUS PODNA



Infracrveni daljinski upravljač



Žičani upravljač sa tjednim mjeracem vremena

- A ++ Hlađenje
- A + Grijanje (prosječna sezona)
- A +++ Grijanje (toplija sezona)



## WIFI

- Možete kontrolirati udobnost svog doma kada i gdje želite.

## I FEEL FUNKCIJA

- Senzor unutar daljinskog upravljača osjeća temperaturu u okolini i prenosi signal unutarnjoj jedinici. Na taj način unutarnja jedinica može podesiti volumen i temperaturu protoka zraka kako bi pružila udobnost točno na mjestu gdje je daljinski upravljač postavljen.

## SUSTAV ZA PROČIŠĆAVANJE ZRAKA

- Omogućuje učinkovitu sterilizaciju zraka uklanjajući preko 90% bakterija. Uklanja mirise.
- Kvaliteta zraka je poboljšana zahvaljujući emisiji puno negativnih iona kisika.

## TANAK I ELEGANTAN DIZAJN

- Konzola se savršeno integrira s bilo kojom vrstom namještaja, zahvaljujući svom čistom, tankom i elegantnom dizajnu.

## GRANICA RADA GRIJANJA SMANJENA NA VRLO NISKE VANJSKE TEMPERATURE

- Može raditi u načinu grijanja čak i pri niskim vanjskim temperaturama, do -22°C, stoga je prikladan za oštre klimatske uvjete.

VOKEL ŠIFRA	OPIS	SMAGA GRIJANJA (kW)	SNAGA HLAĐENJA (kW)	ŠIFRA ARTIKLA
<b>1418092</b>	X3I ECO AF27HL PODNA - UNUTARNJA JEDINICA	2,8	2,7	398000669
<b>1418162</b>	X3I ECO PLUS 27 SH LHB - VANJSKA JEDINICA	2,8	2,7	398000740
<b>1418082</b>	X3I ECO PLUS AF35 HL PODNA- UNUTARNJA JEDINICA	3,8	3,52	398000741
<b>1418083</b>	X3I ECO PLUS 35 SH LHB - VANJSKA JEDINICA	3,8	3,52	398000742
<b>1418084</b>	X3I ECO PLUS AF52 HL PODNA- UNUTARNJA JEDINICA	5,33	5,2	398000743
<b>1418085</b>	X3I ECO PLUS 52SH LHB - VANJSKA JEDINICA	5,33	5,2	398000744

MODEL		PODNA X3I ECO AF27HL	
Unutarnja jedinica		<b>VOKEL ŠIFRA 1418092</b>	
Vanjska jedinica		<b>VOKEL ŠIFRA 1418162</b>	
		Hlađenje	Grijanje
Kapacitet (nominalni-minimalni-maksimalni) (EN14511)	kW	2,7 (0,7-3,4)	2,9 (0,6-3,5)
	BTU/h	9200	10000
EER / COP (EN14511)		3,75	3,97
Dizajn (Pdesign c / Pdesign h) (prosje/toplo/hladno) (EN14825)	kW	2,7	2,6/2,8/-
Omjer učinkovitosti SEER / SCOP (prosje/toplo/hladno) (EN14825)		7,20	4,0/5,3/-
Energetski razred		A++	A+/A+++/-
Godišnja potrošnja energije C/H (prosje/toplo/hladno)	kWh/annum	131	910/740
Unutarnji protok zraka	m <sup>3</sup> /h	500-430-410-370-330-280-250	
Odvlaživanje	l/h	0,8	
Brzina ventilatora (unutarnji/vanjski)	n°	7/2	
Zvučni pritisak - unutarnji	dB(A)	39-36-33-31-29-26-23	
Zvučni pritisak - vanjski	dB(A)	49	
Snaga zvuka - unutarnji	dB(A)	50-48-45-44-42-38-34	
Snaga zvuka - vanjski	dB(A)	60	
Napajanje	V/Ph/Hz	220-240~/1/50	
Snaga izlazne struje	kW	0,72 (0,17-1,3)	0,73 (0,13-1,35)
Model kompresora		Rotary DC Inverter	
Vrsta rashladnog sredstva		R32/675	
Količina rashladnog sredstva	kg/T.CO <sub>2</sub> eq.	0,55/0,37	
Promjer cijevi za tekućinu	mm (")	6,35 (1/4")	
Promjer cijevi za plin	mm (")	9,52 (3/8")	
Max. duljina cijevi sa standardnim nabojem plina	m	3-5	
Max. duljina cijevi s dodatnim nabojem	m	15	
Dodatna napunjenost rashladnog sredstva	g/m	16	
Max. visina između jedinica (Vanjski na vrhu)	m	10	
Max. visina između jedinica (Unutarnji na vrhu)	m	10	
Neto dimenzija Unutarnja (visina/dužina/dubina)	mm	600/700/215	
Neto dimenzija Vanjska (visina/dužina/dubina)	mm	540/782/320	
Neto težina Unutarnja / Vanjska	kg	15,5/27,5	

GRANICE RADA (vanjska temperatura):

Hlađenje: -15 °C ~ +43 °C

Grijanje: -22°C ~ +24 °C

RASPON POSTAVKI UNUTARNJE TEMPERATURE: 16-30 °C

MODEL		VOKEL ŠIFRA X3I ECO PLUS 35		VOKEL ŠIFRA X3I ECO PLUS 52	
Unutarnja jedinica		<b>1418082</b> X3I ECO PLUS AF35 HL		<b>1418084</b> X3I ECO PLUS AF52 HL	
Vanjska jedinica		<b>1418083</b> X3I ECO PLUS 35 SH LHB		<b>1418085</b> X3I ECO PLUS 52 SH LHB	
		Hlađenje	Grijanje	Hlađenje	Grijanje
Kapacitet (nominalni-minimalni-maksimalni) (EN14511)	kW	3,52 (0,8-4,4)	3,8 (1,1-4,4)	5,2 (1,26-6,6)	5,33 (1,12-6,8)
	BTU/h	12000	13000	17800	18000
EER / COP (EN14511)		3,52	3,96	3,40	3,55
Dizajn (Pdesign c / Pdesign h) (prosje/toplo/hladno) (EN14825)	kW	3,5	3,20/3,30/-	5,2	5,0/5,2/-
Omjer učinkovitosti SEER / SCOP (prosje/toplo/hladno) (EN14825)		7,0	4,10/5,30/-	6,6	4,1/5,1/-
Energetski razred		A++	A+/A+++/-	A++	A+/A+++/-
Godišnja potrošnja energije C/H (prosje/toplo/hladno)	kWh/annum	175	1050/961/2953	260	1707/1427/-
Unutarnji protok zraka	m <sup>3</sup> /h	600-520-480-440-400-360-280		700-650-580-520-460-410-320	
Odvlaživanje	l/h	1,2		1,8	
Brzina ventilatora (unutarnji/vanjski)	n°	7/2		7/2	
Zvučni pritisak - unutarnji	dB(A)	44-40-38-36-33-29-25		47-45-42-40-37-35-31	
Zvučni pritisak - vanjski	dB(A)	52		57	
Snaga zvuka - unutarnji	dB(A)	54-50-48-46-43-39-35		57-55-52-50-47-45-41	
Snaga zvuka - vanjski	dB(A)	62		65	
Napajanje	V/Ph/Hz	220-240~/1/50		220-240~/1/50	
Snaga izlazne struje	kW	1,00 (0,16-1,5)	0,960 (0,165-1,5)	1,55 (0,38-2,45)	1,5 (0,35-2,5)
Model kompresora		Rotary DC Inverter		Rotary DC Inverter	
Vrsta rashladnog sredstva		R32/675		R32/675	
Količina rashladnog sredstva	kg/T.CO <sub>2</sub> eq.	0,75/0,51		0,95/0,64	
Promjer cijevi za tekućinu	mm (")	6,35 (1/4")		6,35 (1/4")	
Promjer cijevi za plin	mm (")	9,52 (3/8")		12,7 (1/2")	
Max. duljina cijevi sa standardnim nabojem plina	m	3-5		3-5	
Max. duljina cijevi s dodatnim nabojem	m	20		25	
Dodatna napunjenost rashladnog sredstva	g/m	16		20	
Max. visina između jedinica (Vanjski na vrhu)	m	10		10	
Max. visina između jedinica (Unutarnji na vrhu)	m	10		10	
Neto dimenzija Unutarnja (visina/dužina/dubina)	mm	600/700/215		600/700/215	
Neto dimenzija Vanjska (visina/dužina/dubina)	mm	596/848/320		700/965/396	
Neto težina Unutarnja / Vanjska	kg	15,5/30,5		15,5/46	

GRANICE RADA (vanjska temperatura):

Hlađenje: -15 °C ~ +43 °C

Grijanje: -22°C ~ +24 °C

RASPON POSTAVKI UNUTARNJE TEMPERATURE: 16-30 °C



MODEL		DUAL X3MI ECO 18 DCI R32		TRIAL X3MI ECO 21 DCI R32	
		VOKEL ŠIFRA 1418086		VOKEL ŠIFRA 1418087	
Vanjska jedinica					
		Hlađenje	Grijanje	Hlađenje	Grijanje
Kapacitet (nominalni-minimalni-maksimalni) (EN14511)	kW	5,30 (2,14-5,80)	5,65 (2,58-6,50)	6,10 (2,20-8,30)	6,50 (3,60-8,50)
	BTU/h	18000	19300	20800	22200
EER / COP (EN14511)		3,58	4,53	4,12	4,56
Dizajn (Pdesign c / Pdesign h) (prosje/toplo/hladno) (EN14825)	kW	5,3	4,3	6,1	6,1
Omjer učinkovitosti SEER / SCOP (prosje/toplo/hladno) (EN14825)		6,6	4,0	6,1	4,0
Energetski razred		A++	A+	A++	A+
Godišnja potrošnja energije C/H (prosje/toplo/hladno)	kWh/annum	281	1505	350	2135
Min./Max. broj spojivih unutarnjih jedinica	br.	2		2-3	
Brzina protoka zraka	m <sup>3</sup> /h	2300		3800	
Brzina ventilatora - vanjski	n°	2		2	
Zvučni pritisak - vanjski	dB(A)	50	54	57	58
Snaga zvuka - vanjski	dB(A)	64		68	
Napajanje	V/Ph/Hz	220-240~/1/50		220-240~/1/50	
Snaga izlazne struje nominalna (min. - max.)	kW	1,48 (0,56-1,56)	1,25 (0,78-1,78)	1,48 (0,95-2,39)	1,43 (0,78-2,87)
Model kompresora		Rotary DC Inverter		Rotary DC Inverter	
Vrsta rashladnog sredstva		R32/675		R32/675	
Količina rashladnog sredstva	kg/T.CO <sub>2</sub> eq.	0,90/0,608		1,6/1,080	
Promjer cijevi za tekućinu	mm (")	6,35 (1/4")		6,35 (1/4")	
Promjer cijevi za plin	mm (")	9,52 (3/8")		9,52 (3/8")	
Min./Max. duljina cijevi sa standardnim nabojem plina	m	3-10		3-30	
Max. duljina cijevi s dodatnim nabojem	m	40		60	
Max duljina cijevi za jedinicu	m	20		20	
Dodatna napunjenost rashladnog sredstva	g/m	20		20	
Max. visina između jedinica (Unutarnji na vrhu)	m	15		15	
Neto dimenzija Vanjska (visina/dužina/dubina)	mm	550/745/300		654/889/340	
Neto težina	kg	30		47,5	

GRANICE RADA (vanjska temperatura):

Hlađenje: -15 °C ~ +43 °C

Grijanje: -15°C ~ +24 °C

RASPON POSTAVKI UNUTARNJE TEMPERATURE: 16-30 °C

# X3MI ECO



## NEKOLIKO OPCIJA

- Mogućnost izbora između različitih kapaciteta i tipova unutarnjih jedinica.

## ŠIROK RASPON

- Raspon kapaciteta od 18 do 4200 BTU/h
- Široko se koristi u stambenim kućama, hotelima, poslovnim uredima

## DC INVERTERSKA TEHNOLOGIJA

- Niska potrošnja
- Niska razina buke
- Precizna kontrola temperature

## NISKO AMBIJENTALNO HLAĐENJE I GRIJANJE

- Sposobnost rada do -15 °C vanjske temperature. U načinu hlađenja i grijanja, osigurava visoku pouzdanost proizvoda: kada se vanjska temperatura promijeni, frekvencija kompresora i brzina ventilatora se prilagođavaju u skladu s tim.

VOKEL ŠIFRA	OPIS	SMAGA GRIJANJA (kW)	SNAGA HLAĐENJA (kW)	ŠIFRA ARTIKLA
<b>1418086</b>	DUAL X3MI ECO 52SH - VANJSKA JEDINICA	5,4	5,2	398000792
<b>1418087</b>	TRIAL X3MI ECO 61SH - VANJSKA JEDINICA	6,5	6,1	398000793
<b>1418088</b>	TRIAL X3MI ECO 71SH - VANJSKA JEDINICA	8,5	7,1	398000794
<b>1418089</b>	QUADRI X3MI ECO 80SH - VANJSKA JEDINICA	9,5	8,0	398000795
<b>1418090</b>	QUADRI X3MI ECO 105SH - VANJSKA JEDINICA	11	10,5	398000796
<b>1418091</b>	PENTA X3MI ECO 120SH - VANJSKA JEDINICA	13	12	398000797

MODEL		TRIAL X3MI ECO 24 DCI R32		QUADRI X3MI ECO 28 DCI R32	
		VOKEL ŠIFRA 1418088		VOKEL ŠIFRA 1418089	
Vanjska jedinica		Hlađenje	Grijanje	Hlađenje	Grijanje
Kapacitet (nominalni-minimalni-maksimalni) (EN14511)	kW	7,10 (2,30-9,20)	8,60(3,65-9,20)	8,0 (2,30-11,0)	9,50 (3,65-10,25)
	BTU/h	24200	29300	28000	32400
EER / COP (EN14511)		3,77	3,86	3,77	4,31
Dizajn (Pdesign c / Pdesign h) (prosje/toplo/hladno) (EN14825)	kW	7,1	6,1	8,0	7,2
Omjer učinkovitosti SEER / SCOP (prosje/toplo/hladno) (EN14825)		6,1	4,0	6,1	4,0
Energetski razred		A++	A+	A++	A+
Godišnja potrošnja energije C/H (prosje/toplo/hladno)	kWh/annum	407	2189	459	2520
Min./Max. broj spojivih unutarnjih jedinica	br.	2-3		2-4	
Brzina protoka zraka	m <sup>3</sup> /h	3800		3800	
Brzina ventilatora - vanjski	n°	2		2	
Zvučni pritisak - vanjski	dB(A)	57	58	58	
Snaga zvuka - vanjski	dB(A)	68		68	
Napajanje	V/Ph/Hz	220-240~/1/50		220-240~/1/50	
Snaga izlazne struje nominalna (min. - max.)	kW	1,88 (1,10-2,87)	2,23 (0,98-2,87)	2,12 (1,30-3,58)	2,20 (1,0-2,87)
Model kompresora		Rotary DC Inverter		Rotary DC Inverter	
Vrsta rashladnog sredstva		R32/675		R32/675	
Količina rashladnog sredstva	kg/T.CO <sub>2</sub> eq.	1,7/1,148		1,8/1,215	
Promjer cijevi za tekućinu	mm (")	6,35 (1/4")		6,35 (1/4")	
Promjer cijevi za plin	mm (")	9,52 (3/8")		9,52 (3/8")	
Min./Max. duljina cijevi sa standardnim nabojem plina	m	3-30		3-40	
Max. duljina cijevi s dodatnim nabojem	m	60		70	
Max duljina cijevi za jedinicu	m	20		20	
Dodatna napunjenost rashladnog sredstva	g/m	20		20	
Max. visina između jedinica (Unutarnji na vrhu)	m	15		15	
Neto dimenzija Vanjska (visina/dužina/dubina)	mm	654/889/340		654/889/340	
Neto težina	kg	47,5		51	

GRANICE RADA (vanjska temperatura):

Hlađenje: -15 °C ~ +43 °C

Grijanje: -15°C ~ +24 °C

RASPON POSTAVKI UNUTARNJE TEMPERATURE: 16-30 °C

MODEL		QUADRI X3MI ECO 36 DCI R32		PENTA X3MI ECO 42 DCI R32	
		VOKEL ŠIFRA 1418090		VOKEL ŠIFRA 1418091	
Vanjska jedinica					
		Hlađenje	Grijanje	Hlađenje	Grijanje
Kapacitet (nominalni-minimalni-maksimalni) (EN14511)	kW	10,60 (2,60-12,00)	12,00 (3,00-14,00)	12,10(2,60-15,20)	13,00 (3,00-15,50)
	BTU/h	36200	40900	41300	44400
EER / COP (EN14511)		3,53	3,95	3,56	4,08
Dizajn (Pdesign c / Pdesign h) (prosje/toplo/hladno) (EN14825)	kW	10,6	10,5	12,10	13,00
Omjer učinkovitosti SEER / SCOP (prosje/toplo/hladno) (EN14825)		7,2	4,0	6,1	4,0
Energetski razred		A++	A+	A++	A+
Godišnja potrošnja energije C/H (prosje/toplo/hladno)	kWh/annum	515	3675	689	4130
Min./Max. broj spojivih unutarnjih jedinica	br.	2-4		2-5	
Brzina protoka zraka	m <sup>3</sup> /h	5800		5800	
Brzina ventilatora - vanjski	n°	2		2	
Zvučni pritisak - vanjski	dB(A)	60		60	
Snaga zvuka - vanjski	dB(A)	70		72	74
Napajanje	V/Ph/Hz	220-240~/1/50		220-240~/1/50	
Snaga izlazne struje nominalna (min. - max.)	kW	3,00	3,04	3,40	3,19
Model kompresora		Rotary DC Inverter		Rotary DC Inverter	
Vrsta rashladnog sredstva		R32/675		R32/675	
Količina rashladnog sredstva	kg/T.CO <sub>2</sub> eq.	2,40/1,62		2,40/1,62	
Promjer cijevi za tekućinu	mm (")	6,35 (1/4")		6,35 (1/4")	
Promjer cijevi za plin	mm (")	9,52 (3/8")		9,52 (3/8")	
Min./Max. duljina cijevi sa standardnim nabojem plina	m	3-40		3-50	
Max. duljina cijevi s dodatnim nabojem	m	80		100	
Max duljina cijevi za jedinicu	m	25		25	
Dodatna napunjenost rashladnog sredstva	g/m	20		20	
Max. visina između jedinica (Vanjski na vrhu)	m	25		25	
Max. visina između jedinica (Unutarnji na vrhu)	m	15		25	
Neto dimenzija Vanjska (visina/dužina/dubina)	mm	826/1020/427		826/1020/427	
Neto težina	kg	72		73	

GRANICE RADA (vanjska temperatura):

Hlađenje: -15 °C ~ +43 °C

Grijanje: -15°C ~ +24 °C

RASPON POSTAVKI UNUTARNJE TEMPERATURE: 16-30 °C

# X3I ECO KAZETNA - za multi sistem



Infracrveni daljinski upravljač



Žičani upravljač s wifijem



Žičani upravljač sa tjednim mjeracem vremena



VOKEL ŠIFRA	OPIS	ŠIFRA ARTIKLA
<b>1418155</b>	MASKA KAZETNE JEDINICE	398100688
<b>1418158</b>	MASKA KAZETNE JEDINICE - VELIKA	398100677

MODEL		KAZETNA JEDINICA X3I ECO AS35HL		KAZETNA JEDINICA X3I ECO AS850HL	
		VOKEL ŠIFRA 1418176		VOKEL ŠIFRA 1418177	
Unutarnja jedinica		Hlađenje	Grijanje	Hlađenje	Grijanje
Kapacitet	kW	3,5	4,0	5,0	5,50
Brzina protoka zraka	m <sup>3</sup> /h	560-540-490-450-420-380-350		650-540-490-450-420-380-350	
Odvlaživanje	l/h	1,8		1,8	
Brzina ventilatora	n°	7+auto		7+auto	
Zvučni pritisak	dB(A)	41-39-36-34-32-30-28		43-39-36-34-32-30-28	
Snaga zvuka	dB(A)	57-55-52-50-48-46-44		59-55-52-50-48-46-44	
Promjer cijevi za tekućinu	mm (inch")	6,35 (1/4")		6,35 (1/4")	
Promjer cijevi za plin	mm (inch")	9,52 (3/8")		12,7 (1/2")	
Neto dimenzija bez panela (visina/dužina/dubina)	mm	265/570/570		265/570/570	
Neto dimenzija panela (visina/dužina/dubina)	mm	312,5/620/620		312,5/620/620	
Neto dimenzija (visina/dužina/dubina)	mm	47,5/620/620		47,5/620/620	
Neto težina bez panela	kg	17		17	
Neto težina panela	kg	3		3	



MODEL		KAZETNA JEDINICA X3I ECO AS28HL		KAZETNA JEDINICA X3I ECO AS70HL	
		Hlađenje	Grijanje	Hlađenje	Grijanje
Kapacitet	kW	2,80	2,90	7,0	8,0
Brzina protoka zraka	m <sup>3</sup> /h	560-540-490-450-420-380-350		1100-1050-950-910-870-830-800	
Odvlaživanje	l/h	1,4		2,5	
Brzina ventilatora	n°	7+auto		7+auto	
Zvučni pritisak	dB(A)	41-39-36-34-32-30-28		46-45-44-43-42-41-39	
Snaga zvuka	dB(A)	57-55-52-50-48-46-44		62-61-60-59-58-57-55	
Promjer cijevi za tekućinu	mm (inch")	6,35 (1/4")		6,35 (1/4")	
Promjer cijevi za plin	mm (inch")	9,52 (3/8")		15,88 (5/8")	
Neto dimenzija bez panela (visina/dužina/dubina)	mm	265/570/570		240/840/840	
Neto dimenzija panela (visina/dužina/dubina)	mm	312,5/620/620		292/950/950	
Neto dimenzija	mm	47,5/620/620		52/950/950	
Neto težina bez panela	kg	17		29	
Neto težina panela	kg	3		6	

Navedeni modeli su dostupni po narudžbi.\*\*

# X3I ECO KANALNA- za multi sistem

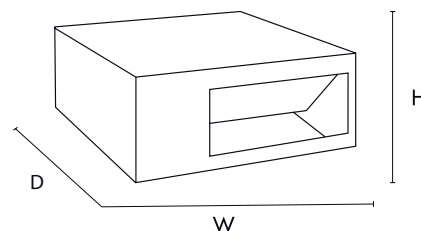

MODEL		KANALNA JEDINICA X3I ECO SD35HL		KANALNA JEDINICA X3I ECO SD50HL	
		VOKEL ŠIFRA 1418148		VOKEL ŠIFRA 1418149	
		Hlađenje	Grijanje	Hlađenje	Grijanje
Kapacitet	kW	3,50	3,85	5,0	5,50
Brzina protoka zraka	m <sup>3</sup> /h	700-670-640-610-580-550-520		880-840-810-790-770-750-730	
Min-max vanjski statični pritisak	Pa	25-60		25-60	
Odvlaživanje	l/h	1,4		1,8	
Brzina ventilatora	n°	7+auto		7+auto	
Zvučni pritisak	dB(A)	41-39-38-37-36-35-34		41-39-39-38-38-37-34	
Snaga zvuka	dB(A)	57-55-54-53-52-51-50		57-55-55-54-54-53-50	
Promjer cijevi za tekućinu	mm (inch")	6,35 (1/4")		6,35 (1/4")	
Promjer cijevi za plin	mm (inch")	9,52 (3/8")		12,7 (1/2")	
Neto dimenzija (visina/dužina/dubina)	mm	200/710/450		200/1010/450	
Neto težina	kg	19		25	

MODEL		KANALNA JEDINICA X3I ECO SD27HL		KANALNA JEDINICA X3I ECO SD70HL	
		Hlađenje	Grijanje	Hlađenje	Grijanje
Kapacitet	kW	2,65	2,80	7,00	8,00
Brzina protoka zraka	m <sup>3</sup> /h	650-560-520-480-450-410-380		1500-1200-1200-1000-1000-900-900	
Min-max vanjski statični pritisak	Pa	25-60		25-125	
Odvlaživanje	l/h	0,8		2,5	
Brzina ventilatora	n°	7+auto		7+auto	
Zvučni pritisak	dB(A)	39-37-36-35-34-33-32		45-40-40-38-38-36-36	
Snaga zvuka	dB(A)	55-53-52-51-50-49-48		62-57-57-55-55-53-53	
Promjer cijevi za tekućinu	mm (inch")	6,35 (1/4")		6,35 (1/4")	
Promjer cijevi za plin	mm (inch")	9,52 (3/8")		15,88 (1/2")	
Neto dimenzija (visina/dužina/dubina)	mm	200/710/450		260/900/655	
Neto težina	kg	18,5		31	

Navedeni modeli su dostupni po narudžbi.\*\*

# HEATER KALORIFERI

HEATER toplovodni grijači su jedan u nizu modernih i pouzdanih uređaja proizvedenih da griju zgrade sa velikim kapacitetom

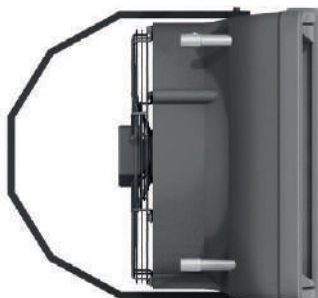

**3 BRZINSKI VENTILATOR**  
kao standardna ponuda

## KALORIFER - S TROBRZINSKIM VENTILATOROM CR1, CR2, CR3

- \* visina  $\Delta T$  ispušnog zraka
- \* maksimalna upotreba površine izmjenjivača
- \* visoka učinkovitost na svakoj brzini

ŠIFRA VOKEL	OPIS	SNAGA	ŠIFRA ARTIKLA
<b>1447021</b>	KAROLIFER CR1	9-30kW	WA0016+WAA0028(konzola)
<b>1447022</b>	KAROLIFER CR2	13-50kW	WA0017+WAA0028(konzola)
<b>1447023</b>	KAROLIFER CR3	20-70kW	WA0018+WAA0028(konzola)

## INSTALACIJA UREĐAJA

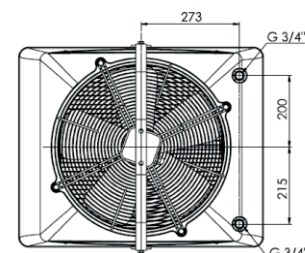
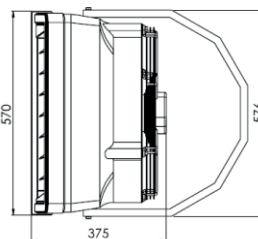
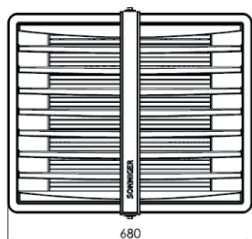
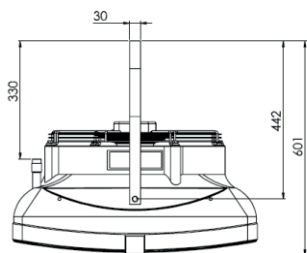
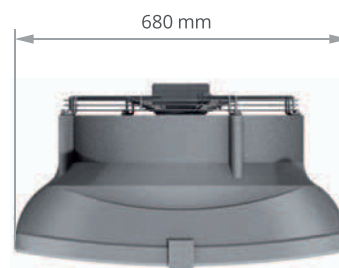
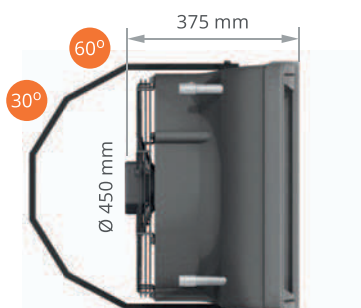
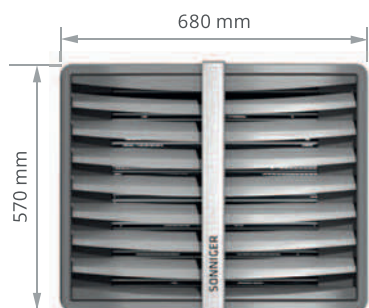
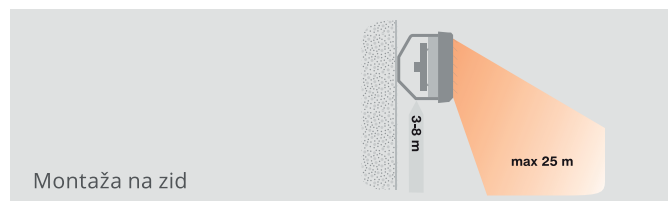

### HEATER CONDENS series

TEHNIČKI PODACI		CR ONE	CR1	CR2	CR3	CR3 MAX	CR4 MAX	MIX 1
raspon toplinske snage *	kW	7-20	9-30	13-50	20-70	33-90	45-120	-
izlaz topline (70/50°C)/ΔT porast temperature zraka **	kW/°C	13/25	16/14	26/22	35/34	53/28	72/42	-
broj jedinica		2	1	2	3	3	4	-
izlaz zraka - III brzina	m <sup>3</sup> /h	1600	3900	3350	2950	5250	4650	4800
nivo zvuka na 5m udaljenosti - III brzina	dB	52	62	60	58	65	65	54
promjer priključnih mlaznica	inches	1/2"	3/4"	3/4"	3/4"	1"	1"	-
parametri napajanja V/Hz 230/50	W/A	124/0,58	240/1,08		520/2,2		240/1,08	

\* maksimalan izlaz topline naznačen za temperaturu vodenog sredstva 120/90°C i temperaturu ulaza zraka 0°C, III brzina/minimalan izlaz topline naznačen za 50/30°C i temperatura ulaza zraka 0°C, III brzina  
 \*\* za temperaturu ulaza zraka 0°C

### HEATER CONDENS CR1

ulaz/izlaz temperature vode temperatura ulaznog zraka	50/30				50/40				60/40				70/50				80/60				90/70				120/90									
	0	5	10	15	20	0	5	10	15	20	0	5	10	15	20	0	5	10	15	20	0	5	10	15	20	0	5	10	15	20	0	5	10	15
protok zraka 3900 m <sup>3</sup> /h (brzina 3)																																		
izlaz topline	kW																																	
temperatura	°C																																	
protok vode	m <sup>3</sup> /h																																	
pad tlaka	kPa																																	
protok zraka 2500 m <sup>3</sup> /h (brzina 2)																																		
izlaz topline	kW																																	
temperatura	°C																																	
protok vode	m <sup>3</sup> /h																																	
pad tlaka	kPa																																	
protok zraka 1850 m <sup>3</sup> /h (brzina 1)																																		
izlaz topline	kW																																	
temperatura	°C																																	
protok vode	m <sup>3</sup> /h																																	
pad tlaka	kPa																																	

### HEATER CONDENS CR2

ulaz/izlaz temperature vode temperatura ulaznog zraka	50/30				50/40				60/40				70/50				80/60				90/70				120/90						
	0	5	10	15	20	0	5	10	15	20	0	5	10	15	20	0	5	10	15	20	0	5	10	15	20	0	5	10	15	20	
protok zraka 3350 m <sup>3</sup> /h (brzina 3)																															
izlaz topline	kW																														
temperatura	°C																														
protok vode	m <sup>3</sup> /h																														
pad tlaka	kPa																														
protok zraka 2000 m <sup>3</sup> /h (brzina 2)																															
izlaz topline	kW																														
temperatura	°C																														
protok vode	m <sup>3</sup> /h																														
pad tlaka	kPa																														
protok zraka 1450 m <sup>3</sup> /h (brzina 1)																															
izlaz topline	kW																														
temperatura	°C																														
protok vode	m <sup>3</sup> /h																														
pad tlaka	kPa																														

### HEATER CONDENS CR3

ulaz/izlaz temperature vode temperatura ulaznog zraka	50/30				50/40				60/40				70/50				80/60				90/70				120/90						
	0	5	10	15	20	0	5	10	15	20	0	5	10	15	20	0	5	10	15	20	0	5	10	15	20	0	5	10	15	20	
protok zraka 2950 m <sup>3</sup> /h (brzina 3)																															
izlaz topline	kW																														
temperatura	°C																														
protok vode	m <sup>3</sup> /h																														
pad tlaka	kPa																														
protok zraka 1700 m <sup>3</sup> /h (brzina 2)																															
izlaz topline	kW																														
temperatura	°C																														
protok vode	m <sup>3</sup> /h																														
pad tlaka	kPa																														
protok zraka 1200 m <sup>3</sup> /h (brzina 1)																															
izlaz topline	kW																														
temperatura	°C																														
protok vode	m <sup>3</sup> /h																														
pad tlaka	kPa																														



# GUARD ZRAČNA ZAVJESA

Novi GUARD dolazi sa modernim dizajnom, visokim performansama i punim rasponom opreme. GARD je sinonim za modernu, superiornu i naprednu tehnologiju.



## PREDNOSTI

- Moderan dizajn
- Visoke performanse, protok zraka 4800 m<sup>3</sup>/h, domet zraka do 4 m
- Tehnologija PTC električnih grijača
- Nivo niske buke, reducirana težina

## ZRAČNA ZAVJESA

### GUARD

- \* moderan dizajn
- \* bacanje zraka do 4 m
- \* dužina 100, 150, 200 cm
- \* CGA0051 - SET DRŽAČA
- \* kontrola brzine
- \* vodeni, električni i zračni izmjenjivač
- \* PFC tehnologija električnog grijača

ŠIFRA VOKEL	OPIS	SNAGA	ŠIFRA ARTIKLA
<b>1447009</b>	GUARD 150W	20-29 kW	CG0020+CGA0051
<b>1447010</b>	GUARD 200W	25-40 kW	CG0021+CGA0051
<b>1447011</b>	GUARD 200E	8,5-14 kW	CG0024+CGA0051
<b>1447013</b>	GUARD 100W	10-16kW	CG0019+CGA0051

## OPSEG HORIZONTALNOG PROTOKA ZRAKA

(maksimalna visina instalacije)

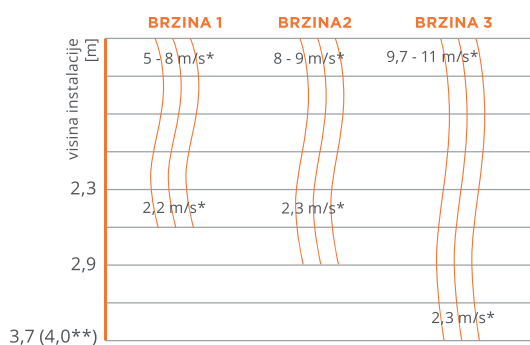

## OPSEG VERTIKALNOG PROTOKA ZRAKA

(maksimalni opseg kod vertikalne instalacije)

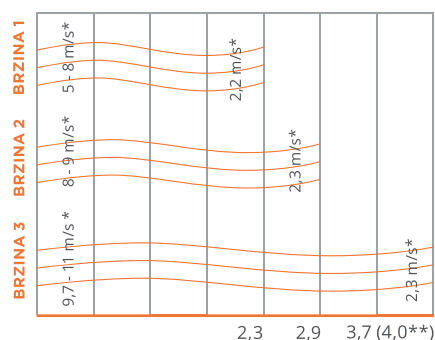

\* brzina protoka zraka  
\*\* ambijentalna zračna zavjesa

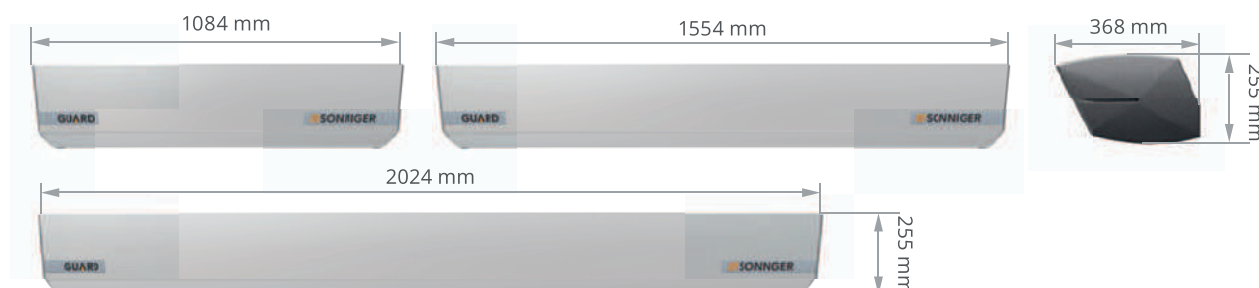

TEHNIČKI PODACI		ZRAČNA ZAVJESA S GRIJAČEM VODE			ZRAČNA ZAVJESA S ELEKTRIČNIM GRIJAČEM			ZRAČNA ZAVJESA BEZ GRIJANJA		
		GUARD 100W	GUARD 150W	GUARD 200W	GUARD 100E	GUARD 150E	GUARD 200E	GUARD 100C	GUARD 150C	GUARD 200C
duljina jedinice	m	1	1.5	2	1	1.5	2	1	1.5	2
maksimalna visina ugradnje	m	4	4	4	4	4	4	4	4	4
maksimalni protok zraka	m <sup>3</sup> /h	2000	3600	4800	2000	3600	4800	2100	3700	5000
opseg toplinskog učina*	kW	10-16	20-29	25-40	4 - 7	6,5 - 11	8,5 - 14	-	-	-
maksimalni radni tlak	MPa	1,6	1,6	1,6	-	-	-	-	-	-
promjer spojnih cijevi	cola	1/2"	1/2"	1/2"	-	-	-	-	-	-
napajanje	V/Hz A	230/50 1,95	230/50 2,6	230/50 2,6	230/50 1,95	230/50 2,6	230/50 2,6	230/50 1,95	230/50 2,6	230/50 2,6
snaga motora	W	220	320	320	220	320	320	220	320	320
potrošnja energije	V/Hz A	-	-	-	400/50 11	400/50 16,6	400/50 22,4	-	-	-
masa	kg	16,5	20,5	28	17	21,5	29	15	18,5	25
nivo zvuka	dB (A)	59	61	62	59	61	62	60	61	62
zaštita class IP	-	IP21	IP21	IP21	IP21	IP21	IP21	IP21	IP21	IP21

\* izlazna toplina za vodu 90/70°C i temperatura ulaznog zraka +10°C

### GUARD 100W

### ZRAČNE ZAVJESE protok zraka - 2000 m<sup>3</sup>/h

ulaz/izlaz temperatura vode		voda 60/40 °C					voda 70/50 °C					voda 90/70 °C				
ulazna temperatura zraka	°C	0	5	10	15	20	0	5	10	15	20	0	5	10	15	20
izlazna toplina	kW	9	7,9	6,9	5,8	4,8	11,3	10,3	9,2	8,1	7,1	16	14,9	13,9	12,8	11,7
izlazna temperature vode	°C	14,9	18,3	21,8	25,2	28,7	18,4	21,8	25,2	28,7	32,1	25,4	28,8	32,2	35,6	39
protok vode	m <sup>3</sup> /h	0,4	0,3	0,3	0,2	0,2	0,5	0,4	0,4	0,3	0,3	0,7	0,6	0,6	0,5	0,5
pad tlaka	kPa	2	2	1	1	1	4	3	2	2	1	7	6	5	5	4

### GUARD 150W

### ZRAČNE ZAVJESE protok zraka - 3600 m<sup>3</sup>/h

ulaz/izlaz temperatura vode		voda 60/40 °C					voda 70/50 °C					voda 90/70 °C				
ulazna temperatura zraka	°C	0	5	10	15	20	0	5	10	15	20	0	5	10	15	20
izlazna toplina	kW	17,4	15,6	13,8	12,1	10,3	21,3	19,5	17,7	15,9	14,1	29,0	27,2	25,4	23,6	21,8
izlazna temperature vode	°C	15,1	18,6	22,1	25,7	29,2	18,3	21,8	25,3	28,9	32,4	24,7	28,2	31,7	35,2	38,7
protok vode	m <sup>3</sup> /h	0,6	0,6	0,5	0,4	0,3	0,8	0,7	0,7	0,6	0,5	1,2	1,1	1	0,9	0,8
pad tlaka	kPa	8	6	4	3	2	12	10	8	6	5	22	19	17	14	12

### GUARD 200W

### ZRAČNE ZAVJESE protok zraka - 4800 m<sup>3</sup>/h

ulaz/izlaz temperatura vode		voda 60/40 °C					voda 70/50 °C					voda 90/70 °C				
ulazna temperatura zraka	°C	0	5	10	15	20	0	5	10	15	20	0	5	10	15	20
izlazna toplina	kW	24,7	22,3	19,9	17,5	15,1	29,8	27,4	25,0	22,6	20,2	40,0	37,6	35,2	32,8	30,4
izlazna temperature vode	°C	15,7	19,2	22,7	26,2	29,7	18,9	22,4	25,9	29,4	32,9	25,2	28,7	32,2	35,7	39,2
protok vode	m <sup>3</sup> /h	0,9	0,8	0,7	0,6	0,5	1,1	1	0,9	0,8	0,7	1,6	1,5	1,4	1,3	1,2
pad tlaka	kPa	15	12	9	7	5	22	19	15	12	9	42	37	32	27	23

### GUARD 100E, 150E, 200E

### ZRAČNE ZAVJESE

		GUARD 100E					GUARD 150E					GUARD 200E				
ulazna temperatura zraka	°C	0	5	10	15	20	0	5	10	15	20	0	5	10	15	20
izlazna toplina	kW	7	7	7	7	7	11	11	11	11	11	14	14	14	14	14
izlazna temperature	°C	12	17	22	27	32	13	18	23	28	33	14	19	24	29	34



PANEL COMFORT TR-110L  
REGULACIJA BRZINE I TERMOSTATA

ŠIFRA VOKEL	OPIS	ŠIFRA ARTIKLA
<b>1447012</b>	PANEL COMFORT	WAA0054



TR-010  
SOBNI TERMOSTAT

ŠIFRA VOKEL	OPIS	ŠIFRA ARTIKLA
<b>1447005</b>	SOBNI TERMOSTAT	WAA0029



ARW 1.3/E  
REGULATOR BRZINE

ŠIFRA VOKEL	OPIS	ŠIFRA ARTIKLA
<b>1447006</b>	REGULATOR BRZINE VRTNJE IP54 230-160 110 V	WAA0033



YWF4E-450B  
VENTILATOR ZA KALORIFER

ŠIFRA VOKEL	OPIS	ŠIFRA ARTIKLA
<b>1447018</b>	VENTILATOR ZA KALORIFER YWF4E-450B	WAA0053



ARW 1.3/1  
REGULATOR BRZINE

ŠIFRA VOKEL	OPIS	ŠIFRA ARTIKLA
<b>1447007</b>	REGULATOR BRZINE VRTNJE IP54 230-160 110 V	WAA0034



PANEL  
ZA AUTOMATSKI REGULATOR BRZINE

ŠIFRA VOKEL	OPIS	ŠIFRA ARTIKLA
<b>1447008</b>	PANEL ZA AUT.REG.BRZINE PSH3 HC RS485	WAA0035



MULTI 6  
RAZDJELNIK

ŠIFRA VOKEL	OPIS	ŠIFRA ARTIKLA
<b>1447015</b>	RAZDJELNIK MULTI 6( ZA GUARD I HEATER)	WAA0055

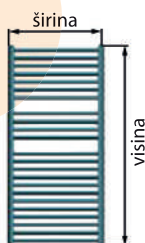

## KUPAONSKI RADIJATOR BIJELI

VOKEL ŠIFRA	ŠIRINA (mm)	VISINA (mm)	SNAGA (W)	TLAK (bar)	ŠIFRA ARTIKLA
<b>1467001</b>	450	800	275	10	DGS450800-WF
<b>1467002</b>	500	800	296	10	DGS500800-WF
<b>1467003</b>	550	800	325	10	DGS550800-WF
<b>1467004</b>	600	800	356	10	DGS600800-WF
<b>1467005</b>	450	1200	393	10	DGS4501200-WF
<b>1467006</b>	500	1200	430	10	DGS5001200-WF
<b>1467007</b>	550	1200	473	10	DGS5501200-WF
<b>1467008</b>	600	1200	516	10	DGS6001200-WF
<b>1467009</b>	450	1500	511	10	DGS4501500-WF
<b>1467010</b>	500	1500	538	10	DGS5001500-WF
<b>1467011</b>	550	1500	592	10	DGS5501500-WF
<b>1467012</b>	600	1500	645	10	DGS6001500-WF

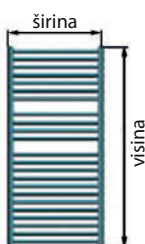
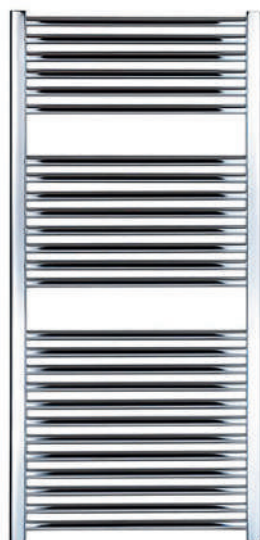

## KUPAONSKI RADIJATOR KROMIRANI

VOKEL ŠIFRA	ŠIRINA (mm)	VISINA (mm)	SNAGA (W)	TLAK (bar)	ŠIFRA ARTIKLA
<b>1467013</b>	450	800	234	10	DGS450800-CF
<b>1467014</b>	500	800	253	10	DGS500800-CF
<b>1467015</b>	550	800	278	10	DGS550800-CF
<b>1467016</b>	600	800	303	10	DGS600800-CF
<b>1467017</b>	450	1200	335	10	DGS4501200-CF
<b>1467018</b>	500	1200	365	10	DGS5001200-CF
<b>1467019</b>	550	1200	401	10	DGS5501200-CF
<b>1467020</b>	600	1200	437	10	DGS6001200-CF
<b>1467021</b>	450	1500	435	10	DGS4501500-CF
<b>1467022</b>	500	1500	457	10	DGS5001500-CF
<b>1467023</b>	550	1500	502	10	DGS5501500-CF
<b>1467024</b>	600	1500	547	10	DGS6001500-CF

## AF - CN



Hibridni radijatori  

BIJELI



CRNI



KROM



## KARAKTERISTIKE

- U skladu sa standardom EN442
- Pametni sustav kontrole temperature obećava sigurnost
- Podržava prilagodbu snage, veličine, završne obrade i boje
- Mogućnost grijanja na struju ili priključivanja na centralno grijanje



Higijenski



Otporan na vlagu



Moderan dizajn

Materijal: čelik

Površinska temperatura:  $55^{\circ}\text{C} \pm 3^{\circ}\text{C}$

Završna obrada: kromiranje / praškasti premaz





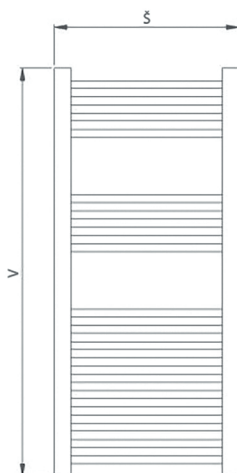

ŠIFRA VOKEL	BOJA	DIMENZIJE (mm)	BROJ CIJEVI	SNAGA (W)	ŠIFRA ARTIKLA
<b>1469001</b>	BIJELA	450x700	13	238	AF-CNW07045
<b>1469002</b>	BIJELA	450x1150	21	386	AF-CNW11545
<b>1469003</b>	BIJELA	450x1500	29	522	AF-CNW15045
<b>1469004</b>	BIJELA	450x1800	39	675	AF-CNW18045
<b>1469005</b>	BIJELA	500x700	13	258	AF-CNW07050
<b>1469006</b>	BIJELA	500x1150	21	419	AF-CNW11550
<b>1469007</b>	BIJELA	500x1500	29	567	AF-CNW15050
<b>1469008</b>	BIJELA	500x1800	39	734	AF-CNW18050
<b>1469009</b>	BIJELA	600x700	13	298	AF-CNW07060
<b>1469010</b>	BIJELA	600x1150	21	483	AF-CNW11560
<b>1469011</b>	BIJELA	600x1500	29	656	AF-CNW16060
<b>1469012</b>	BIJELA	600x1800	39	854	AF-CNW18060

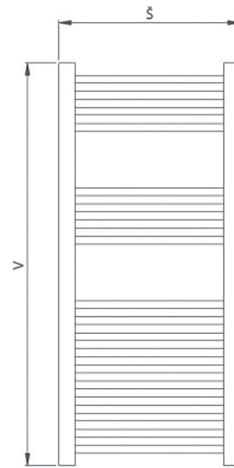

ŠIFRA VOKEL	BOJA	DIMENZIJE (mm)	BROJ CIJEVI	SNAGA (W)	ŠIFRA ARTIKLA
<b>1469021</b>	KROM	450x700	13	188	AF-CNC07045 CHROME
<b>1469022</b>	KROM	450x1150	21	305	AF-CNC11545 CHROME
<b>1469023</b>	KROM	450x1500	29	413	AF-CNC15045 CHROME
<b>1469024</b>	KROM	450x1800	39	533	AF-CNC18045 CHROME
<b>1469013</b>	KROM	500x700	13	204	AF-CNC07050
<b>1469014</b>	KROM	500x1150	21	331	AF-CNC11550
<b>1469015</b>	KROM	500x1500	29	448	AF-CNC15050
<b>1469016</b>	KROM	500x1800	39	580	AF-CNC18050
<b>1469025</b>	KROM	600x700	13	235	AF-CNC07060 CHROME
<b>1469026</b>	KROM	600x1150	21	382	AF-CNC11560 CHROME
<b>1469027</b>	KROM	600x1500	29	518	AF-CNC16060 CHROME
<b>1469028</b>	KROM	600x1800	39	675	AF-CNC18060 CHROME



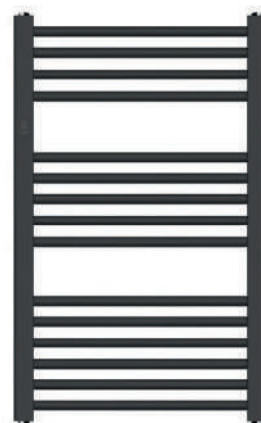
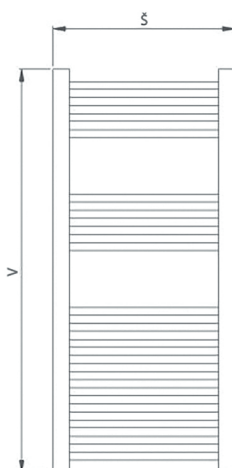

ŠIFRA VOKEL	BOJA	DIMENZIJE (mm)	BROJ CIJEVI	SNAGA (W)	ŠIFRA ARTIKLA
<b>1469029</b>	CRNA	450x700	13	238	AF-CNB07045 MAT BLACK
<b>1469030</b>	CRNA	450x1150	21	386	AF-CNB11545 MAT BLACK
<b>1469031</b>	CRNA	450x1500	29	522	AF-CNB15045 MAT BLACK
<b>1469032</b>	CRNA	450x1800	39	675	AF-CNB18045 MAT BLACK
<b>1469017</b>	CRNA	500x700	13	258	AF-CNB07050
<b>1469018</b>	CRNA	500x1150	21	419	AF-CNB11550
<b>1469019</b>	CRNA	500x1500	29	567	AF-CNB15050
<b>1469020</b>	CRNA	500x1800	39	734	AF-CNB18050
<b>1469033</b>	CRNA	600x700	13	298	AF-CNB07060 MAT BLACK
<b>1469034</b>	CRNA	600x1150	21	483	AF-CNB11560 MAT BLACK
<b>1469035</b>	CRNA	600x1500	29	656	AF-CNB16060 MAT BLACK
<b>1469036</b>	CRNA	600x1800	39	854	AF-CNB18060 MAT BLACK

### Nosači

ŠIFRA VOKEL	OPIS	ŠIFRA ARTIKLA
<b>1469037</b>	NOSAČ ZA KUPAONSKI RADIJATOR - BIJELI	AF-BKW01
<b>1469038</b>	NOSAČ ZA KUPAONSKI RADIJATOR - KROM	AF-BKC01
<b>1469039</b>	NOSAČ ZA KUPAONSKI RADIJATOR - CRNI	AF-BKB01



## UPUTSTVA ZA UGRADNJU:

Radijator mora biti pričvršćen najmanje 21 cm iznad tla (mjereno od najniže točke radijatora ili grijača ako imate električni cijevni radijator). Nosači moraju biti pričvršćeni na zid od opeke ili betona kako bi se osigurala sigurna ugradnja i kasnija upotreba. Instalacija se mora obaviti u skladu s propisima koji se odnose na električne (u slučaju električnih radijatora) i vodovodne / centralne instalacije.

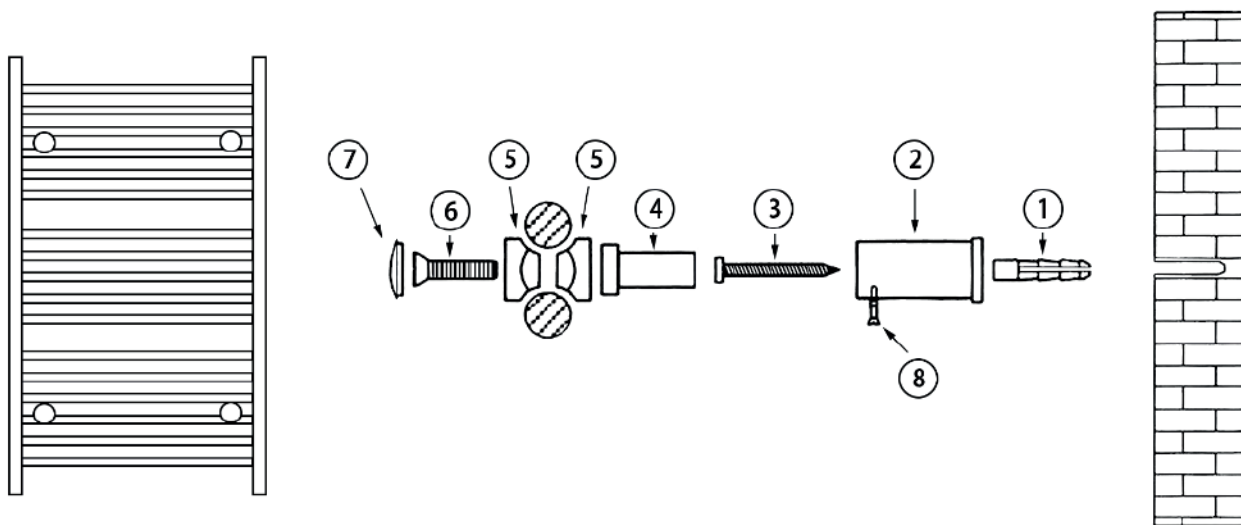

## DODATNE UPUTE ZA ELEKTRIČNI RADIJATOR:

Radijator u koji ste ugradili grijač mora biti okomito pričvršćen na zid. (Grijač mora biti ispod, lijevo ili desno). Napunite radijator vodom do polovine gornje cijevi (ili 90% zapremine). Možete dodati 5-10% antifrizu u vodu, ovisno o opasnosti od niskih sobnih temperatura.

## ČIŠĆENJE RADIJATORA:

Čistiti samo čistom vodom i tekućim sredstvima za čišćenje. Nikada nemojte koristiti abrazivna i / ili kemijska sredstva za čišćenje.

## UDALJENOST RADIJATORA OD WC-a:

Radijatori nisu otporni na mokraćnu kiselinu pa preporučujemo da radijator bude udaljen najmanje 1 m od WC-a. Time se izbjegava hrđanje radijatora prebrzo, što nije posljedica neodgovarajuće kvalitete.

## UPOZORENJE:

Proizvod nije igračka. Sprječite djecu da se penju na proizvod jer to može ugroziti sigurnost djece i oštetiti proizvod. Ne koristite radijator za druge svrhe osim za grijanje i sušenje ručnika.

## JAMSTVO:

5 godina jamstva na obojene proizvode (praškasti premaz), 3 godine jamstva na proizvode s kromiranom i zlatnom površinom (pocinčavanje), 2 godine na električne grijače za cijevne radijatore.

## PROIZVOĐAČ NE PREUZIMA ODGOVORNOST:

Zbog oštećenja u slučaju nepoštivanja uputa za ugradnju, transportnog oštećenja proizvoda od trgovine do kupca, oštećenja uslijed mraza, oštećenja zbog nepravilne upotrebe proizvoda, oštećenja uslijed izlivanja, druga oštećenja.

U slučaju reklamacija kontaktirajte trgovca kod kojeg ste kupili proizvod na način da:

- pošaljete kopiju računa (ne možete podnijeti žalbu bez računa)
- pošaljete sliku lokacije proizvoda u kupaonici i sliku razloga žalbe (npr. puštanje)
- opišete žalbu

U slučaju opravdane reklamacije imate pravo na novi proizvod (potrebno je vratiti stari proizvod). Ostale troškove (npr. isporuka, isporuka novog proizvoda, troškovi zamjene...) snosi kupac.

Želimo Vam zadovoljstvo pri korištenju proizvoda.





**ENERGY CONTROL IN YOUR HOME**



# E10W230WIFI / E10B230WIFI

## Digitalni Internet žičani termostat

E10 je žičani temperaturni termostat s WiFi i Bluetooth modulom. Omogućuje ekonomičnu i ekološku kontrolu bilo koje vrste grijanja. Omogućuje daljinsko upravljanje sustavom grijanja pomoću ENGO Smart / Tuya Smart aplikacije.

Programiranje E10 je vrlo jednostavno i omogućuje vam da prilagodite ciklus grijanja vašem dnevnom ritmu.

### Karakteristike proizvoda:

- minimalistički dizajn
- mogućnost djeljenja uređaja s više korisnika
- grafikoni povijesti temperature dostupni u aplikaciji
- mogućnost postavljanja min. i max. zadane temperature
- push obavijest iz aplikacije
- podesiva jačina pozadinskog osvjetljenja zaslona
- mogućnost spajanja dodatnog NTC senzora
- mnoštvo funkcija dostupnih iz aplikacije ENGO Smart/Tuya Smart
- vrlo jednostavno korištenje

Napajanje	230V AC 50Hz
Maksimalno opterećenje	3 (1) A
Raspon regulacije temperature	5 - 45°C
Točnost prikaza temperature	0.1°C
Upravljački algoritam	TPI ili histereza ( ±0.1°C ili ±0.5°C)
Komunikacija	WiFi 2,4 GHz
Ulaz S1 - S2	Temperatura poda ili mjerenje temperature zraka
Upravljački izlaz	NO/COM (bez napona)
Klasa zaštite	IP30
Dimenzije [mm]	86 x 86 x 39 ( 14 nakon ugradnje u kutiju, promjer 60 )



ŠIFRA VOKEL	BOJA	ŠIFRA ARTIKLA	PAKIRANJE
<b>1495001</b>	BIJELO	E10W230WIFI	1
<b>1495002</b>	CRNO	E10B230WIFI	1

# EASY230 / EASYBAT

## Sobni žičani termostat za grijanje i hlađenje

Žičani, dnevni regulator temperature, na napajanje ili baterije (2xAAA). Služi za žičano upravljanje grijačim ili rashladnim uređajima i sustavima. Njegova funkcija je održavanje ugodnih uvjeta u prostoriji u skladu s temperaturom koju je korisnik postavio. Spaja se neposredno na izvor topline ili upravljačku traku. Za bolje pristajanje, model je dostupan u dvije boje. Siguran, pouzdan, jednostavan za korištenje.

Napajanje	230W
Napajanje baterijsko	2xAAA baterije
Maksimalno opterećenje	3 (1) A
Temperaturni raspon	5 - 35°C
Preciznost mjerenja	0.1°C
Upravljački algoritam	TPI ili histereza ( ±0.2°C - ±0.2°C)
Komunikacija	Žičana
Upravljački izlaz	NO/COM (bez napona)
Klasa zaštite	IP30
Dimenzije [mm]	80 x 80 x 22

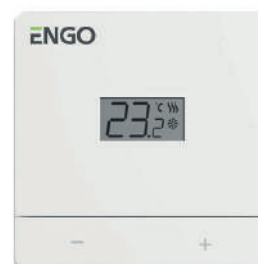

ŠIFRA VOKEL	BOJA	ŠIFRA ARTIKLA	PAKIRANJE
<b>1495005</b>	BIJELO	EASY230W	1
<b>1495006</b>	CRNO	EASY230B	1

## Sobni žičani termostat sa baterijskim napajanjem

ŠIFRA VOKEL	BOJA	ŠIFRA ARTIKLA	PAKIRANJE
<b>1495008</b>	BIJELO	EASYBATW	1
<b>1495007</b>	CRNO	EASYBATB	1

## E901WIFI

### Internet bežični termostat, Wifi

E901WIFI je bežični Wi-Fi termostat koji omogućuje ekonomičnu i ekološku kontrolu bilo koje vrste grijanja. Odlikuje se preglednim izbornikom i mnoštvom korisnih funkcije. Rukovanje termostatom je vrlo jednostavno i omogućuje korisniku da prilagodi ciklus grijanja dnevnom ritmu korisnika.

Ugrađeni Wi-Fi modul omogućuje daljinsko upravljanje sustavom grijanja pametnim telefonom ili tabletom pomoću aplikacije ENG Smart / TUYA Smart

#### Karakteristike proizvoda:

- mogućnost odabira histereze ili ugrađenog TPI algoritma
- programabilna promjena tipa releja
- blokada PIN-om
- mnoštvo funkcija dostupnih iz aplikacije ENGO Smart/Tuya Smart
- ograničavanje maksimalne i minimalne temperature
- funkcija Grijanje / Hlađenje
- ima jedinstvene kodove prijenesa
- automatski obnavlja radni signal



Napajanje	2XAA alkalne baterije
Napajanje prijemnika	230V AC 50Hz
Maksimalno opterećenje prijemnika	16 (5) A
Izlazni signal prijemnika	NO/COM relej bez napona
Raspon kontrole temperature	5° - 35°C
Prikaz točnosti temperature	0,5°C
Kontrolni algoritam	TPI ili Histereza (+/-0,25°C ili +/- 0,5°C)
Komunikacija	Bežični, 868 MHz i WiFi 2.4GHz
Dimenzije [mm]	odašiljač: 150 x 84 x 22 prijemnik: 96 x 96 x 27

ŠIFRA VOKEL	BOJA	ŠIFRA ARTIKLA	PAKIRANJE
1495011	BIJELO	E901WIFI	1

## E901RF

### Programabilni bežični termostat

E901RF je nadgradni, tjedni sobni regulator, koji se koristi za bežično upravljanje uređajima i sustava grijanja (npr. plinski ili uljni kotlovi, toplinske pumpe) ili hlađenja. Ima funkciju kreiranja vlastitih rasporeda. Zahvaljujući ugrađenim algoritmima, nudi mnogo bolju točnost kontrole temperature od tradicionalnog mehaničkog termostata. E901RF Regulator je tvornički uparen s prijemnikom.

Ugrađeni Wi-Fi modul omogućuje daljinsko upravljanje sustavom grijanja pametnim telefonom ili tabletom pomoću aplikacije ENG Smart / TUYA Smart

#### Karakteristike proizvoda:

- dvije vrste vremenskih rasporeda
- ograničenje maksimalne/minimalne temperature
- funkcija Grijanje/Hlađenje
- značajka zaključavanja tipki
- jedinstveni kodovi za prijenos
- automatsko ponavljanje signala
- može se odabrati histereza ili ugrađeni TPI algoritam
- softverska promjena tipa releja - (NO) pod naponom otvoren ili (NC) pod naponom zatvoren
- PIN zaključavanje
- za upravljanje podnim ili izvorom grijanja
- radni domet do 100m na otvorenom prostoru



Napajanje	2 x AA alkalne baterije
Napajanje prijemnika	230V AC 50Hz
Maksimalno opterećenje	16 (5) A
Izlazni signal	NO/COM relej bez napona
Raspon regulacije temperature	5 – 35°C
Prikaz točnosti temperature	0,1°C ili 0,5°C
Upravljački algoritam	TPI ili histereza (± 0,25°C ili ± 0,5°C)
Komunikacija	Bežična, 868 MHz
Dimenzije [mm]	odašiljač: 150 x 84 x 22 prijemnik: 96 x 96 x 27

ŠIFRA VOKEL	BOJA	ŠIFRA ARTIKLA	PAKIRANJE
1495010	BIJELO	E901RF	1

## Upravljačka letva za 8 zona podnog grijanja

Upravljačka traka ECB08M230 glavni je element upravljačkog sustava podnog grijanja. Ima ugrađene module koji kontroliraju izvore topline (beznaponski relej) i pumpe (230V AC). Upravljačka kutija omogućuje upravljanje 8 različitih zona. Opremljena je 230V AC izlaznim naponom za aktuator. Utični blokovi terminala omogućuju brzo i praktično povezivanje ožičenja. Upravljačka kutija je dizajnirana za rad s NC (normalno zatvorenim) aktuatorima/pogonima.

### Karakteristike proizvoda:

- kontrola 8 neovisnih zona grijanja
- naponski izlaz za upravljanje cirkulacijske pumpe
- lagano kućište/lagano kućište
- ugrađeni upravljački modul izvora topline (beznaponski kontakt)
- praktični terminali koji se mogu ukloniti za jednostavno spajanje žica
- 2 namijenjena izlaza aktuatora za svaku od 8 zona
- prilagođena za montažu na DIN šinu
- dizajnirana za ožičene termostate
- ugrađena funkcija odgode uključivanja pumpe i kotla - 3 min.



Napajanje	230V AC 50Hz
Maksimalno opterećenje	6 (1) A Pumpa (230V)
Izlazi	Kotao (NO/COM/NC) Termoelektrični aktuatori (230V)
Dimenzije [mm]	330 x 110 x 36

ŠIFRA VOKEL	BOJA	ŠIFRA ARTIKLA	PAKIRANJE
<b>1495003</b>	CRNO	ECB08M230	1

## E30NC230 / E28NC230

### Motorni pogon za ventile

Termoelektrični aktuator je namijenjen za korištenje sa sustavima podnog grijanja. Može se koristiti s termostatskim ventilima u 980 - 990 razdjelniku za podno grijanje ili sa zonskim ventilima. Omogućuje otvaranje ili zatvaranje protoka medija za grijanje u petlji, što vam daje kontrolu nad sobnom temperaturom. Suraduje izravno s termostatom ili neizravno preko upravljačke trake.

### Karakteristike proizvoda:

- funkcija "First Open" - olakšava prvu instalaciju
- niska potrošnja energije
- male dimenzije
- velik raspon
- brzo vrijeme otvaranja
- moderan dizajn, visoka izdržljivost

Verzija	NC = Normalno zatvoren
Dimenzija navoja	M30 x 1.5 mm, M28 x 1.5mm
Napajanje	230V AC 50Hz
Potrošnja energije	2W
Struja pokretanja	300mA / 200ms
Snaga pritiska	100N +/- 15%
Max. raspon	4,5 mm
Temp. skladištenja	-25°C do 60°C
Temp. okoline	max. 60°C
Klasa zaštite	IP 54 / II
Debljina kabela	90 cm
Dimenzije [mm]	Ø 41 x 65



ŠIFRA VOKEL	BOJA	ŠIFRA ARTIKLA	PAKIRANJE
<b>1495004</b>	CRNO	E30NC230	1
<b>1495009</b>	CRNO	E28NC230	1

## BEZELW

### Okvir za termostat

Okvir za termostat serije EASY E20

Minimalistički i elegantan okvir za površinsku montažu regulatora temperature. Izdržljiv i čvrst. Omogućuje stabilnu ugradnju upravljačkog uređaja, savršeno nadopunjujući njegov dizajn u svakom interijeru.



ŠIFRA VOKEL	BOJA	ŠIFRA ARTIKLA	PAKIRANJE
<b>1495012</b>	BIJELA	BEZELW	1

## BEZELB

### Okvir za termostat

Okvir za termostat serije EASY E20

Minimalistički i elegantan okvir za površinsku montažu regulatora temperature. Izdržljiv i čvrst. Omogućuje stabilnu ugradnju upravljačkog uređaja, savršeno nadopunjujući njegov dizajn u svakom interijeru.



ŠIFRA VOKEL	BOJA	ŠIFRA ARTIKLA	PAKIRANJE
<b>1495013</b>	CRNA	BEZELB	1

## ECB02M230

### Modul za 2 kruga grijanja

Modul za 2 kruga grijanja s glavnom pumpom i regulacijom izvora grijanja.

Modul kruga grijanja omogućuje upravljanje dvjema neovisnim toplinskim zonama na koje su spojeni regulatori temperature i cirkulacijske pumpe.

Koristi se u standardom obiteljskom domu, gdje postoje podjele u 2 kruga

grijanja (npr. 1 krug prvog kata i 2 krug drugog kata). Tada signal koji dolazi iz bilo kojeg kruga grijanja aktivira izlaze prema glavnoj cirkulacijskoj pumpi i izvoru topline u regulatoru. Integrator se također može koristiti za male (npr. dvozonске) sustave podnog grijanja.

Napajanje	230V AC 50Hz
Maksimalna struja	3A
Izlazi	230V Bojler (NO/COM/NC10)
Dimenzije [mm]	150 x 90 x 35



ŠIFRA VOKEL	BOJA	ŠIFRA ARTIKLA	PAKIRANJE
<b>1495014</b>	CRNA	ECB02M230	1

## E55B230WIFI

### Ugradbeni WIFI termostat

Ugradbeni regulator temperature za ugradnju u okvir 55x55 mm.

Dizajniran za kontrolu površinskog zagrijavanja koje karakterizira visoka toplinska inercija. Također može kontrolirati bilo koju drugu vrstu grijanja, kao i sustave hlađenja – prema potrebama i postavkama korisnika.

Ugrađeni Wi-Fi modul omogućuje jednostavnu instalaciju i upravljanje sustavom grijanja pomoću mobilne aplikacije ENGO Smart.

Napajanje	230V AC 50Hz
Maksimalna struja	3 (1) A
Izlazni signal	NO/COM (beznaponski relej)
Raspon regulacije temperature	5 – 45°C
Prikaz točnosti temperature	0,1°C
Upravljački algoritam	Histereza (±0,2°C do ±2,0°C)
Komunikacija	Wi-Fi 2,4 GHz
Dimenzije [mm]	55 x 55 x 39 (17 nakon montaže u kutiju promjera 60)



ŠIFRA VOKEL	BOJA	ŠIFRA ARTIKLA	PAKIRANJE
<b>1495015</b>	CRNA	E55B230WIFI	1

## E55W230WIFI

### Ugradbeni WIFI termostat

Ugradbeni regulator temperature za ugradnju u okvir 55x55 mm.

Dizajniran za kontrolu površinskog zagrijavanja koje karakterizira visoka toplinska inercija. Također može kontrolirati bilo koju drugu vrstu grijanja, kao i sustave hlađenja – prema potrebama i postavkama korisnika.

Ugrađeni Wi-Fi modul omogućuje jednostavnu instalaciju i upravljanje sustavom grijanja pomoću mobilne aplikacije ENGO Smart.

Napajanje	230V AC 50Hz
Maksimalna struja	3 (1) A
Izlazni signal	NO/COM (beznaponski relej)
Raspon regulacije temperature	5 – 45°C
Prikaz točnosti temperature	0,1°C
Upravljački algoritam	Histereza (±0,2°C do ±2,0°C)
Komunikacija	Wi-Fi 2,4 GHz
Dimenzije [mm]	55 x 55 x 39 (17 nakon montaže u kutiju promjera 60)



ŠIFRA VOKEL	BOJA	ŠIFRA ARTIKLA	PAKIRANJE
<b>1495016</b>	BIJELA	E55W230WIFI	1





NADGRADNI UMIVAONIK GAP

530 x 270 mm

VOKEL ŠIFRA	DIMENZIJA [mm]	ŠIFRA ARTIKLA	PAKIRANJE
<b>1109216</b>	530 x 270	3270Y0000	1

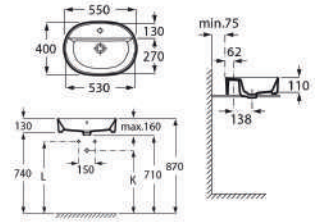

NADGRADNI UMIVAONIK GAP

550 x 390 mm

VOKEL ŠIFRA	DIMENZIJA [mm]	ŠIFRA ARTIKLA	PAKIRANJE
<b>1109217</b>	530 x 270	3270Y1000	1

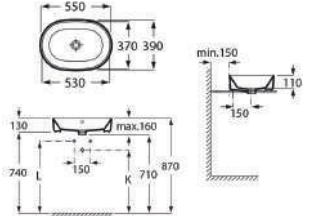

NADGRADNI UMIVAONIK GAP

600 x 370 mm

VOKEL ŠIFRA	DIMENZIJA [mm]	ŠIFRA ARTIKLA	PAKIRANJE
<b>1109218</b>	600 x 370	3270Y200	1

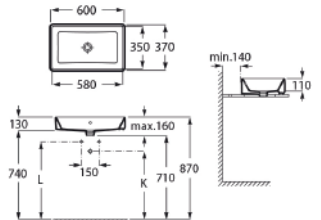

NADGRADNI UMIVAONIK GAP

600 x 420 mm

VOKEL ŠIFRA	DIMENZIJA [mm]	ŠIFRA ARTIKLA	PAKIRANJE
<b>1109219</b>	600 x 420	3270MN000	1

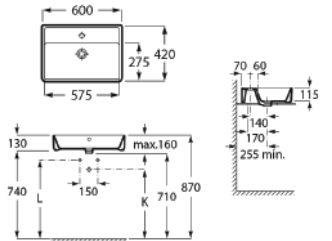

# Kupaonski namještaj



ARMA 80

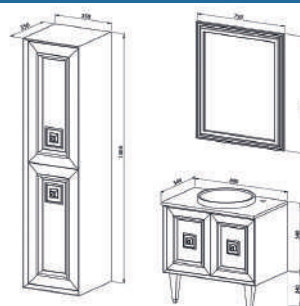

ŠIFRA VOKEL	OPIS	DIMENZIJE (mm)	ŠIFRA ARTIKLA	PAKIRANJE
<b>1722026</b>	ORMARIĆ ISPOD UMIVAONIKA ARMA 80 MATT ZELENI	800 x 500	M0003727	1
<b>1722027</b>	OGLEDALO ARMA MATT ZELENI	900 x 750	M0003736	1
<b>1722028</b>	BOČNI ORMAR ARMA TALL UNIT MATT ZELENI	1400 x 350 x 350	M0003733	1
<b>1722039</b>	MRAMORNA PLOČA ISPOD UMIVAONIKA ARMA 80	-	M0004074	1
<b>1722040</b>	POLUUGRADNI UMIVAONIK SANOVIT FI43 3041	-	H0004799	1

CAPELLA 120

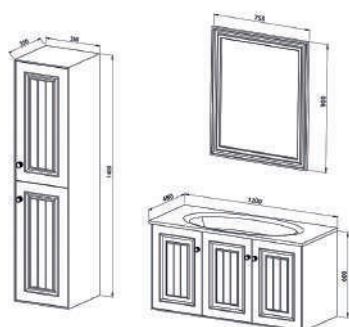

ŠIFRA VOKEL	OPIS	DIMENZIJE (mm)	ŠIFRA ARTIKLA	PAKIRANJE
<b>1722023</b>	ORMARIĆ ISPOD UMIVAONIKA CAPELLA 120 MATT PLAVI	1200 x 480	M0003769	1
<b>1722024</b>	OGLEDALO CAPELLA MATT PLAVI	900 x 750	M0003776	1
<b>1722025</b>	BOČNI ORMARIĆ CAPELLA TALL UNIT MATT PLAVI	1400 x 350 x 350	M0003772	1
<b>1722038</b>	UMIVAONIK KALE SPIRIT ETAJLERI	120 x 480	H0004832	1

CAPELLA 80



ŠIFRA VOKEL	OPIS	DIMENZIJE (mm)	ŠIFRA ARTIKLA	PAKIRANJE
<b>1722045</b>	ORMARIĆ ISPOD UMIVAONIKA CAPELLA 80 MATT PLAVI	800 x 480	M0003766	1
<b>1722024</b>	OGLEDALO CAPELLA MATT PLAVI	900 x 750	M0003776	1
<b>1722025</b>	BOČNI ORMARIĆ CAPELLA TALL UNIT MATT PLAVI	1400 x 350 x 350	M0003772	1
<b>1722046</b>	UMIVAONIK KALE SPIRIT ETAJLERI	800 x 480	H0004831	1



CAPELLA 120

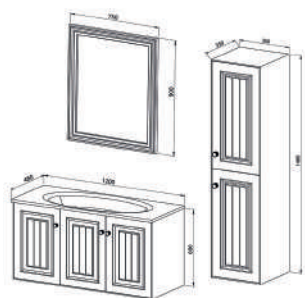

ŠIFRA VOKEL	OPIS	DIMENZIJE (mm)	ŠIFRA ARTIKLA	PAKIRANJE
<b>1722054</b>	ORMARIĆ ISPOD UMIVAONIKA CAPELLA 120 MATT LIGHT GREY	1200 x 480	M0003770	1
<b>1722053</b>	OGLEDALO CAPELLA MATT LIGHT GREY	900 x 750	M0003775	1
<b>1722056</b>	BOČNI ORMARIĆ CAPELLA TALL UNIT MATT LIGHT GREY	1400 x 350 x 350	M0003773	1
<b>1722038</b>	UMIVAONIK KALE SPIRIT ETAJLERI	120 x 480	H0004832	1

CAPELLA 80

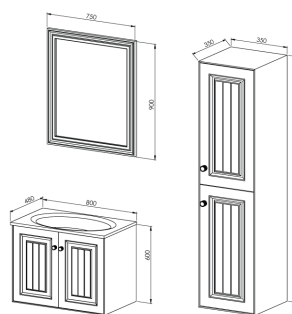

ŠIFRA VOKEL	OPIS	DIMENZIJE (mm)	ŠIFRA ARTIKLA	PAKIRANJE
<b>1722055</b>	ORMARIĆ ISPOD UMIVAONIKA CAPELLA 80 MATT LIGHT GREY	800 x 480	M0003767	1
<b>1722053</b>	OGLEDALO CAPELLA MATT LIGHT GREY	900 x 750	M0003775	1
<b>1722056</b>	BOČNI ORMARIĆ CAPELLA TALL UNIT MATT LIGHT GREY	1400 x 350 x 350	M0003773	1
<b>1722046</b>	UMIVAONIK KALE SPIRIT ETAJLERI	800 x 480	H0004831	1

VANITY 90

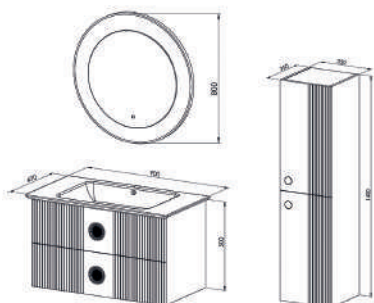

ŠIFRA VOKEL	OPIS	DIMENZIJE (mm/Ø)	ŠIFRA ARTIKLA	PAKIRANJE
<b>1722021</b>	ORMARIĆ ISPOD UMIVAONIKA VANITY 90 MATT SIVI	900 x 470	M0003717	1
<b>1720021</b>	OGLEDALO AMBER SA LED RASVJETOM	Ø80	S-4601 - 80	1
<b>1722022</b>	BOČNI ORMARIĆ VANITY TALL UNIT MATT SIVI	1400 x 350 x 350	M0003725	1
<b>1722037</b>	UMIVAONIK SANOVIT SHARP 14090	880 x 470	H0001527	1

**ALEA 80**

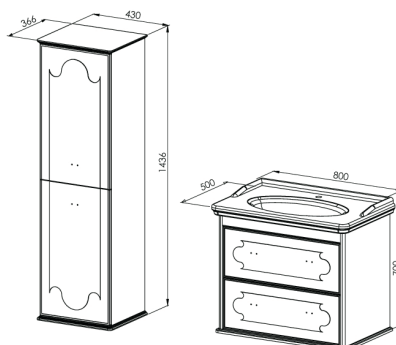

ŠIFRA VOKEL	OPIS	DIMENZIJE (mm)	ŠIFRA ARTIKLA	PAKIRANJE
<b>1722058</b>	ORMARIĆ ISPOD UMIVAONIKA ALEA 80 MATT SIVI	800 x 500	M0002948	1
<b>1722057</b>	OGLEDALO ALEA SIVO	750 x 1000	M0003085	1
<b>1722060</b>	BOČNI ORMARIĆ ALEA TALL UNIT MATT SIVI	1436 x 430 x 366	M0002951	1
<b>1722059</b>	UMIVAONIK KALE ARTDECO 80x50	800 x 500	H0001936	1

**ROMA 120**

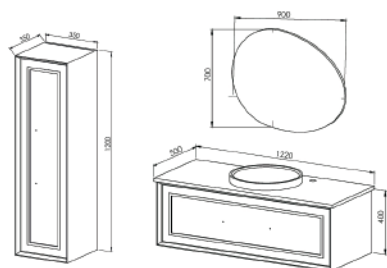

ŠIFRA VOKEL	OPIS	DIMENZIJE (mm)	ŠIFRA ARTIKLA	PAKIRANJE
<b>1722064</b>	ORMARIĆ ISPOD UMIVAONIKA ROMA 120	1200 x 500	M0004341	1
<b>1722065</b>	MRAMORNA PLOČA ISPOD UMIVAONIKA ARMA - ROMA 120	-	M0004075	1
<b>1722040</b>	POLUUGRADNI UMIVAONIK SANOVIT FI40 3041	Ø40	H0004799	1
<b>1722066</b>	BOČNI ORMARIĆ ROMA TALL UNIT MAT SIVI	1200 x 350 x 350	M0004342	1

**ROMA 120**

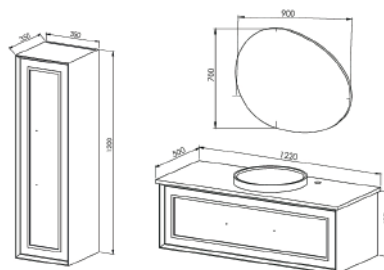

ŠIFRA VOKEL	OPIS	DIMENZIJE (mm)	ŠIFRA ARTIKLA	PAKIRANJE
<b>1722067</b>	ORMARIĆ ISPOD UMIVAONIKA ROMA MAT PLAVI 120	1200 x 500	M0004261	1
<b>1722065</b>	MRAMORNA PLOČA ISPOD UMIVAONIKA ARMA - ROMA 120	1200	M0004075	1
<b>1722040</b>	POLUUGRADNI UMIVAONIK SANOVIT	Ø43	H0004799	1
<b>1722068</b>	BOČNI ORMARIĆ ROMA TALL UNIT MAT PLAVI	1200 x 350 x 350	M0004263	1



## ZEN 100

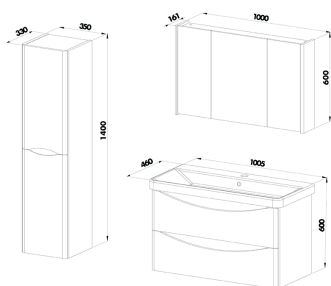

ŠIFRA VOKEL	OPIS	DIMENZIJE (mm)	ŠIFRA ARTIKLA	PAKIRANJE
<b>1722014</b>	ORMARIĆ ISPOD UMIVAONIKA ZEN 100 BIJELI	1005 x 460	M0003150	1
<b>1722015</b>	OGLEDALO-ORMARIĆ ZEN 100 BIJELI	1000 x 161	M0003168	1
<b>1722020</b>	BOČNI ORMARIĆ ZEN TALL UNIT BIJELI	1400 x 350 x 330	M0003171	1
<b>1722034</b>	UMIVAONIK SANOVIT LUXURY 11105	105 x 460	H0000983	1

## ZEN 80

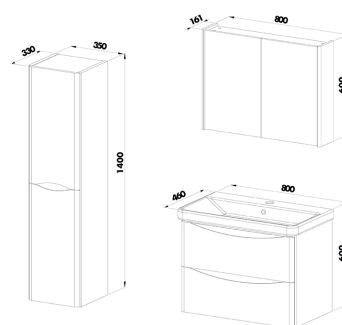

ŠIFRA VOKEL	OPIS	DIMENZIJE (mm)	ŠIFRA ARTIKLA	PAKIRANJE
<b>1722016</b>	ORMARIĆ ISPOD UMIVAONIKA ZEN 80 BIJELI	800 x 460	M0003128	1
<b>1722017</b>	OGLEDALO-ORMARIĆ ZEN 80 BIJELI	800 x 161	M0003155	1
<b>1722020</b>	BOČNI ORMARIĆ ZEN TALL UNIT BIJELI	1400 x 350 x 330	M0003171	1
<b>1722035</b>	UMIVAONIK SANOVIT LUXURY 11080	805 x 460	H0000982	1

## ZEN 60

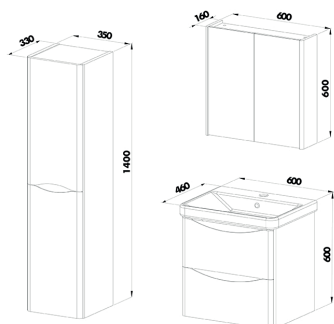

ŠIFRA VOKEL	OPIS	DIMENZIJE (mm)	ŠIFRA ARTIKLA	PAKIRANJE
<b>1722018</b>	ORMARIĆ ISPOD UMIVAONIKA ZEN 60 BIJELI	600 x 460	M0003126	1
<b>1722019</b>	OGLEDALO-ORMARIĆ ZEN 60 BIJELI	600 x 160	M0003164	1
<b>1722020</b>	BOČNI ORMARIĆ ZEN TALL UNIT BIJELI	1400 x 350 x 330	M0003171	1
<b>1722036</b>	UMIVAONIK SANOVIT LUXURY 60 11060	605 x 460	H0000981	1



ZEN 40

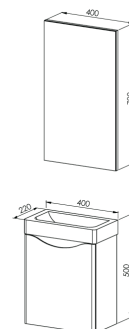

ŠIFRA VOKEL	OPIS	DIMENZIJE (mm)	ŠIFRA ARTIKLA	PAKIRANJE
<b>1722061</b>	ORMARIĆ ISPOD UMIVAONIKA ZEN 40	400x220	M0004298	1
<b>1722062</b>	UMIVAONIK LITOS 2240	400x220	H0002239	1
<b>1722063</b>	OGLEDALO ZEN	400x700	M0004299	1

RIO 55

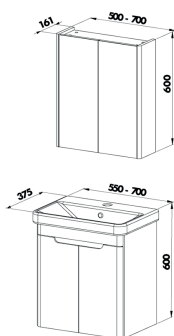

ŠIFRA VOKEL	OPIS	DIMENZIJE (mm)	ŠIFRA ARTIKLA	PAKIRANJE
<b>1722012</b>	ORMARIĆ ISPOD UMIVAONIKA RIO 55 BIJELI	550 x 375	M0004001	1
<b>1722013</b>	OGLEDALO-ORMARIĆ RIO 55 BIJELI	550 x 161	M0003938	1
<b>1722033</b>	UMIVAONIK SANOVIT LUXURY 11055	550 x 370	H0002008	1



SOFIA 80

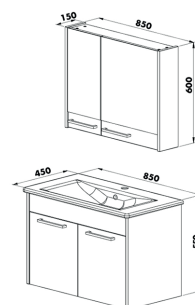

ŠIFRA VOKEL	OPIS	DIMENZIJE (mm)	ŠIFRA ARTIKLA	PAKIRANJE
<b>1722003</b>	ORMARIĆ ISPOD UMIVAONIKA SOFIA 80 PLAVI	850 x 450	M0003831	1
<b>1722004</b>	OGLEDALO-ORMARIĆ SOFIA 80 PLAVI	850 x 150	M0003850	1
<b>1722005</b>	BOČNI ORMARIĆ SOFIA TALL UNIT PLAVI	1400 x 350 x 300	M0003838	1
<b>1722095</b>	UMIVAONIK SANOVIT SOFT	800 x 450	H0000985	1

SOFIA 80

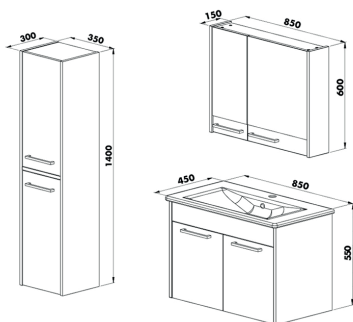

ŠIFRA VOKEL	OPIS	DIMENZIJE (mm)	ŠIFRA ARTIKLA	PAKIRANJE
<b>1722006</b>	ORMARIĆ ISPOD UMIVAONIKA SOFIA 80 TAMNO SIVI	850 x 450	M0003829	1
<b>1722007</b>	OGLEDALO-ORMARIĆ SOFIA 80 TAMNO SIVI	850 x 150	M0003852	1
<b>1722008</b>	BOČNI ORMARIĆ SOFIA TALL UNIT TAMNO SIVI	1400 x 350 x 300	M0003840	1
<b>1722095</b>	UMIVAONIK SANOVIT SIFT	800 x 450	H0000985	1

SOFIA 80

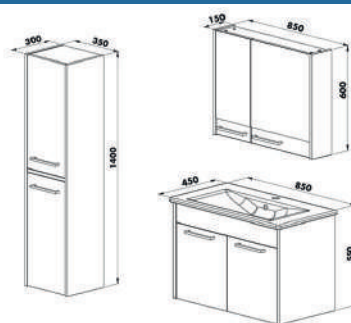

ŠIFRA VOKEL	OPIS	DIMENZIJE (mm)	ŠIFRA ARTIKLA	PAKIRANJE
<b>1722009</b>	ORMARIĆ ISPOD UMIVAONIKA SOFIA 80 ZELENI	850 x 450	M0003832	1
<b>1722010</b>	OGLEDALO-ORMARIĆ SOFIA 80 ZELENI	850 x 150	M0003849	1
<b>1722011</b>	BOČNI ORMARIĆ SOFIA TALL UNIT ZELENI	1400 x 350 x 300	M0003837	1
<b>1722095</b>	UMIVAONIK SANOVIT SOFT	800 x 450	H0000985	1

STRADA 55

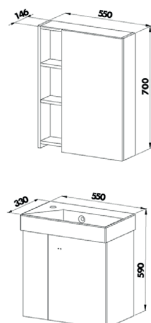

ŠIFRA VOKEL	OPIS	DIMENZIJE (mm)	ŠIFRA ARTIKLA	PAKIRANJE
<b>1722001</b>	ORMARIĆ ISPOD UMIVAONIKA STRADA BIJELI 55	550 x 330	M0002991	1
<b>1722002</b>	OGLEDALO-ORMARIĆ STRADA 55 BIJELI	550 x 146	M0002992	1
<b>1722031</b>	UMIVAONIK STANCE, SANOVIT 17055	550 x 330	H0001941	1





## VENNA 80

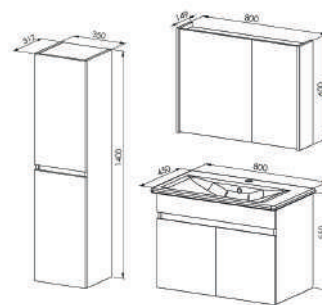

ŠIFRA VOKEL	OPIS	DIMENZIJE (mm)	ŠIFRA ARTIKLA	PAKIRANJE
<b>1722094</b>	ORMARIĆ ISPOD UMIVAONIKA VENNA 80 BIJELI	850 x 450	M0004393	1
<b>1722047</b>	OGLEDALO-ORMARIĆ VEGA 80 BIJELI	800 x 600	M0003300	1
<b>1722096</b>	BOČNI ORMARIĆ VENNA TALL UNIT BIJELI	1400 x 350 x 312	M0004463	1
<b>1722095</b>	UMIVAONIK SANOVIT SOFT	800 x 450	H0000985	1

## VENNA 65

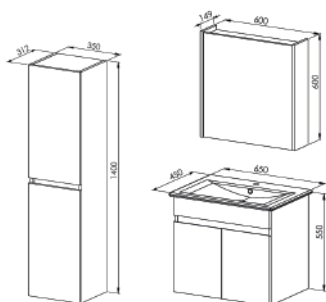

ŠIFRA VOKEL	OPIS	DIMENZIJE (mm)	ŠIFRA ARTIKLA	PAKIRANJE
<b>1722092</b>	ORMARIĆ ISPOD UMIVAONIKA VENNA 65 BIJELI	650 x 450	M0004391	1
<b>1722041</b>	OGLEDALO-ORMARIĆ VEGA 60 BIJELI	600 x 150	M0003299	1
<b>1722093</b>	UMIVAONIK SANOVIT SOFT	650 x 450	H0000984	1
<b>1722096</b>	BOČNI ORMARIĆ VENNA TALL UNIT BIJELI	1400 x 350 x 312	M0004463	1



## VENNA 55

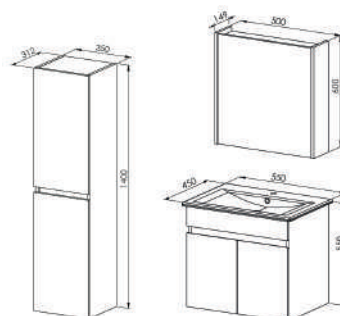

ŠIFRA VOKEL	OPIS	DIMENZIJE (mm)	ŠIFRA ARTIKLA	PAKIRANJE
<b>1722091</b>	ORMARIĆ ISPOD UMIVAONIKA VENNA 55 BIJELI	550 x 450	M0004389	1
<b>1722042</b>	OGLEDALO-ORMARIĆ VEGA 50 BIJELI	500 x 150	M0003298	1
<b>1722044</b>	UMIVAONIK SANOVIT ATRIA 9055	550 x 455	H0001664	1
<b>1722096</b>	BOČNI ORMARIĆ VENNA TALL UNIT BIJELI	1400 x 350 x 312	M0004463	1

PERA 45

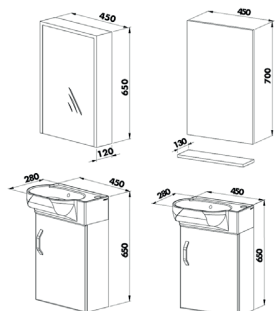

ŠIFRA VOKEL	OPIS	DIMENZIJE (mm)	ŠIFRA ARTIKLA	PAKIRANJE
<b>1722051</b>	ORMARIĆ ISPOD UMIVAONIKA PERA 45 BIJELI	450 x 280	M0004073	1
<b>1722050</b>	OGLEDALO-ORMARIĆ PERA 45 BIJELI		M0004104	1
<b>1722052</b>	UMIVAONIK SANOVIT 3045	450 x 280	H0001199	1



# elba



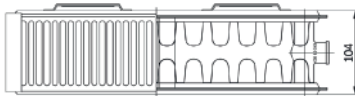

Kompaktni radijatori Tip 22 2 panela, 2konvektora					
		Vokel šifra			
		300	500	600	900
dužina (mm)	400				<b>1474020</b>
	500			<b>1474001</b>	
	600			<b>1474002</b>	<b>1474021</b>
	800			<b>1474003</b>	<b>1474022</b>
	1000	<b>1474016</b>	<b>1474010</b>	<b>1474004</b>	<b>1474023</b>
	1200	<b>1474017</b>	<b>1474011</b>	<b>1474005</b>	
	1400		<b>1474012</b>	<b>1474006</b>	
	1600	<b>1474018</b>	<b>1474013</b>	<b>1474007</b>	
	1800	<b>1474019</b>	<b>1474014</b>	<b>1474008</b>	
	2000		<b>1474015</b>	<b>1474009</b>	

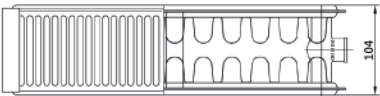
Ventilski radijatori Tip 22 2 panela, 2konvektora					
		Vokel šifra			
		300	500	600	900
dužina (mm)	400				<b>1473020</b>
	500			<b>1473001</b>	
	600			<b>1473002</b>	<b>1473021</b>
	800			<b>1473003</b>	<b>1473022</b>
	1000	<b>1473016</b>	<b>1473010</b>	<b>1473004</b>	<b>1473023</b>
	1200	<b>1473017</b>	<b>1473011</b>	<b>1473005</b>	
	1400		<b>1473012</b>	<b>1473006</b>	
	1600	<b>1473018</b>	<b>1473013</b>	<b>1473007</b>	
	1800	<b>1473019</b>	<b>1473014</b>	<b>1473008</b>	
	2000		<b>1473015</b>	<b>1473009</b>	

**Kompaktni radijatori Tip 22: 2 panela, 2konvektora**

ŠIFRA VOKEL	OPIS	PAKIRANJE (KOM/PAL)	DIMENZIJA	ART.
<b>1474001</b>	Radijator Elba-Smart kompakt	32	K22 H600 L500	1542112260050
<b>1474002</b>	Radijator Elba-Smart kompakt	32	K22 H600 L600	1542112260060
<b>1474003</b>	Radijator Elba-Smart kompakt	32	K22 H600 L800	1542112260080
<b>1474004</b>	Radijator Elba-Smart kompakt	32	K22 H600 L1000	1542112260100
<b>1474005</b>	Radijator Elba-Smart kompakt	32	K22 H600 L1200	1542112260120
<b>1474006</b>	Radijator Elba-Smart kompakt	32	K22 H600 L1400	1542112260140
<b>1474007</b>	Radijator Elba-Smart kompakt	26	K22 H600 L1600	1542112260160
<b>1474008</b>	Radijator Elba-Smart kompakt	26	K22 H600 L1800	1542112260180
<b>1474009</b>	Radijator Elba-Smart kompakt	26	K22 H600 L2000	1542112260200
<b>1474010</b>	Radijator Elba-Smart kompakt	16	K22 H500 L1000	1542112250100
<b>1474011</b>	Radijator Elba-Smart kompakt	16	K22 H500 L1200	1542112250120
<b>1474012</b>	Radijator Elba-Smart kompakt	16	K22 H500 L1400	1542112250140
<b>1474013</b>	Radijator Elba-Smart kompakt	13	K22 H500 L1600	1542112250160
<b>1474014</b>	Radijator Elba-Smart kompakt	13	K22 H500 L1800	1542112250180
<b>1474015</b>	Radijator Elba-Smart kompakt	13	K22 H500 L2000	1542112250200
<b>1474016</b>	Radijator Elba-Smart kompakt	-	K22 H300 L1000	1542112230100
<b>1474017</b>	Radijator Elba-Smart kompakt	-	K22 H300 L1200	1542112230120
<b>1474018</b>	Radijator Elba-Smart kompakt	-	K22 H300 L1600	1542112230160
<b>1474019</b>	Radijator Elba-Smart kompakt	-	K22 H300 L1800	1542112230180
<b>1474020</b>	Radijator Elba-Smart kompakt	16	K22 H900 L400	1542112290040
<b>1474021</b>	Radijator Elba-Smart kompakt	16	K22 H900 L600	1542112290060
<b>1474022</b>	Radijator Elba-Smart kompakt	16	K22 H900 L800	1542112290080
<b>1474023</b>	Radijator Elba-Smart kompakt	16	K22 H900 L1000	1542112290100

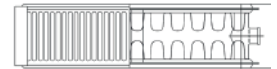

**Ventilski radijatori Tip 22: 2panela, 2konvektora**

ŠIFRA VOKEL	OPIS	PAKIRANJE (KOM/PAL)	DIMENZIJA	ART.
<b>1473001</b>	Radijator Elba-Smart ventilski	32	V22 H600 L500	1542642260050
<b>1473002</b>	Radijator Elba-Smart ventilski	32	V22 H600 L600	1542642260060
<b>1473003</b>	Radijator Elba-Smart ventilski	32	V22 H600 L800	1542642260080
<b>1473004</b>	Radijator Elba-Smart ventilski	32	V22 H600 L1000	1542642260100
<b>1473005</b>	Radijator Elba-Smart ventilski	32	V22 H600 L1200	1542642260120
<b>1473006</b>	Radijator Elba-Smart ventilski	32	V22 H600 L1400	1542642260140
<b>1473007</b>	Radijator Elba-Smart ventilski	26	V22 H600 L1600	1542642260160
<b>1473008</b>	Radijator Elba-Smart ventilski	26	V22 H600 L1800	1542642260180
<b>1473009</b>	Radijator Elba-Smart ventilski	26	V22 H600 L2000	1542642260200
<b>1473010</b>	Radijator Elba-Smart ventilski	16	V22 H500 L1000	1542642250100
<b>1473011</b>	Radijator Elba-Smart ventilski	16	V22 H500 L1200	1542642250120
<b>1473012</b>	Radijator Elba-Smart ventilski	16	V22 H500 L1400	1542642250140
<b>1473013</b>	Radijator Elba-Smart ventilski	13	V22 H500 L1600	1542642250160
<b>1473014</b>	Radijator Elba-Smart ventilski	13	V22 H500 L1800	1542642250180
<b>1473015</b>	Radijator Elba-Smart ventilski	13	V22 H500 L2000	1542642250200
<b>1473016</b>	Radijator Elba-Smart ventilski	-	V22 H300 L1000	1542642230100
<b>1473017</b>	Radijator Elba-Smart ventilski	-	V22 H300 L1200	1542642230120
<b>1473018</b>	Radijator Elba-Smart ventilski	-	V22 H300 L1600	1542642230160
<b>1473019</b>	Radijator Elba-Smart ventilski	-	V22 H300 L1800	1542642230180
<b>1473020</b>	Radijator Elba-Smart ventilski	16	V22 H900 L400	1542642290040
<b>1473021</b>	Radijator Elba-Smart ventilski	16	V22 H900 L600	1542642290060
<b>1473022</b>	Radijator Elba-Smart ventilski	16	V22 H900 L800	1542642290080
<b>1473023</b>	Radijator Elba-Smart ventilski	16	V22 H900 L1000	1542642290100

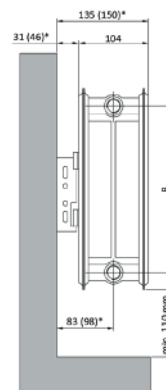
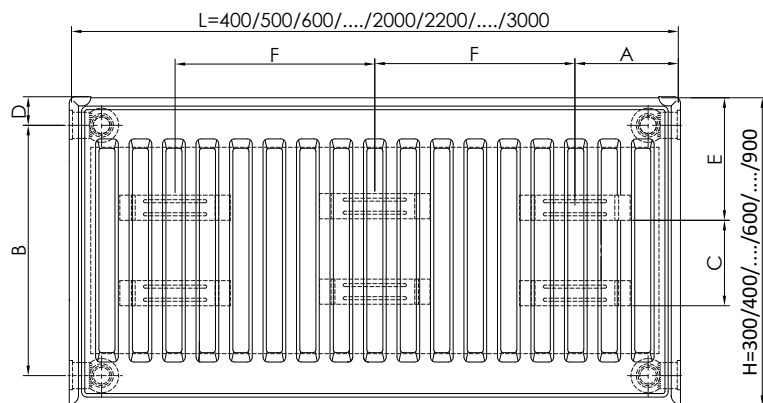
## Mjere za montažu radijatora

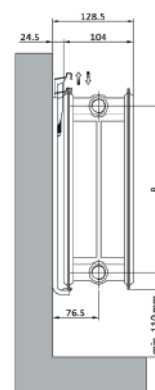

TIP :22-PKKP



TIP :22-PKKP

## Tehnički podaci

### DIMENZIJE PANELNIH RADIJATORA

TIP	11 - 21 - 22 - 33		
L (mm)	400-500-600...-2000-2200-...-3000	H (mm)	300-400-500-600-700-800-900
A (mm)	101 (Tip 11 = 117 mm)	B (mm)	249-349-449-549-649-749-849
C (mm)	85-185-285-385-485-585-685	D (mm)	26
E (mm)	120	F (mm)	(L - 2A) / 2

### BROJ DRŽAČA

L = 400-500-600-...-1600 mm	4 kom
L = 1700-1800-1900-...-3000	6 kom

### SPECIFIKACIJA I DEBLJINA MATERIJALA RADIJATORA

MATERIJAL	DEBLJINA	SPECIFIKACIJE (standard)
PANEL	1,15 mm	DIN EN 10130DC 01 QUALITY
KONVEKTOR	0,25 mm	DIN EN 10130 DC 01 QUALITY
POKLOPAC	0,60 mm	DIN EN 10130 DC 01 QUALITY
BOČNI POKLOPAC	0,50 mm	DIN EN 10130 DC 01 QUALITY

TIP	300		400		500		600		700		800		900	
	Težina kg/m	Volumen lt/m	Težina kg/m	Volumen lt/m	Težina kg/m	Volumen lt/m	Težina kg/m	Volumen lt/m	Težina kg/m	Volumen lt/m	Težina kg/m	Volumen lt/m	Težina kg/m	Volumen lt/m
11 (PK)	7,79	1,73	10,29	2,12	12,79	2,58	15,30	3,00	17,80	3,40	20,30	3,90	22,81	4,30
21 (PKP)	13,16	3,39	17,35	4,17	21,54	5,08	25,72	5,92	29,91	6,80	34,10	7,72	38,29	8,87
22 (PKKP)	14,60	3,42	19,28	4,22	23,96	5,13	28,63	5,97	33,31	6,84	37,99	7,77	42,67	8,92
33 (PKKPKP)	21,68	5,08	28,68	6,25	35,52	7,61	42,49	8,87	49,47	10,24	56,44	11,57	63,41	13,17

Visina (mm)	300	400	500	600	700	800	900
B mm	249	349	449	549	649	749	849
L <sub>11</sub> mm	400-3000	400-3000	400-3000	400-3000	400-3000	400-3000	400-3000
L <sub>21</sub> mm	400-3000	400-3000	400-3000	400-3000	400-3000	400-3000	400-3000
L <sub>22</sub> mm	400-3000	400-3000	400-3000	400-3000	400-3000	400-3000	400-3000
L <sub>33</sub> mm	400-3000	400-3000	400-3000	400-3000	400-2400	400-2000	400-1800



Dužina (mm)	Snaga (W)	Vokel šifra			
		300	500	600	900
400	75/65/20°C				<b>920</b>
	90/70/20°C				<b>1168</b>
500	75/65/20°C			<b>829</b>	
	90/70/20°C			<b>1051</b>	
600	75/65/20°C			<b>995</b>	<b>1379</b>
	90/70/20°C			<b>1261</b>	<b>1751</b>
800	75/65/20°C			<b>1326</b>	<b>1839</b>
	90/70/20°C			<b>1682</b>	<b>2335</b>
1000	75/65/20°C	<b>923</b>	<b>1425</b>	<b>1658</b>	<b>2299</b>
	90/70/20°C	<b>1177</b>	<b>1810</b>	<b>2102</b>	<b>2919</b>
1200	75/65/20°C	<b>1108</b>	<b>1710</b>	<b>1990</b>	
	90/70/20°C	<b>1412</b>	<b>2172</b>	<b>2522</b>	
1400	75/65/20°C		<b>1995</b>	<b>2321</b>	
	90/70/20°C		<b>2534</b>	<b>2943</b>	
1600	75/65/20°C	<b>1477</b>	<b>2280</b>	<b>2653</b>	
	90/70/20°C	<b>1883</b>	<b>2896</b>	<b>3363</b>	
1800	75/65/20°C	<b>1661</b>	<b>2565</b>	<b>2984</b>	
	75/65/20°C	<b>2119</b>	<b>3258</b>	<b>3784</b>	
2000	75/65/20°C		<b>2850</b>	<b>3316</b>	
	90/70/20°C		<b>3620</b>	<b>4204</b>	

# Aria

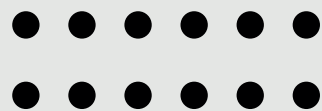



### MISTRAL

VORTEX ISPIRANJE - ISPIRANJE S JEDNOM RUPOM

ŠIFRA VOKEL	OPIS	ART.
<b>1731001</b>	VIŠEĆA WC ŠKOLJKA BEZ DASKE	KW-9003W
<b>1731002</b>	WC DASKA SOFTCLOSE	KW-9003W

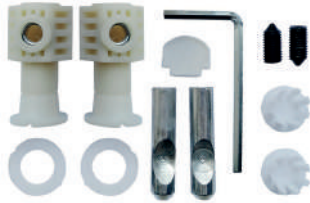
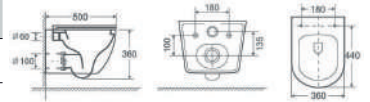

### REZERVNI VIJCI

ZA WC ŠKOLJKU

ŠIFRA VOKEL	OPIS	ART.
<b>1731003</b>	VIJCI ZA VIŠEĆU WC ŠKOLJKU MISTRAL	KW-827D



### REZERVNI VIJCI

ZA WC DASKU

ŠIFRA VOKEL	OPIS	ART.
<b>1731004</b>	VIJCI ZA WC DASKU MISTRAL	-



KALIOPA WHITE RIMLESS

ŠIFRA VOKEL	OPIS	ART.
<b>1724001</b>	VIŠEĆA WC ŠKOLJKA BEZ DASKE	B2342
<b>1724002</b>	WC DASKA SOFTCLOSE	051

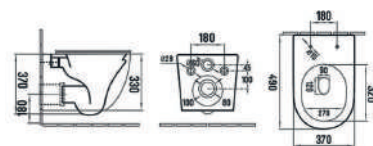

KALIOPA  
VIŠEĆI BIDE

ŠIFRA VOKEL	OPIS	ART.
<b>1724041</b>	VIŠEĆI BIDE - BIJELI	B2342BD



KALIOPA LIGHT GREY RIMLESS

ŠIFRA VOKEL	OPIS	ART.
<b>1724003</b>	VIŠEĆA WC ŠKOLJKA BEZ DASKE	B2342MH
<b>1724004</b>	WC DASKA SOFTCLOSE	051MH

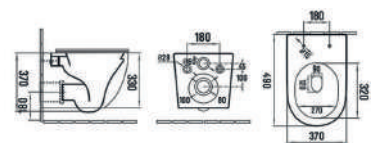

KALIOPA  
VIŠEĆI BIDE

ŠIFRA VOKEL	OPIS	ART.
<b>1724042</b>	VIŠEĆI BIDE LIGHT GREY MAT	B2342BDMH



KALIOPA CAPPUCCINO RIMLESS

VIŠEĆA WC ŠKOLJKA

ŠIFRA VOKEL	OPIS	ART.
<b>1724005</b>	VIŠEĆA WC ŠKOLJKA BEZ DASKE	B2342MC
<b>1724006</b>	WC DASKA SOFTCLOSE	051MC

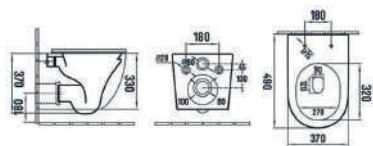





KALIOPA

VISEĆI BIDE

ŠIFRA VOKEL	OPIS	ART.
<b>1724043</b>	VISEĆI BIDE CAPPUCCINO MATT	B2342BDMC



KALIOPA BLACK RIMLESS

VISEĆA WC ŠKOLJKA

ŠIFRA VOKEL	OPIS	ART.
<b>1724007</b>	VISEĆA WC ŠKOLJKA BEZ DASKE	B2342MB
<b>1724008</b>	WC DASKA SOFTCLOSE	051MB

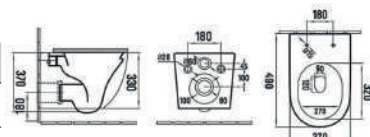

KALIOPA

VISEĆI BIDE

ŠIFRA VOKEL	OPIS	ART.
<b>1724044</b>	VISEĆI BIDE BLACK MATT	B2342BDMB



PENELOPA WHITE RIMLESS

VISEĆA WC ŠKOLJKA

ŠIFRA VOKEL	OPIS	ART.
<b>1724064</b>	VISEĆA WC ŠKOLJKA BEZ DASKE	B2351
<b>1724065</b>	WC DASKA SOFTCLOSE	068

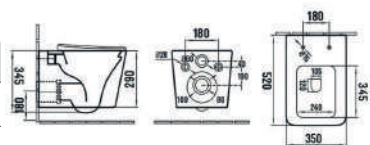

PENELOPA

VISEĆI BIDE

ŠIFRA VOKEL	OPIS	ART.
<b>1724079</b>	VISEĆI BIDE PENELOPA BIJELI	B2351BD





PENELOPA BLACK RIMLESS

VISEĆA WC ŠKOLJKA

ŠIFRA VOKEL	OPIS	ART.
<b>1724083</b>	VISEĆA WC ŠKOLJKA BEZ DASKE	B2351MB
<b>1724084</b>	WC DASKA SOFTCLOSE	068MB

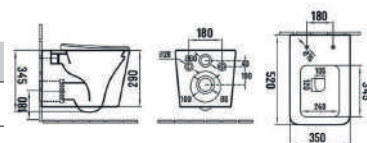

PENELOPA

VISEĆI BIDE

ŠIFRA VOKEL	OPIS	ART.
<b>1724085</b>	VISEĆI BIDE BLACK MATT	B2351BDMB



TALIJA WHITE RIMLESS

VISEĆA WC ŠKOLJKA

ŠIFRA VOKEL	OPIS	ART.
<b>1724039</b>	VISEĆA WC ŠKOLJKA BEZ DASKE	B2353
<b>1724040</b>	WC DASKA SOFTCLOSE	C050

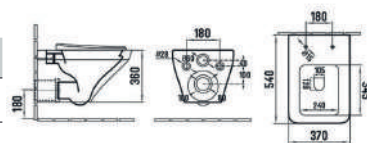

PISOAR CORAL WHITE

SA SENZOROM, SIFONOM, PILETOM I PRIBOROM ZA MONTAŽU

ŠIFRA VOKEL	OPIS	DIMENZIJA (cm)	NAPAJANJE	ART.
<b>1724076</b>	PISOAR CORAL WHITE	34x37x78	BATERIJSKO	X571-S



PISOAR CORAL WHITE

SA SIFONOM, KERAMIČKIM POKROVOM I PRIBOROM ZA MONTAŽU

ŠIFRA VOKEL	OPIS	DIMENZIJA (cm)	ART.
<b>1724077</b>	PISOAR CORAL WHITE	34x37x78	X571



### PISOAR CORAL BLACK

SA SIFONOM, KERAMIČKIM POKROVOM I PRIBOROM ZA MONTAŽU

ŠIFRA VOKEL	OPIS	DIMENZIJA (cm)	ART.
<b>1724087</b>	PISOAR CORAL BLACK	34X37X78	X571MB



### MAK

WC ČUČAVAC

ŠIFRA VOKEL	OPIS	DIMENZIJA (cm)	ART.
<b>1724078</b>	WC ČUČAVAC MAK WHITE	52x42x19	105



### REZERVNI VIJCI

ZA WC ŠKOLJKU

ŠIFRA VOKEL	OPIS	ART.
<b>1724037</b>	VIJCI ZA WC ŠKOLJKU KALIOPA, PENELOPA I TALIJA	BS-1



### REZERVNI VIJCI

ZA WC DASKU

ŠIFRA VOKEL	OPIS	ART.
<b>1724038</b>	VIJCI ZA WC DASKU KALIOPA I PENELOPA	051-S



### REZERVNI VIJCI

ZA WC DASKU

ŠIFRA VOKEL	OPIS	ART.
<b>1724066</b>	VIJCI ZA WC DASKU TALIJA	C050-S



### RASPRŠIVAČ ZA PISOAR CORAL

SA SENZOROM

ŠIFRA VOKEL	OPIS	ART.
<b>1724096</b>	RASPRŠIVAČ SA SENZOROM ZA PISOAR CORAL(1724076)	X571-S SPRAYER

## KERAMIČKI POKROV ZA PISOAR BLACK CORAL



ŠIFRA VOKEL	OPIS	ART.
<b>1724091</b>	KERAMIČKI POKROV ZA PISOAR BLACK CORAL (1724087)	X571MB CERAMIC COVER

## KERAMIČKI POKROV ZA PISOAR WHITE CORAL



ŠIFRA VOKEL	OPIS	ART.
<b>1724086</b>	KERAMIČKI POKROV ZA PISOAR WHITE CORAL (1724076, 1724077)	X571 CERAMIC COVER

## KUĆIŠTE ZA BATERIJU ZA PISOAR CORAL

SA SENZOROM



ŠIFRA VOKEL	OPIS	ART.
<b>1724090</b>	RASPRŠIVAČ SA SENZOROM ZA PISOAR CORAL (1724076)	X571-S BATTERY BOX

## SIFON ZA PISOAR CORAL



ŠIFRA VOKEL	OPIS	ART.
<b>1724088</b>	SIFON ZA PISOAR CORAL 1724076, 1724077, 1724087	X571 P-TRAP FITTING

## VENTIL ZA PISOAR CORAL

SA SENZOROM



ŠIFRA VOKEL	OPIS	ART.
<b>1724093</b>	VENTIL SA SENZOROM ZA PISOAR CORAL (1724076)	X571-S SENSOR VALVE

## ULAZNA CIJEV ZA PISOAR CORAL

SA SENZOROM



ŠIFRA VOKEL	OPIS	ART.
<b>1724094</b>	ULAZNA CIJEV ZA PISOAR CORAL SA SENZOROM (1724076)	X571-S INLET PIPE

ULAZNA CIJEV ZA PISOAR CORAL



ŠIFRA VOKEL	OPIS	ART.
<b>1724095</b>	ULAZNA CIJEV ZA PISOAR CORAL (1724077, 1724087)	X571 INLET PIPE

PRETVARAČ ZA PISOAR CORAL

SA SENZOROM



ŠIFRA VOKEL	OPIS	ART.
<b>1724097</b>	PRETVARAČ ZA PISOAR CORAL SA SENZOROM (1724076)	X571-S TRANSFORMER

SENZOR ZA PISOAR CORAL



ŠIFRA VOKEL	OPIS	ART.
<b>1724089</b>	SENZOR ZA PISOAR CORAL SA SENZOROM (1724076)	X571-S SENSOR

REZERVNI VIJCI

ZA PISOAR CORAL



ŠIFRA VOKEL	OPIS	ART.
<b>1724092</b>	VIJCI ZA PISOAR CORAL (1724076, 1724077, 1724087)	X571 WALL HUNG FITTING



GEA WHITE

NADPULTNI 60x40 cm

ŠIFRA VOKEL	BOJA	DIMENZIJA (cm)	ART.
<b>1724009</b>	BIJELI	60x40	78239



GEA LIGHT GREY S PILETOM U ISTOJ BOJI

NADPULTNI 60x40 cm

ŠIFRA VOKEL	BOJA	DIMENZIJA (cm)	ART.
<b>1724010</b>	LIGHT GREY	60x40	78239MH



GEA BROWN S PILETOM U ISTOJ BOJI

NADPULTNI 60x40 cm

ŠIFRA VOKEL	BOJA	DIMENZIJA (cm)	ART.
<b>1724011</b>	BROWN	60x40	78239MDB



GEA CAPPUCCINO S PILETOM U ISTOJ BOJI

NADPULTNI 60x40 cm

ŠIFRA VOKEL	BOJA	DIMENZIJA (cm)	ART.
<b>1724012</b>	CAPPUCCINO	60x40	78239MC



GEA DARK GREEN S PILETOM U ISTOJ BOJI

NADPULTNI 60x40 cm

ŠIFRA VOKEL	BOJA	DIMENZIJA (cm)	ART.
<b>1724013</b>	DARK GREEN	60x40	78239MDG



GEA BLACK S PILETOM U ISTOJ BOJI

NADPULTNI 60x40 cm

ŠIFRA VOKEL	BOJA	DIMENZIJA (cm)	ART.
<b>1724014</b>	BLACK	60x40	78239MB





### NUBIA WHITE

NADPULTNI 50x39

ŠIFRA VOKEL	BOJA	DIMENZIJA (cm)	ART.
<b>1724031</b>	WHITE	50x39	78109
<b>1724073</b>	MATT WHITE	50x39	78109MW



### NUBIA DARK GREEN S PILETOM U ISTOJ BOJI

NADPULTNI 59x39

ŠIFRA VOKEL	BOJA	DIMENZIJA (cm)	ART.
<b>1724032</b>	DARK GREEN	50x39	78109MDG



### NUBIA LIGHT GREY S PILETOM U ISTOJ BOJI

NADPULTNI 50x39 cm

ŠIFRA VOKEL	BOJA	DIMENZIJA (cm)	ART.
<b>1724033</b>	LIGHT GREY	50x39	78109MH



### NUBIA BROWN S PILETOM U ISTOJ BOJI

NADPULTNI 50x39 cm

ŠIFRA VOKEL	BOJA	DIMENZIJA (cm)	ART.
<b>1724034</b>	BROWN	50x39	78109MDB



### NUBIA CAPPUCCINO S PILETOM U ISTOJ BOJI

NADPULTNI 50x39 cm

ŠIFRA VOKEL	BOJA	DIMENZIJA (cm)	ART.
<b>1724035</b>	CAPPUCCINO	50x39	78109MC



### NUBIA BLACK S PILETOM U ISTOJ BOJI

NADPULTNI 50x39 cm

ŠIFRA VOKEL	BOJA	DIMENZIJA (cm)	ART.
<b>1724036</b>	BLACK	50x39	78109MB



SWAN GOLD/BLUE

NADPULTNI Ø 40,5

ŠIFRA VOKEL	BOJA	DIMENZIJA (Ø)	ART.
<b>1724016</b>	GOLD/BLUE	40,5	J2111



TANA BLACK/BRONZE

NADPULTNI Ø 43,5

ŠIFRA VOKEL	BOJA	DIMENZIJA (Ø)	ART.
<b>1724017</b>	BLACK/BRONZE	43,5	J2091

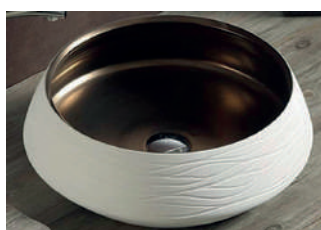

TANA WHITE/BRONZE

NADPULTNI Ø 41

ŠIFRA VOKEL	BOJA	DIMENZIJA (Ø)	ART.
<b>1724018</b>	WHITE/BRONZE	41	J2094

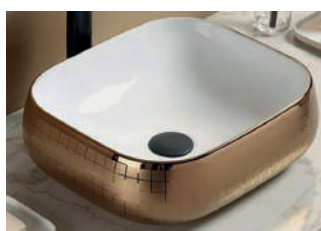

ONTARIO GOLD/WHITE

NADPULTNI 45x40 cm

ŠIFRA VOKEL	BOJA	DIMENZIJA (cm)	ART.
<b>1724019</b>	GOLD/WHITE	45x40	78322



BROA WHITE

NADPULTNI 60x38 cm

ŠIFRA VOKEL	BOJA	DIMENZIJA (cm)	ART.
<b>1724020</b>	WHITE	60x38	C1098



CEDAR STATUARIO

NADPULTNI 45,5x32,5 cm

ŠIFRA VOKEL	BOJA	DIMENZIJA (cm)	ART.
<b>1724021</b>	STATUARIO	45,5x32,5	C1013



CEDAR CALACATTA

NADPULTNI 45,5x32,5 cm

ŠIFRA VOKEL	BOJA	DIMENZIJA (cm)	ART.
<b>1724022</b>	CALACATTA	45,5x32,5	C1012



## EVORON WHITE

NADPULTNI 65x33,5

ŠIFRA VOKEL	BOJA	DIMENZIJA (cm)	ART.
<b>1724023</b>	WHITE	65x33,5	7756B



## IBERA WHITE

NADPULTNI 60x40

ŠIFRA VOKEL	BOJA	DIMENZIJA (cm)	ART.
<b>1724024</b>	WHITE	60x40	7680



## LA PLATA WHITE

NADPULTNI 59x38

ŠIFRA VOKEL	BOJA	DIMENZIJA (cm)	ART.
<b>1724025</b>	WHITE	59x38	78390



## NASSER WHITE

NADPULTNI 72,5x37 cm

ŠIFRA VOKEL	BOJA	DIMENZIJA (cm)	ART.
<b>1724026</b>	WHITE	72,5x37	7811B



## SEUL BLACK S PILETOM U ISTOJ BOJI

NADPULTNI 52x39,5 cm

ŠIFRA VOKEL	BOJA	DIMENZIJA (cm)	ART.
<b>1724027</b>	BLACK	52x39,5	78166MMB



## ROSANA LIGHT GREY S PILETOM U ISTOJ BOJI

NADPULTNI 60x41,5

ŠIFRA VOKEL	BOJA	DIMENZIJA (cm)	ART.
<b>1724030</b>	LIGHT GREY	60x41,5	78326MH



## ROSANA WHITE MATT

NADPULTNI 60x41,5 cm

ŠIFRA VOKEL	BOJA	DIMENZIJA (cm)	ART.
<b>1724072</b>	WHITE	60x41,5	78326MW



ROSANA BLACK S PILETOM U ISTOJ BOJI

NADPULTNI 60x41,5 cm

ŠIFRA VOKEL	BOJA	DIMENZIJA (cm)	ART.
<b>1724028</b>	BLACK	60x41,5	78326MB

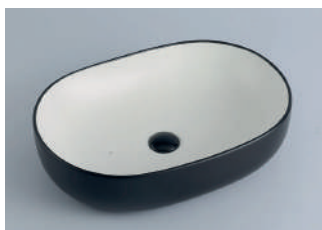

ROSANA BLACK/WHITE

NADPULTNI 60x41,5 cm

ŠIFRA VOKEL	BOJA	DIMENZIJA (cm)	ART.
<b>1724029</b>	BLACK/WHITE	60x41,5	78326MBW



TUMBA WHITE

LJJEVI 40,5x28 cm

ŠIFRA VOKEL	BOJA	DIMENZIJA (cm)	ART.
<b>1724045</b>	WHITE	40,5x28	78404L



TUMBA WHITE

DESNI 40,5x28 cm

ŠIFRA VOKEL	BOJA	DIMENZIJA (cm)	ART.
<b>1724046</b>	WHITE	40,5x28	78404R



OHRID BLACK

NADPULTNI 61x35 cm

ŠIFRA VOKEL	BOJA	DIMENZIJA (cm)	ART.
<b>1724047</b>	BLACK	61x35	78626



TRIBIS WHITE

NADPULTNI Ø39

ŠIFRA VOKEL	BOJA	DIMENZIJA (ø)	ART.
<b>1724048</b>	WHITE	39	112D
<b>1724074</b>	MATT WHITE	39	112DMW



COMO WHITE

NADPULTNI Ø36

ŠIFRA VOKEL	BOJA	DIMENZIJA (ø)	ART.
<b>1724049</b>	WHITE	36	78435



### URMIA STONE

NADPULTNI 50,5x38 cm

ŠIFRA VOKEŁ	BOJA	DIMENZIJA (cm)	ART.
<b>1724050</b>	STONE	50,5x38	C78328M-Y1



### LUGANO WHITE/SILVER

NADPULTNI 50,5x40,5 cm

ŠIFRA VOKEŁ	BOJA	DIMENZIJA (cm)	ART.
<b>1724051</b>	WHITE/SILVER	50,5x40,5	C1071



### ARAL WHITE

STOJEĆI 40x40x83 cm

ŠIFRA VOKEŁ	BOJA	DIMENZIJA (cm)	ART.
<b>1724052</b>	WHITE	40x40x83	B169-1



### LAGUNA WHITE

STOJEĆI 46x44x82 cm

ŠIFRA VOKEŁ	BOJA	DIMENZIJA (cm)	ART.
<b>1724053</b>	WHITE	46x44x82	B135-1



### KRISTALL WHITE

NADPULTNI Ø36

ŠIFRA VOKEŁ	BOJA	DIMENZIJA (Ø)	ART.
<b>1724054</b>	WHITE	36	GL01



### KRISTALL BLACK

NADPULTNI Ø36

ŠIFRA VOKEŁ	BOJA	DIMENZIJA (Ø)	ART.
<b>1724055</b>	BLACK	36	GL03





KRISTALL GOLD

NADPULTNI Ø36

ŠIFRA VOKEL	BOJA	DIMENZIJA (ø)	ART.
<b>1724056</b>	GOLD	36	GL05



HANNA GOLD

NADPULTNI Ø40,5

ŠIFRA VOKEL	BOJA	DIMENZIJA (ø)	ART.
<b>1724057</b>	GOLD	40,5	7078AJ



NESSY WHITE

NADPULTNI 50, 60, 70 cm

ŠIFRA VOKEL	BOJA	DIMENZIJA (cm)	ART.
<b>1724058</b>	WHITE	50,5x38	78575B(50)
<b>1724059</b>	WHITE	61x38	78575B(60)
<b>1724060</b>	WHITE	70,5x38	78575B(70)



NESSY BLACK

NADPULTNI 50, 60, 70 cm

ŠIFRA VOKEL	BOJA	DIMENZIJA (cm)	ART.
<b>1724061</b>	BLACK	50,5x38	78575B(50)MB
<b>1724062</b>	BLACK	61x38	78575B(60)MB
<b>1724063</b>	BLACK	70,5x38	78575B(70)MB



URI MULTICOLOR

NADPULTNI 60x41,5 cm

ŠIFRA VOKEL	BOJA	DIMENZIJA (cm)	ART.
<b>1724067</b>	MULTICOLOR	60x41,5	C78326M-W21



FORMOSA WHITE

NADPULTNI 45,5x32,5 cm

ŠIFRA VOKEL	BOJA	DIMENZIJA (cm)	ART.
<b>1724068</b>	WHITE	40,5x32,5	78105



## TEMPE WHITE

NADPULTNI 60x42,5 cm

ŠIFRA VOKEL	BOJA	DIMENZIJA (cm)	ART.
<b>1724069</b>	WHITE	60x42,5	78188



## SALDA BLACK

NADPULTNI Ø41,5

ŠIFRA VOKEL	BOJA	DIMENZIJA (Ø)	ART.
<b>1724070</b>	BLACK	41,5	78115MB



## ISEO

NADPULTNI 50,4x35,2

ŠIFRA VOKEL	BOJA	DIMENZIJA (cm)	ART.
<b>1724075</b>	WHITE	50,4x35,2	78589



## KARIBA

VISEĆI / NADPULTNI 50x35

ŠIFRA VOKEL	BOJA	DIMENZIJA (cm)	ART.
<b>1724080</b>	WHITE	50x35	7657D



## VIDA

VISEĆI / NADPULTNI 50x38,5

ŠIFRA VOKEL	BOJA	DIMENZIJA (cm)	ART.
<b>1724081</b>	WHITE	50x38,5	78363



## TAY

VISEĆI / NADPULTNI 40x30

ŠIFRA VOKEL	BOJA	DIMENZIJA (cm)	ART.
<b>1724082</b>	WHITE	40x30	7440C

# ALATI I PRIBOR ZA KERAMIČARE

 **BIHUI**



**RUČNI REZAČ KERAMIKE TCM**



ŠIFRA VOKEL	DUŽINA (mm)	ART.
<b>1670115</b>	700	27187
<b>1670116</b>	900	28038
<b>1670117</b>	1200	28039
<b>1670118</b>	1650	28043

**PRIČUVNI NOŽIĆ TCM-SW**

ŠIFRA VOKEL	DUBINA REZANJA (mm)	ART.
<b>1670119</b>	16	28064

**DIJAMANTNA BRUSNO - REZNA PLOČA**

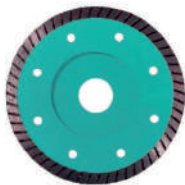
ŠIFRA VOKEL	VELIČINA (mm)	ART.
<b>1670001</b>	125	47801

**DIJAMANTNA REZNA PLOČA**

ŠIFRA VOKEL	VELIČINA (mm)	ART.
<b>1670002</b>	115x1,4	47798

**DIJAMANTNA REZNA PLOČA**

ŠIFRA VOKEL	VELIČINA (mm)	ART.
<b>1670108</b>	115x1,4	47797

**DIJAMANTNA REZNA PLOČA B-MASTER**

ŠIFRA VOKEL	VELIČINA (mm)	ART.
<b>1670003</b>	115x1,2	47799





### DIJAMANTNA REZNA PLOČA BEZ PROREZA

ŠIFRA VOKEŁ	VELIČINA (mm)	ART.
<b>1670029</b>	115x1,8	4938



### DIJAMANTNA REZNA PLOČA S PROREZOM

ŠIFRA VOKEŁ	VELIČINA (mm)	ART.
<b>1670030</b>	115x1,8	4936



### PLOČA ZA POLIRANJE

ŠIFRA VOKEŁ	VELIČINA (mm)	ART.
<b>1670098</b>	125x2	23580



### REZNO - BRUSNA PLOČA

ŠIFRA VOKEŁ	VELIČINA (mm)	ART.
<b>1670101</b>	50	48770

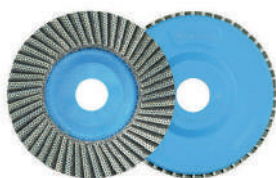

### DIJAMANTNI LAMELARNI BRUSNI DISK

ŠIFRA VOKEŁ	GRIT (GR)	VELIČINA (mm)	ART.
<b>1670121</b>	60	115 mm	48775

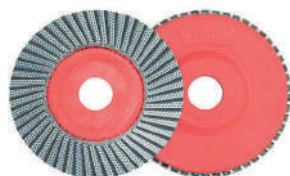

### DIJAMANTNI LAMELARNI BRUSNI DISK

ŠIFRA VOKEŁ	GRIT (GR)	VELIČINA (mm)	ART.
<b>1670122</b>	200	115 mm	48776



### DIJAMANTNA KRUNA SET 4u1

ŠIFRA VOKEŁ	VELIČINA (mm)	ART.
<b>1670004</b>	25 - 40 - 60 - 70	47845



**DIJAMANTNA KRUNA ZA BUŠILICU**

ŠIFRA VOKEL	VELIČINA (mm)	ART.
<b>1670017</b>	6	47893
<b>1670020</b>	8	47894
<b>1670007</b>	10	47895
<b>1670010</b>	12	47896

**DIJAMANTNA KRUNA M14**

ŠIFRA VOKEL	VELIČINA (mm)	ART.
<b>1670057</b>	6	8446
<b>1670019</b>	8	7887
<b>1670006</b>	10	7888
<b>1670009</b>	12	47897
<b>1670011</b>	20	7889
<b>1670012</b>	30	7890
<b>1670013</b>	35	7891
<b>1670014</b>	40	7908
<b>1670015</b>	45	7892
<b>1670016</b>	60	7893
<b>1670064</b>	65	48802
<b>1670058</b>	70	7894
<b>1670018</b>	82	7895
<b>1670005</b>	100	47898
<b>1670008</b>	115	47899

**KRUNA ZA PROŠIRENJE**



ŠIFRA VOKEL	VELIČINA (mm)	ART.
<b>1670097</b>	20	48773

**KRUNA ZA PROŠIRENJE**

ŠIFRA VOKEL	VELIČINA (mm)	ART.
<b>1670099</b>	2-38	48774

**VOSAK ZA DIJAMANTNE KRUNE**

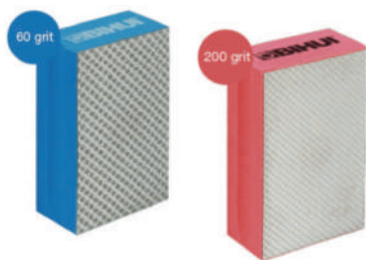
ŠIFRA VOKEL	VELIČINA (ml)	ART.
<b>1670067</b>	20	48767



### DIJAMANTNA BRUSNA SPUŽVICA

ŠIFRA VOKEL	GRIT (GR)	ART.
<b>1670062</b>	200	48772
<b>1670063</b>	60	48771



### VAKUMSKA VODILICA

ŠIFRA VOKEL	PAKIRANJE	ART.
<b>1670023</b>	1	47821



### VAKUMSKI NOSAČ - DVOSTRUKI

ŠIFRA VOKEL	PAKIRANJE	ART.
<b>1670024</b>	1	47796



### VAKUMSKI NOSAČ - JEDNOSTRUKI

ŠIFRA VOKEL	PAKIRANJE	ART.
<b>1670025</b>	1	47795



### VIBRACIJSKI VAKUM ZA PLOČE

ŠIFRA VOKEL	KAPACITET DIZANJA (kg)	ART.
<b>1670084</b>	35	47844



### VAKUMSKI NOSAČ - ZA GRUBE POVRŠINE SA PUMPOM I REGULACIJOM PRITISKA

ŠIFRA VOKEL	KAPACITET DIZANJA (kg)	ART.
<b>1670093</b>	110	48028



## KUTNI VAKUMSKI REGULATOR RAZMAKA PLOČICA

ŠIFRA VOKEL	DIMENZIJA VAKUMA (")	ART.
<b>1670111</b>	6"	21221



## PODESIVI REGULATOR VISINE

ŠIFRA VOKEL	MAX. NOSIVOST (kg)	ART.
<b>1670053</b>	105	47819



## ŠABLON VIŠENAMJENSKI

ŠIFRA VOKEL	ART.
<b>1670065</b>	47849



## ŠABLON ZA POZICIONIRANJE RUPA

ŠIFRA VOKEL	ART.
<b>1670066</b>	48768



## SET GLETERA

ŠIFRA VOKEL	KOM/SET	ART.
<b>1670021</b>	8	47823



## IZMJENJIVA DRŠKA ZA SET GLETERA

ŠIFRA VOKEL	ART.
<b>1670104</b>	48027



## GLETER NAZUBLJENI ROSTFREI

ŠIFRA VOKEL	VELIČINA (mm)	ART.
<b>1670036</b>	280x130x6	4819
<b>1670034</b>	280x130x8	22611
<b>1670033</b>	280x130x10	22612
<b>1670037</b>	280x130x12	22622



## IZMJENJIVA OŠTRICA ZA IZMJENJIVU DRŠKU

ŠIFRA VOKEL	VELIČINA (mm)	ART.
<b>1670105</b>	280x115x4	48793
<b>1670106</b>	280x115x10	20883
<b>1670107</b>	280x115x12	48794



## GLETER NAZUBLJENI ROSTFREI

ŠIFRA VOKEL	VELIČINA (mm)	ART.
<b>1670035</b>	480x130x10	4823



## GLETER NAZUBLJENI

ŠIFRA VOKEL	VELIČINA (mm)	ART.
<b>1670074</b>	280x120x10	48783
<b>1670075</b>	280x120x12	48784



## GLETER RAVNI

ŠIFRA VOKEL	VELIČINA (mm)	ART.
<b>1670100</b>	280x120	48813



## GLETER NAZUBLJENI

ŠIFRA VOKEL	VELIČINA (mm)	ART.
<b>1670076</b>	320x120x10	48785
<b>1670077</b>	320x120x12	48786



**GLETER ZA FUGIRANJE**

ŠIFRA VOKEL	VELIČINA (mm)	ART.
<b>1670086</b>	95x240	39336



**ŠIPKA ZA MJEŠANJE - SDS PRIHVAT**

ŠIFRA VOKEL	VELIČINA (mm)	ART.
<b>1670043</b>	100x600	37889
<b>1670044</b>	80x400	37888



**ŠIPKA ZA MJEŠANJE S NAVOJEM**

ŠIFRA VOKEL	VELIČINA (mm)	ART.
<b>1670061</b>	130 - 600	22476



**ŠIPKA ZA MJEŠANJE TWIST**

ŠIFRA VOKEL	VELIČINA (mm)	ART.
<b>1670082</b>	140 x600	48804



**ŽLICA GIPSERSKA**

ŠIFRA VOKEL	VELIČINA (mm)	ART.
<b>1670051</b>	120	1011



**ŽLICA ZIDARSKA**

ŠIFRA VOKEL	VELIČINA (mm)	ART.
<b>1670052</b>	160	16216





### ŽLICA KVADRATNA

ŠIFRA VOKEL	VELIČINA (mm)	ART.
<b>1670085</b>	160	48021



### ŠPAHTLA - LOPATICA

ŠIFRA VOKEL	VELIČINA (mm)	ART.
<b>1670045</b>	50	20767
<b>1670046</b>	75	20768
<b>1670047</b>	100	20769



### SET POSUDA - VALJAK + TOČKIĆI

ŠIFRA VOKEL	VOLUMEN (l)	ART.
<b>1670039</b>	20	22477



### POSUDA ZA FUGIRANJE

ŠIFRA VOKEL	VOLUMEN (l)	ART.
<b>1670080</b>	19	48766



### GLETER SPUŽVA - BIJELA 910 S

ŠIFRA VOKEL	VELIČINA (mm)	ART.
<b>1670031</b>	280x140x30	26628



### GLETER SPUŽVA - BIJELA 910 ST NAREZANA

ŠIFRA VOKEL	VELIČINA (mm)	ART.
<b>1670032</b>	280x140x30	16109

**SPUŽVA**

ŠIFRA VOKEŁ	VELIČINA (mm)	ART.
<b>1670041</b>	130x140x65	2834
<b>1670042</b>	275x140x65	2835

**NIVELIR SISTEM**

ŠIFRA VOKEŁ	VELIČINA (mm)	ART.
<b>1670096</b>	12-20	15497.1

**BAZA ZA NIVELIRANJE**

ŠIFRA VOKEŁ	VELIČINA (mm)	ART.
<b>1670102</b>	1,5	15502.2
<b>1670103</b>	1	15499.2

**LOPATICA ZA SILIKON**

ŠIFRA VOKEŁ	ART.
<b>1670078</b>	48788

**STRUGAČ ZA FUGE I ZAMJENSKI NOŽ**

ŠIFRA VOKEŁ	VELIČINA (mm)	ART.
<b>1670081</b>	50	47846
<b>1670083</b>	-	47847



## STRUGAČ ZA STAKLO +5 PRIČUVNIH NOŽIČA

ŠIFRA VOKEL	PAK/KOM	ART.
<b>1670089</b>	6	47725



## PRIČUVNI NOŽIĆ

ŠIFRA VOKEL	VELIČINA (mm)	ART.
<b>1670088</b>	18	47580



## KLIJEŠTA ZA NIVELIRANJE

ŠIFRA VOKEL	ART.
<b>1670060</b>	15514



## KLIJEŠTA ZA PORCULANSKE PLOČE

ŠIFRA VOKEL	ART.
<b>1670092</b>	48026



## SET ZA RAD SA SILIKONIMA

ŠIFRA VOKEL	PAK/KOM	ART.
<b>1670022</b>	3	47848



## GUMENI ČEKIĆ

ŠIFRA VOKEL	VELIČINA (mm)	ART.
<b>1670027</b>	55	4968
<b>1670028</b>	75	4969

**PIŠTOLJ ALUMINIJSKI ZA MASE**

ŠIFRA VOKEL	KAPACITET (ml)	ART.
<b>1670087</b>	320	1221

**PIŠTOLJ ZA PUR PJENU**

ŠIFRA VOKEL	SNAGA (kg)	ART.
<b>1670113</b>	9	28112

**PIŠTOLJ ZA PUR PJENU PTFE**

ŠIFRA VOKEL	MATERIJAL	ART.
<b>1670114</b>	TEFLON	11659

**ŠTITNICI ZA KOLJENA**

ŠIFRA VOKEL	VELIČINA (mm)	ART.
<b>1670048</b>	150x150x20	271
<b>1670049</b>	150x170x20	34895

**TULJAK ZA FUGIRANJE**

ŠIFRA VOKEL	ART.
<b>1670050</b>	14428

**KAJLA - VELIKA/MALA**

ŠIFRA VOKEL	PAKIRANJE (kom)	ART.
<b>1670069</b>	100	9744
<b>1670070</b>	50	12106



## SKALPEL S METALNOM VODILICOM

ŠIFRA VOKEŁ	VELIČINA (mm)	ART.
<b>1670040</b>	max 18	290



## PRIČUVNI NOŽIĆ ZA SKALPEL

ŠIFRA VOKEŁ	VELIČINA (mm)	ART.
<b>1670038</b>	18	294



## SKALPEL SILVER PROFY

ŠIFRA VOKEŁ	VELIČINA (mm)	ART.
<b>1670072</b>	18	20460



## LIBELA PT

ŠIFRA VOKEŁ	VELIČINA (mm)	ART.
<b>1670055</b>	200	33114



## LIBELA PTM 5 - MAGNETNA

ŠIFRA VOKEŁ	VELIČINA (mm)	ART.
<b>1670056</b>	200	33115



## DRVENI DVOMETAR

ŠIFRA VOKEŁ	VELIČINA (mm)	ART.
<b>1670068</b>	2000	16594





ROLNI METAR

ŠIFRA VOKEL	VELIČINA (mm)	ART.
<b>1670109</b>	5000x25	47885



KUTNIK

ŠIFRA VOKEL	VELIČINA (mm)	ART.
<b>1670090</b>	350	5018



ALUMINIJSKI KUTNIK

ŠIFRA VOKEL	VELIČINA (mm)	ART.
<b>1670110</b>	500	47658



OLOVKA ZA SJAJNE POVRŠINE

ŠIFRA VOKEL	ART.
<b>1670071</b>	16630



TERSARSKI MARKER

ŠIFRA VOKEL	ART.
<b>1670073</b>	47878



KREP TRAKA - PAPIRNATA

ŠIFRA VOKEL	VELIČINA (mm)	ART.
<b>1670094</b>	30-50	34887
<b>1670095</b>	50-50	34889



## TCM7 - OLOVKA ZA OZNAČAVANJE

ŠIFRA VOKEL	PAKIRANJE (kom)	ART.
<b>1670112</b>	6	53070



## ULOŽAK OLOVKE ZA OZNAČAVANJE TCM7-SL

ŠIFRA VOKEL	PAKIRANJE (kom)	ART.
<b>1670120</b>	6	319



## CLM30 - UŽE ZA POVLAČENJE LINIJA

ŠIFRA VOKEL	PAKIRANJE (kom)	DUŽINA (m)	ART.
<b>1670123</b>	1	30	38657



## PRAH ZA OBILJEŽAVANJE

ŠIFRA VOKEL	PAKIRANJE (kom)	TEŽINA (g)	BOJA	ART.
<b>1670124</b>	1	230	crvena	12155
<b>1670125</b>	1	230	plava	12166



# KATALOG PROIZVODA

BUILDING TRUST





## Sika® MonoSeal 101 - UNUTARNJA HIDROIZOLACIJA

- » Djelotvorna, ekonomična hidroizolacija postojećih objekata
- » Jednostavna primjena četkom
- » Sprječavanje prodora podzemne vode ili sprječavanje otjecanja stajaće ili tekuće vode u građevinskim hidrotehničkim konstrukcijama
- » Pogodan za hidroizolaciju spremnika pitke vode
- » Potrošnja: približno ~ 1.9 kg/m<sup>2</sup>/mm

VOKEL ŠIFRA	OPIS	PAKIRANJE (kg)	BOJA	ARTIKAL
<b>1676003</b>	SIKA MONOSEAL-101	20	SIVA	480132

## SikaTop® Seal 107 - DVOKOMPONENTNA HIDROIZOLACIJA



- » Visoka vodonepropusnost
- » Unaprijed izmjerene komponente: bez pogrešaka kod mješanja
- » Otpornost na savojna naprezanja, koja nisu predmet pucanja podloge
- » Paropropusan
- » Dobra prionjivost na gotovo sve podloge kao npr. beton, cementni mort, kamen, opeku, željezo...
- » Jednostavna primjena čak i na vertikalnim površinama i stropovima
- » Potrošnja: približno ~ 2.0 kg/m<sup>2</sup>/mm

VOKEL ŠIFRA	OPIS	PAKIRANJE (kg)	BOJA	ARTIKAL
<b>1676005</b>	SIKATOP®SEAL 107 KOMPONENTA B	20	SIVA	479498
<b>1676004</b>	SIKATOP®SEAL 107 KOMPONENTA A			

## Sikalastic® 1K - JEDNOKOMPONENTNA HIDROIZOLACIJA



- » Jednokomponentni proizvod, samo dodati vodu
- » Podesive konzistencije, lako se nanosi četkom ili gleterom
- » Nema klizanja i jednostavna primjena čak i na vertikalne površine
- » Dobra sposobnost premošćivanja pukotina
- » Vrlo dobra prionjivost na razne vrste podloga, uključujući beton, cementne mortove, kamen, opeku
- » Može se nanositi na vlažne podloge
- » Atest za pitku vodu

VOKEL ŠIFRA	OPIS	PAKIRANJE (kg)	BOJA	ARTIKAL
<b>1676002</b>	SIKALASTIC® 1K	20	SIVA	506520

## Sikalastic®-220 W - UNUTARNJA HIDROIZOLACIJA



- » Jedna komponenta spremna za upotrebu
- » Bez otapala
- » Vodonepropusno
- » Moguće koristiti za podno grijanje
- » Potrošnja ~ 1.35 kg/m<sup>2</sup>/mm u dva sloja
- » Za unutrašnju upotrebu

VOKEL ŠIFRA	OPIS	PAKIRANJE (kg)	BOJA	ARTIKAL
<b>1676001</b>	SIKALASTIC®-220 W	7	SIVA	532220

### Sika® SealTape S - TRAKA ZA IZOLACIJU



- » Visok elasticitet
- » Vodootporna
- » Kemijski otporna
- » Jednostavna za aplikaciju
- » Radna temperatura: -25 °C do +60 °C
- » Jednostavna primjena čak i na vertikalnim površinama i stropovima

VOKEL ŠIFRA	OPIS	PAKIRANJE (m)	BOJA	ARTIKAL
<b>1676007</b>	SIKA®SEALTAPE S	50	-	123265

### Sika® MonoTop-108 - BRZOVEZUJUĆI CEMENT



- » Koristi se za trenutno zaustavljanje prodora vode pod negativnom pritiskom (pukotine, rupe, spojevi)
- » Trenutno brtvljenje ispusta vode za vrijeme hidroizolacijskih radova
- » Brzo otvrdnjavanje (bez ispiranja) čak i pri tekućoj vodi
- » Otvrdnjava unutar 60-80 sekundi (pri +20°C)

VOKEL ŠIFRA	OPIS	PAKIRANJE (kg)	BOJA	ARTIKAL
<b>1676006</b>	MonoTop-108	5	SIVA	533495



## Sikaflex®-11 FC+ - MASA ZA BRTVLJENJE I LJEPLJENJE



- » Jednokomponentan, spreman za upotrebu
- » Fleksibilan i trajno elastičan
- » Bez otapala i mirisa
- » Vrlo niska emisija brtvilo: vezanje bez pojave mjehurića
- » Vrlo dobra prionjivost za većinu građevinskih materijala
- » Dobra mehanička otpornost
- » Dobra otpornost na atmosferske promjene i starenje
- » Ne curi / ne propada ljepilo: zaljepljene dijelove ne treba dodatno podlagati
- » Nije korozivan, ublažava udarce i vibracije
- » Dostupan u 5 boja
- » Brtvilo i višenamjensko ljepilo

VOKEL ŠIFRA	OPIS	PAKIRANJE (ml)	BOJA	ARTIKAL
<b>1676012</b>	SIKAFLEX-11	300	SMEĐA	83706
<b>1676013</b>	SIKAFLEX-11	300	CRNA	84387
<b>1676014</b>	SIKAFLEX-11	300	SIVA	83707
<b>1676015</b>	SIKAFLEX-11	300	BIJELA	83708
<b>1676016</b>	SIKAFLEX-11	300	BEŽ	84386

## Sika® Sanisil® - SANITARNI SILIKON



- » Dugoročna otpornost na gljivice i lišajeve
- » Odlična UV zaštita i otpornost na atmosferske promjene
- » Bez otapala
- » Visoka elastičnost i fleksibilnost
- » Dostupan u tri boje

VOKEL ŠIFRA	OPIS	PAKIRANJE (ml)	BOJA	ARTIKAL
<b>1676008</b>	SANISIL	300	BIJELA	73999
<b>1676009</b>	SANISIL	300	TRANSPARENTNA	73988
<b>1676010</b>	SANISIL	300	SIVA	72028

## Sikacryl®-108 S - AKRILNI SILIKON



- » Dobre mogućnosti nanošenja
- » Ne sadrži rastvarače
- » Bez mirisa
- » Na bazi vode
- » Može se farbati nakon očvršćivanja
- » Dobro prijanja na podloge kao što su drvo, beton itd.
- » Za vanjsku i unutarnju primjenu
- » Visoka postojanost, odlična UV otpornost
- » Otporan na kišu
- » Mogućnost kretanja 15%

VOKEL ŠIFRA	OPIS	PAKIRANJE (ml)	BOJA	ARTIKAL
<b>1676011</b>	SIKACRYL-108 S BIJELI	310	BIJELA	579705

## SikaBond® AT Universal - UNIVERZALNI SILIKON



- » Jednokomponentno, spremno za upotrebu
- » Visoka čvrstoća ljepljenja na različite podloge bez upotrebe primera
- » Odlična ugradivost
- » Kratka nit odvajanja od pakiranja prilikom ugradnje
- » Dobra početna čvrstoća i brzo otvrdnjavanje
- » Mogućnost kompeziranja neravnina na podlozi
- » Ne izaziva koroziju
- » Izvrsna otpornost na atmosferske promjene i vodu
- » Bez silikona
- » Može se prebojavati
- » Bez otapala
- » Dostupan u dvije boje: sivo i bijelo

VOKEL ŠIFRA	OPIS	PAKIRANJE (ml)	BOJA	ARTIKAL
<b>1676019</b>	SIKABOND-AT UNIVERSAL	300	SIVA	526922

## Sikaflex®-112 Crystal Clear - BEZBOJNO LJEPILO



- » Jednokomponentan, spreman za upotrebu, ljepilo i masa za brtvljenje
- » 100% transparentan
- » Dobro incijalno vezivanje
- » Veoma niska emisija isparavanja
- » Ljepilo-masa za brtvljenje sa CE certifikatom
- » Za unutarnju i vanjsku upotrebu

VOKEL ŠIFRA	OPIS	PAKIRANJE (ml)	BOJA	ARTIKAL
<b>1676018</b>	SIKAFLEX® -112 CRYSTAL CLEAR	290	PROZIRAN	581467

## Sika AnchorFix®-1 Crystal Clear - INEKCIONI MORT



- » Brzo vezanje
- » Korištenje standardnog pistolja
- » Aplikacija na niskim temperaturama
- » Velika nosivost
- » ETA odobrenje za sidrenje u betonu bez pukotina
- » ETA odobrenje za sidrenje u čvrstim i šupljim zidovima
- » Bez curenja
- » Slabog mirisa
- » Malo otpada

VOKEL ŠIFRA	OPIS	PAKIRANJE (ml)	BOJA	ARTIKAL
<b>1676017</b>	ANCHORFIX®-1	300	PROZIRAN	581467

GARANCIJA  
**2**  
GODINE



ARCEUS

**E.C.A.**®

TOGETHER FOR YEARS

342

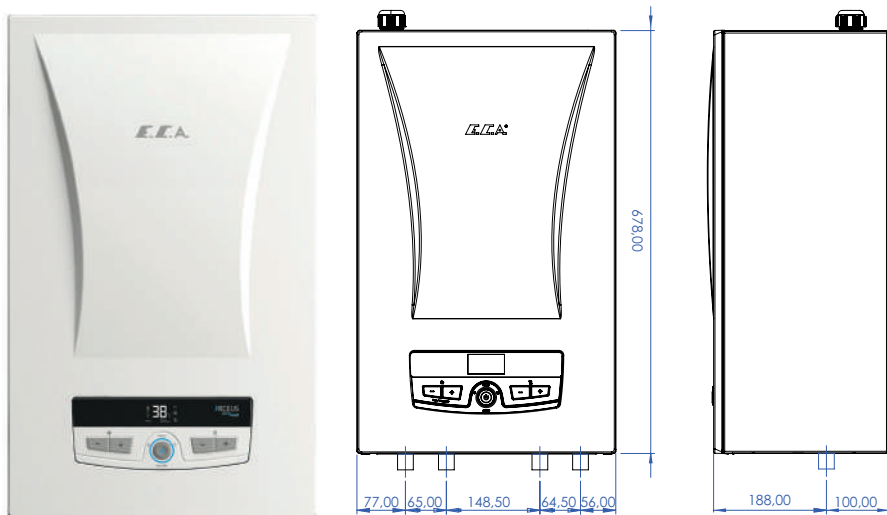

## OPIS PROIZVODA

E.C.A ARCEUS je linija termo blokova koja se sastoji od dva tipa. Tip CH koji se koristi za centralno grijanje, te tip MT koji podržava centralno grijanje i sanitarnu toplu vodu.

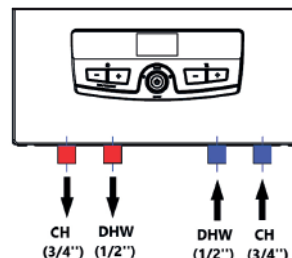

### MT TIP

Monotermički tip termo bloka funkcionira na način da zagrijava vodu za centralno grijanje, te istovremeno funkcionira kao protočni bojler za sanitarnu toplu vodu. Ovaj tip termo bloka u sebi ima dva kruga grijanja; jedan za grijanje prostora (CH), a drugi za sanitarnu toplu vodu (DHW). Može se koristiti za radijatorsko ili podno grijanje.

### CH TIP

Uređaji tipa CH (centralno grijanje) provode grijanje vode na istom principu kao MT uređaji. Razlika između njih je u tome što CH uređaji ne mogu osigurati grijanje sanitarne vode.

## Komponente termo bloka

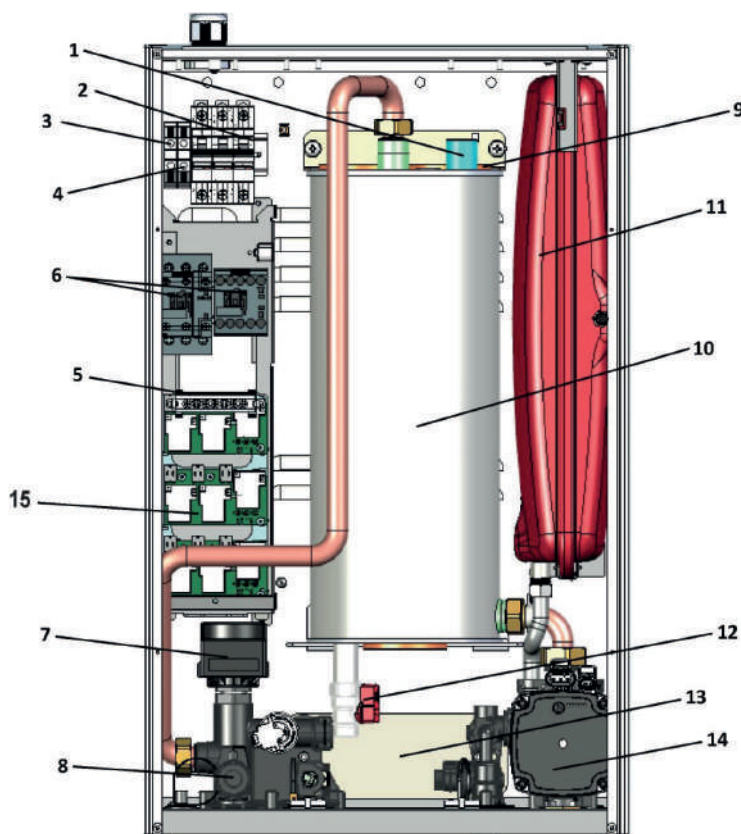

1. Ozraka
2. Osigurači
3. Stezaljka - uzemljenje
4. Stezaljka - neutralna
5. Neutralni sabirnik
6. Sklopnici
7. Troputni ventil
8. Sigurnosni ventil (3 bar)
9. Električni grijači
10. Glavni izmjenjivač topline
11. Ekspanzijska posuda
12. Ispusni ventil
13. Pločasti izmjenjivač (kod MT tipa)
14. Cirkulacijska pumpa (GRUNDFOSS UPM4 15-60)
15. Relejne ploče



## TABLICA TEHNIČKIH PODATAKA

(CH-centralno grijanje; DHW-sanitarna topla voda)

Tip uređaja	Mjerna jedinica	ARCEUS EK 6	ARCEUS EK 9	ARCEUS EK 12	ARCEUS EK 15	ARCEUS EK 18	ARCEUS EK 24	ARCEUS EK 27	
Nominalna snaga	kW	6	9	12	15	18	24	27	
Minimalna snaga grijanja	kW	2	3	2	2	2	2	3	
Broj grijača	6	kW	1	-	2	1	3	1	-
	9	kW	-	1	-	1	-	2	3
Raspon grijanja	°C	30-80							
DHW raspon temperature	°C	-	-	30-65					
DHW maksimalna temperatura	°C	-	-	65	65	65	65	65	
DHW maksimalni protok	l/min	-	-	7	8	9	10	10	
$\Delta T$ pri maksimalnom protoku	°C	-	-	24,6	26,9	28,7	34,4	38,7	
Napon napajanja	faza/V	1/230	1/230	1/230	3/400	3/400	3/400	3/400	
		3/400	3/400	3/400					
Nazivna struja	faza/A	1/26,1	1/39,1	1/52,2	3/21,7	3/26,1	3/34,8	3/39,1	
		3/8,7	3/13,1	3/17,4					
Presjek napojnog kabela	mm <sup>2</sup>	1/3x6	1/3x10	1/3x10	5x6	5x6	5x6	5x10	
		3/5x2,5	3/5x2,5	3/5x4					
Klasa zaštite	-	IPX4D	IPX4D	IPX4D	IPX4D	IPX4D	IPX4D	IPX4D	
Razina zvuka	dB	42	42	38	38	38	38	38	
Neto težina	kg	26	26	27	27	29	29	29	
Bruto težina	kg	29	29	30	30	32	32	32	
Dimenzije (VxŠxD)	mm	678x410x288							
Klasa energetske učinkovitosti	C H	-	D	D	D	D	D	D	
	D H W	-	-	C	C	C	C	C	

ŠIFRA VOKEL	NAZIV	ARTIKAL
<b>1478001</b>	Elektro kotao EK CH 6	8396255010
<b>1478002</b>	Elektro kotao EK CH 9	8396256010
<b>1478003</b>	Elektro kotao EK CH 12	8396257010
<b>1478004</b>	Elektro kotao EK CH 15	8396258010
<b>1478005</b>	Elektro kotao EK CH 18	8396259010
<b>1478006</b>	Elektro kotao EK CH 24	8396260010
<b>1478007</b>	Elektro kotao EK CH 27	8396261010
<b>1478008</b>	Elektro kotao EK MT 18	8396252010



### MAGIS

VIŠEĆA WC ŠKOLJKA



ŠIFRA VOKEL	OPIS	BOJA	ARTIKAL
<b>1727001</b>	WC ŠKOLJKA RIMLESSS	BIJELA	2731
<b>1727002</b>	HIGIJENSKA WC ŠKOLJKA RIMLESSS	BIJELA	2730

WC DASKA KOJU PREPORUČUJEMO

VOKEL ŠIFRA	OPIS	ARTIKAL
<b>0479030</b>	RAY SOFTCLOSE	531784

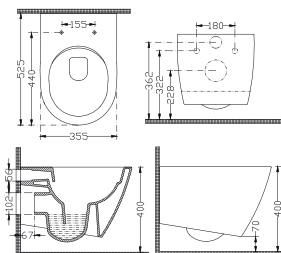

### MAGIS

HIGIJENSKA VIŠEĆA WC ŠKOLJKA



ŠIFRA VOKEL	OPIS	BOJA	ARTIKAL
<b>1727003</b>	RIMLESS S UGRAĐENIM VENTILOM	BIJELA	2733

WC DASKA KOJU PREPORUČUJEMO

VOKEL ŠIFRA	OPIS	ARTIKAL
<b>0479030</b>	RAY SOFTCLOSE	531784

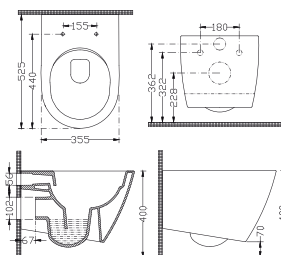

### MAGIS

VIŠEĆI BIDE



ŠIFRA VOKEL	OPIS	BOJA	ARTIKAL
<b>1727008</b>	VIŠEĆI BIDE MAGIS	BIJELA	2735

### VELA

VIŠEĆA WC ŠKOLJKA



ŠIFRA VOKEL	OPIS	BOJA	ARTIKAL
<b>1727004</b>	WC ŠKOLJKA RIMLESSS	BIJELA	2631
<b>1727005</b>	HIGIJENSKA WC ŠKOLJKA RIMLESSS	BIJELA	2630

WC DASKA KOJU PREPORUČUJEMO

VOKEL ŠIFRA	OPIS	ARTIKAL
<b>0479028</b>	RAY SOFTCLOSE	536117

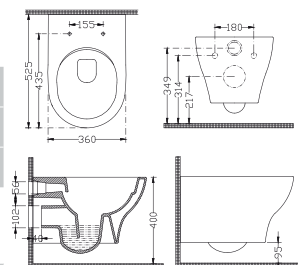



VELA  
VIŠEĆI BIDE

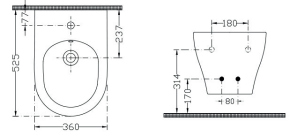

ŠIFRA VOKEL	OPIS	BOJA	ARTIKAL
<b>1727009</b>	VIŠEĆI BIDE VELA	BIJELA	2635

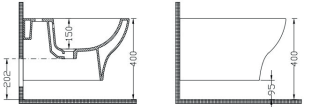

NORMA  
VIŠEĆA WC ŠKOLJKA



ŠIFRA VOKEL	OPIS	BOJA	ARTIKAL
<b>1727007</b>	WC ŠKOLJKA	BIJELA	1535 K
<b>1727006</b>	HIGIJENSKA WC ŠKOLJKA	BIJELA	1534 K

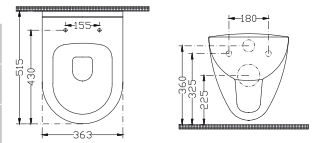

WC DASKA KOJU PREPORUČUJEMO

VOKEL ŠIFRA	OPIS	ARTIKAL
<b>0479027</b>	RAY SOFTCLOSE	531339

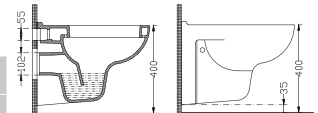



BATERIJA ZA UMIVAONIK

ESSENCE CRNA MAT

ŠIFRA VOKEL	BOJA	ŠIFRA ARTIKLA	PAKIRANJE
<b>0437366</b>	CRNA	24172KF1	1

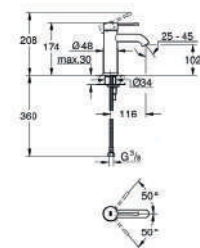

BATERIJA ZA UMIVAONIK

ESSENCE CRNA MAT

ŠIFRA VOKEL	BOJA	ŠIFRA ARTIKLA	PAKIRANJE
<b>0437370</b>	CRNA	24176KF1	1

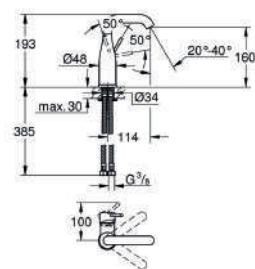

BATERIJA ZA UMIVAONIK

ESSENCE CRNA MAT - XL

ŠIFRA VOKEL	BOJA	ŠIFRA ARTIKLA	PAKIRANJE
<b>0437381</b>	CRNA	24177KF1	1

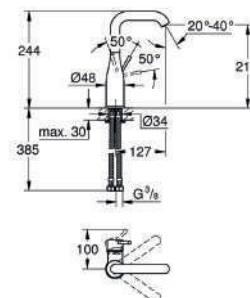

BATERIJA ZA UMIVAONIK

ESSENCE CRNA MAT - VISOKA

ŠIFRA VOKEL	BOJA	ŠIFRA ARTIKLA	PAKIRANJE
<b>0437371</b>	CRNA	24170KF1	1

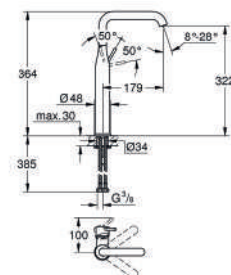

BATERIJA ZA UMIVAONIK

ESSENCE CRNA MAT - PODŽBUKNA

ŠIFRA VOKEL	BOJA	ŠIFRA ARTIKLA	PAKIRANJE
<b>0437372</b>	CRNA	29192KF1	1
NAPOMENA: UZ BATERIJU POTREBAN PODŽBUKNI MEHANIZAM			
<b>0437319</b>	/	23571000	1

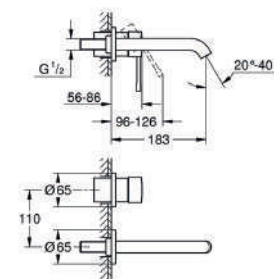



## BATERIJA ZA BIDE

ESSENCE CRNA MAT

ŠIFRA VOKEL	BOJA	ŠIFRA ARTIKLA	PAKIRANJE
<b>0437373</b>	CRNA	24395KF1	1

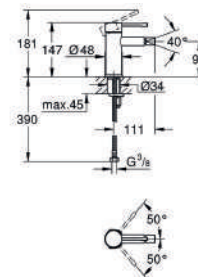

## BATERIJA ZA TUŠ

ESSENCE CRNA MAT

ŠIFRA VOKEL	BOJA	ŠIFRA ARTIKLA	PAKIRANJE
<b>0437374</b>	CRNA	25252KF1	1

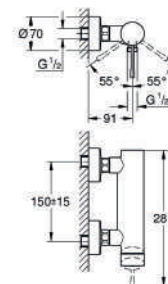

## BATERIJA ZA KADU

ESSENCE CRNA MAT

ŠIFRA VOKEL	BOJA	ŠIFRA ARTIKLA	PAKIRANJE
<b>0437375</b>	CRNA	25250KF1	1

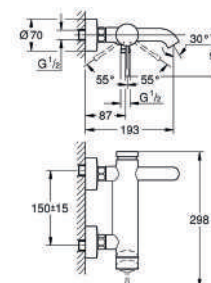

## BATERIJA ZA KADU

PODŽBUKNA ESSENCE CRNA MAT

ŠIFRA VOKEL	BOJA	ŠIFRA ARTIKLA	PAKIRANJE
<b>0437376</b>	CRNA	24167KF1	1

NAPOMENA: UZ BATERIJU POTREBAN PODŽBUKNI MEHANIZAM

<b>0437254</b>	/	35600000	1
----------------	---	----------	---

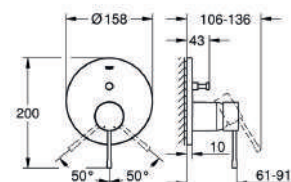

## BATERIJA ZA KADU - SMARTCONTROL

PODŽBUKNA TERMOSTATSKA BATERIJA S 2 VENTILA

ŠIFRA VOKEL	BOJA	ŠIFRA ARTIKLA	PAKIRANJE
<b>0437378</b>	CRNA	29507KF0	1

NAPOMENA: UZ BATERIJU POTREBAN PODŽBUKNI MEHANIZAM

<b>0437254</b>	/	35600000	1
----------------	---	----------	---

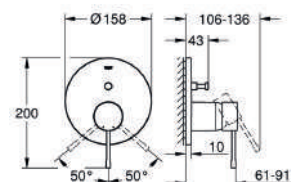

## RAINSHOWER COSMOPOLITAN

CRNI MAT - SA TUŠ GLAVOM FI 310

ŠIFRA VOKEL	BOJA	ŠIFRA ARTIKLA	PAKIRANJE
<b>0437377</b>	CRNA	22121KF0	1

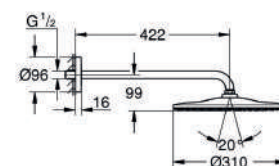



KOLJENO ZA TUŠ CRIJEVO

CRNO MAT

ŠIFRA VOKEL	BOJA	ŠIFRA ARTIKLA	PAKIRANJE
<b>0437384</b>	CRNA	22118KF0	1

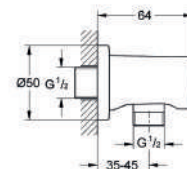

DRŽAČ TUŠ RUČICE

RAINSHOWER CRNI MAT

ŠIFRA VOKEL	BOJA	ŠIFRA ARTIKLA	PAKIRANJE
<b>0437383</b>	CRNA	22117KF0	1

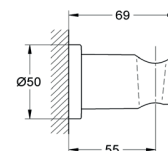

RAINSHOWER SMARTACTIVE 130

TUŠ RUČICA - CRNA MAT

ŠIFRA VOKEL	BOJA	ŠIFRA ARTIKLA	PAKIRANJE
<b>0437382</b>	SUNRISE	22127KF0	1

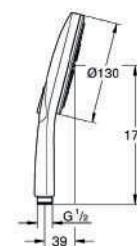

EUPHORIA

TUŠ RUČICA - CRNA

ŠIFRA VOKEL	BOJA	ŠIFRA ARTIKLA	PAKIRANJE
<b>0437386</b>	CRNA	22126KF0	1

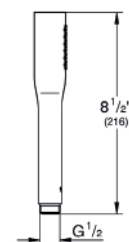

CRIJEVO ZA TUŠ

125 cm - CRNO MAT

ŠIFRA VOKEL	BOJA	ŠIFRA ARTIKLA	PAKIRANJE
<b>0437385</b>	CRNA	28362KF1	1



RAINSHOWER SMARTACTIV

900 mm - CRNO MAT

ŠIFRA VOKEL	BOJA	ŠIFRA ARTIKLA	PAKIRANJE
<b>0437380</b>	CRNA	22125KF0	1

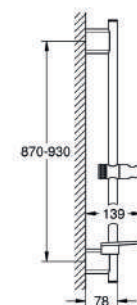





ESSENCE

CRNA MAT

ŠIFRA VOKEL	BOJA	ŠIFRA ARTIKLA	PAKIRANJE
<b>0437379</b>	CRNA MAT	30504KF0	1

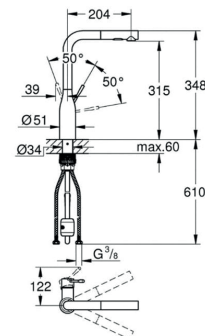

EUROSMART

VISOKI IZLJEV

ŠIFRA VOKEL	BOJA	ŠIFRA ARTIKLA	PAKIRANJE
<b>0437413</b>	CRNA	332022433	1

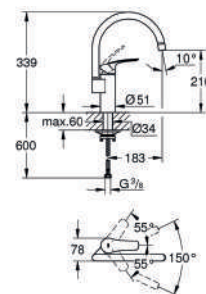



## BATERIJA ZA UMIVAONIK

EUROSMART CRNA MAT

ŠIFRA VOKEL	BOJA	ŠIFRA ARTIKLA	PAKIRANJE
<b>0437400</b>	CRNA	332652433	1

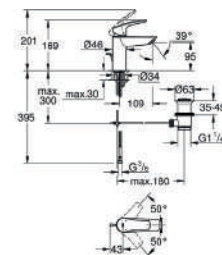

## BATERIJA ZA UMIVAONIK

EUROSMART CRNA MAT - XL

ŠIFRA VOKEL	BOJA	ŠIFRA ARTIKLA	PAKIRANJE
<b>0437402</b>	CRNA	233222433	1

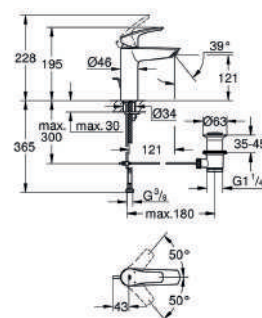

## BATERIJA ZA UMIVAONIK

ESUROSMART CRNA MAT - VISOKA

ŠIFRA VOKEL	BOJA	ŠIFRA ARTIKLA	PAKIRANJE
<b>0437401</b>	CRNA	239712433	1

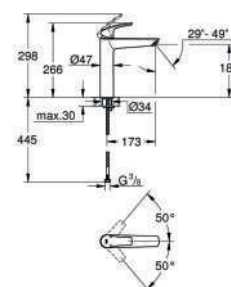

## BATERIJA ZA UMIVAONIK

EUROSMART CRNA MAT - PODŽBUKNA

ŠIFRA VOKEL	BOJA	ŠIFRA ARTIKLA	PAKIRANJE
<b>0437407</b>	CRNA	293382433	1
NAPOMENA: UZ BATERIJU POTREBAN PODŽBUKNI MEHANIZAM			
<b>0437319</b>	/	23571000	1

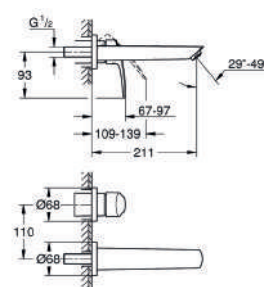

## BATERIJA ZA BIDE

EUROSMART CRNA MAT

ŠIFRA VOKEL	BOJA	ŠIFRA ARTIKLA	PAKIRANJE
<b>0437403</b>	CRNA	329292433	1

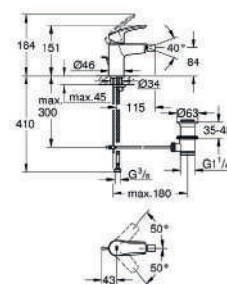



## BATERIJA ZA TUŠ

EUROSMART CRNA MAT

ŠIFRA VOKEL	BOJA	ŠIFRA ARTIKLA	PAKIRANJE
<b>0437399</b>	CRNA	335552433	1

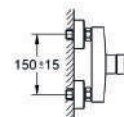
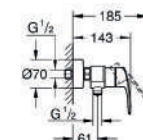

## BATERIJA ZA KADU

EUROSMART CRNA MAT

ŠIFRA VOKEL	BOJA	ŠIFRA ARTIKLA	PAKIRANJE
<b>0437398</b>	CRNA	333002433	1

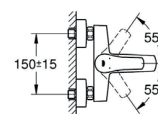
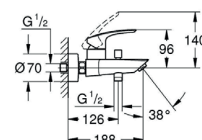

## BATERIJA ZA KADU

PODŽBUKNA EUROSMART CRNA MAT

ŠIFRA VOKEL	BOJA	ŠIFRA ARTIKLA	PAKIRANJE
<b>0437405</b>	CRNA	194502433	1

NAPOMENA: UZ BATERIJU POTREBAN PODŽBUKNI MEHANIZAM

<b>0437404</b>	/	33963000	1
----------------	---	----------	---

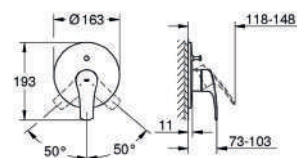

## BATERIJA ZA TUŠ

PODŽBUKNA EUROSMART CRNA MAT

ŠIFRA VOKEL	BOJA	ŠIFRA ARTIKLA	PAKIRANJE
<b>0437406</b>	CRNA	194512433	1

NAPOMENA: UZ BATERIJU POTREBAN PODŽBUKNI MEHANIZAM

<b>0437404</b>	/	33963000	1
----------------	---	----------	---

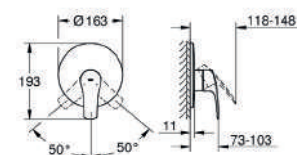

## PODŽBUKNI MEHANIZAM

ZA KADU I TUŠ

ŠIFRA VOKEL	BOJA	ŠIFRA ARTIKLA	PAKIRANJE
<b>0437404</b>	CRNA	33963000	1

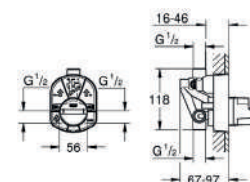

## TUŠ GLAVA TEMPESTA 250

CRNA MAT - S IZLJEVOM 380mm

ŠIFRA VOKEL	BOJA	ŠIFRA ARTIKLA	PAKIRANJE
<b>0437410</b>	CRNA	266682430	1

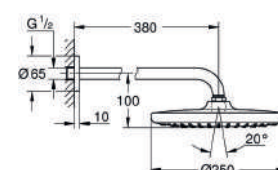



## TEMPESTA

TUŠ RUČICA - CRNA MAT

ŠIFRA VOKEL	BOJA	ŠIFRA ARTIKLA	PAKIRANJE
<b>0437408</b>	CRNA	261612433	1

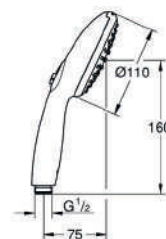

## TEMPESTA

TUŠ SET PODŽBUKNA INSTALACIJA - CRNA MAT

ŠIFRA VOKEL	BOJA	ŠIFRA ARTIKLA	PAKIRANJE
<b>0437409</b>	CRNA	264062433	1

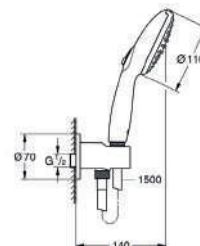

## TEMPESTA

TUŠ SET S ZIDNIM DRŽAČEM - CRNA MAT

ŠIFRA VOKEL	BOJA	ŠIFRA ARTIKLA	PAKIRANJE
<b>0437412</b>	CRNA	1025302431	1

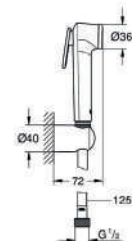

## TEMPESTA 110

TUŠ SET S KONZOLOM CRIJEVOM I TUŠ RUČICOM - CRNA MAT

ŠIFRA VOKEL	BOJA	ŠIFRA ARTIKLA	PAKIRANJE
<b>0437411</b>	CRNA	261622433	1

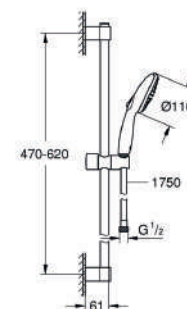

## TEMPESTA 250

TUŠ SUSTAV S TERMOSTATSKOM BATERIJOM - CRNA MAT

ŠIFRA VOKEL	BOJA	ŠIFRA ARTIKLA	PAKIRANJE
<b>0437396</b>	CRNA	266702431	1

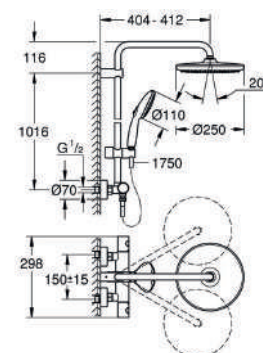



**POWER 5**

ALAT ZA REZANJE KERAMIKE

VOKEL ŠIFRA	DIMENZIJA (cm)	ARTIKAL
<b>1367107</b>	63x63	63P5
<b>1367108</b>	75x75	75P5
<b>1367109</b>	93x93	93P5
<b>1367110</b>	131x131	131P5
<b>1367111</b>	161x161	161P5



**EVOLUTION 3**

ALAT ZA REZANJE KERAMIKE

VOKEL ŠIFRA	DIMENZIJA FORMATA (cm)	ARTIKAL
<b>1367041</b>	52x52	52P3



**EVO2**

ALAT ZA REZANJE KERAMIKE

VOKEL ŠIFRA	DIMENZIJA DEBLJINE DO (mm)	ARTIKAL
<b>1367087</b>	35	905EVO2



**FL3**

SET ZA REZANJE VELIKIH FORMATA

VOKEL ŠIFRA	DIMENZIJA FORMATA (cm)	ARTIKAL
<b>1367103</b>	0-340	FL3



**F1**

ELEKTRIČNA REZALICA KERAMIKE

VOKEL ŠIFRA	DIMENZIJA (DxŠxV)	ARTIKAL
<b>1367045</b>	146x68x124	F1-101





BATTLE  
VIBRACIJSKI VAKUM PODIZAČ

VOKEL ŠIFRA	ARTIKAL
<b>1367083</b>	BATTLE



300-71SL2PZ  
VAKUM PODIZAČ KOMPLET 2 kom

VOKEL ŠIFRA	ARTIKAL
<b>1367093</b>	300-71SL2PZ



300-76  
VAKUM PODIZAČ ZA VELIKE FORMATE

VOKEL ŠIFRA	ARTIKAL
<b>1367076</b>	300-76



300-71  
VAKUM PODIZAČ ZA VELIKE FORMATE

VOKEL ŠIFRA	ARTIKAL
<b>1367061</b>	300-71



16-S  
RUČKA ZA PODIZANJE I PRIJENOS PLOČICA

VOKEL ŠIFRA	ARTIKAL
<b>1367095</b>	16-S



300-80L  
SET ZA DIZANJE VELIKIH FORMATA

VOKEL ŠIFRA	ARTIKAL
<b>1367097</b>	300-80L

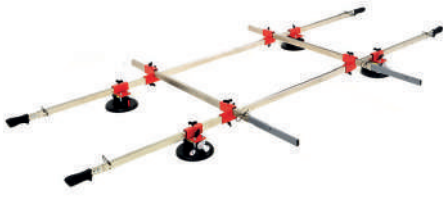

300-70SL

SET ZA DIZANJE VELIKIH FORMATA S TOČKIČIMA

VOKEL ŠIFRA	ARTIKAL
<b>1367098</b>	300-70SL

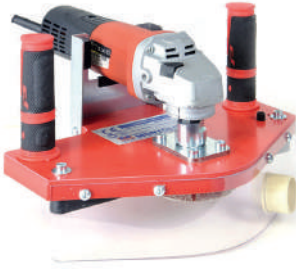

TOPROFILE

ELEKTRIČNI UREĐAJ ZA PROFILIRANJE

VOKEL ŠIFRA	ARTIKAL
<b>1367084</b>	TOPROFILE



TUTORCUT

VODILICA ZA PRECIZNO REZANJE

VOKEL ŠIFRA	ARTIKAL
<b>1367091</b>	TUTORCUT115-U



300-20

RADNI STOL ZA KERAMIČARE

VOKEL ŠIFRA	ARTIKAL
<b>1367080</b>	300-20



VERTIGO

STALAK ZA REZALICU

VOKEL ŠIFRA	ARTIKAL
<b>1367060</b>	VERTIGO2

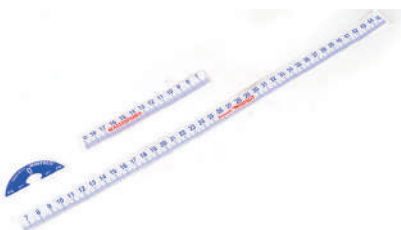

481P2

MJERNA TRAKA ZA REZALICU

VOKEL ŠIFRA	ARTIKAL
<b>1367077</b>	481P2



## X-WORKS

RADNI STOL ZA KERAMIČARE

VOKEL ŠIFRA	ARTIKAL
<b>1367046</b>	X-WORKS



## MOSAKIT

PODLOGA ZA REZANJE MOZAIKA

VOKEL ŠIFRA	ARTIKAL
<b>1367006</b>	58



## BASEBOARD

GRANIČNIK PRI REZANJU KERAMIKE

VOKEL ŠIFRA	ARTIKAL
<b>1367043</b>	64



## P5

NOSAČ REZNOG KOLA

VOKEL ŠIFRA	DIMENZIJA (mm)	ARTIKAL
<b>1367112</b>	7	505P5
<b>1367113</b>	12	506P5



## P5

NOSAČ REZNOG KOLA

VOKEL ŠIFRA	DIMENZIJA (mm)	ARTIKAL
<b>1367038</b>	7	505
<b>1367037</b>	12	506

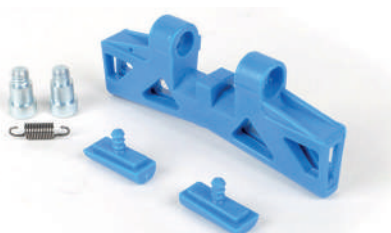

## 446P

STOPICA ZA REZANJE LKERAMIKE

VOKEL ŠIFRA	ARTIKAL
<b>1367036</b>	446P

**515-5**

AMPULE ZA PODMAZIVANJE

VOKEL ŠIFRA	PAKIRANJE (kom)	ARTIKAL
<b>1367039</b>	5	515-5

**T**

REZNO KOLO ZA REZANJE KERAMIKE



VOKEL ŠIFRA	ARTIKAL
<b>1367070</b>	240T
<b>1367063</b>	241T
<b>1367007</b>	243
<b>1367008</b>	243T

**55W2**

SPECIAL KLIJEŠTA ZA KERAMIKU

VOKEL ŠIFRA	ARTIKAL
<b>1367010</b>	55W2

**33W**

KLIJEŠTA ZA KERAMIKU

VOKEL ŠIFRA	ARTIKAL
<b>1367088</b>	33W

**56R**

KLIJEŠTA ZA LOMLJENJE KERAMIKE Max 20 mm

VOKEL ŠIFRA	ARTIKAL
<b>1367082</b>	56R

**449P**

PRODUŽENA NOGICA ZA LOM KERAMIKE

VOKEL ŠIFRA	ARTIKAL
<b>1367071</b>	449P



## MFL2

ELEKTERIČNA REZALICA KERAMIKE

VOKEL ŠIFRA	ARTIKAL
<b>1367081</b>	MFL2-PU



## CZ

REZNA PLATA

VOKEL ŠIFRA	DIMENZIJA (Ø mm)	ARTIKAL
<b>1367011</b>	100	CZ115



## CSE

REZNA PLATA

VOKEL ŠIFRA	DIMENZIJA (Ø mm)	ARTIKAL
<b>1367012</b>	115	CSE115



## CG

REZNA PLATA

VOKEL ŠIFRA	DIMENZIJA (Ø mm)	ARTIKAL
<b>1367014</b>	115	CG115



## CPF

REZNA PLATA

VOKEL ŠIFRA	DIMENZIJA (Ø mm)	ARTIKAL
<b>1367065</b>	200	CPF200

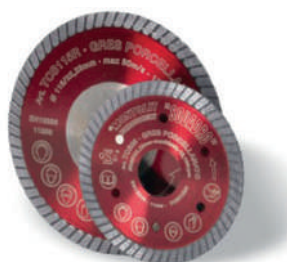

## TCS

REZNA PLATA

VOKEL ŠIFRA	DIMENZIJA (Ø mm)	ARTIKAL
<b>1367015</b>	85	TCS85





SCX

REZNA PLATA

VOKEL ŠIFRA	DIMENZIJA (Ø mm)	ARTIKAL
<b>1367027</b>	250	SCX250
<b>1367017</b>	350	SCX350



CX

REZNA PLATA

VOKEL ŠIFRA	DIMENZIJA (Ø mm)	ARTIKAL
<b>1367047</b>	250	CX250



CBX

REZNA PLATA

VOKEL ŠIFRA	DIMENZIJA (Ø mm)	ARTIKAL
<b>1367049</b>	115	CBX115



TXH

REZNA PLATA

VOKEL ŠIFRA	DIMENZIJA (Ø mm)	ARTIKAL
<b>1367050</b>	115	TXH115



CM MOSAIC

REZNA PLATA ZA MOZAIK

VOKEL ŠIFRA	DIMENZIJA (Ø mm)	ARTIKAL
<b>1367051</b>	115	CM115



CGX

REZNA PLATA TURMONT

VOKEL ŠIFRA	DIMENZIJA (Ø mm)	ARTIKAL
<b>1367078</b>	115	CGX115



## TCS-R

REZNA PLATA TURMONT

VOKEL ŠIFRA	DIMENZIJA (Ø mm)	ARTIKAL
<b>1367052</b>	115	TCS115R



## STL-GF-M

PLATA ZA REZANJE I POLIRANJE - SITNA ZRNCA

VOKEL ŠIFRA	DIMENZIJA (Ø mm)	ARTIKAL
<b>1367073</b>	115	STL115GF-M
<b>1367057</b>	125	STL125GF-M



## STIL-GG

DISK ZA POLIRANJE I REZANJE - KRUPNA ZRNCA

VOKEL ŠIFRA	DIMENZIJA (Ø mm)	ARTIKAL
<b>1367074</b>	115	STL115GG



## PEBS-GF

DISK ZA BRUŠENJE

VOKEL ŠIFRA	DIMENZIJA (Ø mm)	ARTIKAL
<b>1367072</b>	115	PEBS115GF



## FAJ

SVRDLO S DIJAMANTOM ZA BUŠENJE

VOKEL ŠIFRA	DIMENZIJA (Ø mm)	ARTIKAL
<b>1367018</b>	6	FAJ06
<b>1367019</b>	8	FAJ08
<b>1367020</b>	10	FAJ10
<b>1367021</b>	12	FAJ12



## FAJVA-N

SET DIJAMANTNA SVRDLA

VOKEL ŠIFRA	ARTIKAL
<b>1367089</b>	FAJVA-N



**FAJVA-N**  
SET ZA BUŠENJE

VOKEL ŠIFRA	DIMENZIJA (Ø mm)	ARTIKAL
<b>1367022</b>	5/6/7/8/10/12	FAJVA-N
<b>1367053</b>	5/6/7/8/10/12 (za suho bušenje)	FAJVA-N



**FSB KIT**  
SET ZA BUŠENJE

VOKEL ŠIFRA	DIMENZIJA (Ø mm)	ARTIKAL
<b>1367032</b>	6/8/10	FSBKIT



**FT**  
SET ZA BUŠENJE

VOKEL ŠIFRA	DIMENZIJA (Ø mm)	ARTIKAL
<b>1367067</b>	20	FT20
<b>1367023</b>	35	FT35
<b>1367031</b>	40	FT40
<b>1367024</b>	60	FT60



**FS**  
SET ZA BUŠENJE

VOKEL ŠIFRA	DIMENZIJA (Ø mm)	ARTIKAL
<b>1367090</b>	10	FS10
<b>1367025</b>	35	FS35
<b>1367028</b>	60	FS60
<b>1367069</b>	68	FS68

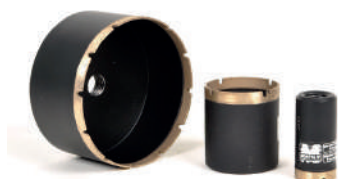

**FA**  
DIJAMANTNA KRUNA ZA BUŠENJE

VOKEL ŠIFRA	DIMENZIJA (Ø mm)	ARTIKAL
<b>1367104</b>	40	FA40
<b>1367105</b>	65	FA65



## FT-S

DIJAMANTNA KRUNA ZA BUŠENJE

VOKEL ŠIFRA	DIMENZIJA (Ø mm)	ARTIKAL
<b>1367054</b>	35	FT-S35
<b>1367092</b>	40	FT-S40



## FPU

DIJAMANTNA KRUNA ZA BUŠENJE

VOKEL ŠIFRA	DIMENZIJA (Ø mm)	ARTIKAL
<b>1367056</b>	20	FPU20



## FPS

SVRDLO ZA PROŠIRIVANJE RUPA

VOKEL ŠIFRA	DIMENZIJA (Ø mm)	ARTIKAL
<b>1367079</b>	35-75	FPS75



## FPB

ALAT ZA SKIDANJE RUBOVA

VOKEL ŠIFRA	DIMENZIJA (mm)	ARTIKAL
<b>1367033</b>	10	FPB10



## FPB

DIJAMANTNI PROFILER

VOKEL ŠIFRA	ARTIKAL
<b>1367099</b>	FPB03TP
<b>1367100</b>	FPB05TP
<b>1367101</b>	FPB10TP



## FPE

DIJAMANTNI PROFILER

VOKEL ŠIFRA	ARTIKAL
<b>1367085</b>	FPE15TPGF



FPE  
DIJAMANTNI PROFILER

VOKEL ŠIFRA	ARTIKAL
<b>1367102</b>	FPE15TP



AUFA  
SPOJNICA ZA DIJAMANTNE KRUNE

VOKEL ŠIFRA	ARTIKAL
<b>1367106</b>	AUFA



300-VAS  
DIJAMANTNI SET ZA TANKE PLOČICE

VOKEL ŠIFRA	ARTIKAL
<b>1367086</b>	300-VAS



M-PERFORMER  
RASHLADNA TEKUĆINA ZA DIJAMANTNO SVRDLO

VOKEL ŠIFRA	DIMENZIJA (Ø mm)	ARTIKAL
<b>1367068</b>	12	M-PERFORMER

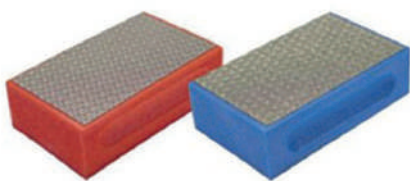

DT  
DIJAMANTNE SPUŽVICE

VOKEL ŠIFRA	ARTIKAL
<b>1367034</b>	DT262



PDR  
NOSAČ DIJAMANTNIH JASTUČIĆA ZA POLIRANJE

VOKEL ŠIFRA	ARTIKAL
<b>1367058</b>	PDR





PDR

DIJAMANTNI JASTUČIĆ POZICIJA "0"

VOKEL ŠIFRA	ARTIKAL
<b>1367075</b>	PDR0

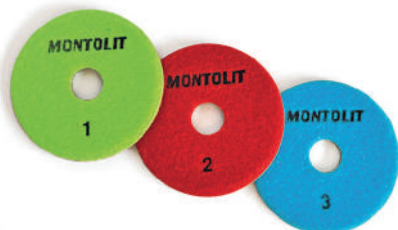

PDR KIT

SET DIJAMANTNIH JASTUČIĆA

VOKEL ŠIFRA	ARTIKAL
<b>1367059</b>	PDRKIT



### MAGNETNI ODVAJAČ NEČISTOĆA

- Multifunkcionalni uređaj s hvatačem nečistoća i filterom
- Jedinstven jer u potpunosti čisti hidraulički krug s ciljem trajne zaštite generatora i ostalih komponenata
- Tijelo od tehнопolimera
- Hvatač nečistoća s unutarnjim elementom od tehнопolimera s magnetom
- Zaporni ventil s maticom, tijelo od mesinga
- Pogodno za okomite, vodoravne ili cijevi pod 45°C
- Ispusna slavina s priključkom za crijevom
- Pmax radni: 3bar
- Tmin-Tmax: 0-90°C
- Mehanička ozračna slavina
- Maksimalni protok 1"KVS (m<sup>3</sup>/h) 14,50

VOKEL ŠIFRA	OPIS	ARTIKAL
<b>1781001</b>	MAGNETNI ODVAJAČ NEČISTOĆA 1" S VENTILIMA	AFM-08B
<b>1781002</b>	MAGNETNI ODVAJAČ NEČISTOĆA 5/4" S VENTILIMA	AFM-08B
<b>1781003</b>	ZAMJENSKI FILTER ZA MAGNETNI ODVAJAČ NEČISTOĆA	RPF-SS

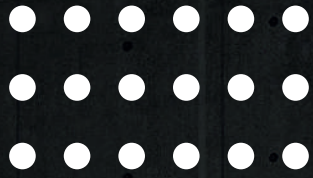

# Aria<sup>A</sup>

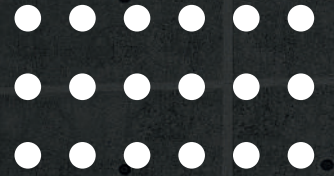

### RUBIN WHITE

VISEĆA WC ŠKOLJKA BEZ DASKE



ŠIFRA VOKEL	DIMENZIJA (cm)	BOJA	ART.
<b>1732001</b>	53,5	WHITE	MGZ(Y)-3105B
<b>1732002</b>	53,5	WHITE MATT	MGZ(Y)-3105B-MW
<b>1732004</b>	48,2	WHITE	MGZ(Y)-3105
<b>1732005</b>	48,2	WHITE MATT	MGZ(Y)-3105MW

### RUBIN WHITE

WC DASKA



ŠIFRA VOKEL	OPIS	BOJA	ART.
<b>1732011</b>	ZA ŠKOLJKE 1732001 i 1732004	WHITE	MO660
<b>1732012</b>	ZA ŠKOLJKE 1732002 i 1732005	WHITE MATT	MO660-MW

### RUBIN BLACK

VISEĆA WC ŠKOLJKA BEZ DASKE



ŠIFRA VOKEL	DIMENZIJA (cm)	BOJA	ART.
<b>1732003</b>	53,5	BLACK MATT	MGZ(Y)-3105B-MB
<b>1732006</b>	48,2	BLACK MATT	MGZ(Y)-3105MB

### RUBIN BLACK

WC DASKA



ŠIFRA VOKEL	OPIS	BOJA	ART.
<b>1732013</b>	ZA ŠKOLJKE 1732003 i 1732006	BLACK MATT	MO660-MB

### OPAL

VISEĆA WC ŠKOLJKA BEZ DASKE



ŠIFRA VOKEL	BOJA	ART.
<b>1732007</b>	WHITE	MGZ - 20



VENETO

PODNA WC ŠKOLJKA - ODVOD U ZID, BEZ DASKE

ŠIFRA VOKEL	BOJA	ART.
<b>1732008</b>	WHITE	MKZ-45D



VENETO

WC DASKA

ŠIFRA VOKEL	OPIS	BOJA	ART.
<b>1732014</b>	ZA ŠKOLJKU 1732008	WHITE	MU6157



REZERVNI VIJCI

ZA VISEĆU WC ŠKOLJKU

ŠIFRA VOKEL	OPIS	ART.
<b>1732015</b>	ZA VISEĆU WC ŠKOLJKU RUBIN (1732004, 1732005, 1732006)	WS-001



REZERVNI VIJCI

ZA VISEĆU WC ŠKOLJKU

ŠIFRA VOKEL	OPIS	ART.
<b>1732021</b>	ZA WC VISEĆU WC ŠKOLJKU RUBIN (1732001, 1732002, 1732003)	WS-002



REZERVNI VIJCI

ZA WC DASKU

ŠIFRA VOKEL	OPIS
<b>1732016</b>	ZA WC DASKU 1732011



REZERVNI VIJCI

ZA WC DASKU

ŠIFRA VOKEL	OPIS
<b>1732017</b>	ZA WC DASKU 1732012





REZERVNI VIJCI  
ZA WC DASKU

ŠIFRA VOKEL	OPIS
<b>1732018</b>	ZA WC DASKU 1732013



REZERVNI VIJCI  
ZA WC ŠKOLJKU

ŠIFRA VOKEL	OPIS	ART.
<b>1732019</b>	ZA WC ŠKOLJKU VENETO 1732008	FS-001

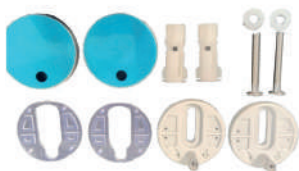

REZERVNI VIJCI  
ZA WC DASKU

ŠIFRA VOKEL	OPIS	ART.
<b>1732020</b>	ZA WC DASKU 1732014	HG-MU6157

## UMIVAONICI



TOPAZ

ŠIFRA VOKEL	OPIS	DIMENZIJA (cm)	BOJA	ART.
<b>1732009</b>	UMIVAONIK TOPAZ WHITE	53x46	WHITE	MHP-45



MOLISE

ŠIFRA VOKEL	OPIS	DIMENZIJA (cm)	BOJA	ART.
<b>1732010</b>	UMIVAONIK MOLISE WHITE	54,5x45,5	WHITE	MHP-14



## VISOKOTEMPERATURNA DIZALICA TOPLINE

75°C

Zrak - Voda

- ▶ **R290 Rashladni plin**
- ▶ **Energetska klasa: A+++**
- ▶ **Grijanje + Hlađenje + Topla voda**
- ▶ **DC inverterski kompresor i motor ventilatora**
- ▶ **Maksimalna izlazna temperatura: 75°C**
- ▶ **WiFi upravljanje**
- ▶ **Inverterska cirkulacijska pumpa**
- ▶ **Modbus RS485**

DIZALICA TOPLINE je uređaj s vrlo visokim stupnjem iskorištenja, koji energiju crpi iz okoliša. Energiju koju crpi ovaj uređaj priroda daje potpuno besplatno. Osim grijanja i pripreme sanitarne tople vode ovi uređaji mogu služiti i za hlađenje, što je velika prednost u odnosu na tradicionalne sustave koji služe samo za grijanje. Za rad ovih uređaja nije potrebna izgradnja dimnjaka, a za instalaciju je potreban samo 1 m<sup>2</sup>.



**Visokotemperaturna dizalica topline za grijanje + hlađenje + PTV (Monoblok R290)**
**Značajke:**

1. R290 rashladni plin
2. Energetska klasa: A+++
3. Grijanje+Hlađenje+PTV
4. DC inverter kompresor i motor ventilatora
5. Maksimalna temperatura vode: 75°C
6. WiFi pametno upravljanje
7. Inverterska cirkulacijska pumpa (ugrađena)
8. Modbus RS485 (internet dijagnostika)



MODEL		BLN-006TC1	BLN-008TC1	BLN-012TC1	BLN-012TC3	BLN-018TC1	BLN-018TC3	
Napajanje	V/Ph/Hz	220~240/1/50	220~240/1/50	220~240/1/50	380~415/3/50	220~240/1/50	380~415/3/50	
Presjek kabela	mm <sup>2</sup>	4	4	4	4	6	4	
Nominalno grijanje (Max) (A7/6°C, W30/35°C)	Kapacitet grijanja	kW	2.92~9.10	4.10~12.10	4.30~15.20	4.30~15.20	7.24~21.90	7.24~21.90
	Ulazna snaga	kW	0.61~2.11	0.79~2.85	0.87~3.73	0.87~3.73	1.05~5.73	1.50~5.73
	Ulazna struja	A	2.80~9.25	3.45~13.04	4.02~16.38	1.78~6.04	6.86~30.25	2.82~9.16
	COP	W/W	4.31~5.66	4.24~5.57	4.08~5.75	4.08~5.57	3.82~5.59	3.82~5.59
Nominalno grijanje (Max) (A7/6°C, W47/55°C)	Kapacitet grijanja	kW	2.99~8.16	4.05~11.95	4.25~14.55	4.25~14.55	6.36~19.45	6.36~19.45
	Ulazna snaga	kW	1.03~2.92	1.38~4.01	1.45~4.78	1.45~4.78	2.15~6.75	2.15~6.75
	Ulazna struja	A	4.57~12.79	5.73~17.70	6.71~18.80	2.84~6.78	9.84~30.12	3.71~10.60
	COP	W/W	2.79~3.46	2.98~3.45	3.04~3.45	3.04~3.45	2.88~3.75	2.88~3.75
Nominalno hlađenje (Max) (A35/24°C, W12/7°C)	Kapacitet hlađenja	kW	1.38~5.70	3.65~8.59	3.65~11.04	3.65~11.04	4.55~17.20	4.55~17.20
	Ulazna snaga	kW	0.67~2.44	1.12~3.31	1.12~3.37	1.12~4.37	1.85~7.31	1.85~7.31
	Ulazna struja	A	3.06~10.27	5.18~14.47	5.18~17.44	1.97~6.30	8.47~32.1	2.99~11.26
ERP razina (Temperatura polaza vode 35°C)	/	A+++	A+++	A+++	A+++	A+++	A+++	
Nazivna ulazna snaga	kW	3,50	5,40	5,40	5,85	7,50	10,50	
Nazivna ulazna struja	A	15,0	25,0	25,0	10,0	35,0	17,0	
Tip rashladnog sredstva / Punjenje	/kg	R290/0.55	R290/1.05	R290/1.05	R290/1.05	R290/1.40	R290/1.40	
CO <sub>2</sub> Ekvivalent	/	0.0017t	0.0032t	0.0032t	0.0032t	0.0042t	0.0042t	
Radni tlak (Niski)	MPa	0,8	0,8	0,8	0,8	0,8	0,8	
Radni tlak (Visoki)	MPa	3,0	3,0	3,0	3,0	3,0	3,0	
Maksimalni dozvoljeni tlak	MPa	3,2	3,2	3,2	3,2	3,2	3,2	
Nazivni protok vode	m <sup>3</sup> /h	1,00	1,40	2,06	2,06	3,10	3,10	
Broj ventilatora	/	1	1	1	1	2	2	
Tip motora ventilatora	/	DC inverter						
Tip kompresora	/	DC inverter						
Cirkulacijska pumpa	/	Inverterski tip / Ugrađena						
IP klasa	/	IPX4						
Razina buke (1 m udaljenost)	dB(A)	46	43	53	54	56	56	
Maksimalna temperatura vode na prolazu	°C	75	75	75	75	75	75	
Hidraulički priključak	inch	G1	G1	G1	G1	G1-1/4	G1-1/4	
Pad tlaka vode (Max)	kPa	20	20	20	20	55	55	
Radni raspon (Grijanje)	°C	-25~45						
Radni raspon (Hlađenje)	°C	16~45						
Dimenzije uređaja (DxŠxV)	mm	1187x418x808	1287x438x908	1287x438x908	1287x438x908	1187x488x1460	1187x488x1460	
Dimenzije uređaja u kutiji (DxŠxV)	mm	1217x463x920	1317x493x1020	1317x493x1020	1317x493x1020	1217x538x1570	1217x538x1570	
Težina uređaja	kg	110	134	134	134	195	195	
Težina uređaja s kutijom	kg	125	153	153	153	210	210	

VOKEL ŠIFRA	OPIS	SNAGA (kW)	ARTIKAL
<b>1482001</b>	VISOKOTEMPERATURNA DIZALICA TOPLINE - MONOFAZNA	6	31070002000158
<b>1482006</b>	VISOKOTEMPERATURNA DIZALICA TOPLINE - MONOFAZNA	8	31070002000185
<b>1482002</b>	VISOKOTEMPERATURNA DIZALICA TOPLINE - MONOFAZNA	12	31070002000159
<b>1482003</b>	VISOKOTEMPERATURNA DIZALICA TOPLINE - TROFAZNA	12	31070002000160
<b>1482004</b>	VISOKOTEMPERATURNA DIZALICA TOPLINE - MONOFAZNA	18	31070002000161
<b>1482005</b>	VISOKOTEMPERATURNA DIZALICA TOPLINE - TROFAZNA	18	31070002000162



# HEATSENSE

## Katalog proizvoda





## ELEKTRIČNA GRIJAĆA MREŽA

- » **Konstrukcija kabela:** Dvožilni vodič
- » **Jamstvo:** 20 godina
- » **Izolacija vodiča:** FEP
- » **Metalni omotač:** 100% aluminijska folija
- » **Vanjski omotač:** PVDF
- » **Debljina kabela:** 3 mm
- » **Razmak kabela:** 80 mm
- » **Snaga:** 150W/m<sup>2</sup>
- » **Napon:** 230 V
- » **Zaštita:** IPX7
- » **Samoljepljiva**

VOKEL ŠIFRA	OPIS	SNAGA (W)	DIMENZIJE DxŠ	OTPOR Ω	ARTIKAL
<b>1487001</b>	ELEKTRIČNA GRIJAĆA MREŽA 1.0 m <sup>2</sup>	150 W	2x0,5 m	352.7	HS-MAT 1.0m <sup>2</sup>
<b>1487002</b>	ELEKTRIČNA GRIJAĆA MREŽA 1.5 m <sup>2</sup>	225 W	3x0,5 m	235.1	HS-MAT 1.5m <sup>2</sup>
<b>1487003</b>	ELEKTRIČNA GRIJAĆA MREŽA 2.0 m <sup>2</sup>	300 W	4x0,5 m	176.3	HS-MAT 2.0m <sup>2</sup>
<b>1487004</b>	ELEKTRIČNA GRIJAĆA MREŽA 2.5 m <sup>2</sup>	375 W	5x0,5 m	141.1	HS-MAT 2.5m <sup>2</sup>
<b>1487005</b>	ELEKTRIČNA GRIJAĆA MREŽA 3.0 m <sup>2</sup>	450 W	6x0,5 m	117.6	HS-MAT 3.0m <sup>2</sup>
<b>1487006</b>	ELEKTRIČNA GRIJAĆA MREŽA 3.5 m <sup>2</sup>	525 W	7x0,5 m	100.8	HS-MAT 3.5m <sup>2</sup>
<b>1487007</b>	ELEKTRIČNA GRIJAĆA MREŽA 4.0 m <sup>2</sup>	600 W	8x0,5 m	88.2	HS-MAT 4.0m <sup>2</sup>
<b>1487008</b>	ELEKTRIČNA GRIJAĆA MREŽA 5.0 m <sup>2</sup>	750 W	10x0,5 m	70.5	HS-MAT 5.0m <sup>2</sup>
<b>1487009</b>	ELEKTRIČNA GRIJAĆA MREŽA 6.0 m <sup>2</sup>	900 W	12,0,5 m	58.8	HS-MAT 6.0m <sup>2</sup>
<b>1487010</b>	ELEKTRIČNA GRIJAĆA MREŽA 7.0 m <sup>2</sup>	1050 W	14x0,5 m	50.4	HS-MAT 7.0m <sup>2</sup>
<b>1487011</b>	ELEKTRIČNA GRIJAĆA MREŽA 8.0 m <sup>2</sup>	1200 W	16x0,5 m	44.1	HS-MAT 8.0m <sup>2</sup>
<b>1487012</b>	ELEKTRIČNA GRIJAĆA MREŽA 9.0 m <sup>2</sup>	1350 W	18x0,5 m	39.2	HS-MAT 9.0m <sup>2</sup>
<b>1487013</b>	ELEKTRIČNA GRIJAĆA MREŽA 10.0 m <sup>2</sup>	1500 W	20x0,5 m	35.3	HS-MAT 10.0m <sup>2</sup>
<b>1487014</b>	ELEKTRIČNA GRIJAĆA MREŽA 12.0 m <sup>2</sup>	1800 W	24x0,5 m	29.4	HS-MAT 12.0m <sup>2</sup>



ANALOGNI TERMOSTAT



- » **Jamstvo:** 2 godine
- » **Napon:** 230 V
- » **Raspon temperature:** 5°C - 40°C
- » **LED indikator:** On/Off
- » **Zaštita:** IP20
- » **Nazivna struja:** 16A
- » **Podni senzor:** NTC senzor

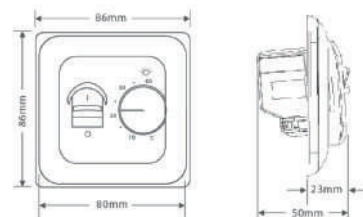

VOKEL ŠIFRA	BOJA	ARTIKAL
<b>1488001</b>	BIJELA	HS-50W

DIGITALNI INTERNET TERMOSTAT



- » **Jamstvo:** 2 godine
- » **Napon:** 230 V
- » **Zaštita:** IP20
- » **Nazivna struja:** 16A
- » **Podni senzor:** NTC senzor

1. Termostat s tjednim programom
2. WIFI konekcija
3. Ultra veliki LCD ekran
4. Može se individualno prilagoditi osobnim potrebama - može se postaviti do 6 intervala grijanja zasebno
5. Preporučuje se za upravljanje el. podnim mrežama

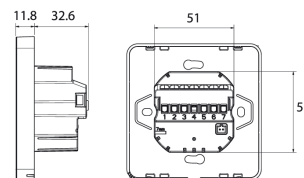

VOKEL ŠIFRA	BOJA	ARTIKAL
<b>1488002</b>	BIJELA	HS-100WIFIW
<b>1488003</b>	CRNA	HS-101WIFIB

DIGITALNI TERMOSTAT



- » **Jamstvo:** 2 godine
- » **Napon:** 230 V
- » **Zaštita:** IP20
- » **Nazivna struja:** 16A
- » **Podni senzor:** NTC senzor

1. Termostat s tjednim programom
2. Ultra veliki LCD ekran
3. Može se individualno prilagoditi osobnim potrebama - može se postaviti do 6 intervala grijanja zasebno
4. Preporučuje se za upravljanje el. podnim mrežama

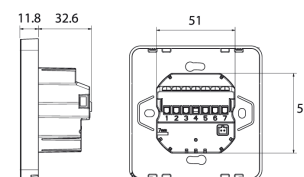

VOKEL ŠIFRA	BOJA	ARTIKAL
<b>1488004</b>	BIJELA	HS-110W
<b>1488005</b>	CRNA	HS-111B

### MOTORNI POGON



- » NC - Normalno zatvaranje
- » Napon: 230V

VOKEL ŠIFRA	OPIS	ARTIKAL
<b>1488006</b>	MOTORNI POGON M30X1,5	HS-230NC

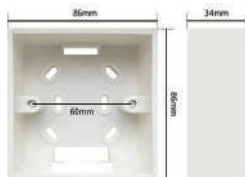

### NADŽBUKNA KUTIJA

- » Dimenzija: 86x86x34 mm



VOKEL ŠIFRA	OPIS	ARTIKAL
<b>1488007</b>	NADŽBUKNA KUTIJA ZA TERMOSTAT	HS-8601

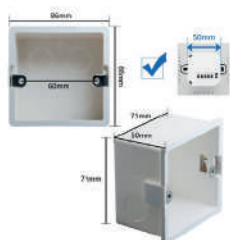

### PODŽBUKNA KUTIJA

- » Dimenzija: 86x86x50 mm



VOKEL ŠIFRA	OPIS	ARTIKAL
<b>1488008</b>	PODŽBUKNA KUTIJA ZA TERMOSTAT	HS-8602

### SENZOR

- » Dužina: 3 m



VOKEL ŠIFRA	OPIS	ARTIKAL
<b>1488009</b>	PODNI SENZOR	HS-3950

### SENZOR

- » Dužina: 3 m



VOKEL ŠIFRA	OPIS	ARTIKAL
<b>1488010</b>	PODNI SENZOR	HS-3380



SUPAL POSTOLJE

FIKSNI I SAMONIVELIRAJUĆI SA NAGBIOM DO 5%

VOKEL ŠIFRA	OPIS
<b>1694001</b>	NISKO POSTOLJE ZA PODIGNUTE PODOVE 28-43 mm



SUPAS POSTOLJE

FIKSNI I SAMONIVELIRAJUĆI SA NAGBIOM DO 5%

VOKEL ŠIFRA	OPIS
<b>1694002</b>	POSTOLJE ZA PODIGNUTE PODOVE 43-58 mm



SUPT4 POSTOLJE

KOMBINIRATI SA SUPB-MAX 3 SUPB

VOKEL ŠIFRA	OPIS
<b>1694007</b>	NISKO POSTOLJE ZA PODIGNUTE PODOVE 10-15 mm FUGA 4 mm



SUPB BAZA

ZA VEĆU VISINU +5 mm

VOKEL ŠIFRA	OPIS
<b>1694008</b>	PRODUŽETAK ZA POSTOLJE SUPT4 PODEŠAVANJE DO 30 mm MAX 3 SUPB



SUPAR PRSTEN

ZA PODIZANJE VISINE +30 mm

VOKEL ŠIFRA	OPIS
<b>1694003</b>	PRSTEN ZA PODIZANJE VISINE 3 cm, MOŽE SE KORISTITI POJEDINAČNO ILI VIŠE SUPAR (PRSTENOVA)



SUPAR120 PRSTEN

ZA PODIZANJE VISINE +120 mm

VOKEL ŠIFRA	OPIS
<b>1694004</b>	PRSTEN ZA PODIZANJE VISINE 12 cm, MOŽE SE KORISTITI POJEDINAČNO ILI VIŠE SUPAR (PRSTENOVA)



SUPA4 ZAVRŠNI KOMAD

FUGA 4 mm

VOKEL ŠIFRA	OPIS
<b>1694005</b>	DODATAK S GUMOM KOJA JAMČI SMANJENJE BUKE I PROTUKLIZNOST



SUPA2 ZAVRŠNI KOMAD

FUGA 2 mm

VOKEL ŠIFRA	OPIS
<b>1694006</b>	DODATAK S GUMOM KOJA JAMČI SMANJENJE BUKE I PROTUKLIZNOST

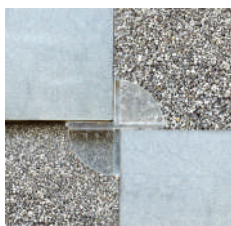

DISC10 ABS BAZA ZA POLAGANJE

FUGA 3 mm

VOKEL ŠIFRA	OPIS
<b>1694009</b>	BAZA ZA POLAGANJE FUGA 3 mm, H=10 mm NA PLOČICE, PRIRODNI KAMEN, ESTRIH



SUPACL PB DONJA KOPČA

ZA IZRADU OBODNIH RUBOVA

VOKEL ŠIFRA	OPIS
<b>1694010</b>	SPOJNICA KOJA SE POSTAVLJA NA PODNOŽJE NOSAČA ZA IZRADU OBODNIH RUBOVA S PROFILOM ILI PLOČICAMA



SUPACL PT GORNJA KOPČA

ZA IZRADU OBODNIH RUBOVA

VOKEL ŠIFRA	OPIS
<b>1694011</b>	SPOJNICA KOJA SE POSTAVLJA NA GLAVU NOSAČA ZA IZRADU OBODNIH RUBOVA S PROFILOM ILI PLOČICAMA



SUPACLPP ZIDNA KOPČA

PRIMJENJIVO NA SUPA2 I SUPA4

VOKEL ŠIFRA	OPIS
<b>1694012</b>	METALNA KOPČA ZA PRAVILNO RASPOREĐIVANJE NOSAČA KADA SE OSLANJAJU NA ZID



SUPAK KLJUČ ZA POSTOLJE

METALNI KLJUČ ZA PODEŠAVANJE

VOKEL ŠIFRA	OPIS
<b>1694013</b>	PODEŠAVANJE NA 3 NAČINA: 1.PROMJENA FIKSNE GLAVE NA SAMONIVELIRAJUĆU 2.UKLANJANJE BAZA ZA VEZIVANJE 3.PODEŠAVANJE VISINE



**UZORCI ZA POLAGANJE**

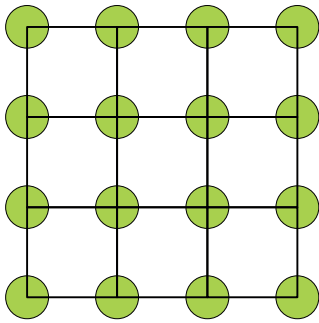

40x40 cm

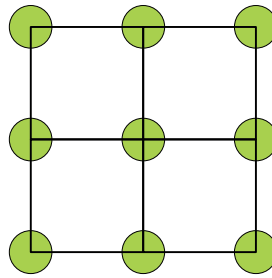

50x50 cm

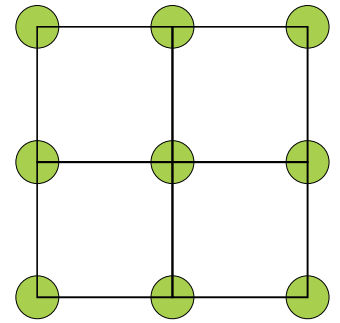

60x60 cm

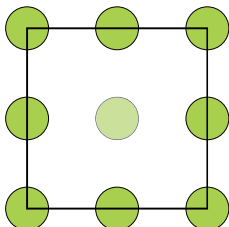

80x80 cm

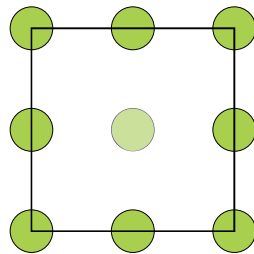

90x90 cm

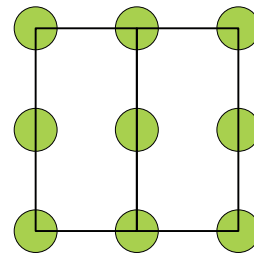

40x80 cm

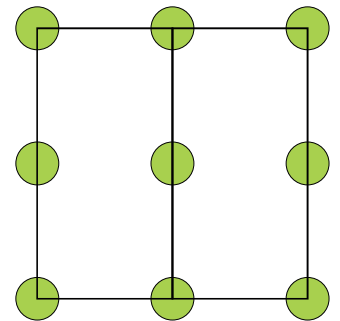

45x90 cm

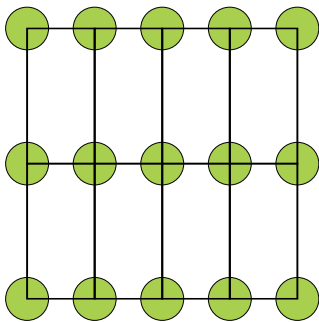

30x60 cm

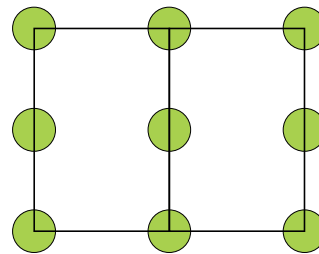

60x90 cm

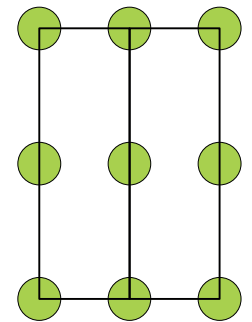

40x120 cm

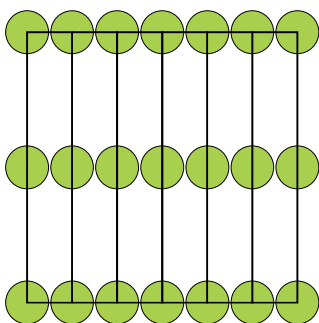

20x120 cm

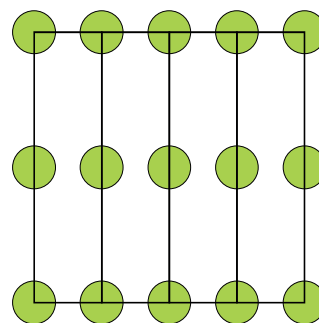

30x120 cm

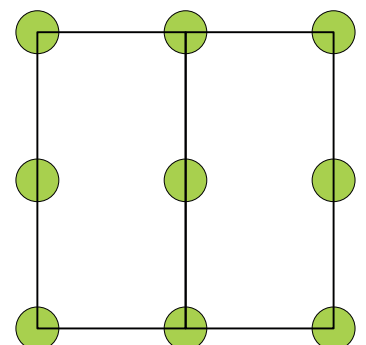

60x120 cm

POTROŠNJA NOSAČA NA m2

TILE SIZE	20	30	40	45	50	60	70	75	80	90	100
20	25	16,67	12,5	11,11	10	8,33	14,29	13,33	12,5	11,11	10
30	16,67	11,11	8,33	7,41	6,67	5,56	9,52	8,89	8,33	7,41	6,67
40	12,5	8,33	6,5	5,56	5	4,17	7,14	6,67	6,65	5,56	5
45	11,1	7,41	5,56	4,94	4,44	3,7	6,35	5,63	5,56	4,94	4,44
50	10	6,67	5	4,44	4	3,33	5,71	5,33	5	4,44	4
60	8,3	5,56	4,17	3,7	3,33	2,78	4,76	4,44	4,17	3,7	3,33
70	14,29	9,52	7,14	6,35	5,71	4,76	4,08	3,81	3,57	3,17	2,86
75	13,33	8,89	6,67	5,93	5,33	4,44	3,81	3,56	3,33	2,96	2,67
80	12,5	8,33	6,25	5,56	5	4,17	3,57	3,33	6,25	5,59	5
90	11,11	7,41	5,56	4,94	4,44	3,7	3,17	2,96	5,56	4,94	4,44
100	10	6,67	5	4,44	4	3,33	2,86	2,67	5	4,44	4
120	8,33	5,56	4,17	3,7	3,33	2,78	2,38	2,22	4,17	3,7	3,33
140	14,29	9,52	7,14	6,35	5,71	4,76	2,04	1,9	3,57	3,17	2,86
160	12,5	8,33	6,25	5,56	5	4,17	3,57	3,33	6,25	5,56	5
180	8,33	5,56	4,17	3,7	3,33	2,78	2,38	2,22	4,17	3,7	3,33

Tablica daje čisto matematičku procjenu potrošnje bez uzimanja u obzir svih varijabli lokacije. Preporučuje se da se navedene vrijednosti povećaju za 5-15%.



# LAPIS

KATALOG PROIZVODA





LAPIS GREY 80, 100 cm

PLOČA S UMIVAONIKOM

VOKEL ŠIFRA	OPIS	ARTIKAL
<b>1741001</b>	GORNJA PLOČA S UMIVAONIKOM LAPIS GREY 80x50x15 cm	AY01-80 (6008)
<b>1741003</b>	GORNJA PLOČA S UMIVAONIKOM LAPIS GREY 100x50x15 cm	AY01-100(6008)

PREPORUČENI NOSAČI ZA GORNJE PLOČE

VOKEL ŠIFRA	OPIS	PAKIRANJE (KOM)
<b>1196010</b>	NOSAČ PLOČE ZA UMIVAONIK TIP-L-450	2



LAPIS GREY 80, 100 cm

DONJA PLOČA

VOKEL ŠIFRA	OPIS	ARTIKAL
<b>1741002</b>	PLOČA S RUPOM LAPIS GREY 80x50x8 cm	AY01-80 (6008)
<b>1741004</b>	PLOČA S RUPOM LAPIS GREY 100x50x8 cm	AY01-100(6008)





LAPIS CALACCATA 80,100 cm

PLOČA S UMIVAONIKOM

VOKEL ŠIFRA	OPIS	ARTIKAL
<b>1741005</b>	GORNJA PLOČA S UMIVAONIKOM LAPIS CALACCATA 80x50x15 cm	AY01-80 (6001)
<b>1741007</b>	GORNJA PLOČA S UMIVAONIKOM LAPIS CALACCATA 100x50x15 cm	AY01-100 (6001)

PREPORUČENI NOSAČI ZA GORNJE PLOČE

VOKEL ŠIFRA	OPIS	PAKIRANJE (KOM)
<b>1196010</b>	NOSAČ PLOČE ZA UMIVAONIK TIP-L-450	2



LAPIS CALACCATA 80,100 cm

DONJA PLOČA

VOKEL ŠIFRA	OPIS	ARTIKAL
<b>1741006</b>	PLOČA S RUPOM LAPIS CALACCATA 80x50x8 cm	AY01-80 (6001)
<b>1741008</b>	PLOČA S RUPOM LAPIS CALACCATA 100x50x8 cm	AY01-100 (6001)







LAPIS CALACCATA GOLD 80,100 cm

PLOČA S UMIVAONIKOM

VOKEL ŠIFRA	OPIS	ARTIKAL
<b>1741009</b>	GORNJA PLOČA S UMIVAONIKOM LAPIS GOLD CALACCATA 80x50x15 cm	AY01-80 (6017)
<b>1741011</b>	GORNJA PLOČA S UMIVAONIKOM LAPIS GOLD CALACCATA 100x50x15 cm	AY01-100 (6017)

PREPORUČENI NOSAČI ZA GORNJE PLOČE

VOKEL ŠIFRA	OPIS	PAKIRANJE (KOM)
<b>1196010</b>	NOSAČ PLOČE ZA UMIVAONIK TIP-L-450	2



LAPIS CALACCATA GOLD 80,100 cm

DONJA PLOČA

VOKEL ŠIFRA	OPIS	ARTIKAL
<b>1741010</b>	PLOČA S RUPOM LAPIS GOLD CALACCATA 80x50x8 cm	AY01-80 (6017)
<b>1741012</b>	PLOČA S RUPOM LAPIS GOLD CALACCATA 100x50x8 cm	AY01-100 (6017)





**LAJSNE ZA KERAMIKU I PODNE OBLOGE**

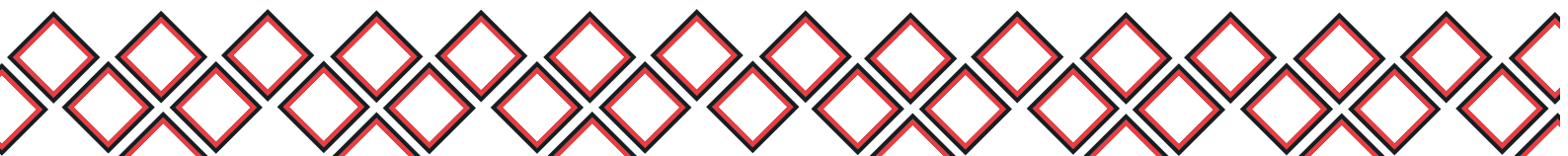

**STIQ LAJSNA**
**S810**

- Lajsna koja se koristi kod postavljanja keramike
- Materijal lajsne: stirplastika
- Karakteristike: vodootporna, otporna na udarce
- Ugradnja: montažno ljepilo

VOKEL ŠIFRA	BOJA	DUŽINA (m)	ARTIKAL
<b>1209001</b>	BIJELA	2,2	10545

**STIQ LAJSNA**
**S610**

- Lajsna koja se koristi kod postavljanja keramike
- Materijal lajsne: stirplastika
- Karakteristike: vodootporna, otporna na udarce
- Ugradnja: montažno ljepilo

VOKEL ŠIFRA	BOJA	DUŽINA (m)	ARTIKAL
<b>1209002</b>	BIJELA	2,2	10544

**STIQ XL LAJSNA**
**STX610**

- Lajsna koja se koristi za sve vrste podnih obloga
- Materijal lajsne: stirplastika
- Karakteristike: vodootporna, otporna na udarce
- Ugradnja: montažno ljepilo

VOKEL ŠIFRA	BOJA	DUŽINA (m)	ARTIKAL
<b>1209003</b>	BIJELA	2,2	10541

**STIQ LAJSNA**

S810

- Lajsna koja se koristi za sve vrste podnih obloga
- Materijal lajsne: stirplastika
- Karakteristike: vodootporna, otporna na udarce
- Ugradnja: montažno ljepilo

VOKEL ŠIFRA	BOJA	DUŽINA (m)	ARTIKAL
<b>1209004</b>	BIJELA	2,2	10542

**STIQ LAJSNA**

S610

- Lajsna koja se koristi za sve vrste podnih obloga
- Materijal lajsne: stirplastika
- Karakteristike: vodootporna, otporna na udarce
- Ugradnja: montažno ljepilo

VOKEL ŠIFRA	BOJA	DUŽINA (m)	ARTIKAL
<b>1209005</b>	BIJELA	2,2	10543

**STIQ XL LAJSNA**

STX610

- Lajsna koja se koristi kod postavljanja keramike
- Materijal lajsne: stirplastika
- Karakteristike: vodootporna, otporna na udarce
- Ugradnja: montažno ljepilo

VOKEL ŠIFRA	BOJA	DUŽINA (m)	ARTIKAL
<b>1209006</b>	BIJELA	2,4	10876

**PROFIFLOOR LAJSNA**

PF-6015

- Lajsna koja se koristi kod postavljanja keramike
- Materijal lajsne: stирplastika
- Karakteristike: vodootporna, otporna na udarce
- Ugradnja: montažno ljepilo

VOKEL ŠIFRA	BOJA	DUŽINA (m)	ARTIKAL
<b>1209007</b>	BIJELA	2,4	10875



# alca

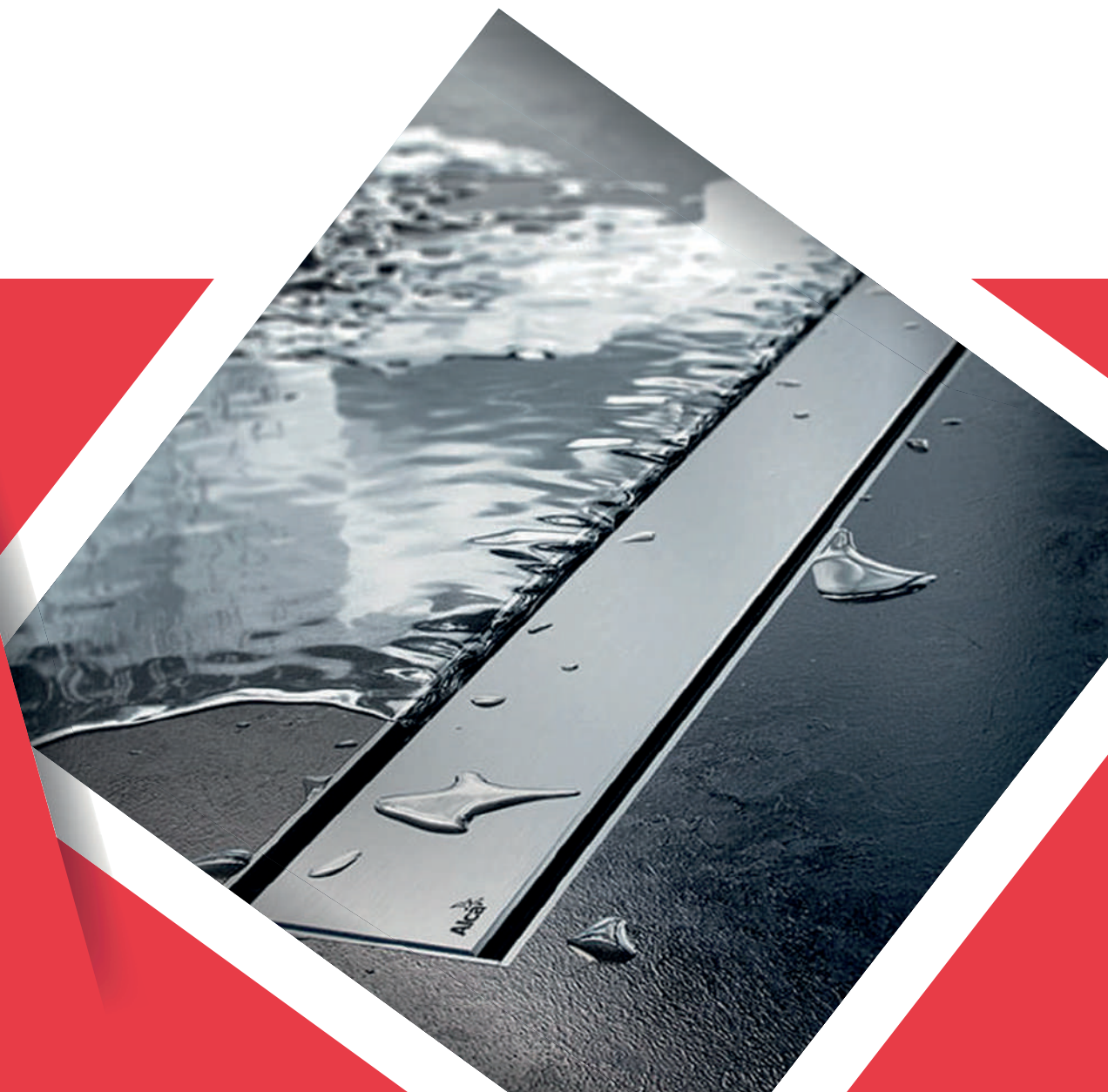



AGV1S  
OLUČNI SLIVNIK

ŠIFRA VOKEL	PAKIRANJE	ŠIFRA ARTIKLA
<b>0528253</b>	1	AGV1S

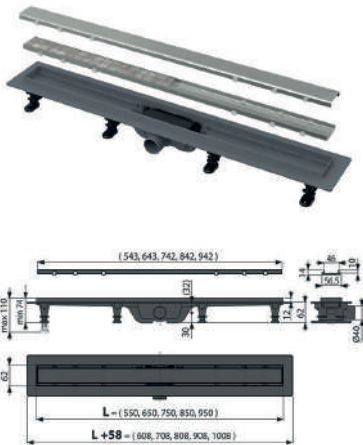
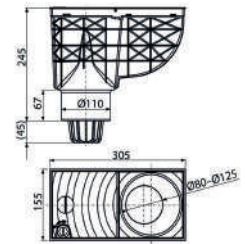

APZ19  
PVC TUŠ KANALICA S DVOSTRANOM INOX REŠETKOM

ŠIFRA VOKEL	DULJINA/mm	ŠIFRA ARTIKLA
<b>0528254</b>	550	APZ19-550
<b>0528255</b>	650	APZ19-650
<b>0528256</b>	750	APZ19-750
<b>0528257</b>	850	APZ19-850
<b>0528258</b>	950	APZ19-950



A55K-G-B  
SIFON ZA KADU-ZLATNI

ŠIFRA VOKEL	PAKIRANJE (kom)	DUŽINA POTEZNE SAJLE (cm)	ŠIFRA ARTIKLA
<b>0528259</b>	20	57	A55K-G-B

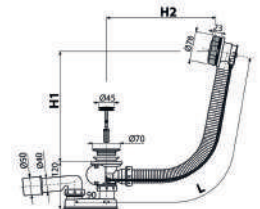

A55BLACK-80  
SIFON ZA KADU-CRNI MAT

ŠIFRA VOKEL	PAKIRANJE (kom)	DUŽINA POTEZNE SAJLE (cm)	ŠIFRA ARTIKLA
<b>0528260</b>	12	80	A55BLACK-80

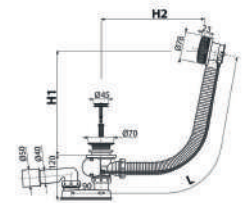

ŠIFRA VOKEL	BOJA	PAKIRANJE	ŠIFRA ARTIKLA
<b>0528261</b>	BIJELA	1	M1976

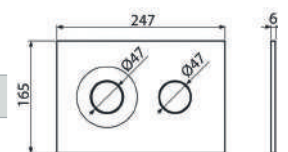

**\*\* Instalacija Easy serije je moguća isključivo ljepljenjem na zid (bez bušenja).**



### VJEŠALICA

45 x 45 x 31 mm

ŠIFRA VOKEL	BOJA	ŠIFRA ARTIKLA	PAKIRANJE
<b>1160176</b>	CRNA	163106360	1



### DRŽAČ WC PAPIRA

100 x 145 x 42 mm

ŠIFRA VOKEL	BOJA	ŠIFRA ARTIKLA	PAKIRANJE
<b>1160178</b>	CRNA	163112020	1



### DRŽAČ WC ČETKE

97 x 80 x 355 mm

ŠIFRA VOKEL	BOJA	ŠIFRA ARTIKLA	PAKIRANJE
<b>1160180</b>	CRNA	163113060	1



### DRŽAČ RUČNIKA

645 x 72 x 74 mm

ŠIFRA VOKEL	BOJA	ŠIFRA ARTIKLA	PAKIRANJE
<b>1160182</b>	CRNA	163104240	1



### VJEŠALICA

45 x 45 x 31 mm

ŠIFRA VOKEL	BOJA	ŠIFRA ARTIKLA	PAKIRANJE
<b>1160177</b>	KROM	163106361	1



**DRŽAČ WC PAPIRA**

100 x 145 x 42 mm

ŠIFRA VOKEL	BOJA	ŠIFRA ARTIKLA	PAKIRANJE
<b>1160179</b>	KROM	163112021	1



**DRŽAČ WC ČETKE**

97 x 80 x 355 mm

ŠIFRA VOKEL	BOJA	ŠIFRA ARTIKLA	PAKIRANJE
<b>1160181</b>	KROM	163113061	1



**DRŽAČ RUČNIKA**

645 x 72 x 74 mm

ŠIFRA VOKEL	BOJA	ŠIFRA ARTIKLA	PAKIRANJE
<b>1160183</b>	KROM	163104241	1



# KATALOG PROIZVODA





### VENTILATOR TEXO AIR PRO

ŠIFRA VOKEL	MODEL	BOJA	ŠIFRA ARTIKLA
<b>0527062</b>	AIR PRO 100-ZAKRIVLJENI	BIJELA	004-606
<b>0527072</b>	AIR PRO 120-ZAKRIVLJENI	BIJELA	004-616



### VENTILATOR TEXO AIR PRO

MOGUĆNOST BOJANJA

ŠIFRA VOKEL	MODEL	ŠIFRA ARTIKLA
<b>0527063</b>	AIR PRO 100	004-607
<b>0527073</b>	AIR PRO 120	004-617



### VENTILATOR TEXO AIR PRO

ŠIFRA VOKEL	MODEL	BOJA	ŠIFRA ARTIKLA
<b>0527064</b>	AIR PRO 100	SILVER	004-608
<b>0527074</b>	AIR PRO 120	SILVER	004-618



### VENTILATOR TEXO AIR PRO

ŠIFRA VOKEL	MODEL	BOJA	ŠIFRA ARTIKLA
<b>0527065</b>	AIR PRO 100	GOLD	004-609
<b>0527075</b>	AIR PRO 120	GOLD	004-619



### VENTILATOR TEXO AIR PRO

ŠIFRA VOKEL	MODEL	BOJA	ŠIFRA ARTIKLA
<b>0527066</b>	AIR PRO 100	SATEN	004-610
<b>0527076</b>	AIR PRO 120	SATEN	004-620

## VENTILATORI



### VENTILATOR TEXO AIR PRO

ŠIFRA VOKEL	MODEL	BOJA	ŠIFRA ARTIKLA
<b>0527067</b>	AIR PRO 100	KROM	004-611
<b>0527077</b>	AIR PRO 120	KROM	004-621



### VENTILATOR TEXO AIR PRO

ŠIFRA VOKEL	MODEL	BOJA	ŠIFRA ARTIKLA
<b>0527068</b>	AIR PRO 100-RAVNI	BIJELA	004-612
<b>0527078</b>	AIR PRO 120-RAVNI	BIJELA	004-622



### VENTILATOR TEXO AIR PRO

ŠIFRA VOKEL	MODEL	BOJA	ŠIFRA ARTIKLA
<b>0527069</b>	AIR PRO 100	BIJELO STAKLO	004-613
<b>0527079</b>	AIR PRO 120	BIJELO STAKLO	004-623



### VENTILATOR TEXO AIR PRO

ŠIFRA VOKEL	MODEL	BOJA	ŠIFRA ARTIKLA
<b>0527070</b>	AIR PRO 100	CRNO STAKLO	004-614
<b>0527080</b>	AIR PRO 120	CRNO STAKLO	004-624



### VENTILATOR TEXO AIR PRO

#### POSTAVLJANJE PLOČICE

ŠIFRA VOKEL	MODEL	BOJA	ŠIFRA ARTIKLA
<b>0527071</b>	AIR PRO 100	CRNA	004-615
<b>0527081</b>	AIR PRO 120	CRNA	004-625



## VENTILATOR TEXO AIR PRO

ZAKRIVLJENI S TAJMEROM

ŠIFRA VOKEL	MODEL	BOJA	ŠIFRA ARTIKLA
<b>0527082</b>	AIR PRO 120	BIJELA	004-626

**CU CIJEV S UV IZOLACIJOM ZA KLIME**

VOKEL ŠIFRA	DIMENZIJA (")	DIMENZIJA (mm)	ARTIKAL
<b>1477017</b>	1/4"	6,35x0,8	2FR99A307001Q1450
<b>1477018</b>	3/8"	9,52x0,8	2FR99A307101Q1490
<b>1477019</b>	1/2"	12,7x0,8	2FR99A303701Q1530
<b>1477020</b>	5/8"	15,87x0,8	2FR99A307701Q1590



**Sjedište tvrtke** BiH

**Vokel d.o.o.**  
 📍 Vinjani b.b.  
 88240 Posušje  
 ☎ +387 39 693 001  
 ✉ vokel@vokel.com

**Podružnica** HR

Vokel d.o.o. Imotski  
 📍 Bleiburška ulica 131, 21260 Imotski  
 ☎ +385 21 582 427  
 ✉ vokel@vokel.com

**Vokel partner** MNE

Feroplet d.o.o. Vokel partner  
 📍 Druge Dalmatinske 5, 85340 Herceg Novi  
 ☎ +382 31 580 052  
 ✉ office@feroplet.me

**Podružnice:** BiH

**Vokel d.o.o. Sarajevo**  
 📍 Kurta Schorka 5a-Stup  
 ☎ +387 33 768 605  
 ✉ sarajevo@vokel.com

**Vokel d.o.o. Prijedor**  
 📍 Svale b.b.  
 ☎ +387 52 243 810  
 ✉ prijedor@vokel.com

**Vokel d.o.o. Jajce**  
 📍 Skela b.b.  
 ☎ +387 30 654 088  
 ✉ jajce@vokel.com

**Vokel d.o.o. Brčko**  
 📍 Grbavica b.b.  
 ☎ +387 49 213 874  
 ✉ brcko@vokel.com

**Vokel d.o.o. Bosanska Krupa**  
 📍 Unska b.b.  
 ☎ +387 37 489 589  
 ✉ bosanskakrupa@vokel.com

**Vokel d.o.o. Bihać**  
 📍 Pritoka b.b.  
 ☎ +387 37 328 128  
 ✉ bihac@vokel.com

**Vokel d.o.o. Bijeljina**  
 📍 Ljeljenča b.b.  
 ☎ +387 55 256 050  
 ✉ bijeljina@vokel.com

**Vokel d.o.o. Livno**  
 📍 Župana Želimira b.b.  
 ☎ +387 34 202 665  
 ✉ livno@vokel.com

**Vokel d.o.o. Trn-Laktaši**  
 📍 Cara Dušana 74  
 ☎ +387 51 507 300  
 ✉ banjaluka@vokel.com

**Vokel d.o.o. Tuzla**  
 📍 Mitra Trifunovića Uče 1  
 ☎ +387 35 398 580  
 ✉ tuzla@vokel.com

**Vokel d.o.o. Mostar**  
 📍 Bišće polje b.b.  
 ☎ +387 36 351 900  
 ✉ mostar@vokel.com

**Vokel d.o.o. Trebinje**  
 📍 Todorići b.b.  
 ☎ +387 59 490 210  
 ✉ trebinje@vokel.com

**Vokel d.o.o. Sanski Most**  
 📍 Bulevar 7. Korpusa b.b.  
 ☎ +387 37 681 134  
 ✉ sanskimost@vokel.com

