



DOPUNSKI KATALOG

Cijeli svijet na jednom mjestu!

KERAMIKA | SANITARIJE | KLIMATIZACIJA | VODOMATERIJAL
CENTRALNO GRIJANJE | LAMINATI I PARKETI

2024

Veleprodaja i maloprodaja

02.10.2024



Vinjani bb, 88240 Posušje
Bosna i Hercegovina
www.vokel.com



<p>ACQUADANCE</p>		<p>Acquadance str.1</p>
<p><i>Biamante</i></p>		<p>Biamante str.6</p>
<p>RAINBOW</p>		<p>Rainbow str.13</p>
<p>ceramicatecla italian luxury washbasins</p>		<p>Ceramica Tecla str.16</p>
<p>MIFONTE</p>		<p>Mifonte str.17</p>
<p>BiAL EVERYTHING IN PLACE</p>		<p>Bial str.27</p>
<p>FIN KUPAONSKI RADIJATORI</p>		<p>Fin str.29</p>
		<p>Terma str.30</p>

 <p>bellavia QUALITY FOR LIFE</p>		<p>Bellavia str.31</p>
<p>QUADRO & BELLA</p>		<p>Quadro i Bella str.41</p>
 <p>GRUNDFOS</p>		<p>Grundfos str.42</p>
 <p>IMPPUMPS Intelligent Motor Pumps</p>		<p>Impumps str.44</p>
 <p>kratki</p>		<p>Kratki str.45</p>
 <p>PROGETTO IDEA STELLA</p>		<p>Progetto Idea Stella str.61</p>
 <p>Melody</p>		<p>Melody str.69</p>
<p>aquaart WHERE INSPIRATION FLOWS</p>		<p>Aquaart str.75</p>

<p>Royo[®]</p>		<p>Royo str.83</p>
<p>JIKA Czech Bathrooms since 1878</p>		<p>Jika str.84</p>
<p>Roca</p>		<p>Roca str.85</p>
<p>PONTE GIULIO[®] creating solutions</p>		<p>Ponte Giulio str.87</p>
<p>Garcia</p>		<p>Garcia str.88</p>
<p> UNITAS[®]</p>		<p>Unitas str.92</p>
<p>HARO[®]</p>		<p>Haro str.94</p>
<p></p>		<p>Aqua Filter str.97</p>

<p>gorenje</p>		<p>Gorenje str.98</p>
<p>KONČAR</p>		<p>Končar str.100</p>
		<p>Ariston str.101</p>
		<p>Dakota str.106</p>
		<p>Vecamco str.108</p>
		<p>Dab str.112</p>
		<p>Kovina str.113</p>

		<p>Danfoss str.114</p>
		<p>C-Mix str.117</p>
		<p>Profilpas str.119</p>
		<p>Feal str.133</p>
		<p>It-Flex str.141</p>
		<p>Izoterm str.143</p>
		<p>Vaillant str.144</p>
		<p>Centrometal str.153</p>

		<p>Thermoflux str.156</p>
		<p>Soprema str.157</p>
		<p>Aquasystem str.159</p>
		<p>Solar str.162</p>
		<p>Kan str.164</p>
		<p>Caleffi str.168</p>
		<p>Itap str.169</p>
		<p>Imi Heimeier str.170</p>

<h1>AXA</h1>		<p>Axa str.172</p>
		<p>Impertek str.173</p>
		<p>Neoperl str.176</p>
		<p>Arco str.192</p>
		<p>Fitt str.195</p>
		<p>Swiss Aqua str.196</p>
<h1>REMER</h1> <p>RUBINETTERIE</p>		<p>Remer str.197</p>
		<p>Ikom str.206</p>

		<p>Fiorini str.208</p>
		<p>Weltplast str.221</p>
		<p>Peštan str.227</p>
		<p>Windy Plus str.232</p>
<p>L-CLASSIC WC ŠKOLJKE I UMIVAONICI</p>		<p>L-CLASSIC str.233</p>
		<p>Unitas str.234</p>
		<p>Elbi str.235</p>
		<p>Aria str.238</p>

<p><i>Biamante</i></p>		<p>Biamante str.247</p>
<p><u>herstone</u></p>		<p>Herstone str.255</p>
		<p>Argo str.256</p>
		<p>Sonniger str.276</p>
		<p>Digisu str.281</p>
<p>Klick & Hitze</p>		<p>Klick & Hitze str.282</p>
		<p>Engo str.287</p>
		<p>Roca str.293</p>

		<p>Martat str.295</p>
		<p>Elba str.304</p>
		<p>Aria str.310</p>
		<p>Max alati str.327</p>
		<p>Sika str.343</p>
		<p>Arceus termoblok str.348</p>
		<p>Aspecto str.351</p>
		<p>Grohe str.353</p>

		<p>Alati za keramičare str.360</p>
<p>Klick & Hitze</p>		<p>Odvajač nečistoća str.372</p>
<p>Aria^A</p>		<p>Aria A str.373</p>
		<p>Nagai str.377</p>
		<p>Heatsense str.381</p>
		<p>Profilitec str.385</p>
<p>LAPIS</p>		<p>Lapis str.390</p>

		<p>Oluk str.396</p>
<p>alcadrain</p>		<p>Alcadrain str.400</p>
<p>BEMETA</p>		<p>Bemeta str.402</p>
		<p>Liberama str.404</p>
		<p>Cuprumfoma str.408</p>
<p>ZOREX TRADE</p>		<p>Zorex str.409</p>

ALAMERE



KARAKTERISTIKE:

- Tri odvojena prebacivača, mesingana slavina i termostatska baterija
- Dimenzija: 160x20cm
- Zlatna završna obrada, nehrđajući čelik 304
- Uključen: ugrađen gornji tuš kromirani i dvije mlaznice, tuš ručica i držač tuš ručice, 2x40cm fleksibilno crijevo, 1,5m tuš crijevo

VOKEL ŠIFRA	BOJA	DIMENZIJA (cm)	ARTIKAL
1703001	ZLATNA	160 x 20	ST-88256

SELFOSS



KARAKTERISTIKE:

- Jedan prebacivač za tri načina i mesingana baterija
- Dimenzija: 160x20cm
- Crna završna obrada, nehrđajući čelik 304
- Uključen: gornji tuš kromirani i dvije mlaznice, tuš ručica i držač tuš ručice, 2x40cm fleksibilno crijevo

VOKEL ŠIFRA	BOJA	DIMENZIJA (cm)	ARTIKAL
1703002	CRNA	160 x 20	ST-88251

GULLFOSS

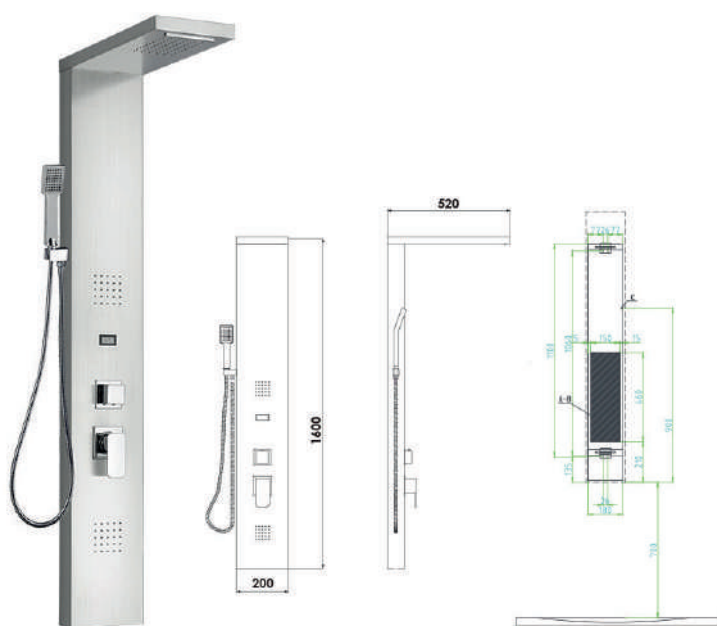

KARAKTERISTIKE:

- Jedan prebacivač za četiri načina, mesingana baterija i termometar
- Dimenzija: 140x20cm
- Završna obrada brušeni nehrđajući čelik
- Uključen: gornji tuš kromirani i vodopad, dvije mlaznice, tuš ručica i držač tuš ručice, 2x40cm, fleksibilno crijevo, 1,5m tuš crijevo

VOKEL ŠIFRA	BOJA	DIMENZIJA (cm)	ARTIKAL
1703003	KROM	140 x 20	ST-88235

LAHA

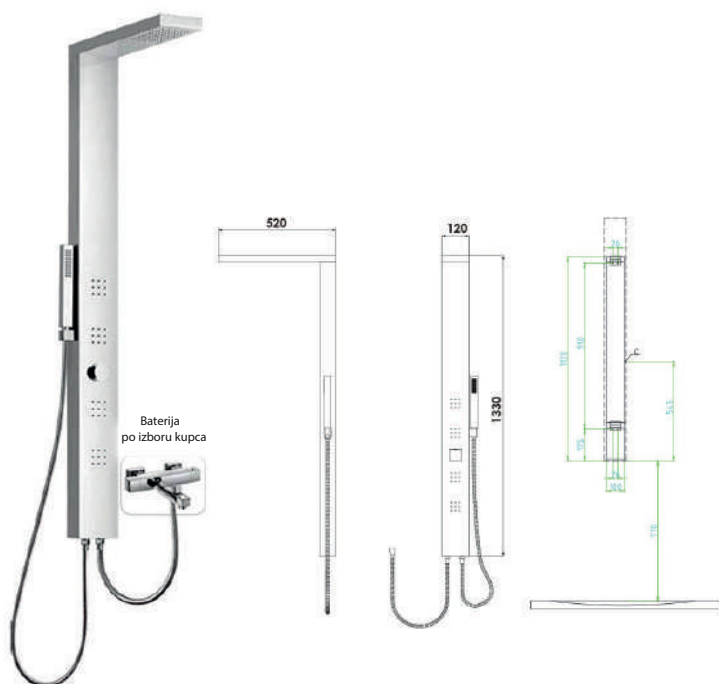

KARAKTERISTIKE:

- Jedan prebacivač za tri načina, bez baterije
- Dimenzija: 133x12cm
- Završna obrada brušeni nehrđajući čelik
- Uključen: gornji tuš i četiri mlaznice, tuš ručica i držač tuš ručice, 60cm fleksibilno crijevo, 1,5m tuš crijevo

VOKEL ŠIFRA	BOJA	DIMENZIJA (cm)	ARTIKAL
1703004	KROM	133 x 12	ST-88114

GRAND

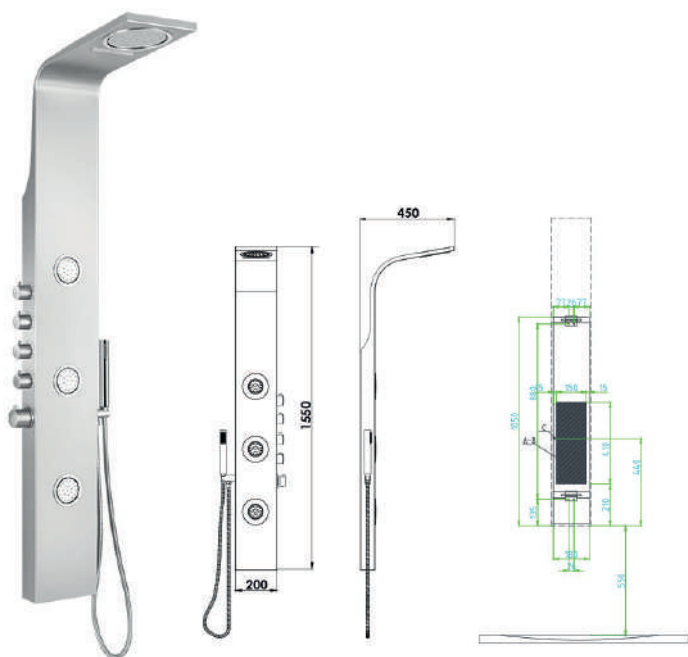

KARAKTERISTIKE:

- Četiri odvojena prebacivača i mesingana baterija
- Dimenzija: 155x20cm
- Završna obrada brušeni nehrđajući čelik
- Uključen: gornji tuš i vodopad, tri mlaznice, tuš ručica i držač tuš ručice, 2x40cm fleksibilno crijevo, 1,5m tuš crijevo

VOKEL ŠIFRA	BOJA	DIMENZIJA (cm)	ARTIKAL
1703005	KROM	155 x 20	ST-88166

VIRGINIA

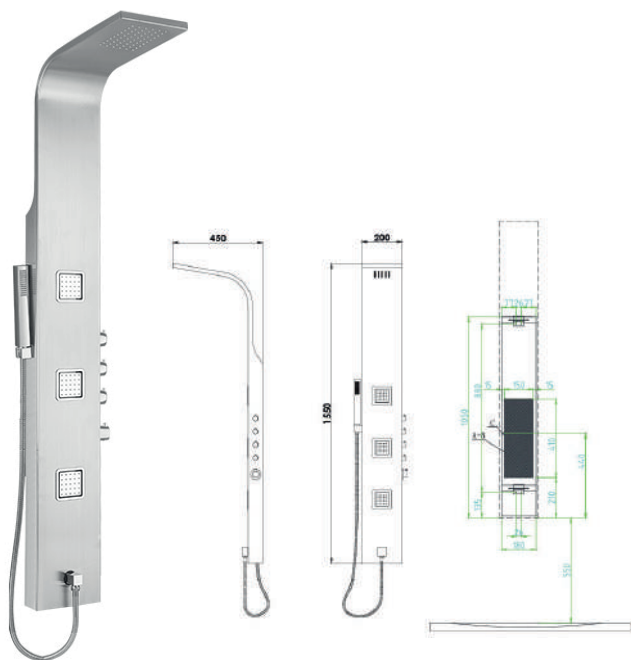

KARAKTERISTIKE

- Tri odvojena prebacivača i mesingana baterija
- Dimenzija: 155x20cm
- Završna obrada brušeni nehrđajući čelik
- Uključen: gornji tuš i tri mlaznice, tuš ručica i držač tuš ručice, 2x40cm flexibilno crijevo, 1,5m tuš crijevo

VOKEL ŠIFRA	BOJA	DIMENZIJA (cm)	ARTIKAL
1703006	KROM	155 x 20	ST-88161

INGA



KARAKTERISTIKE:

- Multifunkcionalni prebacivač, mesingana baterija i izljev
- Dimenzija: 150x20cm
- Završna obrada brušeni nehrđajući čelik
- Uključen: gornji tuš s 50 mlaznica, ugrađene 2 mlaznice, tuš ručica i držač tuš ručice, 2x40cm fleksibilno crijevo, 1,5m tuš crijevo

VOKEL ŠIFRA	BOJA	DIMENZIJA (cm)	ARTIKAL
1703007	KROM	150 x 20	ST-8839

BIGAR

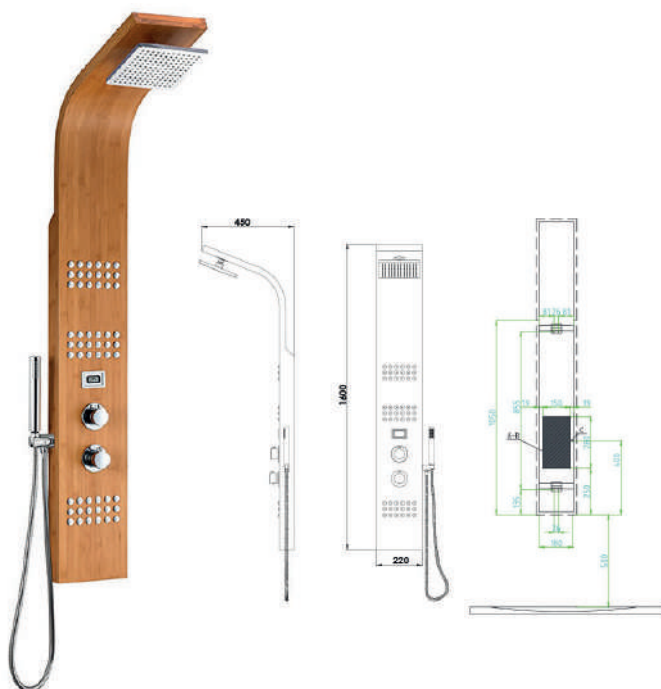

KARAKTERISTIKE:

- Jedan prebacivač za četiri načina, mesingana termostatska baterija i termometar
- Dimenzija: 160x22cm
- Materijal: bambus s vododtpornim premazom
- Uključen: ugrađen gornji tuš i tri mlaznice, tuš ručica, držač tuš ručice, 2x40cm fleksibilno crijevo, 1,5m tuš crijevo

VOKEL ŠIFRA	BOJA	DIMENZIJA (cm)	ARTIKAL
1703008	DRVO	160 x 22	ST-8311

TUŠ RUŽA - OKRUGLA



VOKEL ŠIFRA	DIMENZIJA (Ø)	BOJA	ARTIKAL
1703010	20	KROM	ST-601
1703011	25	KROM	ST-616
1703013	30	KROM	ST-603

TUŠ RUŽA - ČETVRTASTA

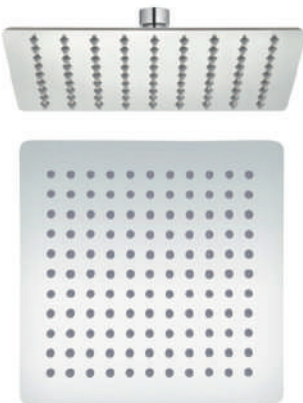

VOKEL ŠIFRA	DIMENZIJA (cm)	BOJA	ARTIKAL
1703009	20x20	KROM	ST-615
1703012	25x25	KROM	ST-617
1703014	30x30	KROM	ST-611

NIRVANA

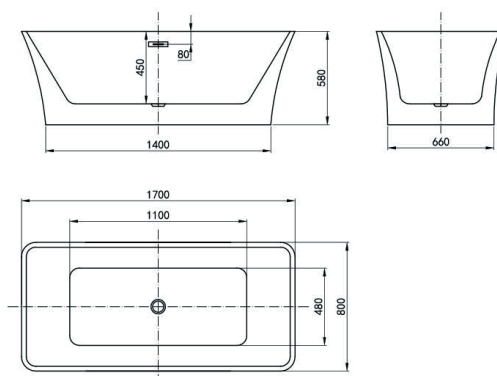

- samostojeća kada
- s gornjim dijelom sifona i preljevnom garniturom

ŠIFRA VOKEL
1705001

DIMENZIJA
170x80x58/O

MATERIJAL
AKRIL

BOJA
BIJELA

ARTIKAL
GD-8120

ARABICA

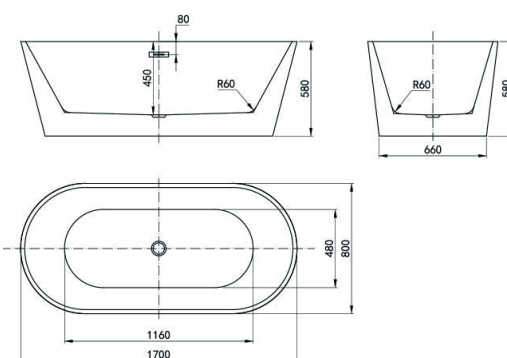

- samostojeća kada
- s gornjim dijelom sifona i preljevnom garniturom

ŠIFRA VOKEL
1705002

DIMENZIJA
170x80x58/O

MATERIJAL
AKRIL

BOJA
BIJELA

ARTIKAL
GD-8201

ARABICA BLACK

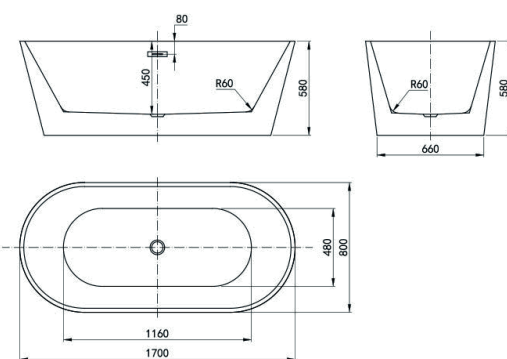

- samostojeća kada
- s gornjim dijelom sifona i preljevnom garniturom

ŠIFRA VOKEL
1705003

DIMENZIJA
170x80x58/O

MATERIJAL
AKRIL

BOJA
CRNA

ARTIKAL
GD-8120WB

ZENONA

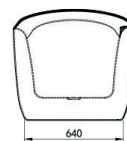
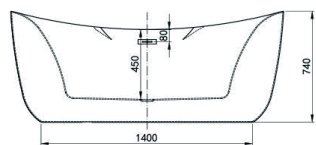

- samostojeća kada
- s gornjim dijelom sifona i preljevnom garniturom

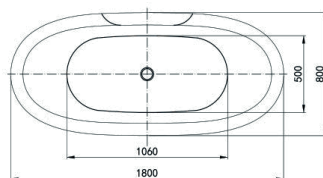

ŠIFRA VOKEL

DIMENZIJA

MATERIJAL

BOJA

ARTIKAL

1705004

180x80x74/O

AKRIL

BIJELA

GD-8305

LAMIA LIJEVA

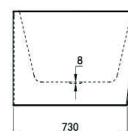
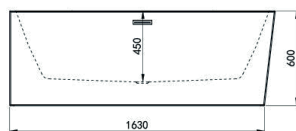

- samostojeća kada
- s gornjim dijelom sifona i preljevnom garniturom

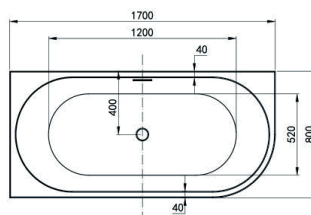

ŠIFRA VOKEL

DIMENZIJA

MATERIJAL

BOJA

ARTIKAL

1705005

170x80x60/O

AKRIL

BIJELA

GD-8312L

LAMIA DESNA

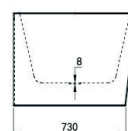
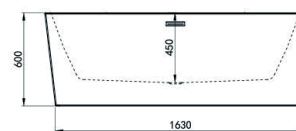

- samostojeća kada
- s gornjim dijelom sifona i preljevnom garniturom

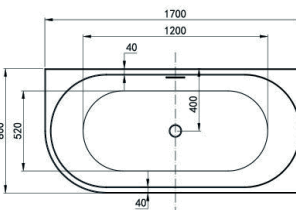

ŠIFRA VOKEL

DIMENZIJA

MATERIJAL

BOJA

ARTIKAL

1705006

170x80x60/O

AKRIL

BIJELA

GD-8312R

MARIS WHITE

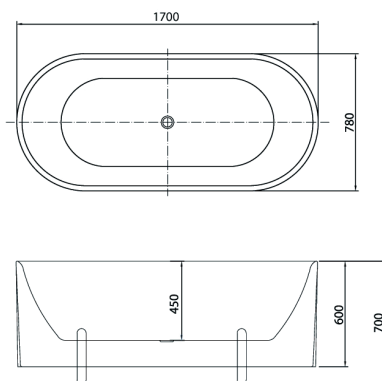

- samostojeća kada
- s gornjim dijelom sifona, prelivnom garniturom i ukrasnim nogama

ŠIFRA VOKEL
1730002

DIMENZIJA
170x78x70

MATERIJAL
AKRIL

BOJA
BIJELA

ARTIKAL
158778W

MARIS GREY

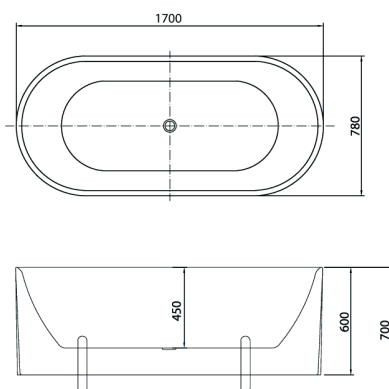

- samostojeća kada
- s gornjim dijelom sifona, prelivnom garniturom i ukrasnim nogama

ŠIFRA VOKEL
1730001

DIMENZIJA
170x78x70

MATERIJAL
AKRIL

BOJA
SIVA

ARTIKAL
158778G/W

EVIAN WHITE

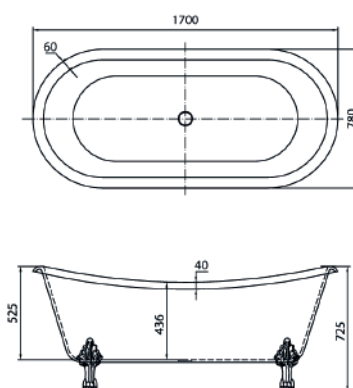

- samostojeća kada
- s uključenim sifonom i ukrasnim silver nogama

ŠIFRA VOKEL
1730003

DIMENZIJA
170x78x72,5

MATERIJAL
AKRIL

BOJA
BIJELA

ARTIKAL
EB05778W

EVIAN GREY

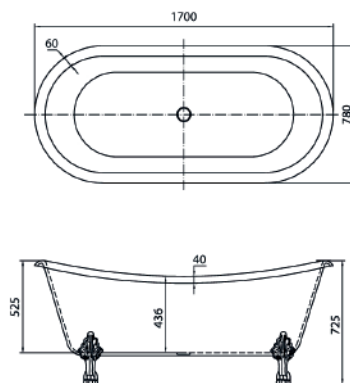

- samostojeća kada
- s uključenim sifonom i ukrasnim silver nogama

ŠIFRA VOKEL
1730004

DIMENZIJA
170x78x72,5

MATERIJAL
AKRIL

BOJA
SIVA

ARTIKAL
EB05778G/W

GAELA WHITE

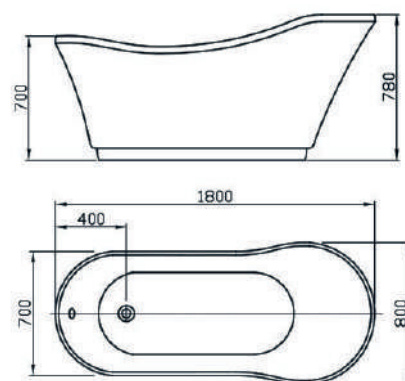

- samostojeća kada
- s gornjim dijelom sifona i preljevnom garniturom

ŠIFRA VOKEL
1729012

DIMENZIJA
180x78x78

MATERIJAL
AKRIL

BOJA
BIJELA

ARTIKAL
PY180-98

GAELA BLACK

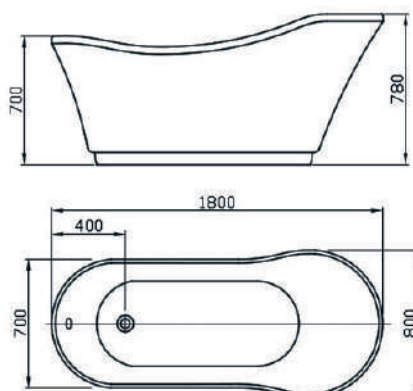

- samostojeća kada
- s gornjim dijelom sifona i preljevnom garniturom

ŠIFRA VOKEL
1729011

DIMENZIJA
180x78x78

MATERIJAL
AKRIL

BOJA
CRNA

ARTIKAL
PY180-98B

FREA BEIGE

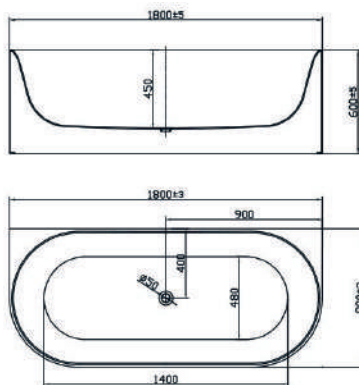

- samostojeća kada
- s gornjim dijelom sifona i preljevnom garniturom

ŠIFRA VOKEL

1729013

DIMENZIJA

180x80x60

MATERIJAL

AKRIL

BOJA

BIGE

ARTIKAL

PY180-104

MANDY WHITE



- lijevani mramor
- tuš kada s pokrovom matte-white
- za instalaciju na pod
- H = 3cm

ŠIFRA VOKEL	DIMENZIJA	BOJA	ARTIKAL
1729001	90x90	WHITE	MDXF12-MW
1729022	100x80	WHITE	MXDF12-MW
1729023	100x90	WHITE	MXDF12-MW
1729024	110x80	WHITE	MXDF12-MW
1729025	110x90	WHITE	MXDF12-MW
1729002	120x80	WHITE	MXDF12-MW
1729003	120x90	WHITE	MXDF12-MW
1729004	140x80	WHITE	MXDF12-MW
1729005	140x90	WHITE	MXDF12-MW
1729026	160x80	WHITE	MXDF12-MW
1729027	160x90	WHITE	MXDF12-MW

Preporučeni sifon:

0404440	SIFON FI 90 ZA TUŠ KADE, BEZ POKROVA H=65 mm	ART.563180
----------------	--	------------

MANDY BLACK



- lijevani mramor
- tuš kada s pokrovom matte-black
- za instalaciju na pod
- H = 3cm

ŠIFRA VOKEL	DIMENZIJA	BOJA	ARTIKAL
1729006	90x90	BLACK	MDXF12-MB
1729028	100x80	BLACK	MXDF12-MB
1729029	100x90	BLACK	MXDF12-MB
1729030	110x80	BLACK	MXDF12-MB
1729031	110x90	BLACK	MXDF12-MB
1729007	120x80	BLACK	MXDF12-MB
1729008	120x90	BLACK	MXDF12-MB
1729009	140x80	BLACK	MXDF12-MB
1729010	140x90	BLACK	MXDF12-MB
1729032	160x80	BLACK	MXDF12-MB
1729033	160x90	BLACK	MXDF12-MB

Preporučeni sifon:

0404440	SIFON FI 90 ZA TUŠ KADE, BEZ POKROVA H=65 mm	ART.563180
----------------	--	------------

MANDY GREY



- lijevani mramor
- tuš kada s pokrovom matte-grey
- za instalaciju na pod
- H = 3cm

ŠIFRA VOKEL	DIMENZIJA	BOJA	ARTIKAL
1729014	90x90	GREY	MXDF12-MG
1729034	100x80	GREY	MXDF12-MG
1729035	100x90	GREY	MXDF12-MG
1729036	110x80	GREY	MXDF12-MG
1729037	110x90	GREY	MXDF12-MG
1729015	120x80	GREY	MXDF12-MG
1729016	120x90	GREY	MXDF12-MG
1729017	140x80	GREY	MXDF12-MG
1729018	140x90	GREY	MXDF12-MG
1729038	160x80	GREY	MXDF12-MG
1729039	160x90	GREY	MXDF12-MG

Preporučeni sifon:

0404440	SIFON FI 90 ZA TUŠ KADE, BEZ POKROVA H=65 mm	ART.563180
----------------	--	------------

POKROV ZA TUŠ KADU MANDY WHITE



ŠIFRA VOKEL	DIMENZIJA	BOJA
1729021	15x15	WHITE

POKROV ZA TUŠ KADU MANDY BLACK



ŠIFRA VOKEL	DIMENZIJA	BOJA
1729020	15x15	BLACK

POKROV ZA TUŠ KADU MANDY GREY



ŠIFRA VOKEL	DIMENZIJA	BOJA
1729019	15x15	GREY

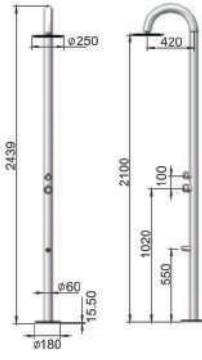

Rainbow

ML9007

Visina 2439 mm

Promjer 60 mm

Tuš ruža promjera 250 mm

Mat završna obrada

Š. VOKEL

OPIS

1192003

VANJSKI TUŠ RAINBOW ART.ML9007

Rainbow Black

ML9007-MB

Visina 2439 mm

Promjer 60 mm

Tuš ruža promjera 250 mm

Boja - crna

Mat završna obrada

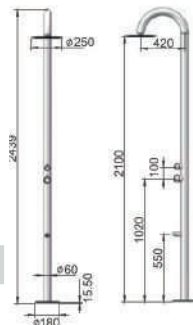

Š. VOKEL

OPIS

1192002

VANJSKI TUŠ RAINBOW ART.ML9007-MB



KARTUŠA

Š. VOKEL	OPIS	ART.
1723001	KARTUŠA ZA ML9007 I ML9007-MB	50001



PREBACIVAČ

Š. VOKEL	OPIS	ART.
1723002	PREBACIVAČ ZA ML9007 I ML9007-MB	50002



RUČICA ZA KARTUŠU

Š. VOKEL	OPIS	ART.
1723003	RUČICA ZA KARTUŠU ZA ML9007	50003



RUČICA ZA PREBACIVAČ

Š. VOKEL	OPIS	ART.
1723004	RUČICA ZA PREBACIVAČ ZA ML9007	50004



TUŠ RUŽA Ø 25 ZA ML9007

Š. VOKEL	OPIS	ART.
1723005	TUŠ RUŽA ZA ML9007	50005



RUČICA ZA KARTUŠU BLACK

Š. VOKEL	OPIS	ART.
1723006	RUČICA ZA KARTUŠU BLACK ZA ML9007-MB	50006



RUČICA ZA PREBACIVAČ

Š. VOKEL	OPIS	ART.
1723007	RUČICA ZA PREBACIVAČ BLACK ZA ML9007-MB	50007



TUŠ RUŽA Ø 25

Š. VOKEL	OPIS	ART.
1723008	TUŠ RUŽA BLACK ZA ML9007-MB	50008

RAINBOW VANJSKI TUŠ ML9007 INSTALACIJA

1 ODREĐITI POZICIJU UGRADNICE C-box-a U ODNOSU NA MJESTO TUSIRANJA (udaljenost između njih je 750 mm), NAPRAVITI RUPU NA OSNOVU VELIČINE C-box-a.

2 SPOJITI CIJEVI TOPLI I HLADNE VODE NA UGRADENI C-box, PROUVJERITI SPOJENJE DA NE PUSTAJU VODU.

3

Osigurajte da je C-box vertikalno i centrirano prema Vama. Pričvrstite C-box u rupu na dnu sa 4 ekspanzijska vijka MB, pobrinite se da podne pločice budu više od donje linije i niže od srednje linije C-box-a.

4

5

6

Umetnite gornju cijev u donju cijev, sa stražnje strane na dvije cijevi poklopi da dobijemo jedan pravokutnik, zavijte vijak na stražnjoj strani cijevi kako biste dobili ispravnu instalaciju. Priključite ručni tuš s fleksibilnim crijevom ako ga imate. (ako stavke imaju izljev, imajte na umu da smo ga već instalirali.)

TWENTY

UMIVAONIK TWENTY TOTAL BOWL

Š.VOKEL	DIMENZIJE	BOJA	ŠIFRA ARTIKLA	PAKIRANJE
1195001	46x61	BIJELA	TW01011	1
1195005	46x81	BIJELA	TW05011	1
1195009	46x101	BIJELA	TW09011	1
1195013	46x121	BIJELA	TW13011	1

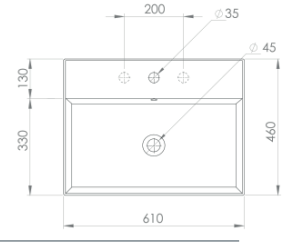

UMIVAONIK TWENTY CENTRAL BOWL

SREDNJI

Š.VOKEL	DIMENZIJE	BOJA	ŠIFRA ARTIKLA	PAKIRANJE
1195002	46x61	BIJELA	TW02011	1
1195006	46x81	BIJELA	TW06011	1
1195010	46x101	BIJELA	TW10011	1
1195014	46x121	BIJELA	TW14011	1

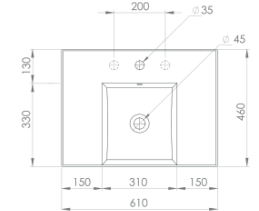

UMIVAONIK TWENTY RIGHT BOWL

DESNI

Š.VOKEL	DIMENZIJE	BOJA	ŠIFRA ARTIKLA	PAKIRANJE
1195003	46x61	BIJELA	TW03011	1
1195007	46x81	BIJELA	TW07011	1
1195011	46x101	BIJELA	TW11011	1
1195015	46x121	BIJELA	TW15011	1

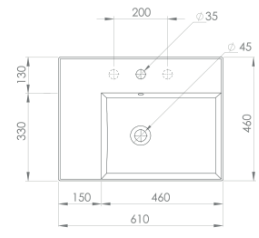

UMIVAONIK TWENTY LEFT BOWL

LIJEVI

Š.VOKEL	DIMENZIJE	BOJA	ŠIFRA ARTIKLA	PAKIRANJE
1195004	46x61	BIJELA	TW04011	1
1195008	46x81	BIJELA	TW08011	1
1195012	46x101	BIJELA	TW12011	1
1195016	46x121	BIJELA	TW16011	1

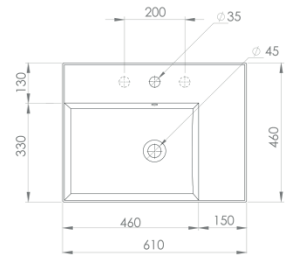

UMIVAONIK TWENTY DOUBLE BOWL- DUPLI

121cm

Š.VOKEL	DIMENZIJE	BOJA	ŠIFRA ARTIKLA	PAKIRANJE
1195017	46x121	BIJELA	TW17011	1

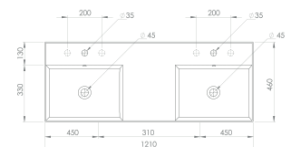

Š.VOKEL	OPIS
1196003	NOSAČ UMIVAONIKA INOX TIP - 800 B. T. P mod. TWENTY
1196002	NOSAČ UMIVAONIKA INOX TIP - 1000 B.T.P mod. TWENTY
1196001	NOSAČ UMIVAONIKA INOX TIP - 1200 B.T.P mod. TWENTY
1196006	NOSAČ UMIVAONIKA CRNI TIP - 800 B. T. P mod. TWENTY
1196005	NOSAČ UMIVAONIKA CRNI TIP - 1000 B. T. P mod. TWENTY
1196004	NOSAČ UMIVAONIKA CRNI TIP - 1200 B. T. P mod. TWENTY

Š.VOKEL	OPIS
1704001	POLICA BIANCHISSIMO QUARELLA 2cm 81 TWENTY (2ND)
1704002	POLICA BIANCHISSIMO QUARELLA 2CM 101 TWENTY (2ND)
1704003	POLICA BIANCHISSIMO QUARELLA 2cm 121 TWENTY (2ND)



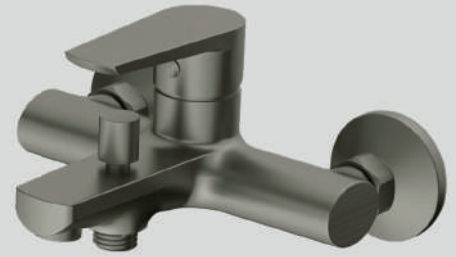

MIFONTE

GUN METAL

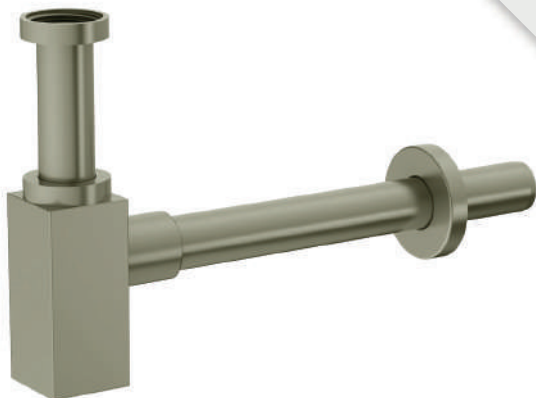

**VRHUNSKI DIZAJN
ODLIČNA KVALITETA
IZRAZITA FUNKCIONALNOST**

**OTPORNOST NA
OTISKE PRSTIJU**

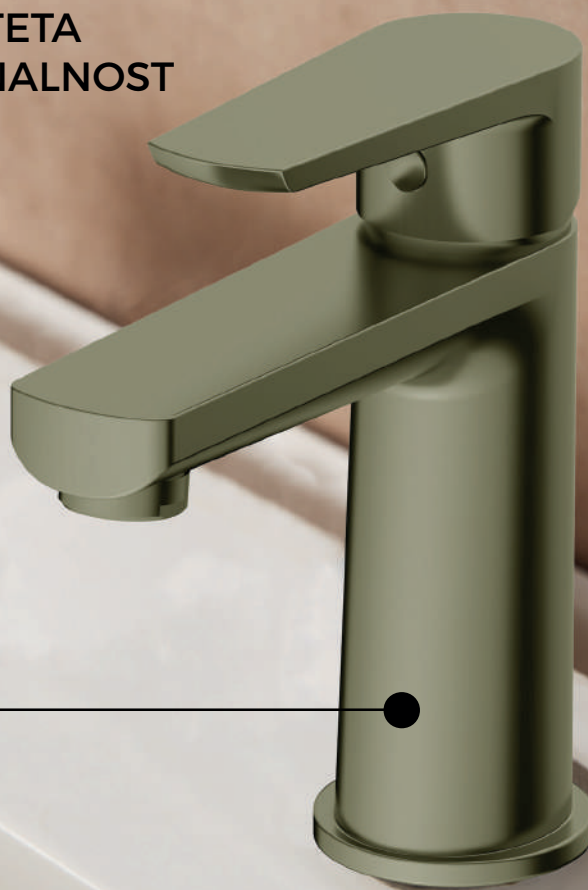

Kod završene obrade MIFONTE GUN METAL kolekcije je korištena PVD tehnologija (Physical Vapor Deposition). Ovaj vrhunski proces stvara molekularnu vezu sa slavinom što rezultira najtrajnijom završnom obradom koja je danas dostupna. Proizvodi s PVD završnom obradom neće korodirati, promijeniti boju ili potamniti.

Mifonte GUN METAL program posjeduje FINGER RESIST SLOJ koji sprječava ostavljanje otisaka prstiju



BATERIJA ZA UMIVAONIK

ŠIFRA VOKEL	BOJA	ŠIFRA ARTIKLA	PAKIRANJE
1189025	GUN METAL	1721H6142 GM	1



BATERIJA ZA UMIVAONIK VISOKA

ŠIFRA VOKEL	BOJA	ŠIFRA ARTIKLA	PAKIRANJE
1189026	GUN METAL	1721-1H6142 GM	1



BATERIJA ZA BIDE

ŠIFRA VOKEL	BOJA	ŠIFRA ARTIKLA	PAKIRANJE
1189027	GUN METAL	1722H6142 GM	1



BATERIJA ZA KADU

S CRIJEVOM I TUŠ RUČICOM

ŠIFRA VOKEL	BOJA	ŠIFRA ARTIKLA	PAKIRANJE
1189028	GUN METAL	1723H6142 GM	1

**RIO GRANDE TUŠ SUSTAV**

S CRIJEVOM, RUČICOM I TUŠ RUŽOM 25x25

ŠIFRA VOKEL	BOJA	ŠIFRA ARTIKLA	PAKIRANJE
1191081	GUN METAL	20B GM	1



TUŠ RUČICA - ČETVRTASTA

ŠIFRA VOKEL	BOJA	ŠIFRA ARTIKLA	PAKIRANJE
1191094	GUN METAL	HS30 GM	1



NADGLAVNI TUŠ

250 x 250

ŠIFRA VOKEL	BOJA	ŠIFRA ARTIKLA	PAKIRANJE
1191093	GUN METAL	RS07 GM	1



SIFON - ČETVRTASTI

ŠIFRA VOKEL	BOJA	ŠIFRA ARTIKLA	PAKIRANJE
1191091	GUN METAL	SF07 GM	1



CRIJEVO ZA TUŠ /PVC

1,5 m

ŠIFRA VOKEL	BOJA	ŠIFRA ARTIKLA	PAKIRANJE
1191098	GUN METAL	HS01 GM	1(BLISTER)



KUTNI VENTIL - ČETVRTASTI 1/2" - 3/8"

ŠIFRA VOKEL	BOJA	ŠIFRA ARTIKLA	PAKIRANJE
1191090	GUN METAL	YD53GM	1



PILETA KLIK-KLAK

5/4" BEZ RUPE ZA PRELJEV

ŠIFRA VOKEL	BOJA	ŠIFRA ARTIKLA	PAKIRANJE
1191089	GUN METAL	P23 GM	1



PILETA

5/4" BEZ RUPE ZA PRELJEV I BEZ KLIK-KLAKA

ŠIFRA VOKEL	BOJA	ŠIFRA ARTIKLA	PAKIRANJE
1191092	GUN METAL	P46 GM	1

VJEŠALICA



ŠIFRA VOKEL	BOJA	ŠIFRA ARTIKLA	PAKIRANJE
1715090	GUN METAL	8207AGM	1

DUPLA VJEŠALICA



ŠIFRA VOKEL	BOJA	ŠIFRA ARTIKLA	PAKIRANJE
1715091	GUN METAL	8207GM	1

DRŽAČ RUČNIKA 60 cm



ŠIFRA VOKEL	BOJA	ŠIFRA ARTIKLA	PAKIRANJE
1715092	GUN METAL	8203GM	1

DRŽAČ RUČNIKA 23 cm



ŠIFRA VOKEL	BOJA	ŠIFRA ARTIKLA	PAKIRANJE
1715093	GUN METAL	8206GM	1

DRŽAČ TOALET PAPIRA



ŠIFRA VOKEL	BOJA	ŠIFRA ARTIKLA	PAKIRANJE
1715094	GUN METAL	8205GM	1

WC ČETKA



ŠIFRA VOKEL	BOJA	ŠIFRA ARTIKLA	PAKIRANJE
1715095	GUN METAL	8208GM	1

DOZATOR SAPUNA S DRŽAČEM



ŠIFRA VOKEL	BOJA	ŠIFRA ARTIKLA	PAKIRANJE
1715097	GUN METAL	8211GM	1

DRŽAČ ČAŠE S ČAŠOM



ŠIFRA VOKEL	BOJA	ŠIFRA ARTIKLA	PAKIRANJE
1715096	GUN METAL	8210GM	1



KUTNI ETAŽER

NOTINO GUN METAL

ŠIFRA VOKEL	BOJA	ŠIFRA ARTIKLA	PAKIRANJE
1715098	GUN METAL	D1013GM	1



DUPLI KUTNI ETAŽER

NOTINO GUN METAL

ŠIFRA VOKEL	BOJA	ŠIFRA ARTIKLA	PAKIRANJE
1715099	GUN METAL	D1014GM	1



BATERIJA ZA UMIVAONIK

ŠIFRA VOKEL	BOJA	ŠIFRA ARTIKLA	PAKIRANJE
1742001	KROM	3381	1



BATERIJA ZA UMIVAONIK VISOKA

ŠIFRA VOKEL	BOJA	ŠIFRA ARTIKLA	PAKIRANJE
1742006	KROM	3381-1	1



BATERIJA ZA BIDE

ŠIFRA VOKEL	BOJA	ŠIFRA ARTIKLA	PAKIRANJE
1742002	KROM	3382	1



BATERIJA ZA TUŠ I KADU

S CRIJEVOM, RUČICOM I ZIDNIM DRŽAČEM TUŠA

ŠIFRA VOKEL	BOJA	ŠIFRA ARTIKLA	PAKIRANJE
1742003	KROM	3383	1



BATERIJA ZA TUŠ

S CRIJEVOM, RUČICOM I ZIDNIM DRŽAČEM TUŠA

ŠIFRA VOKEL	BOJA	ŠIFRA ARTIKLA	PAKIRANJE
1742004	KROM	3384	1



BATERIJA ZA KUHINJU

ŠIFRA VOKEL	BOJA	ŠIFRA ARTIKLA	PAKIRANJE
1742005	KROM	3385	1



JANA

ŠIFRA VOKEL	BOJA	ŠIFRA ARTIKLA	PAKIRANJE
1190016	KROM	3648	1



NORIN

ŠIFRA VOKEL	BOJA	ŠIFRA ARTIKLA	PAKIRANJE
1190017	KROM	0618-2	1



HIGIJENSKA BATERIJA

S VENTILOM, CRIJEVOM, RUČICOM

ŠIFRA VOKEL	BOJA	ŠIFRA ARTIKLA	PAKIRANJE
1191101	BRUSHED GOLD	1789	1



KONZOLA

ŠIFRA VOKEL	BOJA	ŠIFRA ARTIKLA	PAKIRANJE
1191066	BRUSHED GOLD	XS04016101G	1



KOZMETIČKO OGLEDALO

NOTINO CHROME - SAMOSTOJEĆE

ŠIFRA VOKEL	BOJA	ŠIFRA ARTIKLA	PAKIRANJE
1715110	KROM	4003CR	1



KOZMETIČKO OGLEDALO

NOTINO BLACK - SAMOSTOJEĆE

ŠIFRA VOKEL	BOJA	ŠIFRA ARTIKLA	PAKIRANJE
1715111	CRNA	4003B	1



KOZMETIČKO OGLEDALO

NOTINO GOLD - SAMOSTOJEĆE

ŠIFRA VOKEL	BOJA	ŠIFRA ARTIKLA	PAKIRANJE
1715112	GOLD	4003G	1

ALTA - kupaonski radijator



BOJA



BIJELA

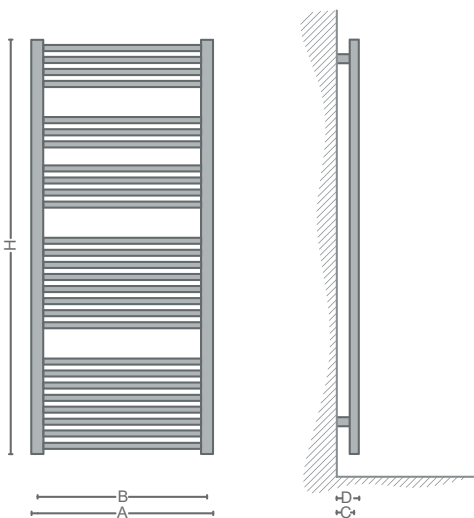
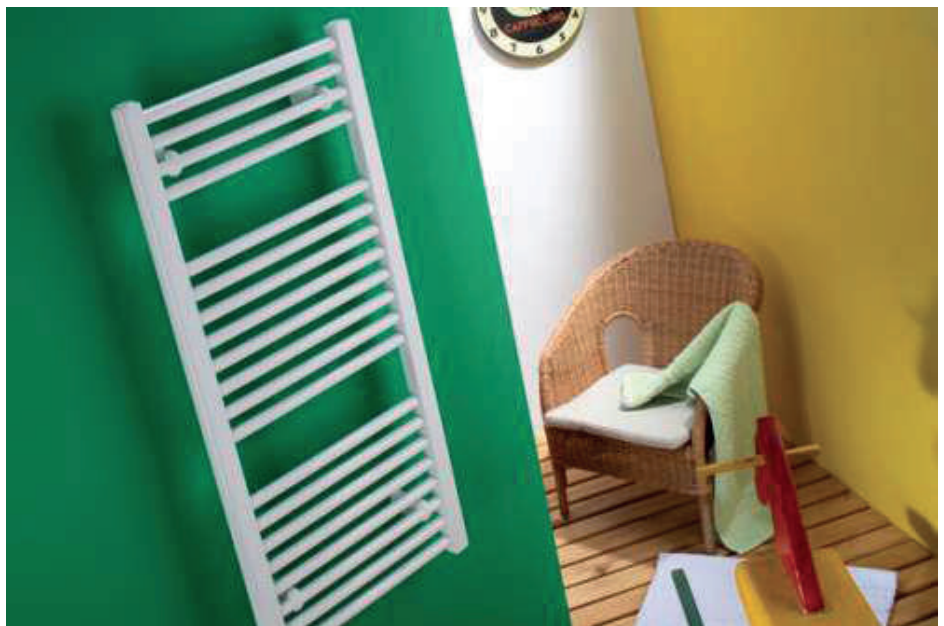

ŠIFRA VOKEL	A (mm)	H (mm)	B (mm)	C (mm)	D (mm)	m (kg)	P ₁ (Watt)	P ₂ (Watt)
0611041	450	974	400 / 50	70-90	85-105	7.47	388	400
0611042	450	1374	400 / 50	70-90	85-105	10.47	583	600
0611043	450	1694	400 / 50	70-90	85-105	13.07	718	800
0611044	600	974	550 / 50	70-90	85-105	9.34	521	600
0611045	600	1374	550 / 50	70-90	85-105	12.92	751	800
0611046	600	1694	550 / 50	70-90	85-105	15.66	916	800
	750	974	700 / 50	70-90	85-105	11.27	655	600
0611055	750	1374	700 / 50	70-90	85-105	15.77	919	800
	750	1694	700 / 50	70-90	85-105	19.07	1113	1000

BOJE PO NARUDŽBI

02	03	04
ANTRACIT	BEŽ	PLATINASTA

SORA - kupaonski radijator

BOJA

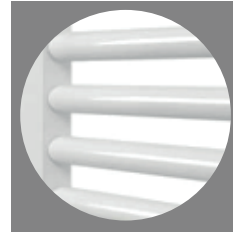

BIJELA

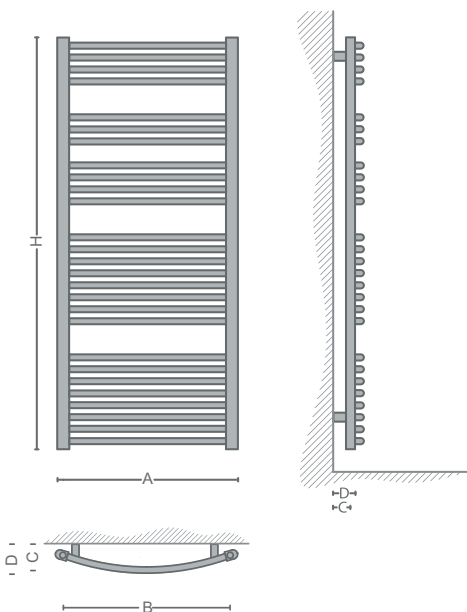

ŠIFRA VOKEL	A (mm)	H (mm)	B (mm)	C (mm)	D (mm)	m (kg)	P ₁ (Watt)	P ₂ (Watt)
0611047	450	974	395 / 50	60 / 95	105-125	7.47	388	400
0611048	450	1374	395 / 50	60 / 95	105-125	10.47	583	600
0611049	450	1694	395 / 50	60 / 95	105-125	13.07	718	800
0611050	600	974	545 / 50	60 / 100	115-135	9.34	521	600
0611051	600	1374	545 / 50	60 / 100	115-135	12.92	751	800
0611052	600	1694	545 / 50	60 / 100	115-135	15.66	916	800
	750	974	695 / 50	60 / 110	120-140	11.27	655	600
	750	1374	695 / 50	60 / 110	120-140	15.77	919	800
	750	1694	695 / 50	60 / 110	120-140	19.07	1113	1000

BOJE PO NARUDŽBI

02	03	04
ANTRACIT	BEŽ	PLATINASTA

"FIN"

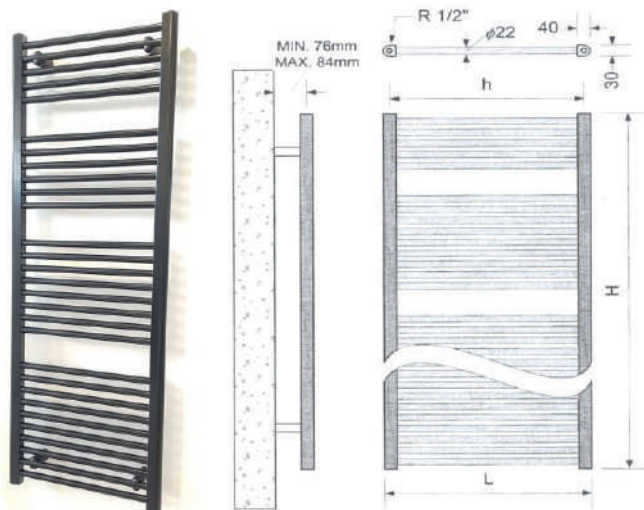

ŠIFRA VOKEL	NAZIV ARTIKLA	VISINA H (mm)	DUŽINA L (mm)	OSNI RAZMAK PRIKLJUČKA h (mm)	TOPLINSKI UČINAK Q(W) 90/70/20°C	SADRŽAJ VODE U RADIJATORU (Lit.)
39112	KUPAONSKI RADIJATOR FIN R01 BIJELI	770	500	460	555	3,65
39113	KUPAONSKI RADIJATOR FIN R02 BIJELI	770	600	560	645	4,16
39114	KUPAONSKI RADIJATOR FIN R04 BIJELI	980	500	460	678	4,47
39115	KUPAONSKI RADIJATOR FIN R05 BIJELI	980	600	560	784	5,06
39116	KUPAONSKI RADIJATOR FIN R07 BIJELI	1190	500	460	841	5,55
39117	KUPAONSKI RADIJATOR FIN R08 BIJELI	1190	600	560	915	6,30
39118	KUPAONSKI RADIJATOR FIN R10 BIJELI	1485	500	460	1029	6,79
39119	KUPAONSKI RADIJATOR FIN R11 BIJELI	1485	600	560	1192	7,71
39120	KUPAONSKI RADIJATOR FIN R13 BIJELI	1740	500	460	1225	8,10
39121	KUPAONSKI RADIJATOR FIN R14 BIJELI	1740	600	560	1422	9,19

1455001	KUPAONSKI RADIJATOR FIN R07 CRNI	1190	500	460	841	5,55
1455002	KUPAONSKI RADIJATOR FIN R08 CRNI	1190	600	560	915	6,30
1455003	KUPAONSKI RADIJATOR FIN R10 CRNI	1485	500	460	1029	6,79
1455004	KUPAONSKI RADIJATOR FIN R11 CRNI	1485	600	560	1192	7,71
1455005	KUPAONSKI RADIJATOR FIN R13 CRNI	1740	500	460	1225	8,10
1455006	KUPAONSKI RADIJATOR FIN R14 CRNI	1740	600	560	1422	9,19

MOA GRIJAČI

Zadivljujući minimalizam

MOA je grijač dizajniran s pažnjom na svaki detalj, prepoznatljiv po minimalističkom obliku i funkcionalnosti. Izuzetnu udobnost osigurava funkcija sušenja, zahvaljujući kojoj se može automatski promijeniti temperatura grijanja ili potpuno isključiti grijač. Veliki gumbi sa signaliziranjem trenutne i zadane temperature čine njegov rad intuitivnim. Grijač ima dvostupanjski sustav protiv pregrijavanja i kratkog spoja.

FUNKCIONALNOST

Grijač nudi pet temperaturnih nivoa u rasponu od 30°C do 60°C (moguće je promijeniti temperaturni raspon). Elektronski senzor u grijaču omogućuje njihovo precizno održavanje. Uređaj prikazuje trenutnu i podešenu temperaturu. Karakterizira ga vrlo niska potrošnja energije u stanju mirovanja.

Funkcija **SUŠENJA** omogućuje podešavanje bilo koje temperature u trajanju od dva sata nakon čega se grijač vraća u prethodno stanje.

INTELIGENTNI SUSTAVI ZGRADA

U slučaju nestanka struje, grijač pamti zadanu vrijednost (unaprijed postavljenu), omogućujući suradnju s vanjskim tajmerima i inteligentnim sustavima zgrada.

SIGURNOST

Grijač opremljen zaštitom od smrzavanja ANTIFREEZE koja sprječava pad temperature radijatora ispod 5-7 °C i dvostrukom zaštitom od prekomjernog porasta temperature radijatora. Signalizira stanje alarmom. Ima aktivnu zaštitu pri radu u suhom radijatoru.

- duljina kabela 2,5 m
- napajanje 230V / 50Hz



Š.Vokel	Opis
1416018	GRIJAČ MOA BIJELI 400W
1416019	GRIJAČ MOA BIJELI 600W
1416020	GRIJAČ MOA BIJELI 800W
1416021	GRIJAČ MOA BIJELI 1000W
1416022	GRIJAČ MOA BIJELI 1200W

Š.Vokel	Opis
1416023	GRIJAČ MOA KROM 400W
1416024	GRIJAČ MOA KROM 600W
1416025	GRIJAČ MOA KROM 800W
1416026	GRIJAČ MOA KROM 1000W
1416027	GRIJAČ MOA KROM 1200W

Š.Vokel	Opis
1416028	GRIJAČ MOA SIVI 400W
1416029	GRIJAČ MOA SIVI 600W
1416030	GRIJAČ MOA SIVI 800W
1416031	GRIJAČ MOA SIVI 1000W
1416032	GRIJAČ MOA SIVI 1200W

Gun Metal | Gold | Silver | Black



Dvostruki profil Bellavia tuš kabina pruža Premium kvalitetu, veću stabilnost i čvrstoću. Ravne linije profila prate estetske trendove i daju elegantan izgled. S kaljenim staklom koje je izuzetno otporno, pružamo kupcima sigurnost i udobnost.

U ponudi imamo tuš kabine, walk in stjenke, tuš vrata i paravane bijelih, silver, crnih, zlatnih i gun metal profila, u visinama od 185 do 200 cm, u kombinacijama prozirnog, zamagljenog mliječnog ili smokey stakla.



Vrata, stjenke i kabine posjeduju **svojstvo reverzibilnosti**, što znači da se po zahtjevima prostorije mogu okretati na lijevu ili na desnu stranu.



“EASY CLEANING GLASS- STAKLO S NANO PREMAZOM” poznato kao “staklo koje se samo čisti” odnosi se na staklenu površinu koja je presvučena posebnim premazom koji značajno sprječava zadržavanje prašine i kapljica vode što olakšava održavanje i čišćenje stakla.

**NANO
PREMAZ**

NOVO U PONUDI

Kompenzacijski profil - Ukoliko vam prostor za ugradnju tuš kabine nije standardnih dimenzija, u ponudi imamo i kompenzacijske profile koji nude produljenje do 2,58 CM po jednoj strani.

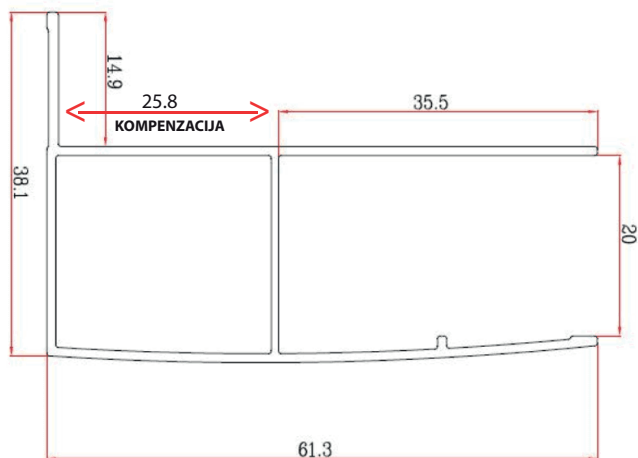

Instalacija: Postojeći profil se uklanja i mijenja kompenzacijskim.

ČETVRTASTA TUŠ KABINA 6Y1011-2-GM



GUN METAL PROFIL

H = 200

ŠIFRA VOKEL	DIMENZIJA	STAKLO	PROFIL	UGRADNA MJERA (cm)
1113319	90x90	PROZIRNO STAKLO 6mm	GUN METAL PROFIL	88-90

REZERVNI DIJELOVI

H = 200

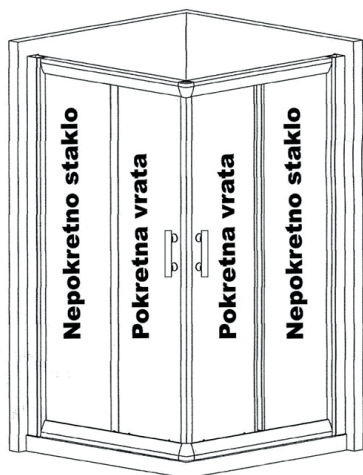

POKRETNNA VRATA

ŠIFRA VOKEL	STAKLO	ZA DIMENZIJU
1113262	PROZIRNO STAKLO	90x90

NEPOKRETNNO STAKLO

ŠIFRA VOKEL	STAKLO	ZA DIMENZIJU
1113263	PROZIRNO STAKLO	90x90

ŠIFRA VOKEL	OPIS	PAK/KOM
1113270	DIHTUNG S MAGNETOM ZA POKRETNNA VRATA	SET (2)
1113275	DIHTUNG IZMEĐU POKRETNIIH I NEPOKRETNIIH VRATA	SET (2)

	ŠIFRA VOKEL
TOČKIĆI - GORNJI	1113346
TOČKIĆI - DONJI	1113347

RUČKICA

	ŠIFRA VOKEL
S DVIJE RUPE	1113348

ČETVRTASTA TUŠ KABINA 6Y1013CGM



GUN METAL PROFIL

H = 200

ŠIFRA VOKEL	DIMENZIJA	STAKLO	PROFIL	UGRADNA MJERA (cm)
1113320	80x120	SMOKEY STAKLO 6 mm	GUN METAL	78-80/118-120
1113321	90x120	SMOKEY STAKLO 6 mm	PROFIL	88-90/118-120

REZERVNI DIJELOVI

H = 200

POKRETNNA VRATA

ŠIFRA VOKEL	STAKLO	ZA DIMENZIJU
1113396	SMOKEY STAKLO	80x120
1113397	SMOKEY STAKLO	90x120

NEPOKRETNNO STAKLO

ŠIFRA VOKEL	STAKLO	ZA DIMENZIJU
1113398	SMOKEY STAKLO	80x120
1113399	SMOKEY STAKLO	90x120

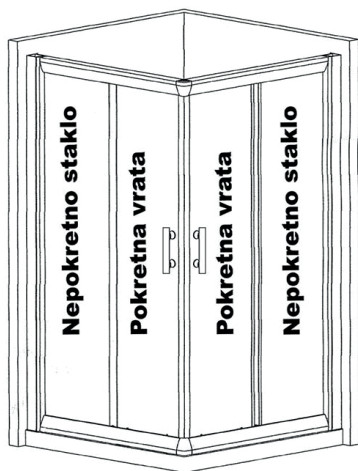

ŠIFRA VOKEL	OPIS	PAK/KOM
1113270	DIHTUNG S MAGNETOM ZA POKRETNNA VRATA	SET (2)
1113275	DIHTUNG IZMEĐU POKRETNIIH I NEPOKRETNIIH VRATA	SET (2)

	ŠIFRA VOKEL
TOČKIĆI - GORNJI	1113346
TOČKIĆI - DONJI	1113347

RUČKICA

	ŠIFRA VOKEL
S DVIJE RUPE	1113348

TUŠ VRATA 6740-2-GM



GUN METAL PROFIL

H = 200

ŠIFRA VOKEL	L	H	OPIS	PROFIL	UGRADNA MJERA (cm)
1113318	120	200	TUŠ VRATA PROZIRNO STAKLO	GUN METAL PROFIL	118-120

REZERVNI DIJELOVI

ŠIFRA VOKEL	OPIS
1113349	VRATA PROZIRNO STAKLO

	ŠIFRA VOKEL
TOČKIĆI - GORNJI	1113367
TOČKIĆI - DONJI	1113368

TUŠ STJENKA WALK IN



GUN METAL PROFIL

H = 200



TUŠ STJENKA 8W1002GM

ŠIFRA VOKEL	L	H	D	OPIS	PROFIL	UGRADNA MJERA (cm)
1113322	80	200	80-120	PROZIRNO STAKLO 8 mm	GUN METAL PROFIL	78,5-80
1113323	90			PROZIRNO STAKLO 8 mm		88,5-90
1113324	100			PROZIRNO STAKLO 8 mm		98,5-100
1113325	110			PROZIRNO STAKLO 8 mm		108,5-110
1113326	120			PROZIRNO STAKLO 8 mm		118,5-120

REZERVNI DIJELOVI

ŠIFRA VOKEL	OPIS
1113350	STABILIZATOR ZA WALK IN 8W1002-056 - GUN METAL, 80-120

TUŠ VRATA VENERA SILVER 6Y1150



SILVER PROFIL

H = 200

ŠIFRA VOKEL	L	H	OPIS	PROFIL	UGRADNA MJERA (cm)
1113327	120	200	PROZIRNO STAKLO 6 mm	SILVER PROFIL	117-120
1113328	140		PROZIRNO STAKLO 6 mm		137-140
1113329	160		PROZIRNO STAKLO 6 mm		157-160

TUŠ STJENKA VENERA 6D1042



SILVER PROFIL

H = 200

ZA VRATA 6Y1150

ŠIFRA VOKEL	L	H	OPIS	PROFIL	UGRADNA MJERA (cm)
1113333	80	200	PROZIRNO STAKLO 6 mm	SILVER PROFIL	78,5-80
1113334	90		PROZIRNO STAKLO 6 mm		88,5-90
1113335	100		PROZIRNO STAKLO 6 mm		98,5-100

REZERVNI DIJELOVI

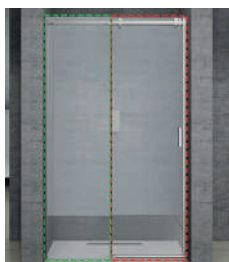

POKRETNIA VRATA

ŠIFRA VOKEL	OPIS	ZA DIMENZIJU
1113361	PROZIRNO STAKLO S NANO PREMAZOM	120
1113362		140
1113363		160

NEPOKRETNIA STAKLO

ŠIFRA VOKEL	OPIS	ZA DIMENZIJU
1113364	PROZIRNO STAKLO S NANO PREMAZOM	120
1113365		140
1113366		160

REZERVNI DIJELOVI ZA VENERU

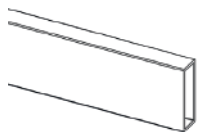

VODILICA

ŠIFRA VOKEL	ZA DIMENZIJU	OPIS
1113353	120	VODILICA ZA VENERU KROM
1113390	140	
1113391	160	



DONJI DIHTUNG

ŠIFRA VOKEL	ZA DIMENZIJU	OPIS
1113355	120	DONJI DIHTUNG NA VRATIMA
1113392	140	
1113393	160	



ZAŠTITNA LAJSNA

ŠIFRA VOKEL	ZA DIMENZIJU	OPIS
1113381	120	ZAŠTITNA LAJSNA
1113394	140	
1113395	160	



DIHTUNG

ŠIFRA VOKEL	OPIS
1113356	DIHTUNG IZMEĐU POKRETNIH I NEPOKRETNIH VRATA



LEŽAJ

ŠIFRA VOKEL	OPIS
1113357	LEŽAJ ZA TUŠ VRATA



NOSAČ

ŠIFRA VOKEL	OPIS
1113373	NOSAČ KLIZNE ŠIPKE



MAGNET

ŠIFRA VOKEL	OPIS
1113375	MAGNET NA VRATIMA



MAGNET

ŠIFRA VOKEL	OPIS
1113377	MAGNET U PROFILU

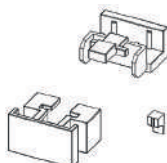

DRŽAČ

ŠIFRA VOKEL	OPIS
1113379	DRŽAČ LAJSNE

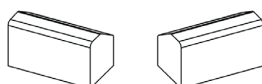

DRŽAČ

ŠIFRA VOKEL	OPIS
1113383	DRŽAČ STAKLA

TUŠ VRATA 6K1015A



SILVER PROFIL

H = 200

TUŠ VRATA 6K1015A

ŠIFRA VOKEL	L	H	OPIS	PROFIL	UGRADNA MJERA (cm)
1113300	80	200	OTVARANJE PREMA VAN, PROZIRNO STAKLO 6 mm	SILVER PROFIL	76-78
1113301	90		OTVARANJE PREMA VAN, PROZIRNO STAKLO 6 mm		86-88
1113302	100		OTVARANJE PREMA VAN, PROZIRNO STAKLO 6 mm		96-98

TUŠ VRATA 6K1015A



CRNI PROFIL

H = 200

TUŠ VRATA 6K1015A

ŠIFRA VOKEL	L	H	OPIS	PROFIL	UGRADNA MJERA (cm)
1113297	80	200	OTVARANJE PREMA VAN, PROZIRNO STAKLO 6 mm	CRNI PROFIL	76-78
1113298	90		OTVARANJE PREMA VAN, PROZIRNO STAKLO 6 mm		86-88
1113299	100		OTVARANJE PREMA VAN, PROZIRNO STAKLO 6 mm		96-98

TUŠ VRATA VENERA BLACK 6Y1150B



BLACK PROFIL

H = 200

ŠIFRA VOKEL	L	H	OPIS	PROFIL	UGRADNA MJERA (cm)
1113330	120	200	PROZIRNO STAKLO 6 mm	BLACK PROFIL	117-120
1113331	140		PROZIRNO STAKLO 6 mm		137-140
1113332	160		PROZIRNO STAKLO 6 mm		157-160

TUŠ STJENKA VENERA 6D1042B



BLACK PROFIL

H = 200

ZA VRATA 6Y1150B

ŠIFRA VOKEL	L	H	OPIS	PROFIL	UGRADNA MJERA (cm)
1113336	80	200	PROZIRNO STAKLO 6 mm	BLACK PROFIL	78,5-80
1113337	90		PROZIRNO STAKLO 6 mm		88,5-90
1113338	100		PROZIRNO STAKLO 6 mm		98,5-100

REZERVNI DIJELOVI

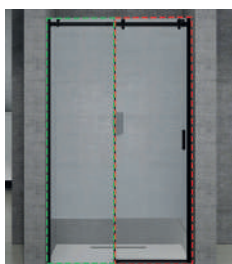

POKRETNNA VRATA

ŠIFRA VOKEL	OPIS	ZA DIMENZIJU
1113361	PROZIRNO STAKLO S NANO PREMAZOM	120
1113362		140
1113363		160

NEPOKRETNNO STAKLO

ŠIFRA VOKEL	OPIS	ZA DIMENZIJU
1113364	PROZIRNO STAKLO S NANO PREMAZOM	120
1113365		140
1113366		160

REZERVNI DIJELOVI ZA VENERA BLACK

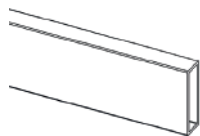

VODILICA

ŠIFRA VOKEL	ZA DIMENZIJU	OPIS
1113354	120	VODILICA ZA VENERU BLACK
1113384	140	
1113385	160	



DONJI DIHTUNG

ŠIFRA VOKEL	ZA DIMENZIJU	OPIS
1113360	120	DONJI DIHTUNG NA VRATIMA VENERA BLACK
1113386	140	
1113387	160	



ZAŠTITNA LAJSNA

ŠIFRA VOKEL	ZA DIMENZIJU	OPIS
1113380	120	ZAŠTITNA LAJSNA BLACK
1113388	140	
1113389	160	

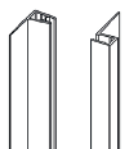

DIHTUNG

ŠIFRA VOKEL	OPIS
1113359	DIHTUNG IZMEĐU POKRETNIH I NEPOKRETNIH VRATA VENERA BLACK



LEŽAJ

ŠIFRA VOKEL	OPIS
1113358	LEŽAJ ZA TUŠ VRATA VENERA BLACK



NOSAČ

ŠIFRA VOKEL	OPIS
1113372	NOSAČ KLIZNE ŠIPKE BLACK



MAGNET

ŠIFRA VOKEL	OPIS
1113374	MAGNET NA VRATIMA BLACK



MAGNET

ŠIFRA VOKEL	OPIS
1113376	MAGNET U PROFILU BLACK

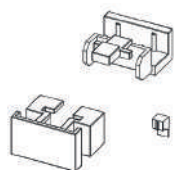

DRŽAČ

ŠIFRA VOKEL	OPIS
1113378	DRŽAČ LAJSNE BLACK

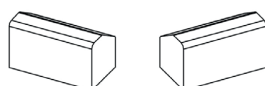

DRŽAČ

ŠIFRA VOKEL	OPIS
1113382	DRŽAČ STAKLA L/D BLACK

Tuš kada BELLA



Bijela akrilna tuš kada sa oblogom izrađena od 100% lijevanog sanitarnog akrila (PMMA), podnožje kade ojačano drvenom pločom te poliesterskom smolom i staklenim platnom.

Garancija kvalitete i trajnosti 10 godina.

Šifra Vokel	Opis	ART.
1181001	TUŠ KADA 90x90 BELLA S OBLOGOM, POLUKRUŽNA	00733
1181002	TUŠ KADA 80x80 BELLA S OBLOGOM, POLUKRUŽNA	00734

Dužina : 0.8 m - 0.9 m

Širina : 0.8 m - 0.9 m

Visina : 0.195 m

Dubina : 0.08 m

Oblik : kutna polukružna

Tuš kada QUADRO



Bijela akrilna tuš kada sa oblogom izrađena od 100% lijevanog sanitarnog akrila (PMMA), podnožje kade ojačano drvenom pločom te poliesterskom smolom i staklenim platnom.

Garancija kvalitete i trajnosti 10 godina.

Šifra Vokel	Opis	ART.
1181003	TUŠ KADA 90x90 QUADRO S OBLOGOM, ČETVRTASTA	00729
1181004	TUŠ KADA 80x80 BELLA S OBLOGOM, ČETVRTASTA	00730

Dužina : 0.8 m - 0.9 m

Širina : 0.8 m - 0.9 m

Visina : 0.195 m

Dubina : 0.07 m

Oblik : kvadratna

PERFECT WATER PRESSURE

FINALLY COMPACT AND EASY TO INSTALL



Š.Vokel	Opis
0633059	UREĐAJ ZA POVIŠENJE TLAKA SCALA2 3-45 ART.98562862

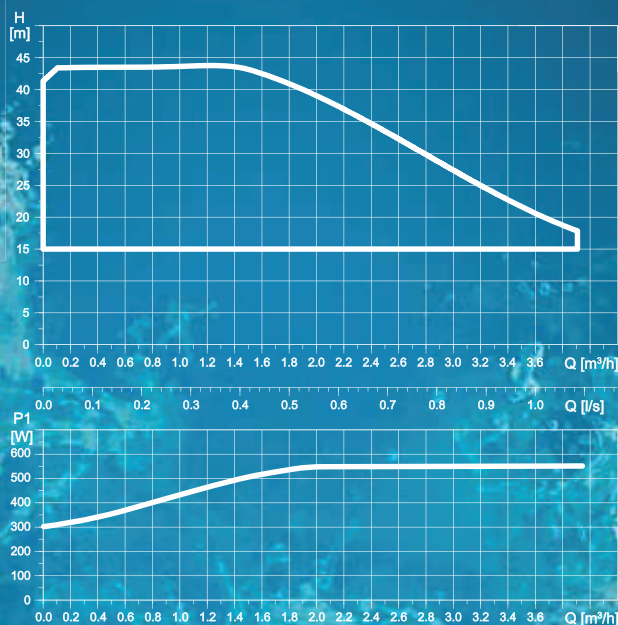

Idealan tlak u kućanstvu uz SCALA2 – jednostavna i lagana za montažu

SCALA2 je mala crpka za kućanstvo koja osigurava idealan tlak u svim slavinama - čak i kada je istovremeno otvoreno nekoliko slavina i tuš. Sastoji se od crpke, motora, spremnika i nepovratnog ventila i sve to u jednoj maloj kompaktnoj jedinici koja se lako i brzo montira. Pametna crpka SCALA2 prilagođava svoj rad svim zahtjevima uz najnižu razinu buke u svojoj klasi.

Što je to inteligentni nadzor crpke?

SCALA2 ima ugrađen senzor koji konstantno mjeri izlazni tlak. Ukoliko tlak padne ispod određene razine, SCALA2 pojačava djelovanje odmah, kako bi nadoknadila gubitak tlaka u sustavu. Mi to nazivamo inteligentni nadzor rada crpke i rezultat toga je idealan tlak vode u domaćinstvu.

Prednosti

- Idealan tlak : Inteligentni nadzor rada crpke prilagođava rad i tako osigurava idealan tlak tijekom cijelog vremena
- Niska buka: S razinom buke od samo (47 dB(A)) SCALA2 je najtiši uređaj u svojoj klasi
- Jednostavan odabir: Jedna varijanta za sve primjene u kućanstvima
- Lagana montaža: Kompaktno i sve u jednom rješenje za savršenu montažu u svim prilikama.
- Jednostavno rukovanje: Prijateljsko sučelje uz jednostavne postavke
- Pouzdan rad: Zaštita od rada na suho, zaštita od učestalog uključivanja
- Dugi vijek trajanja: Kvaliteta testirana do savršenstva, niski troškovi održavanja

Primjene

SCALA2 je namijenjena svim objektima visine do 3 kata i do ukupno 8 slavina.

- Gradski vodovod: Povišenje tlaka vode iz mreže gradskog vodovoda
- Spremnici: Povišenje tlaka vode iz krovnih spremnika, podzemnih spremnika, uključujući i spremnike kišnice.
- Bunari: Crpljenje vode iz bunara do dubine 8 metara

ALPHA1 L

UNIVERZALNA CIRKULACIONA CRPKA

ALPHA1 L odgovara većini postojećih instalacija gdje su već bile ugrađene Grundfos crpke, zahvaljujući kompaktnom dizajnu, priključcima za signalne kablove (PWM) i boljem podnošenju visokih temperatura. To znači da se lako može zamjeniti pokvarena ili ne učinkovita crpka bez dodatnog ulaganja vremena i novca.



Prednosti:

- Kompatibilna je s većinom postojećih instalacija s Grundfos crpkama
- Manja potreba za rezervnim dijelovima
- Mijenja kompletnu crpku ili samo glavu crpke
- Priključak za signalne kablove (PWM)
- Izdržljiva konstrukcija i visokokvalitetni materijali

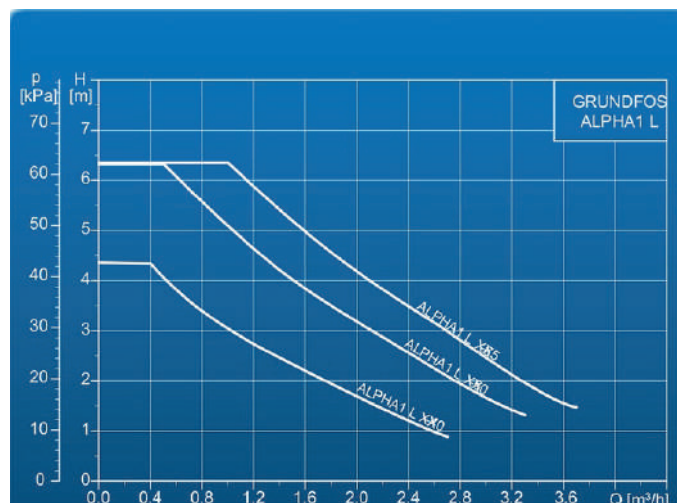

Tehničke karakteristike:

Klasa izolacije:	IP42
Razina buke:	43 dB (A)
Temperaturni razred:	TF110
Potrošnja energije:	4-60 W
Volumen protoka, Q :	3,8 m ³ /h
Visina dizanja, H _{max} :	6,5 m
EEL (razred energetske učinkovitosti)	< 0,23
Temperatura tekućine:	+2°C... + 110°C
Temperatura okoline:	0°C... +55°C

Prednosti:

- Tri konstantne krivulje / konstantne brzine
- Prikladna za radijatorsko grijanje
- Prikladna za podno grijanje
- PWM priključak za signalne kablove
- Vijak za deblokadu
- Niski index energetske učinkovitosti (EEL)
- Niski troškovi održavanja
- Niska razina buke
- Vrlo jednostavna montaža

ŠIFRA VOKEL	OPIS	ŠIFRA ARTIKLA
0633060	CIRKULACIONA PUMPA ALPHA1 L 25-40	99160579
0633061	CIRKULACIONA PUMPA ALPHA1 L 25-60	99160584
0633062	CIRKULACIONA PUMPA ALPHA1 L 32-60	99160590

CIRKULACIONE PUMPE IMP SAN

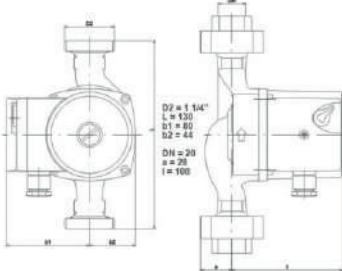
 	<p>0695012</p>	<p>CIRKULACIONA PUMPA IMP SAN 20/40</p>	<p>ART.979521766</p>
	<p>0695021</p>	<p>CIRKULACIONA PUMPA IMP SAN 20/60</p>	<p>ART.979521769</p>
	<p>0695023</p>	<p>CIRKULACIONA PUMPA IMP SAN 20/70</p>	<p>ART.979522018</p>

 kratki

 Vokel

PATIO

PLINSKA GRIJALICA ZA TERASE
CRNA BOJA



ŠIFRA VOKEL

OPIS

1446035

**TERASNA PLINSKA GRIJALICA CRNE BOJE 8,2 kW
art.PATIO/M/G30/30MBAR/CZ**

PATIO

PLINSKA GRIJALICA ZA TERASE
BIJELA BOJA

kratki

Vokel



ŠIFRA VOKEL

OPIS

1446036

TERASNA PLINSKA GRIJALICA BIJELE BOJE 8,2 kW
art.PATIO/M/G30/30MBAR/B

WIKTOR/PF

UGRADNI GUSANI KAMIN NA DRVA



≥ 900 cm²
≥ 700 cm²

- snaga - 14
- težina - 124
- promjer - Ø 200
- dužina drveta - 450 mm
- učinkovitost - 70%
- raspon snage - 7-18
- temperatura plinova - 352

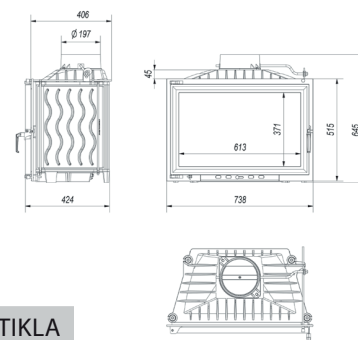

ŠIFRA VOKEL	BOJA	SNAGA	ŠIFRA ARTIKLA
1446001	CRNA	14 kW	WIKTOR/PF

ZUZIA/L/BS

UGRADNI GUSANI KAMIN NA DRVA - LIJEVO BOČNO STAKLO



≥ 1000 cm²
≥ 800 cm²

- snaga - 16
- težina - 183
- promjer - Ø 200
- dužina drveta - 500 mm
- učinkovitost - 76%
- raspon snage - 7,5-21
- temperatura plinova - 355

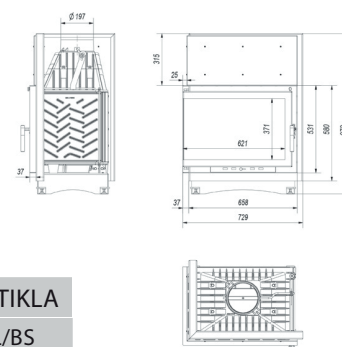

ŠIFRA VOKEL	BOJA	SNAGA	ŠIFRA ARTIKLA
1446002	CRNA	16 kW	ZUZIA/L/BS

ZUZIA/P/BS

UGRADNI GUSANI KAMIN NA DRVA - DESNO BOČNO STAKLO



≥ 1000 cm²
≥ 800 cm²

- snaga - 16
- težina - 183
- promjer - Ø 200
- dužina drveta - 500 mm
- učinkovitost - 76%
- raspon snage - 7,5-21
- temperatura plinova - 355

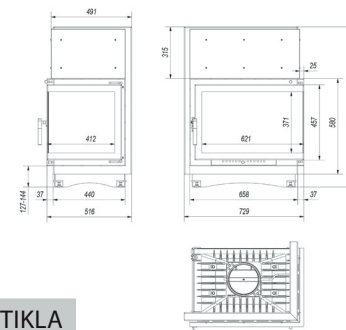

ŠIFRA VOKEL	BOJA	SNAGA	ŠIFRA ARTIKLA
1446003	CRNA	16 kW	ZUZIA/P/BS

OLIWIA/G

UGRADNI GUSANI KAMIN NA DRVA



≥ 1000 cm²
≥ 800 cm²

- snaga - 18
- težina - 244
- promjer - Ø 200
- dužina drveta - 500 mm
- učinkovitost - 79%
- raspon snage - 9-23
- temperatura plinova - 383

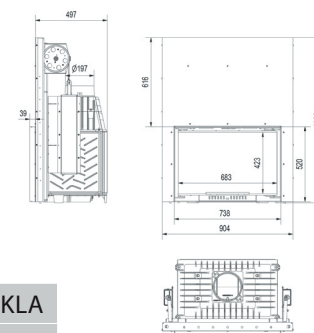







ŠIFRA VOKEL	BOJA	SNAGA	ŠIFRA ARTIKLA
1446034	CRNA	18 kW	OLIWIA/G

KASETA/ARKE/80

UGRADNI ČELIČNI KAMIN NA DRVA S INTEGRIRANIM VENTILATOROM

 ≥ 900 cm²
 ≥ 700 cm²

-  snaga - 12
-  težina - 132
-  promjer - Ø 200
-  dužina drveta - 350 mm
-  učinkovitost - 75%
-  raspon snage - 6-16
-  temperatura plinova - 320

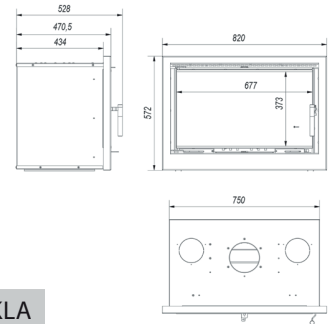







ŠIFRA VOKEL	BOJA	SNAGA	ŠIFRA ARTIKLA
1446004	CRNA	12 kW	KASETA/ARKE/80

MAJA/L/BS/DECO

UGRADNI GUSANI KAMIN NA DRVA - LIJEVO BOČNO STAKLO

 ≥ 700 cm²
 ≥ 500 cm²

-  snaga - 8
-  težina - 139
-  promjer - Ø 200
-  dužina drveta - 330 mm
-  učinkovitost - 80%
-  raspon snage - 3-10
-  temperatura plinova - 238

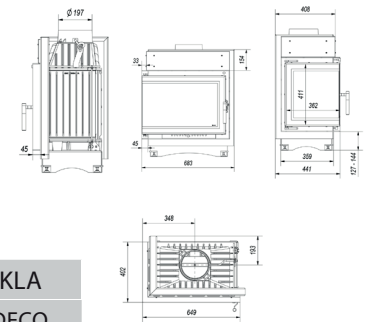







ŠIFRA VOKEL	BOJA	SNAGA	ŠIFRA ARTIKLA
1446039	CRNA	8 kW	MAJA/L/BS/DECO

MAJA/P/BS/DECO

UGRADNI GUSANI KAMIN NA DRVA - DESNO BOČNO STAKLO

 ≥ 700 cm²
 ≥ 500 cm²

-  snaga - 8
-  težina - 139
-  promjer - Ø 200
-  dužina drveta - 330 mm
-  učinkovitost - 80%
-  raspon snage - 3-10
-  temperatura plinova - 238

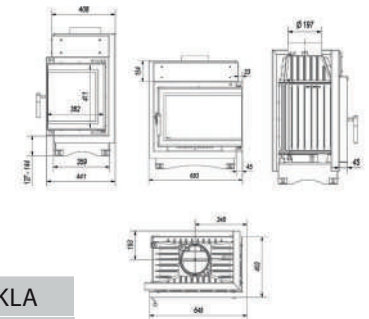







ŠIFRA VOKEL	BOJA	SNAGA	ŠIFRA ARTIKLA
1446040	CRNA	8 kW	MAJA/P/BS/DECO

NBC/800/400

UGRADNI ČELIČNI KAMIN NA DRVA

 ≥ 700 cm²
 ≥ 500 cm²

-  snaga - 10
-  težina - 275
-  promjer - Ø 200
-  dužina drveta - 300 mm
-  učinkovitost - 83%
-  raspon snage - 5-13
-  temperatura plinova - 191

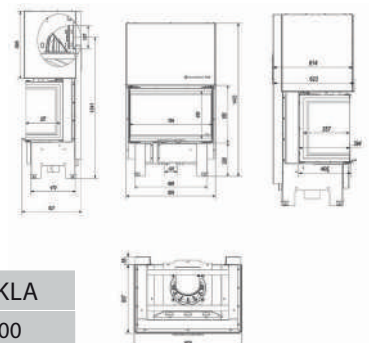

ŠIFRA VOKEL	BOJA	SNAGA	ŠIFRA ARTIKLA
1446043	CRNA	10 kW	NBC/800/400

MB120/G

UGRADNI KAMIN NA DRVA



≥ 1000 cm²
≥ 800 cm²

- snaga - 20
- težina - 396
- promjer - Ø 200
- dužina drveta - 500 mm
- učinkovitost - 80%
- raspon snage - 10-27
- temperatura plinova - 240

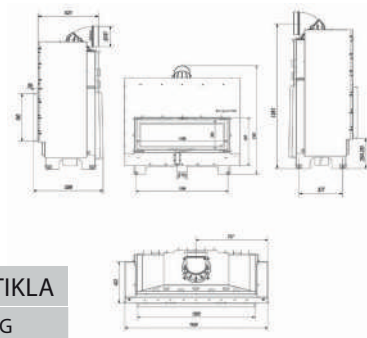

ŠIFRA VOKEL	BOJA	SNAGA	ŠIFRA ARTIKLA
1446044	CRNA	20 kW	MB120/G

KAMIN WK 440

KALIJEVA PEĆ NA DRVA



- snaga - 6,5
- težina - 130
- promjer - Ø 130
- dužina drveta - 350 mm
- učinkovitost - 80%
- raspon snage - 3-9,3
- temperatura plinova - 327

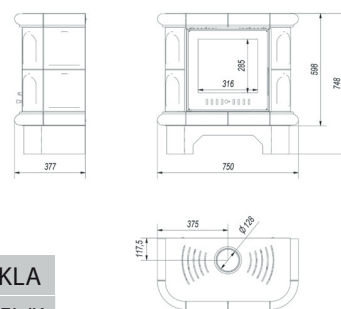

ŠIFRA VOKEL	BOJA	SNAGA	ŠIFRA ARTIKLA
1446006	BIJELA	6,5 kW	WK/440/KAFEL/K

KAMIN KOZA/AB/S/N/DR/KAF/CZER

KAMIN NA DRVA



- snaga - 8
- težina - 106
- promjer - Ø 150
- dužina drveta - 250 mm
- učinkovitost - 78%
- raspon snage - 5,5-10,5
- temperatura plinova - 265

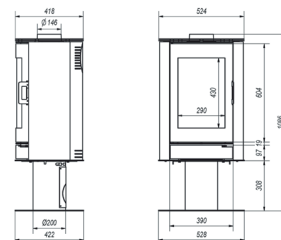

ŠIFRA VOKEL	BOJA	SNAGA	ŠIFRA ARTIKLA
1446042	CRVENA	8 kW	KOZA/AB/S/N/KAFEL/ CZERWONY



KAMIN/KOZA/AB/S/DR

KAMIN NA DRVA



- snaga - 8
- težina - 110
- promjer - Ø 150
- dužina drveta - 250 mm
- učinkovitost - 78%
- raspon snage - 5,5-10,5
- temperatura plinova - 265

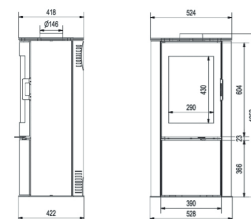

ŠIFRA VOKEL	BOJA	SNAGA	ŠIFRA ARTIKLA
1446021	CRVENA	8 kW	KOZA/AB/S/DR/KAFEL/ CZERWONY



KAMIN KOZA/AB/S/DR

KAMIN NA DRVA



- snaga - 8
- težina - 110
- promjer - Ø 150
- dužina drveta - 250 mm
- učinkovitost - 78%
- raspon snage - 5,5-10,5
- temperatura plinova - 265

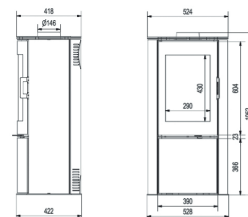

ŠIFRA VOKEL	BOJA	SNAGA	ŠIFRA ARTIKLA
1446011	CRNA	8 kW	KOZA/AB/S/DR/KAFEL/CZARNY

KAMIN/KOZA/AB/S/N/DR/KAF/CZARNY

KAMIN NA DRVA



- snaga - 8
- težina - 110
- promjer - Ø 150
- dužina drveta - 250 mm
- učinkovitost - 78%
- raspon snage - 5,5-10,5
- temperatura plinova - 265



ŠIFRA VOKEL	BOJA	SNAGA	ŠIFRA ARTIKLA
1446042	CRNA	8 kW	KOZA/AB/S/N/DR/KAFEL/CZARNY

KAMIN KOZA/K5/S/W

KAMIN NA DRVA



- snaga - 7
- težina - 1225
- promjer - Ø 150
- dužina drveta - 250 mm
- učinkovitost - 76%
- raspon snage - 5,5-9
- temperatura plinova - 250

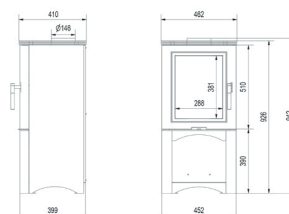

ŠIFRA VOKEL	BOJA	SNAGA	ŠIFRA ARTIKLA
1446012	CRNA	7 kW	KOZA/K5/S/W

KAMIN KOZA/K7

GUSANI KAMIN NA DRVA



- snaga - 5
- težina - 75
- promjer - Ø 130
- dužina drveta - 300 mm
- učinkovitost - 71%
- raspon snage - 3-8
- temperatura plinova - 340

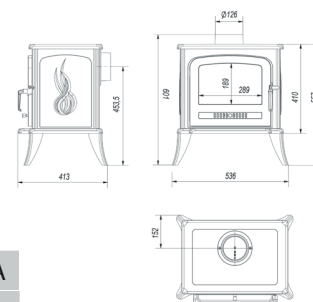

ŠIFRA VOKEL	BOJA	SNAGA	ŠIFRA ARTIKLA
1446008	CRNA	5 kW	KOZA/K7

KAMIN KOZA/K8
GUSANI KAMIN NA DRVA



- snaga - 9
- težina - 127
- promjer - Ø 130
- dužina drveta - 350 mm
- učinkovitost - 75%
- raspon snage - 5-11
- temperatura plinova - 385

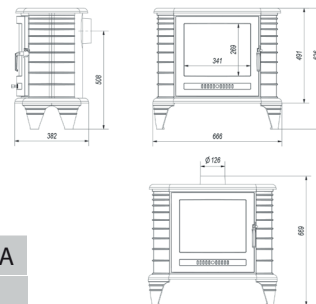

ŠIFRA VOKEL	BOJA	SNAGA	ŠIFRA ARTIKLA
1446009	CRNA	9 kW	KOZA/K8

KAMIN KOZA/K10
GUSANI KAMIN NA DRVA



- snaga - 10
- težina - 109
- promjer - Ø 130
- dužina drveta - 350 mm
- učinkovitost - 75%
- raspon snage - 6-13
- temperatura plinova - 334

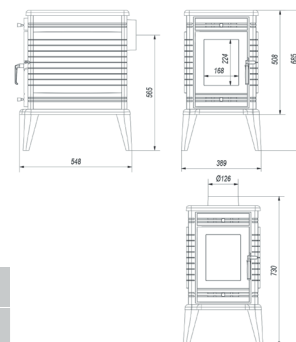

ŠIFRA VOKEL	BOJA	SNAGA	ŠIFRA ARTIKLA
1446010	CRNA	10 kW	KOZA/K10

THOR/VIEW8
KAMIN NA DRVA



- snaga - 8
- težina - 140
- promjer - Ø 150
- raspon snage - 5,5-10
- učinkovitost - 83%
- temperatura plinova - 175

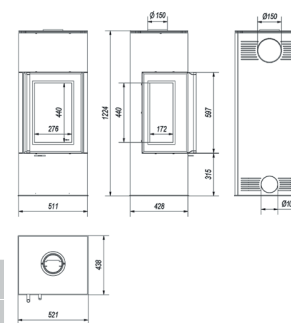

ŠIFRA VOKEL	BOJA	SNAGA	ŠIFRA ARTIKLA
1446037	CRNA	8 kW	THORE/VIEW8

THOR8
KAMIN NA DRVA



- snaga - 8
- težina - 160
- promjer - Ø 150
- raspon snage - 5,5-10
- učinkovitost - 83%
- temperatura plinova - 175

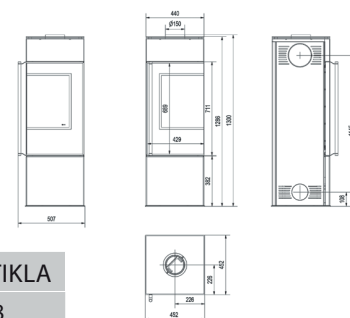

ŠIFRA VOKEL	BOJA	SNAGA	ŠIFRA ARTIKLA
1446038	CRNA	8 kW	THOR8

ZUZIA/G

UGRADNI KAMIN NA DRVA



- snaga - 16
- težina - 225
- promjer - Ø 200
- dužina drveta - 500 mm
- učinkovitost - 76%
- raspon snage - 7,5 - 21
- temperatura plinova - 355

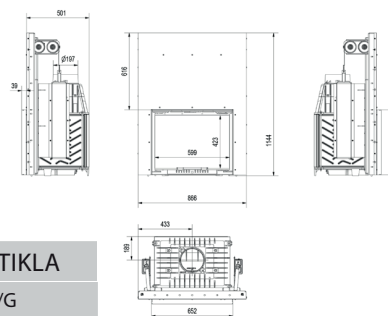

ŠIFRA VOKEL	BOJA	SNAGA	ŠIFRA ARTIKLA
1446071	CRNA	16 kW	ZUZIA/G

ZUZIA/P/BS/G

UGRADNI KAMIN NA DRVA



- snaga - 16
- težina - 243
- promjer - Ø 200
- dužina drveta - 500 mm
- učinkovitost - 76%
- raspon snage - 7,5 - 21
- temperatura plinova - 355

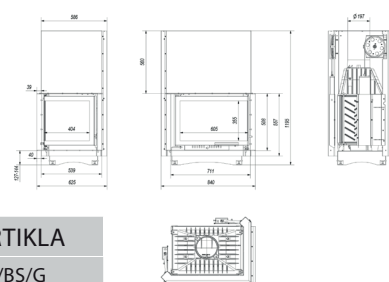

ŠIFRA VOKEL	BOJA	SNAGA	ŠIFRA ARTIKLA
1446072	CRNA	16 kW	ZUZIA/P/BS/G

ZUZIA/L/BS/G

UGRADNI KAMIN NA DRVA



- snaga - 16
- težina - 243
- promjer - Ø 200
- dužina drveta - 500 mm
- učinkovitost - 76%
- raspon snage - 7,5 - 21
- temperatura plinova - 355

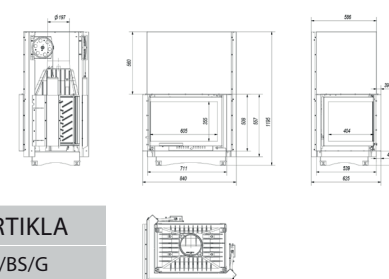

ŠIFRA VOKEL	BOJA	SNAGA	ŠIFRA ARTIKLA
1446073	CRNA	16 kW	ZUZIA/L/BS/G

MILA/PW/24/G/W

UGRADNI ČELIČI KAMIN NA DRVA ZA CENTRALNO GRIJANJE



≥ 900 cm²
≥ 700 cm²

- snaga vode - 12
- težina - 312
- promjer - Ø 200
- kapacitet vode - 52 l
- učinkovitost - 78%
- raspon snage - 11-30
- temperatura plinova - 305
- radni tlak - 2

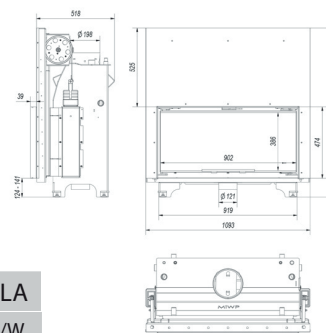



ŠIFRA VOKEL	BOJA	SNAGA	ŠIFRA ARTIKLA
1446005	CRNA	24 kW	MILA/PW/24/G/W

ZUZIA/PW/19/W/DECO

UGRADNI KAMIN NA DRVA ZA CENTRALNO GRIJANJE

 snaga vode - 15

 promjer - Ø 200

 učinkovitost - 75%

 radni tlak - 2

 temperatura plinova - 295

 težina - 199

 kapacitet vode - 40,5 l

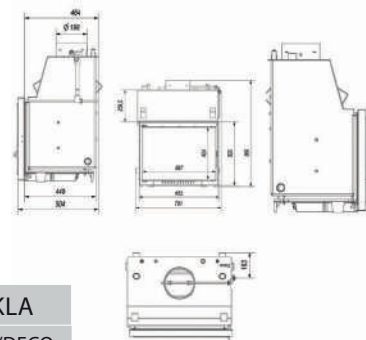
 raspon snage - 10-24

ŠIFRA VOKEL	BOJA	SNAGA	ŠIFRA ARTIKLA
1446060	CRNA	19 kW	ZUZIA/PW/19/W/DECO

NOVEMBER

BIO KAMIN NA BIOETANOL



težina - 52

materijal

1,2

ŠIFRA VOKEL	BOJA	DIMENZIJE [cm]	ŠIFRA ARTIKLA
1446019	BIJELA	115x29,5x101,3	NOVEMBER

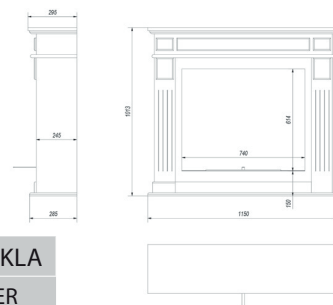
OSCAR

BIO KAMIN NA BIOETANOL



težina - 25

materijal

1,2

ŠIFRA VOKEL	BOJA	DIMENZIJE [cm]	ŠIFRA ARTIKLA
1446018	CRNA	90x19,5x63	OSCAR/CZARNY

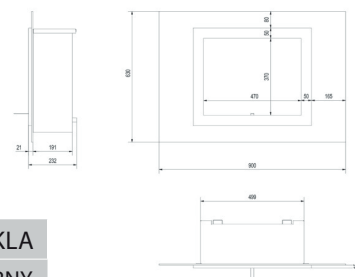
PLANET

BIO KAMIN NA BIOETANOL



težina - 81

materijal

1,6

ŠIFRA VOKEL	BOJA	DIMENZIJE [cm]	ŠIFRA ARTIKLA
1446020	BIJELA	81x33,1x97,5	PLANET

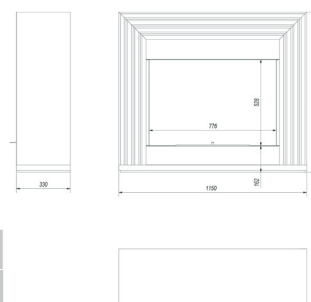
HOTEL

BIO KAMIN NA BIOETANOL



težina - 15,5

materijal

1,2

ŠIFRA VOKEL	BOJA	DIMENZIJE [cm]	ŠIFRA ARTIKLA
1446014	CRNA	70x33,4x40	HOTEL

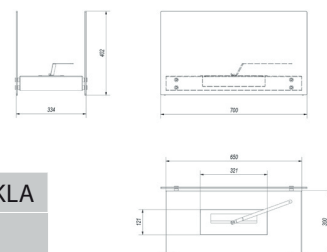

HOTEL MINI

BIO KAMIN NA BIOETANOL



težina - 6

materijal

0,4

ŠIFRA VOKEL	BOJA	DIMENZIJE [cm]	ŠIFRA ARTIKLA
1446013	CRNA	39x23,4x25	HOTEL/MINI

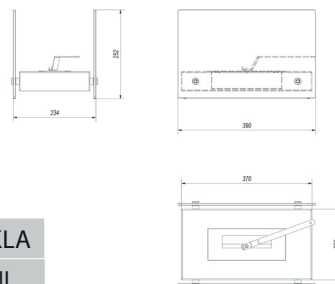

INDIA MINI

BIO KAMIN NA BIOETANOL



težina - 4

materijal

1,2

ŠIFRA VOKEL	BOJA	DIMENZIJE [cm]	ŠIFRA ARTIKLA
1446015	CRNA	34x15,5x7	INDIA/MINI

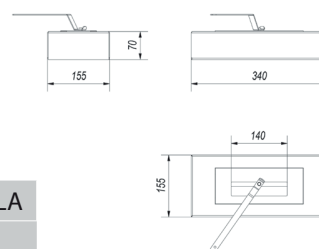

TANGO 1

BIO KAMIN NA BIOETANOL



težina - 3,5

materijal

0,44

ŠIFRA VOKEL	BOJA	DIMENZIJE [cm]	ŠIFRA ARTIKLA
1446016	CRNA	20x20x38	TANGO 1

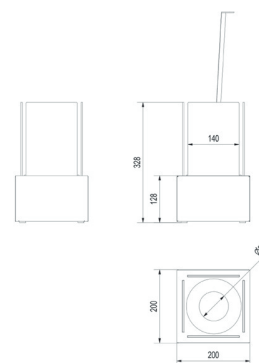

ROMEO

BIO KAMIN NA BIOETANOL



težina - 19

materijal

1,2

ŠIFRA VOKEL	BOJA	DIMENZIJE [cm]	ŠIFRA ARTIKLA
1446017	CRNA	35,9x20,9x113,55	ROMEO



OKRUGLA REŠETKA

Ø 125

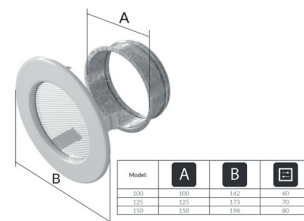

ŠIFRA VOKEL	BOJA	DIMENZIJE [mm]	ŠIFRA ARTIKLA
1446022	BIJELA	Ø125	FI/125B

ČETVRTASTA REŠETKA SA MOGUĆNOŠĆU ZATVARANJA

17 x 17 cm

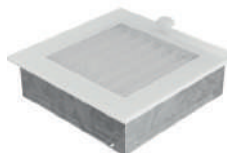

ŠIFRA VOKEL	BOJA	DIMENZIJE [cm]	ŠIFRA ARTIKLA
1446025	BIJELA	17x17	17BX

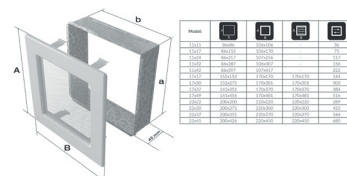
PRAVOKUTNA REŠETKA SA MOGUĆNOŠĆU ZATVARANJA

17 x 30 cm

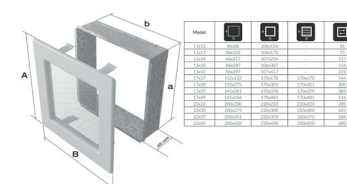

ŠIFRA VOKEL	BOJA	DIMENZIJE [cm]	ŠIFRA ARTIKLA
1446026	BIJELA	17x30	30BX

ČETVRTASTA REŠETKA SA MOGUĆNOŠĆU ZATVARANJA

17 x 17 cm

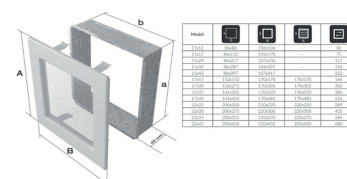

ŠIFRA VOKEL	BOJA	DIMENZIJE [cm]	ŠIFRA ARTIKLA
1446023	GRAFIT	17x17	17GX

PRAVOKUTNA REŠETKA SA MOGUĆNOŠĆU ZATVARANJA

17 x 30 cm

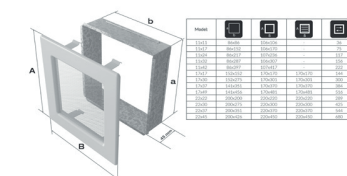

ŠIFRA VOKEL	BOJA	DIMENZIJE [cm]	ŠIFRA ARTIKLA
1446024	GRAFIT	17x30	30GX

ČETVRTASTA REŠETKA OSCAR SA MOGUĆNOŠĆU ZATVARANJA

17x17

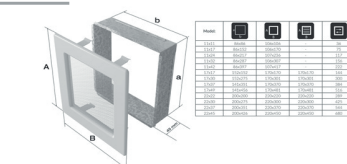

ŠIFRA VOKEL	BOJA	DIMENZIJE [mm]	ŠIFRA ARTIKLA
1446027	BIJELA	17x17	17OBX

PRAVOKUTNA REŠETKA OSCAR SA MOGUĆNOŠĆU ZATVARANJA

17 x 30 cm

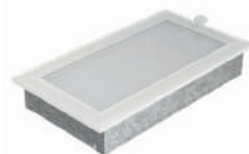

ŠIFRA VOKEL	BOJA	DIMENZIJE [cm]	ŠIFRA ARTIKLA
1446028	BIJELA	17x30	30OBX



RAVNA VENTILACIJSKA KANALICA

LUFT



ŠIFRA VOKEL	BOJA	DIMENZIJE [cm]	ŠIFRA ARTIKLA
1446030	BIJELA	6x60	LUFT/6/60/45S/B
1446053	CRNA	6x60	LUFT/6/60/45S/C
1446055	BIJELA	9x60	LUFT/9/60/45S/B
1446057	CRNA	9x60	LUFT/9/60/45S/C



Model	X	Y
LUFT/6/20/45S/B	200	51
LUFT/6/40/45S/B	400	111
LUFT/6/60/45S/B	600	171
LUFT/6/80/45S/B	800	231
LUFT/6/100/45S/B	1000	291

RAVNA VENTILACIJSKA KANALICA

LUFT



ŠIFRA VOKEL	BOJA	DIMENZIJE [cm]	ŠIFRA ARTIKLA
1446029	BIJELA	6 x 80	LUFT/6/80/45S/B
1446054	CRNA	6 x 80	LUFT/6/80/45S/C
1446056	BIJELA	9 x 80	LUFT/9/80/45S/B
1446058	CRNA	9 x 80	LUFT/9/80/45S/C



Model	X	Y
LUFT/6/80/45S/B	800	111
LUFT/6/100/45S/B	1000	171
LUFT/9/80/45S/B	800	231
LUFT/9/100/45S/B	1000	291

KUTNA VENTILACIJSKA KANALICA

LUFT



ŠIFRA VOKEL	BOJA	DIMENZIJE [cm]	ŠIFRA ARTIKLA
1446032	BIJELA	76,6 x 54,7 x 6	LUFT/NL/60/45S/B
1446047	BIJELA	54,7 x 76,6 x 9	LUFT/NP/90/45S/B
1446033	BIJELA	54,7 x 76,6 x 6	LUFT/NP/60/45S/B
1446048	BIJELA	76,6 x 54,7 x 9	LUFT/NL/90/45S/B

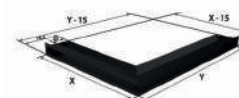

Model	X	Y	Z
LUFT/NL/60/45S/B	547	547	260
LUFT/NP/90/45S/B	766	547	336
LUFT/NP/60/45S/B	547	766	336
LUFT/NL/90/45S/B	766	547	336

KUTNA VENTILACIJSKA KANALICA

LUFT



ŠIFRA VOKEL	BOJA	DIMENZIJE [cm]	ŠIFRA ARTIKLA
1446052	CRNA	76,6 x 54,7 x 6	LUFT/NL/60/45S/C
1446049	CRNA	54,7 x 76,6 x 9	LUFT/NP/90/45S/C
1446051	CRNA	74,7 x 76,6 x 6	LUFT/NP/60/45S/C
1446050	CRNA	76,6 x 54,7 x 9	LUFT/NL/90/45S/C

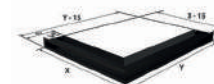

Model	X	Y	Z
LUFT/NL/60/45S/C	547	547	261
LUFT/NP/90/45S/C	766	547	336
LUFT/NP/60/45S/C	547	766	336
LUFT/NL/90/45S/C	766	547	336

CIJEV S Klapnom

ZA REGULACIJU DOVODA ZRAKA Ø 125



ŠIFRA VOKEL	DIMENZIJE [mm]	ŠIFRA ARTIKLA
1446031	Ø125	P125/R

CIJEV S KLAPNOM

ZA REGULACIJU DOVODA ZRAKA Ø 125 : Ø 100

ŠIFRA VOKEL	DIMENZIJE [Ø]	ŠIFRA ARTIKLA
1446068	100	P100
1446059	125	P125

DOLOT/KROCIEC

PRIKLJUČAK ZA VANJSKI DOVOD ZRAKA

ŠIFRA VOKEL	ŠIFRA ARTIKLA
1446045	DOLOT/KROCIEC

PDR90

CIJEVNI ADAPTER

ŠIFRA VOKEL	DIMENZIJE [mm]	ŠIFRA ARTIKLA
1446064	25x152 (Ø100)	PDR90/100
1446065	25x152 (Ø125)	PDR90/125

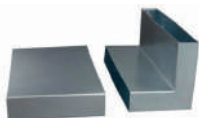
DOLOT/PRZEJSCIE

DOVOD ZRAKA - KUTNI 90 ° ILI 360 °

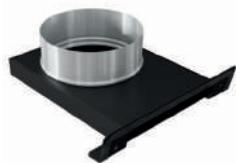

ŠIFRA VOKEL	PRIJELAZ OD ULAZA [°]	ŠIFRA ARTIKLA
1446066	90 °	DOLOT/PRZEJSCIE/90
1446067	360 °	DOLOT/PRZEJSCIE/360

DOLOT/ZELIWO

PRIKLJUČAK ZA VANJSKI DOVOD ZRAKA Ø100 ili Ø125

ŠIFRA VOKEL	DIMENZIJE [Ø]	ŠIFRA ARTIKLA
1446069	100	DOLOT/ZELIWO/100
1446070	125	DOLOT/ZELIWO/125

RED/S/200/180

DIMOVODNA REDUKCIJA Ø200/180

ŠIFRA VOKEL	VELIČINA [Ø]	ŠIFRA ARTIKLA
1446063	200/180	RED/S/200/180



TASMA/170 - TASMA350

JEDNOSTRANA LJEPLJIVA ALU TRAKA

ŠIFRA VOKEL	BOJA	OTPORNOST [do °C]	ŠIFRA ARTIKLA
1446061	SREBRNA	170 °C	TASMA/170
1446062	SREBRENA	350 °C	TASMA/350



PLYN/PIANKA

SRETSTVO ZA ČIŠĆENJE STAKLA

ŠIFRA VOKEL	BOJA	DIMENZIJE [ml]	ŠIFRA ARTIKLA
1446041	-	500	PLYN/PIANKA



SENZUR/W/P/K/6x3

UŽE ZA STAKLO NA KAMINU S LJEPLJIVOM TRAKOM 1m

ŠIFRA VOKEL	DIMENZIJE [mm]	ŠIFRA ARTIKLA
1446046	6x3	SENZUR/W/P/K/6X3

ZUZIA/G

UGRADNI KAMIN NA DRVA



- snaga - 16
- težina - 225
- promjer - Ø 200
- dužina drveta - 500 mm
- učinkovitost - 76%
- raspon snage - 7,5 - 21
- temperatura plinova - 355

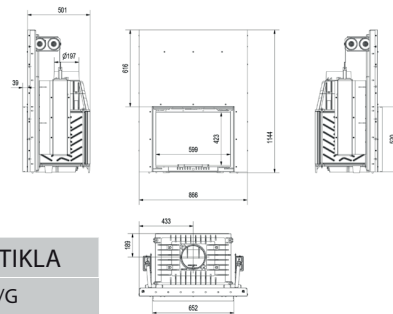

ŠIFRA VOKEL	BOJA	SNAGA	ŠIFRA ARTIKLA
1446071	CRNA	16 kW	ZUZIA/G

ZUZIA/P/BS/G

UGRADNI KAMIN NA DRVA



- snaga - 16
- težina - 243
- promjer - Ø 200
- dužina drveta - 500 mm
- učinkovitost - 76%
- raspon snage - 7,5 - 21
- temperatura plinova - 355

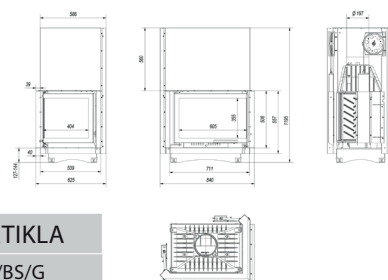

ŠIFRA VOKEL	BOJA	SNAGA	ŠIFRA ARTIKLA
1446072	CRNA	16 kW	ZUZIA/P/BS/G

ZUZIA/L/BS/G

UGRADNI KAMIN NA DRVA



- snaga - 16
- težina - 243
- promjer - Ø 200
- dužina drveta - 500 mm
- učinkovitost - 76%
- raspon snage - 7,5 - 21
- temperatura plinova - 355

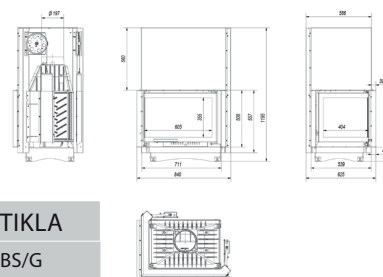

ŠIFRA VOKEL	BOJA	SNAGA	ŠIFRA ARTIKLA
1446073	CRNA	16 kW	ZUZIA/L/BS/G

Fashion



FASHION 80, 100 cm - BOJA DRVETA

ŠIFRA VOKEL	OPIS	Art.
0466503	KUPAONSKI NAMJEŠTAJ FASHION 80 [06271-OGLEDALO 80x68 ALL, 10281-ORMARIĆ BASE 2 LADICE 79x45x54, 10503-KERAMIČKI UMIVAONIK 81x46, 13500-LAMPA LED 5W SMART]	10631
0466506	KUPAONSKI NAMJEŠTAJ FASHION 100 [02295-OGLEDALO 95x68 ALL, 10284-ORMARIĆ BASE 2 LADICE 99x45x54, 10505-KERAMIČKI UMIVAONIK 101x46, 13500-LAMPA LED 5W]	10633
0466509	ORMARIĆ FASHION 25x18x100	10554
0466511	ORMARIĆ I-STYLE S VRATIMA 34x34x13	13073
0466512	ORMARIĆ I-STYLE GIORNO 34x34x13, REVERZIBILNI	13071
0466516	STUB FASHION 34x162x25, REVERZIBILNI, 1 VRATA	13825
0466519	STUB FASHION 34x25x162, REVERZIBILNI, 2 VRATA	13827

Fashion



FASHION 80, 100 cm - BOJA CEMENTO

ŠIFRA VOKEL	OPIS	Art.
0466504	KUPAONSKI NAMJEŠTAJ FASHION 80 [06271-OGLEDALO 80x68 ALL, 10281-ORMARIĆ BASE 2 LADICE 79x45x54, 10503-KERAMIČKI UMIVAONIK 81x46, 13500-LAMPA LED 5W SMART]	10632
0466507	KUPAONSKI NAMJEŠTAJ FASHION 100 [02295-OGLEDALO 95x68 ALL, 10284-ORMARIĆ BASE 2 LADICE 99x45x54, 10505-KERAMIČKI UMIVAONIK 101x46, 13500-LAMPA LED 5W SMART]	10634
0466510	ORMARIĆ FASHION 25x100, CEMENTO	10555
0466513	ORMARIĆ I-STYLE GIORNO 34x34x13, CEMENTO , REVERZIBILNI	13072
0466514	ORMARIĆ I-STYLE S VRATIMA 34x34x13, CEMENTO, REVERZIBILNI	13074
0466517	STUB FASHION 34x162x25, REVERZIBILNI, 1 VRATA, CEMENTO	13826
0466520	STUB FASHION 34x25x162, REVERZIBILNI, 2 VRATA, CEMENTO	13748

Fashion



FASHION 80, 100 cm - BIJELO

ŠIFRA VOKEL	OPIS	Art.
0466502	KUPAONSKI NAMJEŠTAJ FASHION 80 [06271-OGLEDALO 80x68 ALL, 10281-ORMARIĆ BASE 2 LADICE 79x45x54, 10503-KERAMIČKI UMIVAONIK 81x46, 13500-LAMPA LED 5W SMART]	10630
0466505	KUPAONSKI NAMJEŠTAJ FASHION 100 [11206-OGLEDALO 95x68 ALL, 10283-ORMARIĆ BASE 2 LADICE 99x45x54, 10505-KERAMIČKI UMIVAONIK 101x46, 13500-LAMPA LED 5W SMART]	10639
0466508	ORMARIĆ FASHION 25x18x100	10378
0466515	STUB FASHION BIJELO 34x162x25, REVERZIBILNI, 1 VRATA	13750
0466518	STUB FASHION BIJELO 32x25x162, REVERZIBILNI 2 VRATA	13753
0466419	ORMARIĆ I-STYLE GIORNO 34x34x13, BIJELO	07168
0466421	ORMARIĆ I-STYLE S VRATIMA 34x34x13, BIJELO	07171

Athena



ATHENA 03 80 cm - BIANCO

ŠIFRA VOKEL	OPIS	Art.
0466531	KUPAONSKI NAMJEŠTAJ ATHENA 03 80 cm - BIANCO SASTAVLJEN OD: BAZA ATHENA CM 80 1/C 99474 TOP ISDH BIANCO MARMO 81x46	13874
0466532	STUB ATHENA BIANCO REVERZIBILNI 34x162x25	13878

Athena



ATHENA 04 120 cm - BIANCO

ŠIFRA VOKEL	OPIS	Art.
0466533	NAMJEŠTAJ ATHENA 120 BIANCO SASTAVLJENO OD : 13492 BAZA ATHENA CM 1201/C 99476 TOP ISDH BIANCO MARMO 121x46	13875
0466532	STUB ATHENA BIANCO REVERZIBILNI 34x162x25	13878

Athena



ATHENA 04 80 cm - BEIGE/GRIGIO

ŠIFRA VOKEL	OPIS	Art.
0466534	NAMJEŠTAJ ATHENA 04 80CM, BEIGE/GRIGIO RAL 1019 SASTAVLJENO OD : 13493 BAZA ATHENA CM 80 1/C RAL 1019 99451 TOP ISDH NERO 81x46x1,2	13876
0466536	STUB ATHENA RAL 1019, 1/A REVERZIBILNI 34x162	13880

Athena



ATHENA 04 120 cm - BEIGE/GRIGIO

ŠIFRA VOKEL	OPIS	Art.
0466535	NAMJEŠTAJ ATHENA 120 BEIGE GRIGIO RAL1019 SASTAVLJENO OD : 13494 BAZA ATHENA CM 120 1/C RAL 1019 99543 TOP ISDH NERO 121x46x1,2	13877
0466536	STUB ATHENA RAL 1019 1/A REVERZIBILNI 34x162	13880

Athena



ATHENA 01 80 cm - VERDE/BLUE

ŠIFRA VOKEL	OPIS	Art.
0466529	KUPAONSKI NAMJEŠTAJ ATHENA 01 80 cm - BOJA VERDE BLU (PLAVO/ZELENA) RAL 6004, SASTAVLJEN OD: 13491 BAZA ATHENA CM 80 1/C-RAL6004 13501 UMIVAONIK DOMUS	13873
0466530	ORMARIĆ ATHENA 25x100 BOJA VERDE BLU (PLAVO/ZELENA), ral 6004, REVERZIBILNI 25x18x100	10559

Mary



MARY 01 105 cm - TELEGRIGIO

ŠIFRA VOKEL	OPIS	Art.
0466537	KUPAONSKI NAMJEŠTAJ MARY 01 105 cm RAL 7046, SASTAVLJENO OD 05185 BAZA MARY 74x45 2/C RAL 7046, 10614 BOČNA BAZA A GIORNO ISDH 30x45 NERO, 99462 TOP ISHD NERO 105x46x1,2	05186
0466538	STUP ATHENA RAL 7046, REVERZIBILNI 1/A 34x162 TELEGRIGIO	13881

Modula



MODULA 110 cm - NODATO CEMENTO

ŠIFRA VOKEL	OPIS	Art.
0466539	KUPAONSKI NAMJEŠTAJ MODULA 110/1 ROVERE NODATO CEMENTO, 110x40x46	12432
0466509	ORMARIĆ FASHION BOJA DRVETA - REVERE NODATO, REVERZIBILNI	10554
0466510	ORMARIĆ FASHION, BOJA CEMENTO REVERZIBILNI 25x18x100	10555
0466511	ORMARIĆ I-STYLE S VRATIMA, BOJA DRVETA - ROVERE NODATO (HRAST) REVERZIBILNI 34x34x13	13073
0466512	ORMARIĆ I-STYLE GIORNO, BOJA DRVETA - ROVERE NODATO (HRAST) REVERZIBILNI 34x34x13	13071
0466513	ORMARIĆ I-STYLE GIORNO, BOJA CEMENTO REVERZIBILNI, 34x34x13	13072
0466514	ORMARIĆ I-STYLE S VRATIMA, BOJA CEMENTO REVERZIBILNI 34x34x13	13074
0466516	STUB FASHION, BOJA DRVETA ROVERE NODATO (HRAST) REVERZIBILNI 1 VRATA, 34x162x25	13825
0466517	STUB FASHION, BOJA CEMENTO REVERZIBILNI 1 VRATA 34x162x25	13826
0466519	STUB FASHION, BOJA DRVETA - ROVERE NODATO (HRAST) REVERZIBILNI 2 VRATA 34x25x162	13827
0466520	STUB FASHION, BOJA CEMENTO REVERZIBILNI 2 VRATA 34x25x162	13748



Šifra Vokel	Opis	Dimenzije	Art.
0466522	OGLEDALO OMEGA LED SVJETLO 5W, 105x90 cm	105x90	13705
0466523	OGLEDALO OMEGA LED SVJETLO 5W, 80x90 cm	80x90	13704



Šifra Vokel	Opis	Art.
0466524	OGLEDALO OMICRON LED SVJETLO 28W	13707



WOMAN
LED, CRNI OKVIR

Šifra Vokel	Opis	Dimenzije	Art.
0466525	OGLEDALO WOMAN LED SVJETLO 28W	80x65	13762
0466526	OGLEDALO WOMAN LED SVJETLO 32W	100x65	13765
0466527	OGLEDALO WOMAN LED SVJETLO 36W	120x65	13768
0466528	OGLEDALO WOMAN LED SVJETLO 40W	140x65	13771



Katalog proizvoda

Ivana

60-190

60-130

60-190 1L

60-130 1L

40-190

30-190 SK

40-190 1L

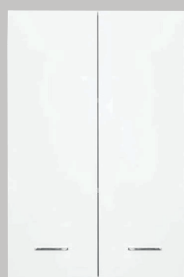
40-130

60-90 S

60-85 3L

**SHELF RIVA 50
SHELF RIVA 60
KLO FA LED 80 S**
IVANA

ŠIFRA VOKEL	OPIS	Art.
1107046	KUPAONSKI ORMAR IVANA 60-190	2069
1107047	KUPAONSKI ORMAR IVANA 60-130	2076
1107048	KUPAONSKI ORMAR IVANA 40-190	2090
1107080	KUPAONSKI ORMAR IVANA 40-130	2106
1107112	KUPAONSKI ORMAR IVANA 33-190 SK	1003783
1107113	KUPAONSKI ORMAR IVANA 60-90 S	1091704
1107114	KUPAONSKI ORMAR IVANA 60-85 3L	1091506
1107115	KUPAONSKI ORMAR IVANA 40-190 1L	1091605
1107116	KUPAONSKI ORMAR IVANA 60-130 1L	1091681
1107117	KUPAONSKI ORMAR IVANA 60-190 1L	1091988
1107136	KUPAONSKI ORMAR S OGLEDALOM SHELF RIVA 50	427143
1107134	KUPAONSKI ORMAR S OGLEDALOM SHELF RIVA 60	427150
1107111	KUPAONSKI ORMAR S OGLEDALOM KLO FA LED 80 S	427174

Luxury



LUXURY RIVA SCK 80



LUXURY DROP 80 S



LUXURY 40/170 S

LUXURY 80 cm

ŠIFRA VOKEL	OPIS	Art.
1107087	ORMARIĆ S OGLEDALOM LUXURY RIVA SCK 80 BIJELO VISOKI SJAJ	428515
1107118	KUPAONSKI ORMAR LUXURY DROP 80 S BLOCK, BIJELO VISOKI SJAJ	1081842
1107088	KUPAONSKI ORMAR SA STRANE LUXURY 40/170 S, BIJELO VISOKI SJAJ	427501

Albatros



VIVA 55
VIVA 65
VIVA 75
VIVA 85



SHELF RIVA 50
SHELF RIVA 60
KLO FA LED 80 S

ili



ALBATROS 55



ALBATROS 65



ALBATROS 80

ALBATROS 55, 65, 80 cm

ŠIFRA VOKEL	OPIS	Art.
1107106	KUPAONSKI ORMAR S OGLEDALOM VIVA 55	421738
1107103	KUPAONSKI ORMAR ALBATROS 55 BLOK	1092725
1107107	KUPAONSKI ORMAR S OGLEDALOM VIVA 65	421745
1107104	KUPAONSKI ORMAR ALBATROS 65 BLOK	1092732
1107135	KUPAONSKI ORMAR S OGLEDALOM VIVA 75	421752
1107108	KUPAONSKI ORMAR S OGLEDALOM VIVA 85	421769
1107105	KUPAONSKI ORMAR ALBATROS 80 BLOK	1092749

Absolute

ABSOLUTE 80/37
ABSOLUTE 60/37, 80/37 cm

ŠIFRA VOKEL	OPIS	Art.
1107119	KUPAONSKI ORMAR ABSOLUTE 60/37 S BLOK	1082375
1107120	KUPAONSKI ORMAR ABSOLUTE 80/37 S BLOK	1082252

SNOW

LUXURY 40/170

SNOW 78/2 DRAW

SNOW 60/2 DRAW
SNOW 60/2, 78/2 cm

ŠIFRA VOKEL	OPIS	Art.
1107121	KUPAONSKI ORMAR SNOW 60/2 DRAW S PLOČOM S/SYNCHRO	1091018
1107122	KUPAONSKI ORMAR SNOW 78/2 DRAW S PLOČOM S/SYNCHRO	1090974
1107123	KUPAONSKI ORMAR LUXURY 40/170 SYNCHRO	1086649

KIARA



OGLEDALO KIARA 80

KIARA 80cm

ŠIFRA VOKEL

OPIS

Art.

1107127

KUPAONSKI ORMAR S OGLEDALOM KIARA 80 S, BIJELO VISOKI SJAJ

1077234

SOFT GAP

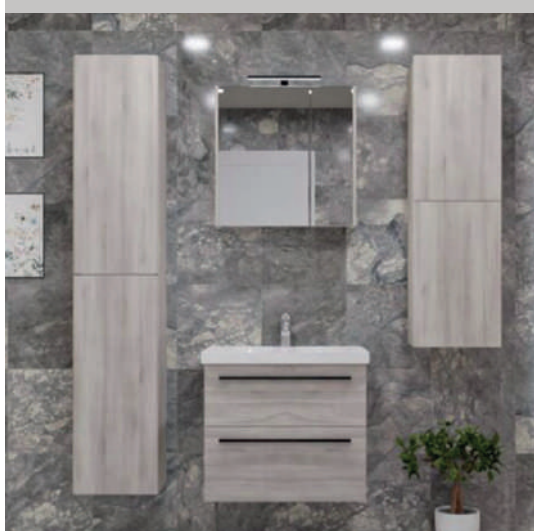

KIARA 65 KRONBERG



SOFT GAP 65 KRONBERG

KIARA 65 - SOFT 65,80 cm

ŠIFRA VOKEL

OPIS

Art.

1107125

KUPAONSKI ORMAR S OGLEDALOM KIARA 65, KRONBERG

1077265

1107124

KUPAONSKI ORMAR SOFT GAP 65 BLOK, KRONBERG

1074943

SOFT GAP

KIARA 65 - SOFT 65,80 cm

ŠIFRA VOKEL	OPIS	Art.
1107126	KUPAONSKI ORMAR SOFT GAP 80 BLOK, WHITE	1074967
1107138	KUPAONSKI ORMAR SOFT GAP 65 S BLOK	1074936
1107139	KUPAONSKI ORMAR SA OGLEDALOM KIARA 30-180	1077227
1107140	KUPAONSKI ORMARIĆ GAMMA-KIARA 30-180	1077326

DROP

LUXURY DROP 80, 78/2, 60/2 cm

ŠIFRA VOKEL	OPIS	Art.
1107128	KUPAONSKI ORMAR DROP 60/2 S PLOČOM CRNO/HALIFAX	1071133
1107129	KUPAONSKI ORMAR DROP 78/2 S PLOČOM CRNO/HALIFAX	1071140
1107130	KUPAONSKI ORMAR DROP 80, CRNO S BIJELIM UMIVAONIKOM	1081859
1107137	KUPAONSKI ORMAR LUXURY 40/170 CRNO MAT	1083129



Elegant 80 cm

FRONTE: troslojno oplemenjeni iveral

KORPUS: troslojno oplemenjeni iveral

DEKOR: hrast authentic

UMIVAONIK: nadgradni

BOJE:



HRAST AUTHENTIC



BIJELI SJAJ

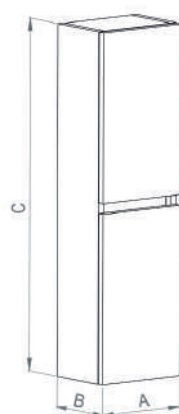

A=25, B=18,5, C=100

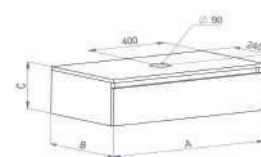

A=80, B=45, C=25



A=80, B=45, C=25

NAMJEŠTAJ ELEGANT 80 HRAST AUTHENTIC

ŠIFRA VOKEL	OPIS
1707011	Elegant 80 ormar gornji, hrast authentic
1707012	Elegant 80 ormar donji, hrast authentic
1707003	Elegant ormar bočni, hrast authentic
1707013	Ogledalo Tiffany 60x80



Elegant 80 cm

FRONTE: MDF obložen PVC folijom

KORPUS: MDF obložen PVC folijom

DEKOR: bijeli sjaj

UMIVAONIK: nadgradni

BOJE:



HRAST AUTHENTIC



BIJELI SJAJ

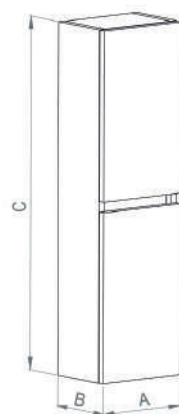

A=25, B=18,5, C=100

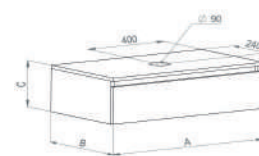

A=80, B=45, C=25

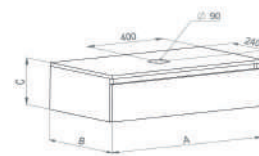

A=80, B=45, C=25

NAMJEŠTAJ ELEGANT 80 BIJELI SJAJ

ŠIFRA VOKEL	OPIS
1707022	Elegant 80 gornji ormarić, bijeli sjaj
1707023	Elegant 80 donji ormarić, bijeli sjaj
1707024	Elegant ormar bočni, bijeli sjaj
1707034	Ogledalo Lynn led 60x80



Iva 80 cm

FRONTE: MDF obložen PVC folijom

KORPUS: MDF obložen PVC folijom

UMIVAONIK: keramički umivaonik

GORNJI DIO OGLEDALO: s policom

RASVJETA: led rasvjeta

BOJE:

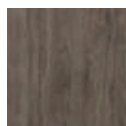

DARKWOOD



BIJELI SJAJ

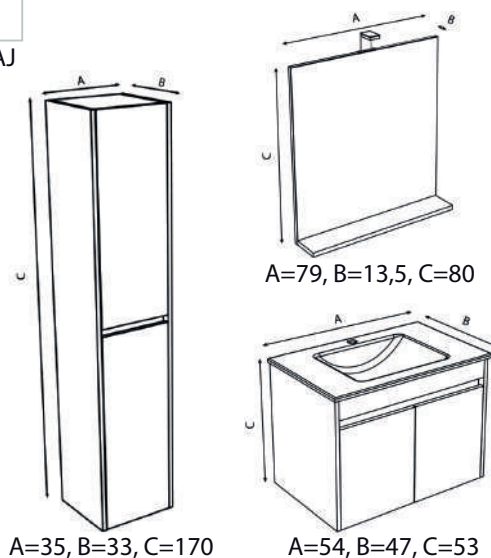

NAMJEŠTAJ IVA 80 BIJELI SJAJ

ŠIFRA VOKEL	OPIS
1707084	Ogledalo Iva 80 (led rasvjeta), bijeli sjaj
1707083	Ormar donji Iva 80, bijeli sjaj
1707066	Ormar bočni Iva 170, bijeli sjaj



Iva 70 cm

FRONTE: MDF obložen PVC folijom

KORPUS: MDF obložen PVC folijom

UMIVAONIK: keramički umivaonik

GORNJI DIO OGLEDALO: s policom

RASVJETA: led rasvjeta

BOJE:



DARKWOOD



BIJELI SJAJ

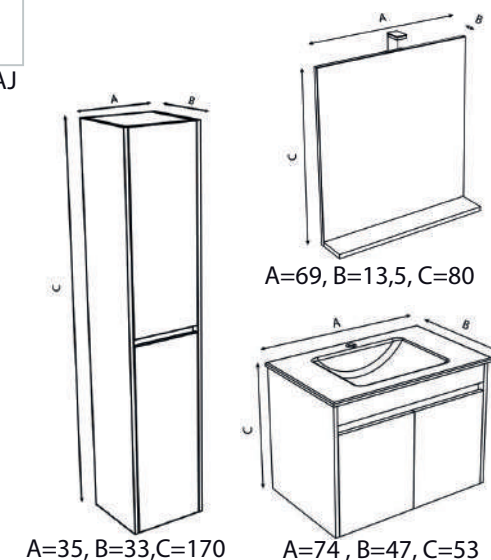

NAMJEŠTAJ IVA 70 BIJELI SJAJ

ŠIFRA VOKEL	OPIS
1707080	Ogledalo Iva 70 (led rasvjeta), bijeli sjaj
1707079	Ormar donji Iva 70, bijeli sjaj
1707066	Ormar bočni Iva 170, bijeli sjaj



Iva 60 cm

FRONTE: MDF obložen PVC folijom

KORPUS: MDF obložen PVC folijom

UMIVAONIK: keramički umivaonik

GORNJI DIO OGLEDALO: s policom

RASVJETA: led rasvjeta

BOJE:



DARKWOOD BIJELI SJAJ

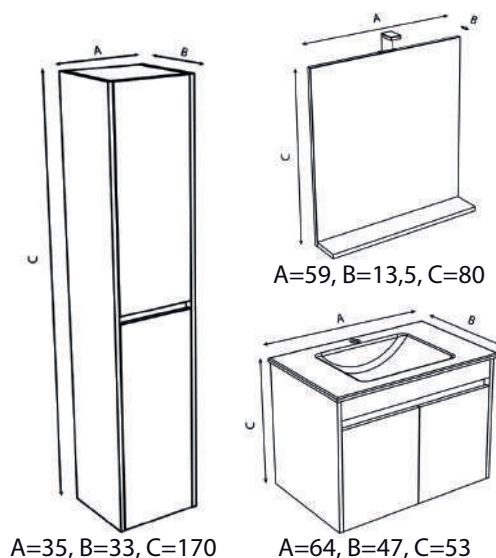

NAMJEŠTAJ IVA 60 BIJELI SJAJ

ŠIFRA VOKEL	OPIS
1707065	Ogledalo Iva 60 (led rasvjeta), bijeli sjaj
1707064	Ormar donji Iva 60, bijeli sjaj
1707066	Ormar bočni Iva 170, bijeli sjaj



Iva 50 cm

FRONTE: MDF obložen PVC folijom

KORPUS: MDF obložen PVC folijom

UMIVAONIK: keramički umivaonik

GORNJI DIO OGLEDALO: s policom

RASVJETA: led rasvjeta

BOJE:



DARKWOOD BIJELI SJAJ

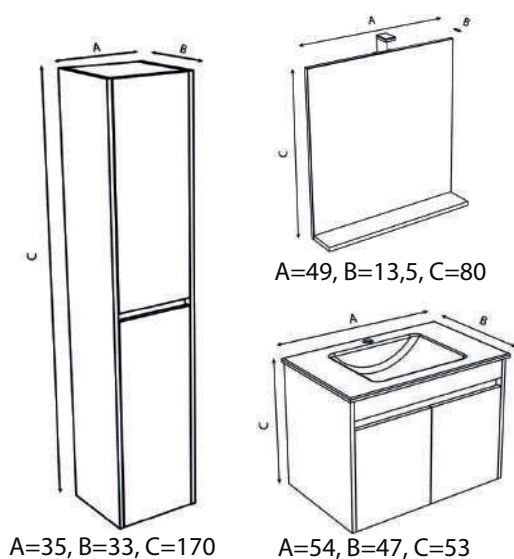

NAMJEŠTAJ IVA 50 BIJELI SJAJ

ŠIFRA VOKEL	OPIS
1707089	Ogledalo Iva 50 (led rasvjeta), bijeli sjaj
1707088	Ormar donji Iva 50, bijeli sjaj
1707066	Ormar bočni Iva 170, bijeli sjaj



Ploča za umivaonik Atlas

KORPUS: troslojno oplemenjeni iveral

GORNJA PLOČA: troslojno oplemenjeni iveral

RUČICE: metal bijela ili antracit

UMIVAONIK: nadgradni

OGLEDALO: ploča od troslojno oplemenjenog iverala s ogledalom

BOJE:



HRAST HALIFAX

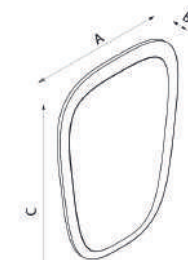

A=64, B=2, C=90

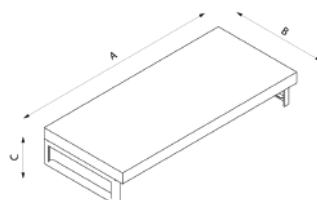

A=80, B=45, C=18

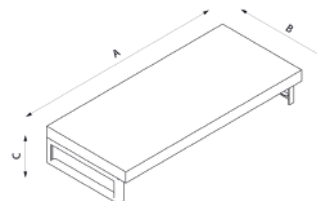

A=100, B=45, C=18

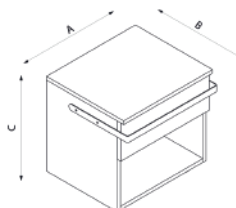

A=50, B=51, C=46

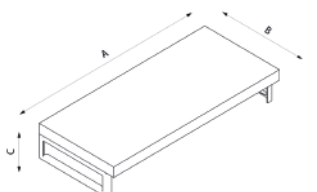

A=120, B=45, C=18

PLOČA ZA UMIVAONIK ATLAS

ŠIFRA VOKEL	OPIS
1707025	Ogledalo Atlas 64x90
1707014	Atlas ploča za umivaonik 80 cm
1707015	Atlas ploča za umivaonik 100 cm
1707016	Atlas ploča za umivaonik 120 cm
1707017	Nosač ploče Atlas, antracit
1707018	Nosač ploče Atlas, bijeli



Veil 50

FRONTE: MDF obložen PVC folijom
KORPUS: MDF obložen PVC folijom
DEKOR: kronberg
UMIVAONIK: keramički
GORNJI ORMARIĆ: led rasvjeta s prekidačem
BOJE:



KRONBERG

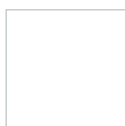

BIJELI MAT

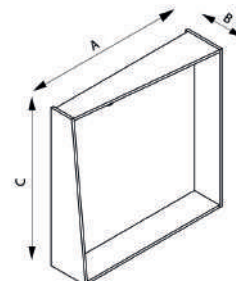

A=50, B=15, C=60

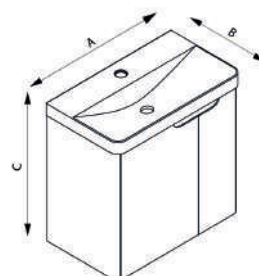

A=50, B=38, C=57

NAMJEŠTAJ VEIL 50 KRONBERG

ŠIFRA VOKEL	OPIS
1707029	Ogledalo Veil 50 , kronberg
1707010	Namještaj Veil 50, kronberg



Veil 50

FRONTE: MDF obložen PVC folijom
KORPUS: MDF obložen PVC folijom
DEKOR: bijeli
UMIVAONIK: keramički
GORNJI ORMARIĆ: led rasvjeta s prekidačem
BOJE:

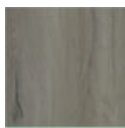

KRONBERG



BIJELI MAT

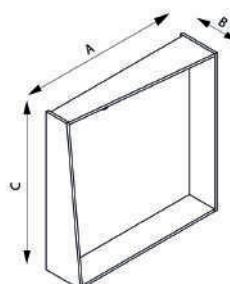

A=50, B=15, C=60

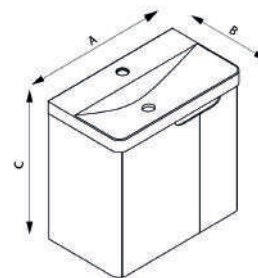

A=50, B=38, C=57

NAMJEŠTAJ VEIL 50 KRONBERG

ŠIFRA VOKEL	OPIS
1707029	Ogledalo Veil 50 , kronberg
1707021	Namještaj Veil 50, bijelo



Smart 75

FRONTE: MDF obložen PVC folijom
KORPUS: MDF obložen PVC folijom
UMIVAONIK: nadgradni umivaonik

BOJE:



BIJELO

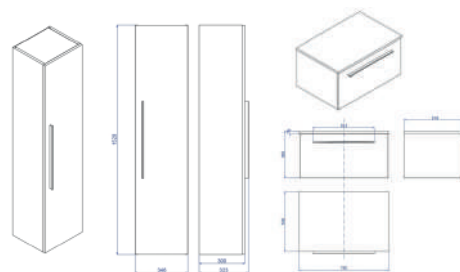

NAMJEŠTAJ SMART 75 BIJELO - ZLATNA RUČKA

ŠIFRA VOKEL	OPIS
1707108	Ormar donji Smart, bijelo - sjaj
1707109	Ormar bočni 150 Smart, bijelo - sjaj



Smart 75

FRONTE: MDF obložen PVC folijom
KORPUS: MDF obložen PVC folijom
UMIVAONIK: nadgradni umivaonik

BOJE:



BIJELO

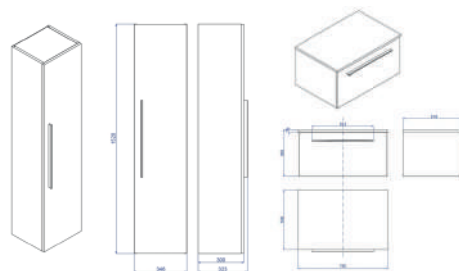

NAMJEŠTAJ SMART 75 BIJELO - CRNA RUČKA

ŠIFRA VOKEL	OPIS
1707110	Ormar donji Smart, bijelo - sjaj
1707111	Ormar bočni 150 Smart, bijelo - sjaj



OGLEDALO VITA

Ø70

ŠIFRA VOKEL	OPIS	Ø	Artikal
1707027	Ogledalo Vita 70, led rasvjeta	70	042250



OGLEDALO FRAME

Ø70

ŠIFRA VOKEL	OPIS	Ø	Artikal
1707032	Ogledalo Frame 70, led rasvjeta	70	15276



OGLEDALO FRAME

50x100

ŠIFRA VOKEL	OPIS	Dimenzije (cm)	Artikal
1707033	Ogledalo Frame 50x100, led rasvjeta	50x100	15274



OGLEDALO FRAME

60x80

ŠIFRA VOKEL	OPIS	Dimenzije (cm)	Artikal
1707086	Ogledalo Frame 60x80, led	60x80	15275



OGLEDALO SHINE - SENZORSKO

60x80

ŠIFRA VOKEL	OPIS	Dimenzije (cm)	Artikal
1707060	Ogledalo Shine 60x80, senzorsko	60x80	042121



OGLEDALO SHINE - SENZORSKO

80x100

80x120

ŠIFRA VOKEL	OPIS	Dimenzije (cm)	Artikal
1707061	Ogledalo Shine 80x100, senzorsko	80x100	042122
1707062	Ogledalo Shine 80x120, senzorsko	80x120	042123



OGLEDALO SHINE - SENZORSKO

60x80

ŠIFRA VOKEL	OPIS	Dimenzije (cm)	Artikal
1707060	Ogledalo Shine 60x80, senzorsko.	60x80	042121



OGLEDALO SHINE - LED SENZOR

Ø80

ŠIFRA VOKEL	OPIS	Ø	Artikal
1707063	Ogledalo Shine 80, led senzor.	80	042124



OGLEDALO LYNN

60x80

ŠIFRA VOKEL	OPIS	Dimenzije (cm)	Artikal
1707034	Ogledalo Lynn 60x80, led rasvjeta.	60x80	00897

Galaxy

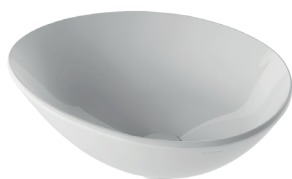

NADGRADNI UMIVAONIK

51,1x41 cm

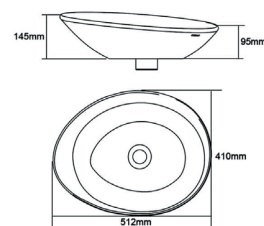

ŠIFRA VOKEL

OPIS

Art.

0462421

NADGRADNI UMIVAONIK GALAXY

116985

Nysa



NADGRADNI UMIVAONIK

35x35 cm

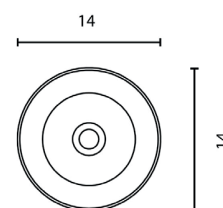

ŠIFRA VOKEL

OPIS

Art.

0462422

NADGRADNI UMIVAONIK NYSA

125816

Nomia



NADGRADNI UMIVAONIK

50x39 cm

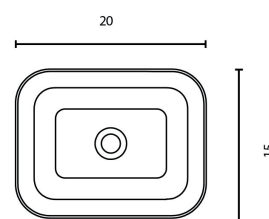

ŠIFRA VOKEL

OPIS

Art.

0462429

NADGRADNI UMIVAONIK NOMIA

125818

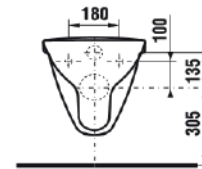
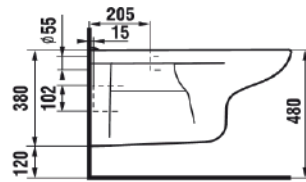
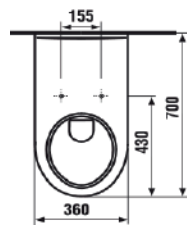

Šifra Vokel	Opis	Art.
1174002	VIŠEĆA WC ŠKOLJKA ZA INVALIDE DEEP JIKA	820642000001

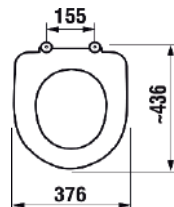

Šifra Vokel	Opis	Art.
1174001	WC DASKA DEEP JIKA	8932813000631

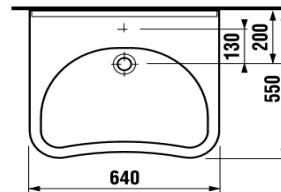
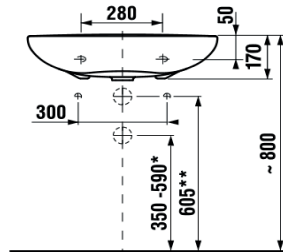

Šifra Vokel	Opis	Art.
1174003	UMIVAONIK ZA INVALIDE MIO 640x550 JIKA	8137140001041

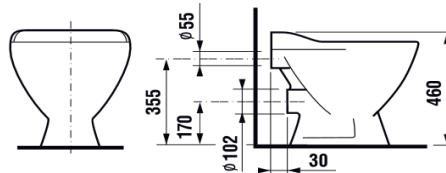
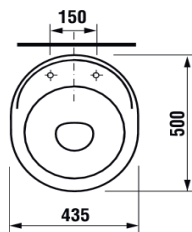

Šifra Vokel	Opis	Art.
1174004	TROKADERO STOJEĆI MIRA S PLASTIČNOM REŠETKOM JIKA	8510460000001

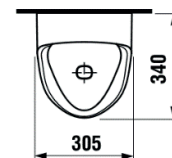
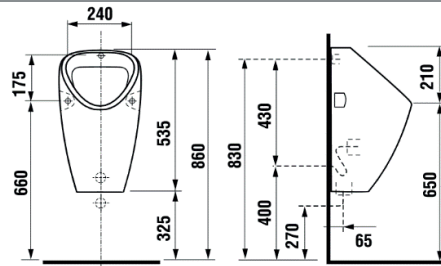

Šifra Vokel	Opis	Art.
1174005	PISOAR GOLEM	8430600000001



Adele

Kolekcije sanitarnog porculana

	<p>1109193</p> <p>1109191</p> <p>1109194</p> <p>1109195</p>	<p>WC ŠKOLJKA ADELE STOJEĆA ODVOD U POD ART.344196000</p> <p>WC ŠKOLJKA ADELE STOJEĆA ODVOD U ZID ART.344195000</p> <p>WC DASKA ADELE SPOROSPUŠTAJUĆA ART.A80129200P</p> <p>WC DASKA ADELE OBIČNA ART.A80129000P</p>
	<p>1109196</p>	<p>BIDE STOJEĆI ADELE ART.355195000</p>

	1109195	WC DASKA ADELE OBIČNA ART.A80129000P
---	----------------	---

ONA

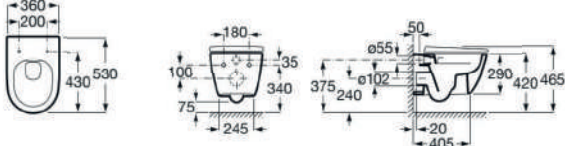
 	1109234	WC ŠKOLJKA VISEĆA ONA 530 RIMLESS ART. A346687000
--	----------------	--

	1109235	WC DASKA ONA SPOROSPUŠTAJUĆA SUPRALIT ART. A801E12001
---	----------------	---

  	<p>0459030</p>	<p>WC ŠKOLJKA SERIJA 130 ODVOD U POD ART.B40CBO06</p>
	<p>0459032</p>	<p>WC POKLOPAC SERIJA 130 ART.B41DE025</p>
	<p>0459033</p>	<p>TUŠ SJEDALICA ZIDNA NA PREKLAPANJE NOSIVOSTI 150 kg ART.4FAUHS01</p>



DUPLI KERAMIČKI UMIVAONIK

120 cm

* 27.5 kg (+- %5)
* 163 x 1210 x 450 mm

ŠIFRA VOKEL	BOJA	ŠIFRA ARTIKLA	PAKIRANJE
1177001	BIJELA	4120-KL	1

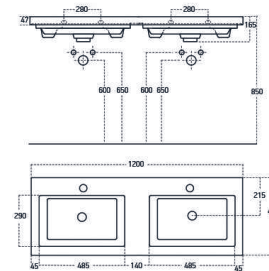

KERAMIČKI UMIVAONIK

100 cm

* 20.4 kg (+- %5)
* 170 x 1050 x 450 mm

ŠIFRA VOKEL	BOJA	ŠIFRA ARTIKLA	PAKIRANJE
1177002	BIJELA	4100-KL	1

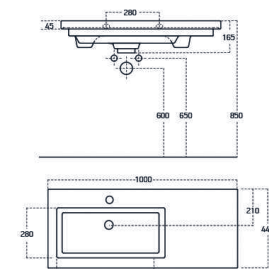

KERAMIČKI UMIVAONIK

85 cm

* 18.1 kg (+- %5)
* 170 x 855 x 450 mm

ŠIFRA VOKEL	BOJA	ŠIFRA ARTIKLA	PAKIRANJE
1177003	BIJELA	4085-KL	1

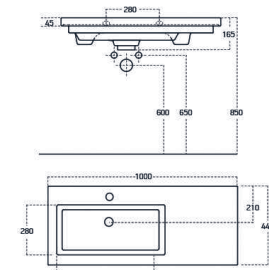

KERAMIČKI UMIVAONIK

70 cm

* 14.1 kg (+- %5)
* 160 x 715 x 448 mm

ŠIFRA VOKEL	BOJA	ŠIFRA ARTIKLA	PAKIRANJE
1177004	BIJELA	4070-KL	1

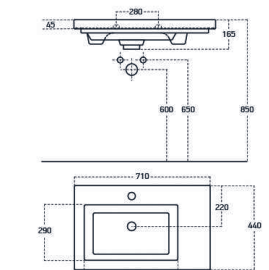

KERAMIČKI UMIVAONIK

60 cm

* 10.1 kg (+- %5)
* 170 x 550 x 450 mm

ŠIFRA VOKEL	BOJA	ŠIFRA ARTIKLA	PAKIRANJE
1177005	BIJELA	4060-KL	1

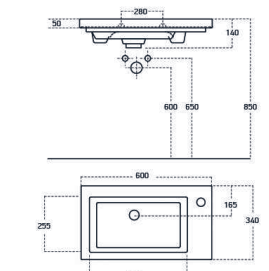

KERAMIČKI UMIVAONIK

45 cm

* 5.7 kg (+- %5)
* 150 x 507 x 277 mm

ŠIFRA VOKEL	BOJA	ŠIFRA ARTIKLA	PAKIRANJE
1177006	BIJELA	4045-KL	1

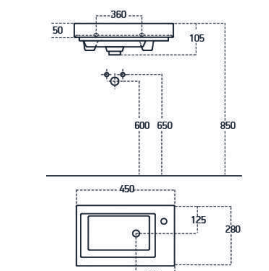



KERAMIČKI NADPULTNI UMIVAONIK

65 cm

- * 14,1 kg (+- %5)
- * 175 x 655 x 483 mm

ŠIFRA VOKEL	BOJA	ŠIFRA ARTIKLA	PAKIRANJE
1177007	BIJELA	3066-KL	1

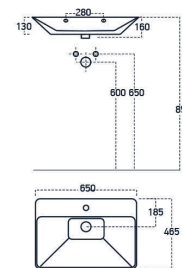

KERAMIČKI NADPULTNI UMIVAONIK

55 cm

- * 14,4 kg (+- %5)
- * 148 x 555 x 505 mm

ŠIFRA VOKEL	BOJA	ŠIFRA ARTIKLA	PAKIRANJE
1177008	BIJELA	3054-KL	1

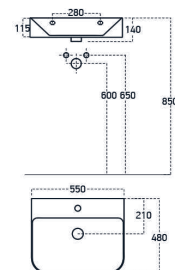

KERAMIČKI NADPULTNI UMIVAONIK

50 cm

- * 12,2 kg (+- %5)
- * 160 x 510 x 490 mm

ŠIFRA VOKEL	BOJA	ŠIFRA ARTIKLA	PAKIRANJE
1177009	BIJELA	7050-KL	1

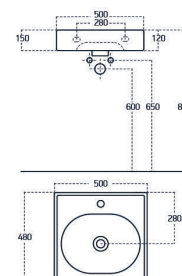

KERAMIČKI NADPULTNI UMIVAONIK

50 cm

- * 13,4 kg (+- %5)
- * 105 x 500 x 380 mm

ŠIFRA VOKEL	BOJA	ŠIFRA ARTIKLA	PAKIRANJE
1177011	BIJELA	3050-KL	1

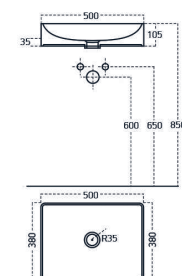

KERAMIČKI NADPULTNI UMIVAONIK

Ø43 cm

- * 9,2 kg (+- %5)
- * 130 x 430 x 430 mm

ŠIFRA VOKEL	BOJA	ŠIFRA ARTIKLA	PAKIRANJE
1177010	BIJELA	3034-KL	1

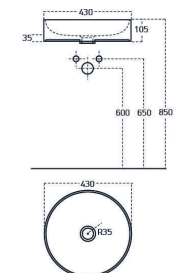



VISEĆA WC ŠKOLJKA

GARCIA_BRILLA

- * 23,6 kg (+- %5)
- * 375 x 535 x 375 mm
- * volumen : 0.078 m³

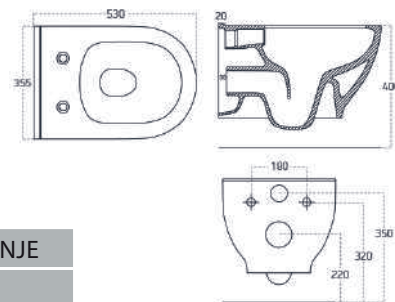

ŠIFRA VOKEL	BOJA	ŠIFRA ARTIKLA	PAKIRANJE
1177016	BIJELA	100614	1



VISEĆI BIDE

GARCIA

ŠIFRA VOKEL	BOJA	ŠIFRA ARTIKLA	PAKIRANJE
1177014	BIJELA	100624	1



HIGIJENSKA VISEĆA WC ŠKOLJKA

GARCIA_RIMLESS

- * 23,6 kg (+- %5)
- * 375 x 535 x 375 mm
- * volumen : 0.078 m³

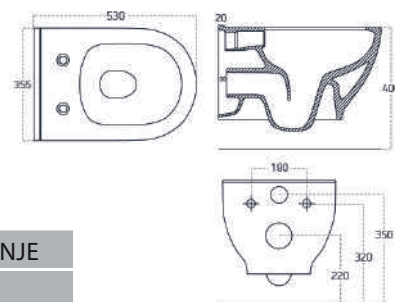

ŠIFRA VOKEL	BOJA	ŠIFRA ARTIKLA	PAKIRANJE
1177015	BIJELA	100612	1



VISEĆA WC ŠKOLJKA

RIMLESS AVANGARD



ŠIFRA VOKEL	BOJA	ŠIFRA SRTIKLA	PAKIRANJE
1177020	BIJELA	100314	1

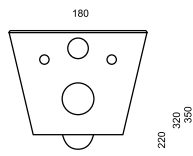
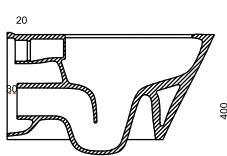
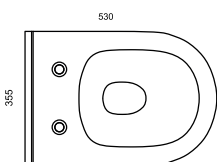

HIGIJENSKA VISEĆA WC ŠKOLJKA

RIMLESS AVANGARD BEZ VENTILA



ŠIFRA VOKEL	BOJA	ŠIFRA SRTIKLA	PAKIRANJE
1177021	BIJELA	100312	1

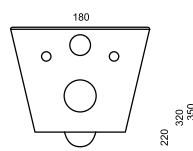
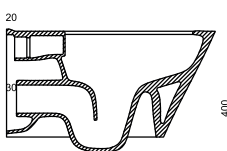
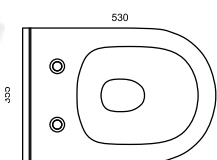

HIGIJENSKA VISEĆA WC ŠKOLJKA

RIMLESS AVANGARD S UGRAĐENIM VENTILOM



ŠIFRA VOKEL	BOJA	ŠIFRA SRTIKLA	PAKIRANJE
1177018	BIJELA	100315	1

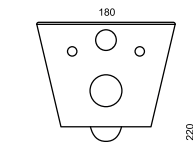
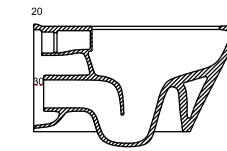
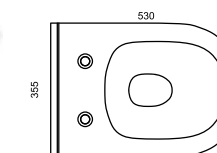

VISEĆI BIDE

AVANGARD



ŠIFRA VOKEL	BOJA	ŠIFRA SRTIKLA	PAKIRANJE
1177019	BIJELA	100324	1

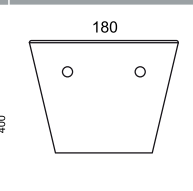
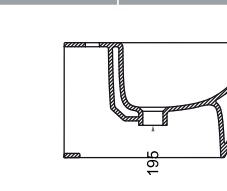
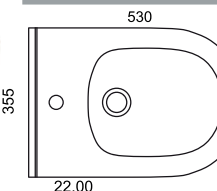

BATERIJA ZA UMIVAONIK

SAMO ARMATURA

ŠIFRA VOKEL	BOJA	ŠIFRA ARTIKLA	PAKIRANJE
1725001	KROM	00077	1

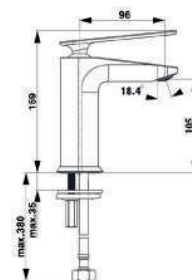
BATERIJA ZA BIDE

SAMO ARMATURA

ŠIFRA VOKEL	BOJA	ŠIFRA ARTIKLA	PAKIRANJE
1725004	KROM	00530	1

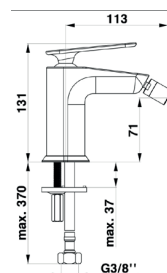
BATERIJA ZA KADU

SAMO ARMATURA

ŠIFRA VOKEL	BOJA	ŠIFRA ARTIKLA	PAKIRANJE
1725002	KROM	00330	1

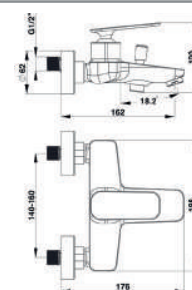
BATERIJA ZA TUŠ

SAMO ARMATURA

ŠIFRA VOKEL	BOJA	ŠIFRA ARTIKLA	PAKIRANJE
1725003	KROM	00430	1

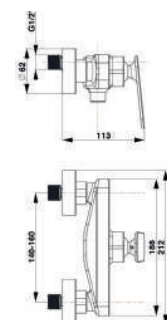



BATERIJA ZA UMIVAONIK

SAMO ARMATURA

ŠIFRA VOKEL	BOJA	ŠIFRA ARTIKLA	PAKIRANJE
1725005	CRNO	00077B	1

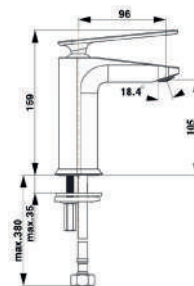

BATERIJA ZA BIDE

SAMO ARMATURA

ŠIFRA VOKEL	BOJA	ŠIFRA ARTIKLA	PAKIRANJE
1725008	CRNO	00430	1

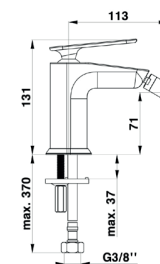

BATERIJA ZA KADU

SAMO ARMATURA

ŠIFRA VOKEL	BOJA	ŠIFRA ARTIKLA	PAKIRANJE
1725006	CRNO	00330B	1

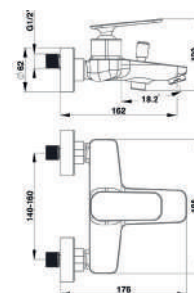

BATERIJA ZA TUŠ

SAMO ARMATURA

ŠIFRA VOKEL	BOJA	ŠIFRA ARTIKLA	PAKIRANJE
1725007	CRNO	00430B	1

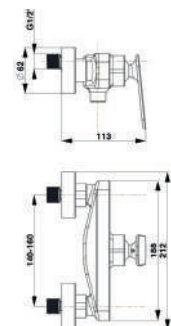



CORSICA
UNIVERZALNA WC DASKA

ŠIFRA VOKEL	OPIS	BOJA	ART.
0479001	THERMOPLAST	BIJELA	522986



BALTIC
UNIVERZALNA WC DASKA

ŠIFRA VOKEL	OPIS	BOJA	ART.
0479003	DUROPLAST	BIJELA	507415



STREAM
ZA WC ŠKOLJKU VALENTINA

ŠIFRA VOKEL	OPIS	BOJA	ART.
0479004	DUROPLAST	BIJELA	533482



SPRING
ZA WC ŠKOLJKU VALENTINA

ŠIFRA VOKEL	OPIS	BOJA	ART.
0479008	DUROPLAST	BIJELA	519131



WAVE SOFTCLOSE
ZA WC ŠKOLJKU VALENTINA SA AMORTIZERIMA

ŠIFRA VOKEL	OPIS	BOJA	ART.
0479011	DUROPLAST	BIJELA	520279



COMO SOFTCLOSE
UNIVERZALNA WC DASKA

ŠIFRA VOKEL	OPIS	BOJA	ART.
0479015	DUROPLAST	BIJELA	521906



BALTIC TOP FIX

ŠIFRA VOKEL	OPIS	BOJA	ART.
0479019	DUROPLAST	BIJELA	528530



FLUKE ECO SOFTCLOSE TAKE OFF

ŠIFRA VOKEL	OPIS	BOJA	ART.
0479022	DUROPLAST	BIJELA	532316



PERCA SOFTCLOSE

ŠIFRA VOKEL	OPIS	BOJA	ART.
0479024	DUROPLAST	BIJELA	534043



REVO

ŠIFRA VOKEL	OPIS	BOJA	ART.
0479025	DUROPLST	BIJELA	534998, 536026, 533948

BACAN (BANOCA) TAKE OFF
ZA WC ŠKOLJKU LAUFEN PRO NEW

ŠIFRA VOKEL	OPIS	BOJA	ART.
0479026	DUROPLAST	BIJELA	531412, 532430

RAY SOFTCLOSE
ZA WC ŠKOLJKU LAUFEN PRO

ŠIFRA VOKEL	OPIS	BOJA	ART.
0479027	DUROPLAST	BIJELA	531339



RAY SOFTCLOSE TAKE OFF

ZA WC ŠKOLJKU LAUFEN PRO NEW, AVANGARD, GARCIA, VELA

ŠIFRA VOKEL	OPIS	BOJA	ART.
0479028	DUROPLAST	BIJELA	536117



RAY SOFTCLOSE TOP FIX







ZA WC ŠKOLJKU MAGIS

ŠIFRA VOKEL	OPIS	BOJA	ART.
0479030	DUROPLAST	BIJELA	531784, 533421



PICCO 2.0 SOFTCLOSE TAKE OFF

ŠIFRA VOKEL	OPIS	BOJA	ART.
0479029	DUROPLAST	BIJELA	539987

	<p>12433</p> <p>12434</p> <p>0526151</p> <p>0526148</p>	<p>KUĆIŠTE 3/4 ZA FILTER ART.FHPR34</p> <p>KUĆIŠTE 1" ZA FILTER ART.FHPRI</p> <p>GUMICA ZA KUĆIŠTE 5coll OR-APC</p> <p>GUMICA ZA KUĆIŠTE 10coll OR-AQYT</p>
	<p>12444</p>	<p>FILTER ZA PROČIŠĆAVANJE VODE ART.FCPS20</p>
	<p>12717</p>	<p>FILTER ZA OMEKŠAVANJE VODE ART.FCCST</p>
	<p>12716</p>	<p>FILTER ZA PROČIŠĆAVANJE VODE I UKLANJANJE KLORA ART.FCCBL</p>
	<p>0526144</p> <p>0526143</p> <p>0526145</p>	<p>FILTER PATRONA SITO ART.FCPNN 50M</p> <p>FILTER PATRONA SITO ART.FCPNN 100 M</p> <p>FILTER PATRONA SITO ART.FCPNN 150M-A</p>
	<p>12985</p>	<p>FILTER ZA VODU ART. FHCTF</p>

Ventilator BWN100WS

Š.Vokel
Opis
0207069 | VENTILATOR BVN 100 WS ART.474564

Tehničke karakteristike:

 Snaga motora **15 W**

 Protok zraka: **70 m³/h**

 Razina buke (max.): **33dB**

 Broj okretaja: **2.400 okr/min**

 Način ugradnje: **na zid, strop, prozor**

 Boja: **Bijela**

 Visina (A): **158 mm**

 Dubina do zida (B): **21 mm**

 Duljina odvodne cijevi (C): **55 mm**

 Promjer odvodne cijevi (D): **98 mm**

 Promjer otvora u zidu: **100 mm**

 Dimenzije zapakiranog aparata (ŠxVxD): **16,2 x 8 x 16,5 cm**

 Neto težina aparata: **0,5 kg**

 Bruto težina aparata: **0,59 kg**

Ventilator se jednostavno uključuje pritiskom prekidača

Kombinirani bojler 80 Litara / lijevi

TGRK80LNG

pod pritiskom/tlačni



Visokokvalitetna izolacija

Š.VOKEL	OPIS
0207071	BOJLER TGRK 80 LNG ART.479159

Vrsta bojlera: **pod pritiskom/ tlačni**
 Profil upotrebe: **M**
 Energetski razred: **C**
 Energetska učinkovitost zagrijavanja vode nwh: **36 %**
 Potrošnja energije kWh/24 h: **6,7 kWh**
 Podešavanje temperature termostata: **eco**
 Smart vrijednost: **0**
 Zapremina: **71,3 l**

Broj odvodnih mjesta: **2 ili više**
 Način montaže: **Vertikalno na zid**

Priključni na vodovodnu mrežu: **G 1/2**
 Izmjenjivač topline: **G 3-4**

Radni pritisak: **6 bar**
 Materijal kotla: **Čelični emajlirani lim**
 Zaštitna anoda: **Zaštitna magnezijumska anoda**
 Regulacija temperature: **Elektromehanička**
 Termometar: **Bimetalni termometar**
 Zaštita od zamrzavanja: **Da**
 Signalno svjetlo - prikaz grijanja: **Da**

Površina izmjenjivača: **0,25 m2**
 Maksimalni pritisak: **6 bar**
 Maksimalna temperatura: **85 °C**

Broj električnih grijača: **1**
 Priklijuna snaga: **2.000 W**
 Priključni napon: **230 V**
 Nazivna struja: **8,7 A**

Toplotni gubitci (kWh/24) - vertikalna montaža: **1,32 kWh/24**

Dimenzije aparata (ŠxVxD): **45,4 × 79 × 46,1 cm**
 Dimenzije aparata u ambalaži (ŠxVxD): **48,8 × 80 × 49,8 cm**
 Masa aparata: **31 kg**
 Bruto težina aparata: **33 kg**
 Osigurač: **10 A**

Kombinirani bojler 80 Litara / desni

TGRK80DNG

pod pritiskom/tlačni



Visokokvalitetna izolacija

Š.VOKEL	OPIS
0207072	BOJLER TGRK 80 DNG ART.479160

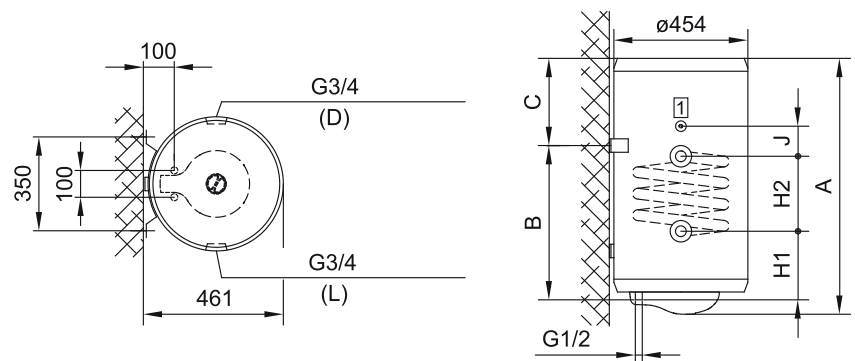

	A	B	C	H1	H2	J
TGRK 80 D/L	790	565	205	222	200	80

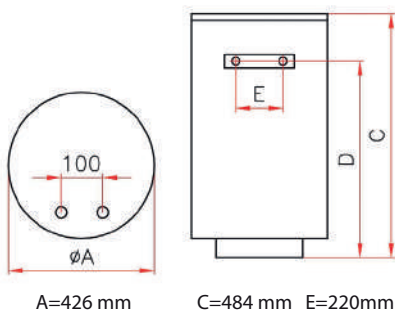
**35 LITARA**

- Boja: Bijela
- Volumen: 35 litara
- Jedno ili više odljernih mjesta: +
- Pričvršćenje: okomito na zid
- Broj osoba uz prosječnu uporabu: 1-2
- Priključci za vodu: G=1/2"
- Masa praznog / s vodom: 14/49 kg
- Radni tlak: 8 bar
- Sigurnosni ventil 6 bara
- Nazivna snaga: 1500 W
- Nazivni napon: 230 V ~

ŠIFRA VOKEL	OPIS	ŠIFRA ARTIKLA
0209032	BOJLER KONČAR 35 litara VANJSKA REGULACIJA EGV35C2RA	TYLS00

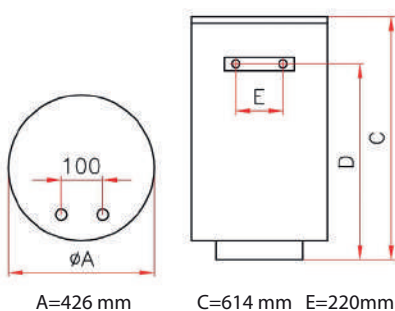
**50 LITARA**

- Boja: Bijela
- Volumen: 50 litara
- Jedno ili više odljernih mjesta: +
- Pričvršćenje: okomito na zid
- Broj osoba uz prosječnu uporabu: 2-3
- Priključci za vodu: G=1/2"
- Masa praznog / s vodom: 16/66 kg
- Radni tlak: 8 bar
- Sigurnosni ventil 6 bara
- Nazivna snaga: 1980 W
- Nazivni napon: 230 V ~

ŠIFRA VOKEL	OPIS	ŠIFRA ARTIKLA
0209033	BOJLER KONČAR 50 litara UNUTARNJA REGULACIJA EGV50C2TA	TYNA00

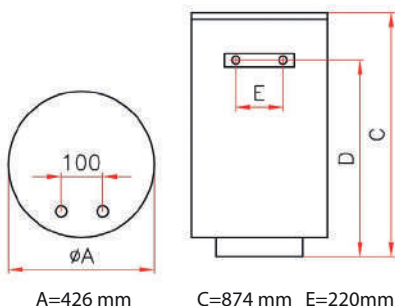
**80 LITARA**

- Boja: Bijela
- Volumen: 80 litara
- Jedno ili više odljernih mjesta: +
- Pričvršćenje: okomito na zid
- Broj osoba uz prosječnu uporabu: 3-4
- Priključci za vodu: G=1/2"
- Masa praznog / s vodom: 21/101 kg
- Radni tlak: 8 bar
- Sigurnosni ventil 6 bara
- Nazivna snaga: 1980 W
- Nazivni napon: 230 V ~

ŠIFRA VOKEL	OPIS	ŠIFRA ARTIKLA
0209034	BOJLER KONČAR 80 litara UNUTARNJA REGULACIJA EGV80C2TA	TYND00

LYDOS ECO

novo



WATER-PLUS
TEHNOLOGIJA



EKO EVO
FUNKCIJA



POTPUNI
SIGURNOSNI
SUSTAV



ENERGETSKI
UČINKOVIT



ZAŠTIĆENO
TITANOM



TALIJANSKI
DIZAJN



SPREMAN ZA
TUŠIRANJE



LED ZASLON

NAPREDNI UČINAK

WaterPlus tehnologija: do 16% više dostupne tople vode

Eko Evo funkcija powered by CoreTech: do 14% uštede energije

U skladu s najvišim propisima ESWH-a

PUNA UDOBNOST

Ručno i precizno podešavanje temperature

Ikona spremna za tuširanje koja prikazuje prvu dostupnost tuširanja

Apsolutni sigurnosni sustav koji štiti dobro funkcioniranje proizvoda

T-MAX funkcija suočava se s neočekivanom potrebom tople vode

JEDNOSTAVNO KVALITETAN

Vrhunski i robusan izolacijski materijal koji je prihvatljiv za okoliš

Magnezijeva anoda za borbu protiv korozije

Visokokvalitetni titanski emajlirani spremnik

EKSKLUZIVNI PROJEKT

100% napravljen i dizajniran u Italiji

Moderni oblik s "Ariston valom" i optimiziran plastični poklopac

LED HMI za jednostavne i brze povratne informacije o proizvodu

High-Tech korisničko sučelje

Tehnički podaci		50 V	80 V	100 V
Instalacija		Okomito	Okomito	Okomito
Kapacitet	l	50	80	100
Snaga	kW	2	2	2
Vrijeme zagrijavanja(ΔT = 45°C)	h:min.	1:18'	1:58'	2:29'
Maks. radna temperatura	°C	80	80	80
Toplinski gubici na 65°C	kWh/24h	0,99	1,35	1,56
Maksimalni radni tlak	bar	8	8	8
Težina	kg	16	20,5	24
IP zaštita	IP	IPX3	IPX3	IPX3
Višina/Širina/Dubina	mm	528/450/470	733/450/470	885/450/470
Energetski razred		B	B	B
Profil kapaciteta		M	M	M

Š.Vokel

Opis

0211080 BOJLER LYDOS ECO 50 lit ART.3201860

0211081 BOJLER LYDOS ECO 80 lit ART.3201861



PRO 1 R VTD/VTS EU

80-100 lt



WATER-PLUS
TEHNOLOGIJA



REGULACIJA
VANJSKE
TEMPERATURE



TERMOSTAT ZA
DVOSTRUKU
SIGURNOST



UČINKOVITA
IZOLACIJA



ZAŠTIĆENO
TITANOM



TALIJANSKI
DIZAJN

novo



NAPREDNI UČINAK

WaterPlus tehnologija: do 16% više dostupne tople vode
U skladu s najvišim propisima ESWH-a

PUNA UDOBNOST

Ručno i precizno podešavanje temperature

JEDNOSTAVNO KVALITETAN

Vrhunski i robustan izolacijski materijal koji je prihvatljiv za okoliš
Moderan talijanski dizajn
Magnezijeva anoda za borbu protiv korozije
Visokokvalitetni titanski emajlirani spremnik testiran na 16 bara

Tehnički podatci		PRO 1 R 80 VTD	PRO 1 R 80 VTS	PRO 1 R 100 VTD	PRO 1 R 100 VTS
Instalacija		Okomito	Okomito	Okomito	Okomito
Kapacitet	l	80	80	100	100
Snaga	kW	1,8	1,8	1,8	1,8
Vrijeme zagrijavanja($\Delta T = 45^{\circ}C$)	h:min.	2:11'	2:11'	2:46'	2:46'
Maks. radna temperatura	$^{\circ}C$	75	75	75	75
Toplinski gubici na $65^{\circ}C$	kWh/24h	1,51	1,51	1,62	1,62
Maksimalni radni tlak	bar	8	8	8	8
Težina	kg	21,5	21,5	25	25
IP zaštita	IP	IPX3	IPX3	IPX3	IPX3
Višina/Širina/Dubina	mm	748/450/480	748/450/480	900/450/480	900/450/480
Energetski razred		C	C	C	C
Profil kapaciteta		M	M	L	L

Š.Vokel

Opis

0211084 BOJLER KOMBINIRANI PRO1R 100 lit LIJEVI ART.3201817



PRO 1 ECO EU

120-150 lt



WATER-PLUS
TEHNOLOGIJA



EKO EVO
FUNKCIJA



POTPUNI
SIGURNOSNI
SUSTAV



EKO ZASLON



ZAŠTIĆENO
TITANOM



TALIJANSKI
DIZAJN



SPREMAN ZA
TUŠIRANJE



UČINKOVITA
IZOLACIJA

UZ SVE KARAKTERISTIKE MODELA PRO 1 R MODEL JE NADOGRAĐEN FUNKCIJAMA:

- / ECO EVO FUNKCIJA SA CORETECH
TEHNOLOGIJOM: DO 14% UŠTEDE
- / PRIKAZ DOSTUPNOSTI VODE ZA PRVO TUŠIRANJE
- / T-MAX FUNKCIJA ZA BRŽU PRIPREMU TOPLE VODE
- / VIZUALIZACIJA POMOĆU LED SUSTAVA

Tehnički podatci		120	150
Instalacija		Okomito	Okomito
Kapacitet	I	120	150
Snaga	kW	2	2
Vrijeme zagrijavanja(ΔT = 45°C)	h:min.	3:08'	3:55'
Maks. radna temperatura	°C	80	80
Toplinski gubici na 65°C	kWh/24h	1,6	1,65
Maksimalni radni tlak	bar	8	8
Težina	kg	27,6	32,4
IP zaštita	IP	IPX3	IPX3
Višina/Širina/Dubina	mm	1108/450/470	1283/450/470
Energetski razred		C	C
Profil kapaciteta		L	L

Š.Vokel

Opis

0211085 BOJLER PRO1 ECO R 150 lit ART.3700569



PRO 1 R

50-80-100 lt



WATER-PLUS
TEHNOLOGIJA



REGULACIJA
VANJSKE
TEMPERATURE



TERMOSTAT ZA
DVOSTRUKU
SIGURNOST



UČINKOVITA
IZOLACIJA



ZAŠTIĆENO
TITANOM



TALIJANSKI
DIZAJN

NAPREDNI UČINAK

WaterPlus tehnologija: do 16% više dostupne tople vode
U skladu s najvišim propisima ESWH-a

PUNA UDOBNOST

Ručno i precizno podešavanje temperature
Jednostavno korisničko sučelje sa povratnom informacijom o grijanju

JEDNOSTAVNO KVALITETAN

Vrhunski i robustan izolacijski materijal koji je prihvatljiv za okoliš
Magnezijeva anoda za borbu protiv korozije
Moderan talijanski dizajn
Visokokvalitetni titanski emajlirani spremnik testiran na 16 bara

Tehnički podatci		50V	80V	100V
Instalacija		Okomito	Okomito	Okomito
Kapacitet	l	50	80	100
Snaga	kW	2	2	2
Vrijeme zagrijavanja($\Delta T = 45^{\circ}\text{C}$)	h:min.	1:18'	1:58'	2:29'
Maks. radna temperatura	$^{\circ}\text{C}$	75	75	75
Toplinski gubici na 65°C	kWh/24h	0,99	1,35	1,56
Maksimalni radni tlak	bar	8	8	8
Težina	kg	16	20,5	24
IP zaštita	IP	IPX3	IPX3	IPX3
Višina/Širina/Dubina	mm	543/450/480	748/450/480	900/450/480
Energetski razred		/	/	/
Profil kapaciteta		/	/	/

Š.Vokel Opis

0211082	BOJLER PRO1R 50V 50 lit S VANJSKOM REGULACIJOM ART.3201810
0211083	BOJLER PRO1R 80V 80 lit S VANJSKOM REGULACIJOM ART.3201811



VELIS PRO WIFI



PAMETNI IZBORNIK



SPREMAN TUŠ



FUNKCIJA ECO EVO



GRUČAČI ELEMENT
EMAJLIJIRAN
LEGUROM
INCOLOY



SIGURNOSNI PAKET



TITANIJ PLUS



PLOSNAT



VIŠE POLOŽAJA



TALIJANSKI DIZAJN

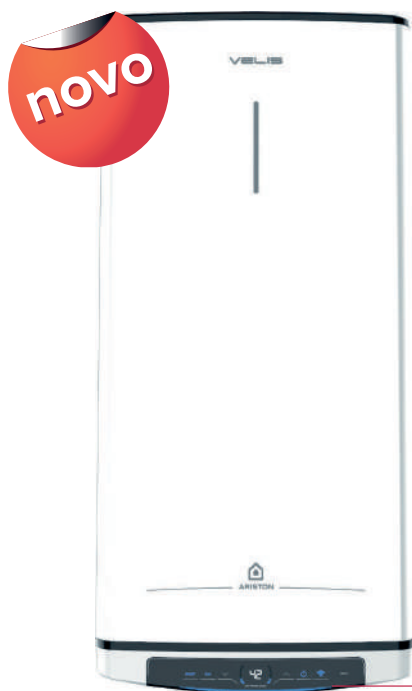

PAMETNI ZASLON

- / Moderan i ekskluzivan dizajn
- / Multifunkcionalni LCD displej
- / Instalacija Više pozicija H/V

- / Funkcija ECO EVO (patentirano)
- / Funkcija spreman za tuširanje

- / Izoliran od buke, emajliran
- / Kotao od emajliranog titana na 850°C
- / Dvostruka magnezijaska dioda



KATEGORIJA
NAJBOLJI
ENERGETSKI RAZRED*

PAMETNI zaslon osjetljiv na dodir Blue Tech

- / Broj dostupnih tuširanja
- / Vrijeme čekanja do sljedećeg tuširanja
- / Dnevno programiranje



PAMETNA struktura dvostrukog spremnika: topao tuš spreman je za



TEHNIČKI PODACI

VLS EVO 50

VLS EVO 80

VLS EVO 100

		50	80	100
Kapacitet	l	50	80	100
Instalacija		Više položaja (V/H)/više položaja (V/H)/više položaja (V/H)		
Snaga	KW	1,5	1,5	1,5
Napon	V	230	230	230
Vrijeme zagrij. ($\Delta T=45^{\circ}\text{C}$)	h,min	1,34	2,16	2,47
Vrijeme zagrij ($\Delta T=50^{\circ}\text{C}$)	h,min	1,44	2,31	2,06
Maks. radni tlak	bar	8	8	8
Maks. radna temperatura	$^{\circ}\text{C}$	80	80	80
Težina	Kg	23,5	31	35,5
Zaštita	IP	IPX4	IPX4	IPX4

UKUPNE DIMENZIJE

	mm	776	1066	1251
a	mm	776	1066	1251
b	mm	405	695	880

VELIS EVO

	50 EU	80 EU	100 EU
Energetska klasa	B	B	B
Oznaka kapaciteta	M	M	M
TVORNIČKI ARTIKL	3100945	3100946	3100947

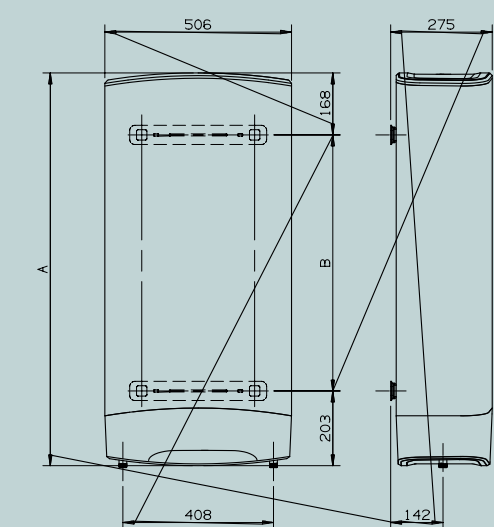



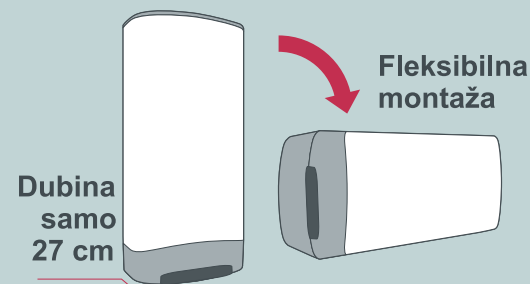

Vertikalna/horizontalna montaža



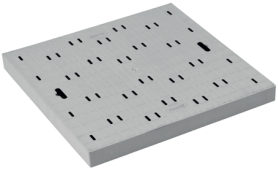
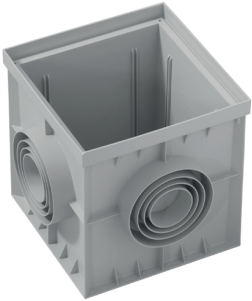
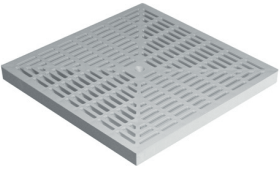

Š.Vokel Opis

0211093	BOJLER VELIS PRO WIFI 50 lit	ART.3100945
0211094	BOJLER VELIS PRO WIFI 80 lit	ART.3100946

OMOGUĆIO
Core**TECH**

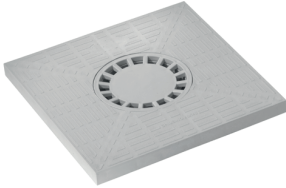
	Šifra Vokel	Opis	Art.
	0170001	Kanalica modularna 100x35x1000 mm dakota Pegasus Plus s rešetkom - siva.	POZ90-1335P
	0170002	Završni komad Dakota za kanalicu h-35, set sivi.	POZ95-1335T
	0170003	PP poklopac pješački 200x200 mm sa ručkom.	POZ02-1348M
	0170004	PP poklopac pješački 300x300 mm sa ručkom.	POZ02-1358M
	0170005	PP poklopac pješački 400x400 mm sa ručkom.	POZ02-1368M
	0170006	PP poklopac pješački 550x550 mm sa ručkom.	POZ0-1378AM
	0170007	PP poklopac pješački 700x700 mm sa dvije ručke.	POZ02-7070M
	0170008	PP šaht sa dnom 200x200 mm.	POZ01-1372S
	0170009	PP šaht sa dnom 300x300 mm.	POZ01-1373S
	0170010	PP šaht sa dnom 400x400 mm.	POZ01-1374S
	0170011	PP šaht sa dnom 550x550 mm.	POZ01-1371
	0170012	PP šaht sa dnom 700x700 mm.	POZ01-1370
	0170027	Rešetka za šaht bez ručke 300x300 mm.	POZ03-1357
	0170028	Rešetka za šaht bez ručke 400x400 mm.	POZ03-1367
	0170029	Rešetka za šaht bez ručke 500x500 mm.	POZ03-1377A
	0170030	Rešetka za šaht sa ručkom 300x300 mm.	POZ03-1357M
	0170031	Rešetka za šaht sa ručkom 400x400 mm.	POZ03-1367M
	0170032	Rešetka za šaht sa ručkom 550x550 mm.	POZ03-1377AM

	Šifra Vokel	Opis	Art.
	0170033	Poklopac za šaht sa sifonom 300x300 mm.	POZ09-1361S
	0170034	Poklopac za šaht sa sifonom 400x400 mm.	POZ09-1371S
	0170035	Poklopac za šaht sa sifonom 550x550 mm.	POZ09-1381S
	0170013	Križići 1 mm 200/1.	TER04-1201X
	0170014	Križići 2 mm 200/1.	TER04-1202X
	0170015	Križići šuplji 3 mm 200/1.	TER04-1203
	0170016	Križići šuplji 4 mm 200/1.	TER04-1204X
	0170017	Križići šuplji 5 mm 200/1.	TER04-1205
	0170018	Križići šuplji 7 mm 200/1.	TER04-1207
	0170019	Križići šuplji 10 mm 200/1.	TER04-1200
	0170020	T-Križići 1 mm 200/1.	TER04-1201T
	0170021	T-Križići 2 mm 200/1.	TER04-1202T
	0170022	T-Križići šuplji 3 mm 200/1.	TER04-1204
	0170023	T-Križići šuplji 4 mm 200/1.	TER04-1204T
	0170024	T-Križići šuplji 5 mm 200/1.	TER04-1206
	0170025	T-Križići šuplji 7 mm 200/1.	TER04-1208
	0170026	T-Križići šuplji 10 mm 200/1.	TER04-1201

SET sifon "MINI" za klima uređaje

GLAVNE KARAKTERISTIKE:

- Kolona hidrauličnog zatvaranja od 50 mm
- Gornji dio napravljen od gume
- Unutarnji dijelovi zamjenjivi za periodičnu kontrolu i čišćenje
- Glavno tijelo ima ispust na 90° da bi smanjio ukupnu dimenziju
- Reverzibilno postavljanje desno/lijevo, sa ili bez kutije za ugradnju
- Izlaz za odvodnu rebrastu cijev D18/20
- Dodatno koljeno 90° za vertikalni ispust vode
- Sifon funkcionira jedino u vertikalnom položaju sa gumenom navlakom na ulazu pozicionirana na vrhu.



SET sifon "MINI" RADI BEZ VODE

Sa vertikalnim i horizontalnim izlazom, kompletiran s O - prstenom.

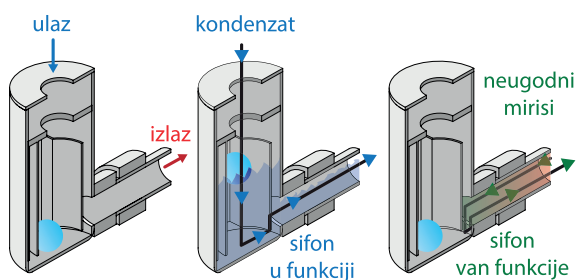

SET sifon "MINI" za klima uređaje



- Sifon
- Kutija s poklopcem i vijcima
- O - prsten
- Brtva

Š.Vokel

Opis

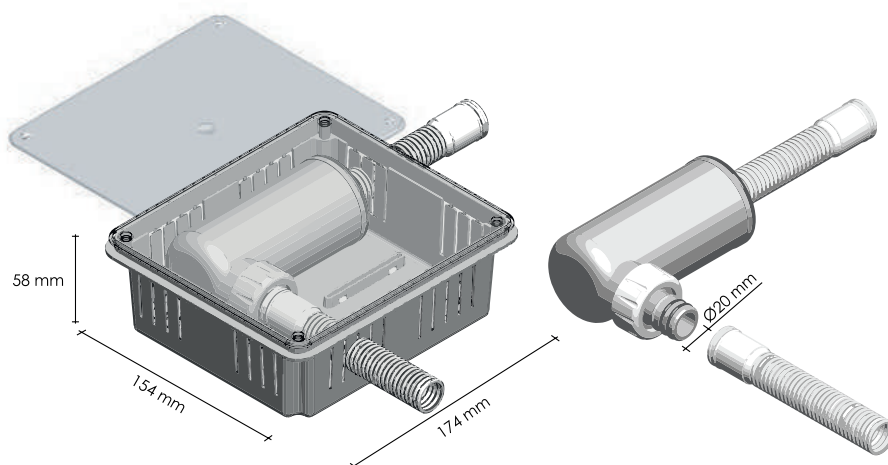
0225092 SET SIFON MINI ZA KLIMA UREĐAJE ART.989924201



	0225095	NIPEL SPOJNICA ZA CIJEVI KLIMA	1/4" - 1/4"	ART.9020071
	0225096	NIPEL SPOJNOICA ZA CIJEVI KLIMA	3/8" - 3/8"	ART.9020072
	0225097	NIPEL SPOJNICA ZA CIJEVI KLIMA	1/2" - 1/2"	ART.9020073
	0225098	NIPEL SPOJNICA ZA CIJEVI KLIMA	5/8" - 5/8"	ART.9020074
	0225099	MATICE ZA NIPEL SPOJNICE ZA CIJEVI KLIME	1/4"	ART.9020061
	0225100	MATICE ZA NIPEL SPOJNICE ZA CIJEVI KLIME	3/8"	ART.9020062
	0225101	MATICE ZA NIPEL SPOJNICE ZA CIJEVI KLIME	1/2"	ART.9020063
	0225102	MATICE ZA NIPEL SPOJNICE ZA CIJEVI KLIME	5/8"	ART.9020064
	0225109	REDUCIRANI NIPEL SPOJ	3/8" - 1/2"	ART.9020102
	0225110	REDUCIRANI NIPEL SPOJ	1/2" - 5/8"	ART.9020103
	0225111	REDUCIRANI NIPEL SPOJ	3/8" - 5/8" 10 m	ART.9020106

	0225103	REDUKCIJA ZA KLIME	1/4"-3/8"	ART.9020201
	0225104	REDUKCIJA ZA KLIME	3/8" - 1/4"	ART.9020203
	0225105	REDUKCIJA ZA KLIME	3/8" - 1/2"	ART.9020204
	0225106	REDUKCIJA ZA KLIME	1/2" - 5/8"	ART.9020206
	0225107	REDUKCIJA ZA KLIME	5/8" - 1/2"	ART.9020207
	0225108	REDUKCIJA ZA KLIME	1/2" - 3/8"	ART.9020205
	0225112	BAKRENA BRTVA ZA SPOJNICE	1/4"	ART.9020051
	0225113	BAKRENA BRTVA ZA SPOJNICE	3/8"	ART.9020052
	0225114	BAKRENA BRTVA ZA SPOJNICE	1/2"	ART.9020053
	0225115	BAKRENA BRTVA ZA SPOJNICE	5/8"	ART.9020054
	0225117	MIRISNI OSVJEŽIVAČI KLIMA GREEN APPLE (SET 10 KOMADA)		ART.910501503
	0225118	MIRISNI OSVJEŽIVAČI KLIMA SWEET AROMA (SET 10 KOMADA)		ART.9910501501
	0225119	MIRISNI OSVJEŽIVAČI KLIMA VANITY HOME (SET 10 KOMADA)		ART.910501502
	0225120	MIRISNI OSVJEŽIVAČ KLIMA VANILLA (SET 10 KOMADA)		ART.910501504
	0225116	SPREJ ZA ČIŠĆENJE I DEZINFEKCIJU	400ML	ART.9105001



GLAVNE KARAKTERISTIKE:

- ▶ Otpor
- ▶ Lakoća
- ▶ Jednostavno korištenje
- ▶ Otporan na vanjske utjecaje

Nosači su certificirani prema TUV SUD-GS standardima, koji jamče:

- visoku kvalitetu materijala,
- točan dizajn i
- veću sigurnost za krajnjeg korisnika

ŠIFRAV OKEL	OPIS	DIMENZIJE (mm)	NOSIVOST (kg)	ART.
0225124	PVC POLYAMIDE NOSAČ KLIME	450 x 450	110	9794-511-08
0225125	PVC POLYAMIDE NOSAČ KLIME	520 x 450	90	9794-512-08

PREDMONTA NA KUTIJA DUPLI UNUTRAŠNJI ODVOD



VOKEL ŠIFRAB	OJAD	IMENZIJA (cm)A	RTIKAL
0225147	BIJELA	430x108x50	9899-028-01

	<p>1432001</p>	<p>PUMPA ZA VODU DAB JETINOX 102M Q=0,6-3,6 m³/h, H=47-28,8m, P1 max=1,13 Kw</p> <p>ART.102640040</p>
	<p>1432004</p>	<p>PUMPA ZA VODU DAB EUROINOX 40/80M Q=1,2-7,2 m³/h, H=58-16m, P1 max=1,48 Kw</p> <p>ART.102970360</p>
	<p>1432002</p>	<p>PUMPA ZA VODU DAB BOOSTER SILENT 4M Q=0,6-4,8 m³/h, H=43-9m, P1 max=1 Kw</p> <p>ART.60122698</p>
	<p>1432003</p>	<p>UREĐAJ ZA ODRŽAVANJE TLAKA U INSTALACIJI DAB E.SYBOX Q=120 l/min, H max= 60 m, P = 1,55 Kw</p> <p>ART.60147200</p>
	<p>1432005</p>	<p>UREĐAJ ZA ODRŽAVANJE TLAKA U INSTALACIJI DAB E.SYBOX MINI Q=80 l/min, H max= 55 m, P = 0,84 Kw</p> <p>ART.60163600</p>

Membranski regulator tlaka

Šifra Vokel	Art.	Ident	DN	PN	G	L	L1	B	H	H1	Sw		
0217048	RT 692	1421521	15	16	1/2"	147	84	67	98	66	30	0,745	6
0217049	RT 693	1431521	20	16	3/4"	155	84	67	98	66	37	0,901	6
0217050	RT 694	1441521	25	16	1"	185	98	67	98	66	46	1,185	6
0217052	RT 695		32	16	1 1/4"	147	84	67	98	66	30	0,745	6
0217053	RT 696		40	16	1 1/2"								
0217054	RT 697		50	16	2"								

T= 0,5°C...40°C

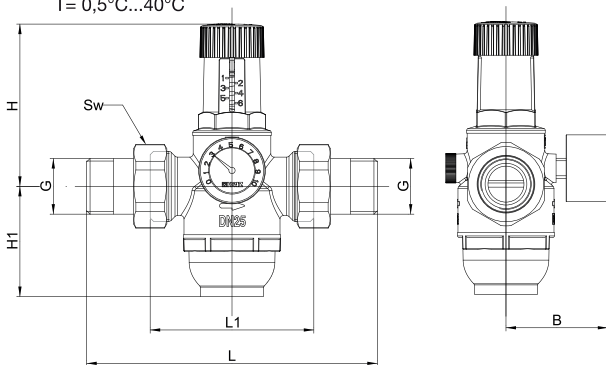

Namjena:

Membranski regulator tlaka je namijenjen za reguliranje tlaka u vodovodnim i drugim instalacijama, gdje nisu prisutni agresivni i eksplozivni mediji. Izlazni tlak može se podesiti i mijenja se s promjenama ulaznog tlaka. Izlazni tlak podeava se okretanjem zelene ručice.



* Material GRILAMID TP 90

www.vokel.com



KPI - TLAČNE SKLOPKE

Danfoss KPI tlačne sklopke koriste se za regulaciju, nadzor i sustave upozorenja u industrijskim aplikacijama.

- KPI serija pogodna je za postrojenja u kojima se koriste tekući i plinoviti mediji.
- Raspon tlaka: -0.20 do 8.00 bar
- Tip kontakata: SPDT
- Dostupno s pozlaćenim kontaktima
- Podesivi diferencijal
- Kućište IP44 kod ugradnje s gornjim pokrovom i stražnjom pločom

Š.Vokel

Opis

0683112 TLAČNA SKLOPKA 0,2-8 bar KPI35 ART.55A200-A5A

Tip	KPI35
Naziv proizvođača	DANFOSS
Težina kg	0.313 kg
Temperatura okoline [°C]	-40 – 65 °C
Raspon temperature okoline [°C]	-40 – 65 °C
Primjena s amonijakom	Ne
Funkcija kontakta	SPDT
Nazivna vrijednost kontakta	AC1=10 A, 440 V/8A, 240V
Nazivna vrijednost kontakta	AC15=4 A, 440 V
Nazivna vrijednost kontakta	AC3=6 A, 440 V
Nazivna vrijednost kontakta	DC13=12 W, 220 V
Nazivna vrijednost kontakta	LR max. 50 A
Diferencijal [bar]	0,40 – 1,50 bar
Dimenzije električnog priključka	6-14 mm
Zaštita Kućišta IP	IP30
Maksimalni ispitni tlak [bar]	18,0 bar
Maks. radni tlak [bar]	18,0 bar
Tlačni priključak	G 1/4
Standard tlačnog priključka	ISO 228-1
Priključak Muški/Ženski	Muški
Raspon tlaka	Niskotlačna
Element osjetnika tlaka	Mijeh
Proizvod	Tlačna sklopka
Regulacijsko područje [bar]	-0,20 – 8,00 bar
Reset	AUTO

Kako naručiti elektromagnetske ventile?

Za kompletan elektromagnetski ventil su potrebni:

- svitak
- kućište ventila
- priključnica



	0683109	SVITAK ZA ELEKTROMAGNETSKI VENTIL 220-230V AC ART.018F7351
	0683106 0683107 0683108	ELEKTROMAGNETSKI VENTIL EV 250B 12BD 1/2" ZA OTVORENE I ZATVORENE SUSTAVE ZA PLIN I VODU DO 60°C ART.032U5253 ELEKTROMAGNETSKI VENTIL EV 250B 18BD 3/4" ZA OTVORENE I ZATVORENE SUSTAVE ZA PLIN I VODU DO 60°C ART.032U5255 ELEKTROMAGNETSKI VENTIL EV 250B 22BD 1" ZA OTVORENE I ZATVORENE SUSTAVE ZA PLIN I VODU DO 60°C ART.032U5257
	0683110	PRIKLJUČNICA ZA VENTILE - PG 11 24V I 230V ART.042N0156

	0683113	TERMOSTAT NA DODIR (OSJETNIK TEMPERATURE PODA I PROSTORA) ART.088L0122
	0683105	SOBNI TERMOSTAT TP7001M ART.087N8003
	0683066	OGRANIČAVAČ TEMPERATURE POVRATA RAVNI FJVR 15 ART.003L1014
	0683021	ZIDNI SET ZA PODNO GRIJANJE FHV-R,OKRUGLI BIJELI POKROV ART.003L1000
	0683022	ZIDNI SET ZA PODNO GRIJANJE FHV-R,KVADRATNI BIJELI POKROV ART.003L1006
	0683023	TERMOSTATSKI OSJETNIK FJVR PODEŠAVANJE OD 10-50°C ART.003L1040
	0683024	PRODUŽETAK OD 17,9 mm ZA FJVR VENTILE ART.003L1036
	0683067	MJEŠAJUĆI SKLOP ZA PODNO GRIJANJE FHM-C5 ART.088U0084
	0683068	MJEŠAJUĆI SKLOP ZA PODNO GRIJANJE FHM-C6 ART.088U0085
	0683069	TERMOSTATSKI MJEŠAJUĆI VENTIL 30-70°, TVM-H DN 20,G 1" A ART.003Z1120
	0683070	TERMOSTATSKI MJEŠAJUĆI VENTIL 30-70°, TVM-H DN 25,G 1 1/4"A ART.003Z1127
	0683020	REGULATOR ZA SOLARNI SUSTAV SA DVA TEMPERATURNNA OSJETNIKA SH-E01 ART.088H2001

MJEŠAČ C MIX M100

- Snaga: 1.010 W/230 V
- Max. Ø mješača: 120 mm/HEXAFIX
- Opterećenje vrtnje: 630 min⁻¹

VOKEL ŠIFRA	OPIS	SNAGA (W)	ARTIKAL
0727057	MJEŠAČ C MIX M1000 (WK120HF)	1010	20360

MJEŠAČ C MIX M1400

- Snaga: 1.400 W/230 V
- Max. Ø mješača: 140 mm/HEXAFIX
- Opterećenje vrtnje: 400/620 min⁻¹

VOKEL ŠIFRA	OPIS	SNAGA (W)	ARTIKAL
0727058	MJEŠAČ C MIX M1400 (WK140HF)	1400	20370

MJEŠAČ X01 M

- Snaga: 1.010 W/230 V
- Max. Ø mješača: 120 mm/HEXAFIX
- Opterećenje vrtnje: 630 min⁻¹

VOKEL ŠIFRA	OPIS	SNAGA (W)	ARTIKAL
0727067	MJEŠAČ X01 M (WK 120M)	1010	20406

HEXAFIX
ADAPTER

VOKEL ŠIFRA	OPIS	ARTIKAL
0727059	ADAPTER HEXAFIX (BRZA SPOJKA)	49517-000



WK

MJEŠALO

VOKEL ŠIFRA	OPIS	ARTIKAL
0727060	MJEŠALO WK120HF	40112-000
0727061	MJEŠALO WK140HF	40113-000



KR

MJEŠALO

VOKEL ŠIFRA	OPIS	ARTIKAL
0727062	MJEŠALO KR120HF	40120-000
0727063	MJEŠALO KR140HF	40121-000



MK

MJEŠALO

VOKEL ŠIFRA	OPIS	ARTIKAL
0727064	MJEŠALO MK120HF	40114-000
0727065	MJEŠALO MK140HF	40115-000



FM

MJEŠALO

VOKEL ŠIFRA	OPIS	ARTIKAL
0727066	MJEŠALO FM120HF	40102-000

LAJSNA KUTNA PVC L=270 cm

23042	BEŽ	RE/8/100	ART.80151/100
23054	PASTELNO PLAVA	RE/8/100	ART.80141/100
23244	TAMNO SIVA	RE/8/100	ART.80117/100
23041	PEPELASTO SIVA	RE/8/100	ART.80121/100
23328	SVIJETLO SIVA	RE/8/100	ART.80125/100
23039	BIJELA	RE/8/100	ART.80101/100
23104	CRNA	RE/8/100	ART.80133/100
23083	SMEĐA	RE/8/100	ART.80169/100
23338	TAMNO SMEĐA	RE/8/100	ART.80173/100
23279	ROZA	RE/8/100	ART.80145/100
23280	CARAMEL	RE/8/100	ART.80165/100
23281	JASMIN	RE/8/100	ART.80109/100
23290	ŽUTA	RE/8/100	ART.80137/100
23295	CRVENA	RE/8/100	ART.80129/100
23300	PLAVA-MODRA	RE/8/100	ART.80161/100
23322	KREM	RE/8/100	ART.80105/100
23334	BRESKVA	RE/8/100	ART.80155/100



ČEP ZA PVC LAJSNE

23110	BIJELI	TE/8/50	ART.80401
23111	SVIJETLO SIVA	TE/8/50	ART.80421
23112	BEŽ	TE/8/50	ART.80449
23136	PASTELNO PLAVI	TE/8/50	ART.80441
23140	CRNI	TE/8/50	ART.80433
23297	CARAMELLO	TE/8/50	ART.80459
23298	MARRON	TE/8/50	ART.80463
23291	CRVENI	TE/8/50	ART.80429
23292	ŽUTI	TE/8/50	ART.80437
23293	ROZI	TE/8/50	ART.80445
23294	JASMIN	TE/8/50	ART.80409
0994272	BRESKVA	TE/8/50	ART.80453
0994273	SMEĐI	TE/8/50	ART.80467
23179	BIJELI	TE/10/50	ART.80402
23180	SVIJETLO SIVI	TE/10/50	ART.80422
23181	BEŽ	TE/10/50	ART.80450
0994268	JASMIN	TE/10/50	ART.80410
23266	BIJELI	TE/12/50	ART.80403
0994362	MAT-BAKAR	TBRS/10	ART.92770

0994269	CRNA	RE/10/100	ART.80134/100
23175	BIJELA	RE/10/100	ART.80102/100
23245	TAMNO SIVA	RE/10/100	ART.80118/100
23176	PEPELASTO SIVA	RE/10/100	ART.80122/100
23329	SVIJETLO SIVA	RE/10/100	ART.80126/100
23177	BEŽ	RE/10/100	ART.80152/100
23323	KREM	RE/10/100	ART.80106/100
23324	JASMIN	RE/10/100	ART.80110/100
23330	CRVENA	RE/10/100	ART.80130/100
23335	BRESKVA	RE/10/100	ART.80156/100
23336	CARAMEL	RE/10/100	ART.80166/100
23339	TAMNO SMEĐA	RE/10/100	ART.80174/100
23212	BIJELA	RE/12/100	ART.80103/100

LAJSNA KUTNA ALUMINIJ L=270 cm

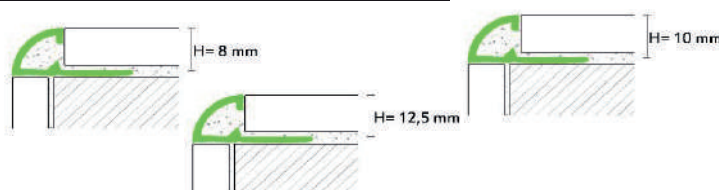
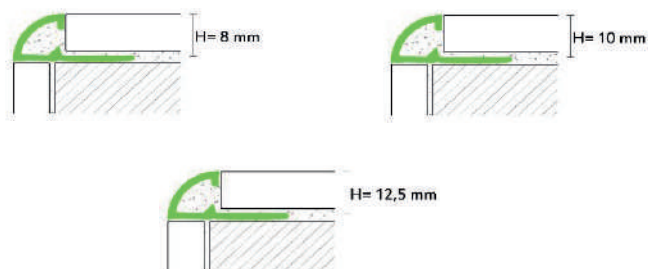
23022	ALUMINIJ-BIJELA	RV/8	ART.92102
23037	KROMIRANA	RB/8	ART.92312
23036	ZLATNA	RB/8	ART.92342
23216	KROMIRANA	RB/10	ART.92314
23265	ALUMINIJ ZLATNA	RB/10	ART.92344
23282	KROM MATIRANA	RA/8	ART.92072
0994216	KROM MATIRANA	RA/10	ART.92076
23275	ALUMINIJ- MAT	RA/10	ART.92074
0994361	MAT-BAKAR	RBRS/10	ART.92306



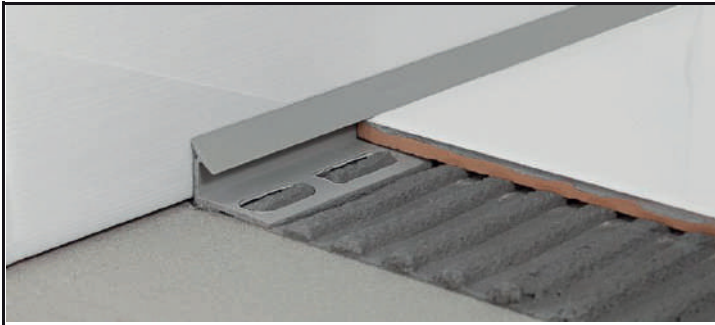

LAJSNA UNUTARNJI KUT PVC L=270 cm

23130	BIJELA	PI/9	ART.95402
23132	BEŽ	PI/9	ART.95410
23173	SIVA	PI/9	ART.95414

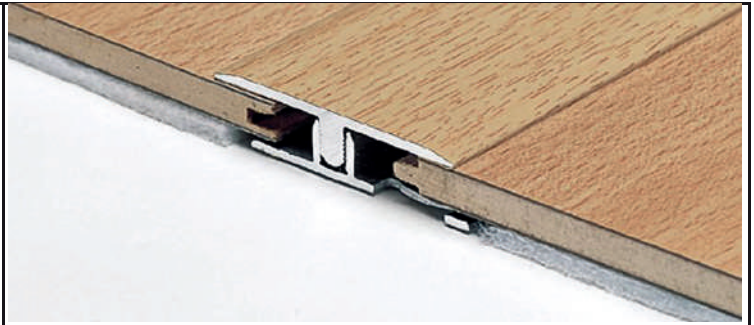
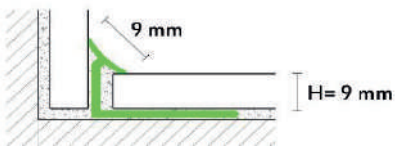

T-LAJNSNA ALUMINIJ L=270 cm

23099	ZLATNA	Z/1/SF	ART.67227
23100	SREBRNA	Z/1/SF	ART.67217

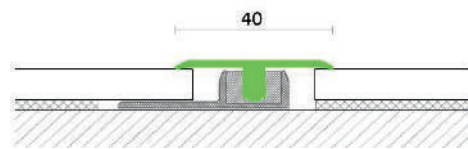

T-LAJNSNA MESING L=270 mm

23043	MESING 14 mm	399/T	ART.75087
23215	KROMIRANA 14 mm	399/TC	ART.75086
23105	MESING 26 mm	399/T26	ART.75088
23134	KROMIRANA 26 mm	399/T26C	ART.75089
0994256	MESING 14 mm L=90 cm	4399/T	ART.20016
0994257	ALUMINIJ 14 mm L=90 cm	499/T	ART.20008

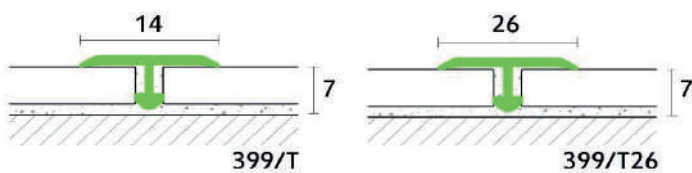

TE-LAJNSNA BOJA DRVETA L=270 cm

23277	BOJA DRVETA BR.40	Z2/20/SF	ART.63630
--------------	-------------------	----------	-----------

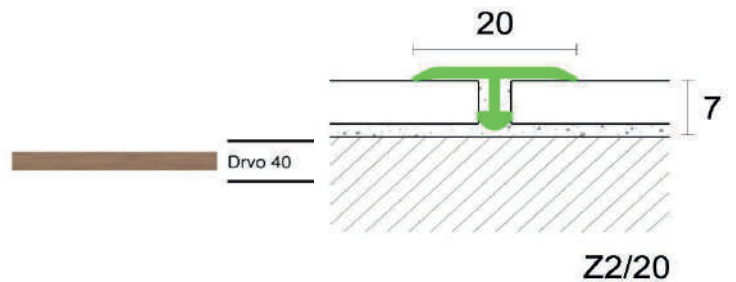

TE-LAJNSNA BOJA DRVETA L=270 cm

23278	BOJA DRVETA BR.50	Z3/30/SF	ART.63740
--------------	-------------------	----------	-----------

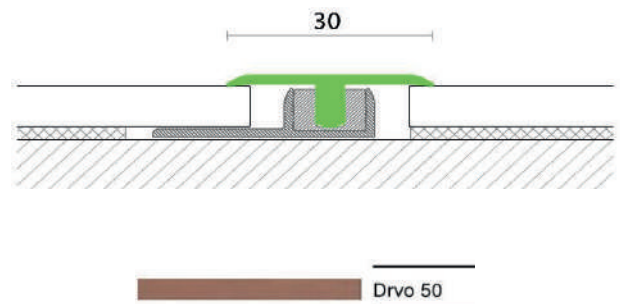



TE-LAJNSNA INOX L=270 cm

- | | | | |
|----------------|-----------------------|---------|-----------|
| 23276 | ČELIK INOX 26 mm | 799/T26 | ART.75096 |
| 0994253 | ČELIK INOX 14 mm L=90 | 4799/T | ART.20001 |



LAJNSNA ZA RAZDVAJANJE I DEKORACIJU L=270 cm

- | | | | |
|----------------|---------------------|-------|-----------|
| 0994221 | ČELIK INOX 10x10 mm | 799/U | ART.75078 |
|----------------|---------------------|-------|-----------|

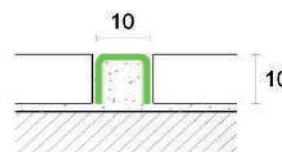

LAJNSNA ZA RAZDVAJANJE L=270 cm

- | | | | |
|----------------|-----------------|---------|-----------|
| 0994254 | ČELIČNA H=8 mm | AIS/80 | ART.91674 |
| 0994255 | ČELIČNA H=10 mm | AIS/100 | ART.91675 |

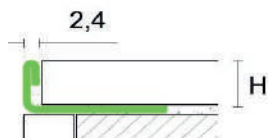

LAJNSNA ZA RAZDVAJANJE-SAVITLJIVA L=270 cm

- | | | | |
|----------------|---------------------|---------|-----------|
| 0994258 | ALUMINIJSKA H=8 mm | ZGF/80 | ART.88723 |
| 0994259 | ALUMINIJSKA H=10 mm | ZGF/100 | ART.88724 |

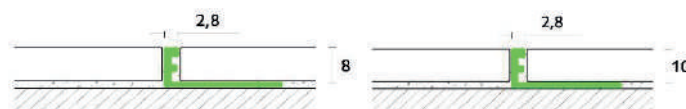

LAJNSNA ZA RAZDVAJANJE L=270 cm

- | | | | |
|--------------|------------------|--------|-----------|
| 23102 | MESING H=8 mm | DN/80 | ART.91620 |
| 23145 | MESING H=10 mm | DN/100 | ART.91622 |
| 23103 | MESING H=12,5 mm | DN/125 | ART.95624 |

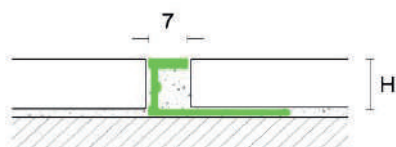

LAJNSNA ZA STEPENICE L=270 cm

- | | | | |
|--------------|------------------|--------|-----------|
| 23107 | MESING H=8 mm | SN/80 | ART.93991 |
| 23178 | MESING H=10 mm | SN/100 | ART.93922 |
| 23139 | MESING H=12,5 mm | SN/125 | ART.93993 |

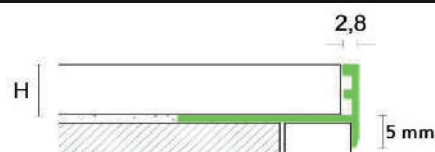

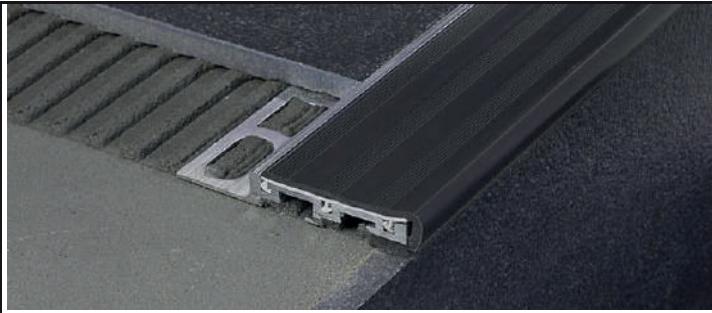

LAJSNA ZA STEPENICE SA CRNOM GUMOM L=270 cm

- | | | | |
|--------------|-----------|----------|-----------|
| 23092 | H=10 mm | SA/100/2 | ART.94081 |
| 23135 | H=12,5 mm | SA/125/2 | ART.94141 |



LAJSNA KUTNA PLASTIČNA L= 270 cm

- | | | | |
|--------------|----------------------|---------|-----------|
| 23146 | BIJELA SAMOLJEPLJIVA | BP/20/A | ART.95470 |
| 23147 | BIJELA | BP20 | ART.95490 |

LAJSNA ZA STEPENICE SA TAMNO SIVOM GUMOM L=270 cm

- | | | | |
|----------------|--------|---------|-----------|
| 0994227 | H=8 mm | SA/80/3 | ART.94041 |
|----------------|--------|---------|-----------|

LAJSNA KUTNA ALUMINIJSKA L= 270 cm

- | | | | |
|--------------|----------------------|--------|-----------|
| 23214 | BIJELA SAMOLJEPLJIVA | B/20/A | ART.95460 |
| 23213 | BIJELA | B/20 | ART.95459 |

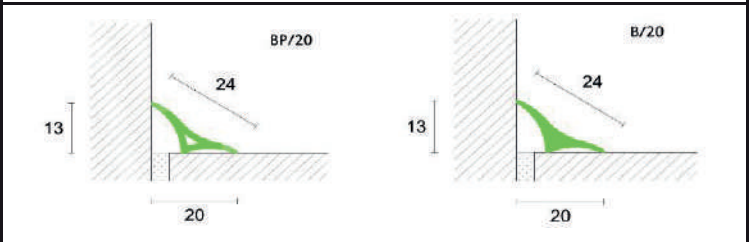
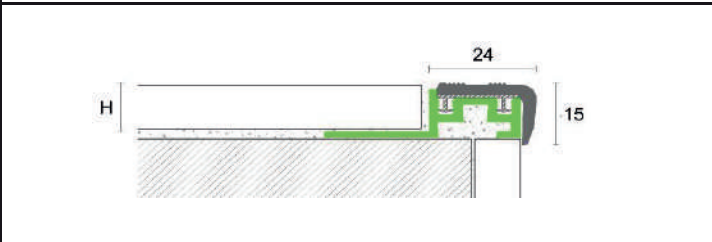

PVC KUTNA LAJSNA ZA KADE L=270 cm

- | | | | |
|--------------|--------|-------|-----------|
| 23285 | BIJELA | BP/25 | ART.95540 |
|--------------|--------|-------|-----------|



PVC KUTNA LAJSNA ZA KADE L=270 cm

- | | | | |
|--------------|--------|-------|-----------|
| 23283 | BIJELA | BP/22 | ART.95520 |
|--------------|--------|-------|-----------|

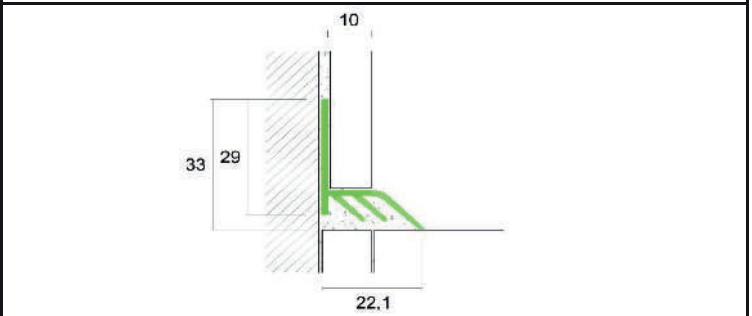
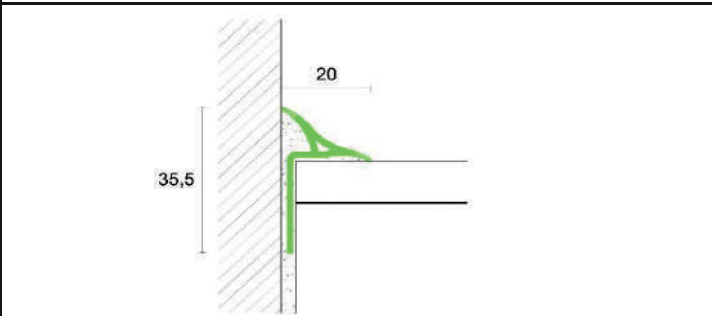



ALUMINIJSKA LAJSNA PLOSNATA L=270 cm

23067	ALUMINIJ-ZLATNA	27/ST	ART.69014
23066	ALUMINIJ-SREBRNA	27/ST	ART.69006
23069	BOJA DRVETA 40	27/ST	ART.70024



ALUMINIJSKA LAJSNA PLOSNATA L=270 cm

0994242	ZLATNA 93 cm	427/CT	ART.41008
0994243	BOJA DRVETA 20 93 cm	427/CT	ART.45357
0994244	BOJA DRVETA 40 93 cm	427/CT	ART.45367

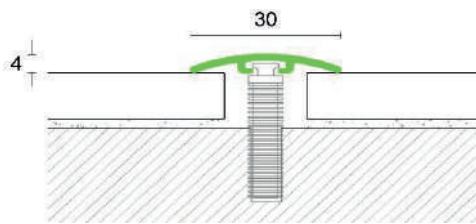
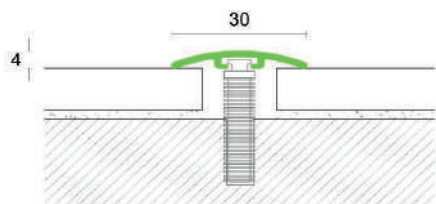

ALUMINIJSKA LAJSNA ZA RAZLIČITE VISINE L=270 cm

23116	BOJA DRVETA 40	28/ST	ART.70282
23113	ZLATNA	28/ST	ART.69254
0994237	SREBRENA 40 mm	29/ST	ART.69142
0994238	ZLATNA 40 mm	29/ST	ART.69150
0994239	BOJA DRVETA 40 40 mm	29/ST	ART.70136
0994245	SREBRENA L=93 cm	429/CT	ART.41202
0994246	ZLATNA L=93 cm	429/CT	ART.41208

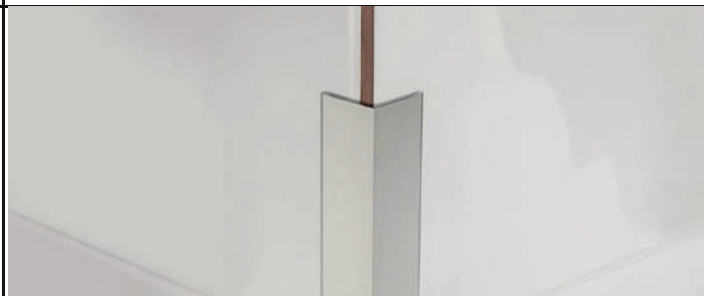

LAJSNA KUTNA 20x20 L=270 cm

23073	MESING-SJAJNA	077/SF	ART.76728
23074	ČELIK INOX	777/SF	ART.76898

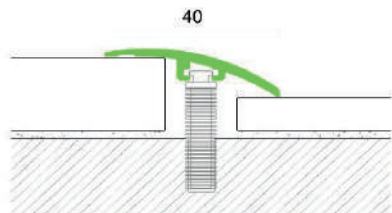
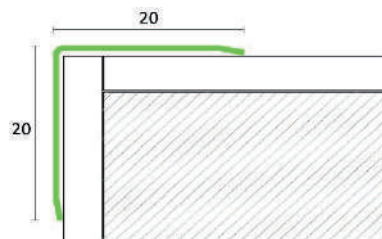



ALUMINIJSKA LAJSNA DEKORATIVNA L=270 cm

0994217	ALUMINIJ KROM 10 mm LA/B	ART.93252
0994332	ALUMINIJ ZLATO 10 mm LA/B	ART.93253
0994218	ALUMINIJ KROM 25 mm LB/B	ART.93272

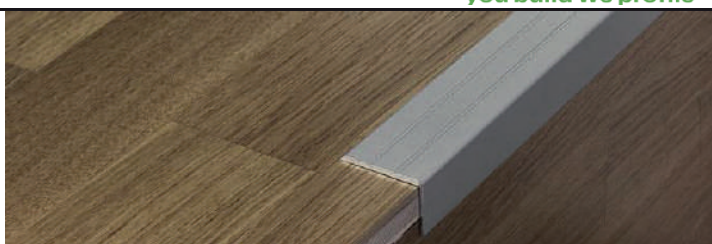

SAMOLJEPLJIVA ALUMINIJSKA LAJSNA ZA STEPENICE-PLOSNATA L=270 cm

0994251	ZLATNA	74/A	ART.95298
0994252	BRONZA	74/A	ART.95318

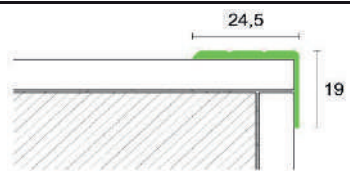
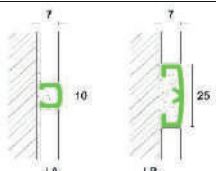

ALUMINIJSKA LAJSNA ZA STEPENICE L=270 cm

0994212	SREBRENA	73/F	ART.75208
0994213	ZLATNA	73/F	ART.75218
0994215	ZLATNA	53/SF	ART.75204

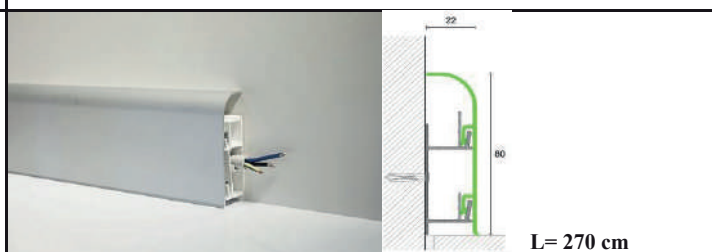

0994231	ALU.COKLO S 3 NOSAČA	97/8SF	ART.78010
0994232	VANJSKI KUT	97/8E	ART.78210
0994233	UNUTARNJI KUT	97/8I	ART.78211
0994234	RAVNI PVC SPOJ	97/8G	ART.78212
0994235	ČEPOVI PVC	97/8P	ART.78213

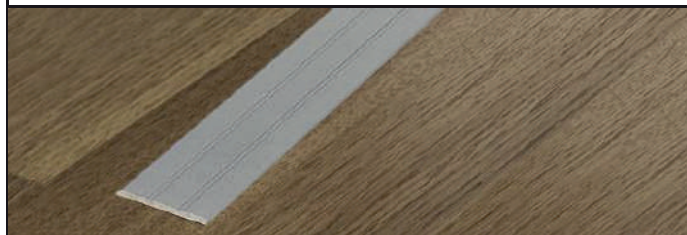
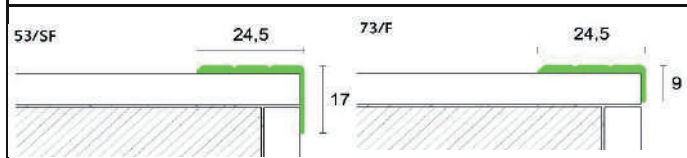

SAMOLJEPIVA ALUMINIJSKA LAJSNA ZA SPOJEVE-PLOSNATA L=270 cm

0994249	SREBRENA	19/A	ART.71897
0994250	ZLATNA	19/A	ART.71907



LAJSNA ZA FUGE L=270 cm

23048	MESING H=10 mm	399/R10	ART.75007
23070	MESING 7 mm	380/7	ART.75037

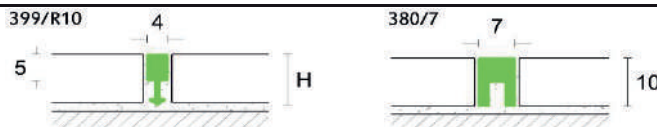



PROTUKLIZNA TRAKA ZA STEPENICE 19 mm L=18,2 m

23031	CRNA	ART.23002
23033	SMEĐA	ART.23062
23272	PROZIRNA	ART.23018



LAJSNA ZA DILATACIJU L=270 cm

0994260	SIVO-SIVO H= 8 mm	NL/80	ART.99700
23174	SIVO-SIVO H= 10 mm	NL/100	ART.99710
0994276	SIVO-SIVO H= 12,5 mm	NL/125	ART.99720

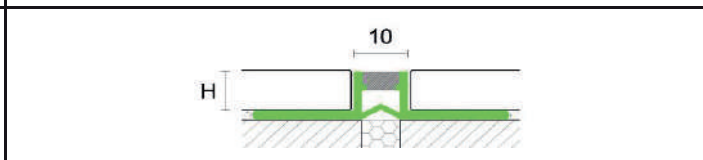
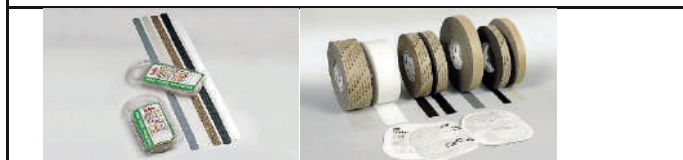

PODLOŽNA LAJSNA L=270 cm

23101	ALUMINIJ	T/7/F	ART.67287
--------------	----------	-------	-----------

Od 6,5mm do 9,5 mm

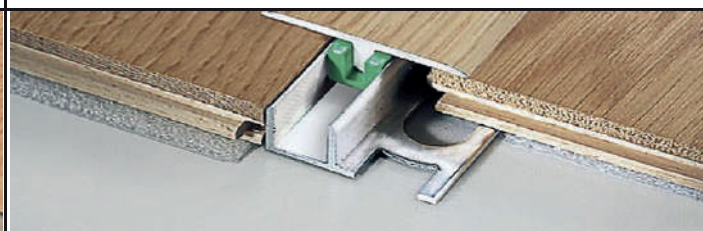

PODLOŽNA ALUMINIJSKA LAJSNA ZA STEPENICE L=270 cm

0994405	ALUMINIJ SREBRENA	TPU/6	ART.67437
23220	ALUMINIJ SREBRENA	TPU/10	ART.67447



Unisystem Plus baza uključuje 15 umetaka TU/7



ALUMINIJSKA LAJSNA ZA STEPENICE L=270 cm

23217	ALUMINIJ SREBRENA	G/4/SF	ART.63900
23218	ALU.BOJA DRVETA 10	G/4/SF	ART.63910
0994230	ALU.BOJA DRVETA 20	G/4/SF	ART.63915
23219	ALU.BOJA DRVETA 40	G/4/SF	ART.63920
0994229	PJEŠČANO ZLATNA	G/4/SF	ART.63904



ALUMINIJSKA LAJSNA ZA LAMINAT-ZAVRŠNA L=270 cm

0994208	ZLATNA	RC/7	ART.67417
0994209	SREBRENA	RC/7	ART.67407
0994210	ALU.BOJA DRVETA 40	RC/7	ART.66710
0994211	ALU.BOJA DRVETA 60	RC/7	ART.66716
0994406	ANODIZIRANO SREBRO	RC/9/F	ART.67477
0994407	ANODIZIRANO SREBRO	RC/11/F	ART.67547

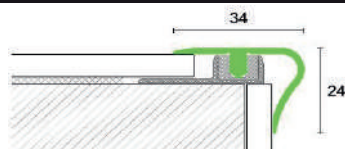

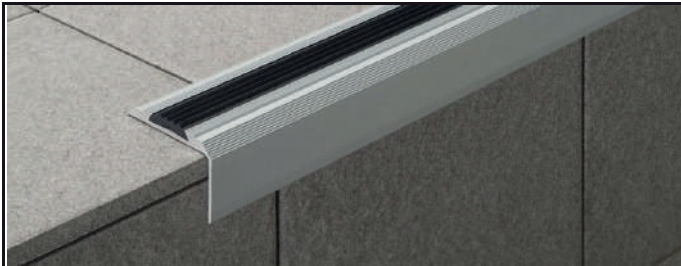

Lajsna za stepenice L=340 cm

23058	ALUMINIJ SREBRENA	72/F	ART.75508
23057	ALUMINIJ ZLATNA	72/F	ART.75518
23059	GUMA ZA LAJSNE SMEĐA GM/72		ART.75569

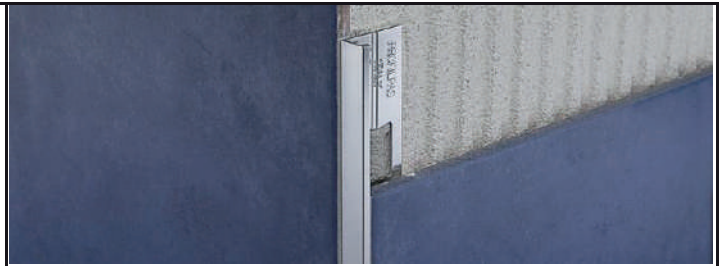

Kutna aluminijaska lajsna L=270 cm

0994219	SREBRENA H= 8 mm	ZA/80	ART.88205
0994220	SREBRENA H= 10 mm	ZA/100	ART.88206

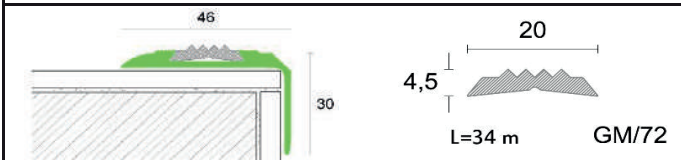

ALUMINIJSKA LAJSNA ZA BALKONE I TERASE L=270 cm

0994294	LAJSNA OBODNA H=12	CPHA/125	ART.87601
----------------	--------------------	----------	-----------



KAJLE ZA KERAMIKU

23060	KAJLE ZA KERAMIKU 1-5 mm 250/1 L=9mm H=5mm	CN28	ART.19080
--------------	--	------	-----------

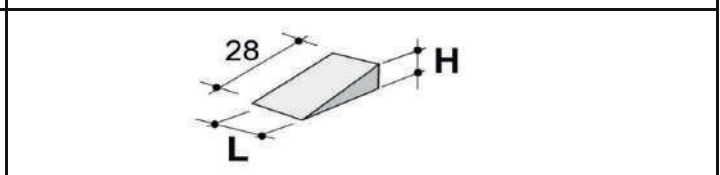
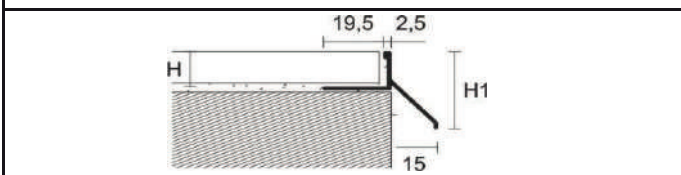

KRIŽIĆI ZA POSTAVLJANJE KERAMIKE

0994282	KRIŽIĆI PUNI 1 mm 500/1		ART.18992
23108	KRIŽIĆI PUNI 2mm 500/1		ART.19002
23001	KRIŽIĆI PUNI 2mm 250/1		ART.19000
23097	KRIŽIĆI ŠUPLJI 3mm 500/1		ART.19008
12980	KRIŽIĆI PUNI 4mm 250/1		ART.18006
23098	KRIŽIĆI ŠUPLJI 5mm 500/1		ART.19020
11176	KRIŽIĆI ŠUPLJI 7mm 1000/1		ART.19026
0994279	KRIŽIĆI ŠUPLJI 10 mm 500/1		ART.19032



T - KRIŽIĆI ZA POSTAVLJANJE KERAMIKE

23248	T-KRIŽIĆI 2 mm 250/1		ART.19040
0994278	T-KRIŽIĆI 2 mm 500/1		ART.19042
23249	T-KRIŽIĆI 3 mm 250/1		ART.19046
23250	T-KRIŽIĆI 5 mm 250/1		ART.19058

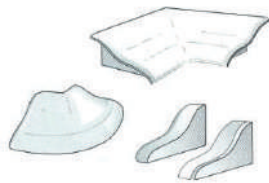

ČEPOVI ZA KUTNE LAJSNE

23148	SET ČEPOVA	BPT/20	ART.95480
23284	SET ČEPOVA	BPT/22	ART.95530
23286	SET ČEPOVA	BPT/25	ART.95545



ČEPOVI ZA LAJSNE

0994295	ČEP ZA LAJSNE ALU-MAT TA/8	ART.92608
0994280	ČEP ZA LAJSNE ALU-MAT TA/10	ART.92610
0994281	ČEP ZA LAJSNE ALU-MAT TA/12	ART.92612
23143	ČEP ZA LAJSNE KROM TB/8/50	ART.92692
23340	ČEP ZA LAJSNE ZLATNI TB/8/50	ART.92702
23341	ČEP ZA LAJSNE KROM TB/10/50	ART.92694
23342	ČEP ZA LAJSNE ZLATNI TB/10/50	ART.92704

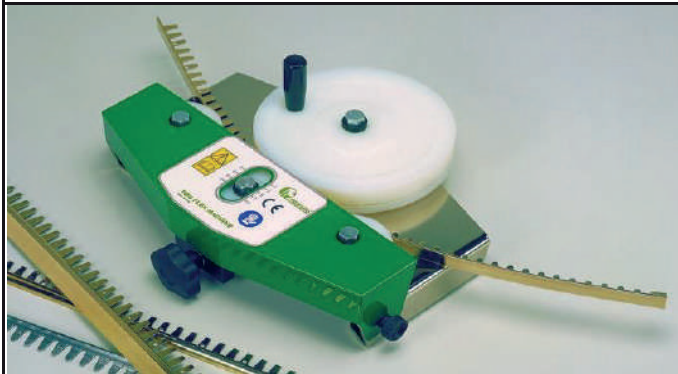

STROJ ZA SAVIJANJE LAJSNI

23138	STROJ ZA SAVIJANJE LAJSNI	ART.30022
--------------	---------------------------	-----------



PVC VIJCI ZA LAJSNE

23114	VIJAK 29 mm	T/29/200	ART.68900
23115	VIJAK 29 mm	T/38/100	ART.68901

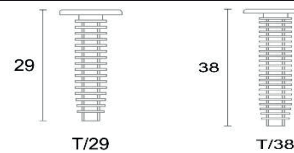



TE-LAJSNA L=270 cm

- | | | | |
|----------------|------------------|--------|-----------|
| 0994222 | ALUMINIJ L=14 mm | 99/T | ART.75080 |
| 0994223 | ALUMINIJ L=26 mm | 99/T26 | ART.75082 |

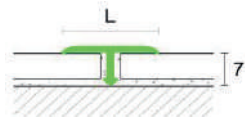

LAJSNA ZA STEPENICE L=270 cm

- | | | | |
|--------------|--------|---------|-----------|
| 23223 | MESING | SGL/110 | ART.94977 |
|--------------|--------|---------|-----------|

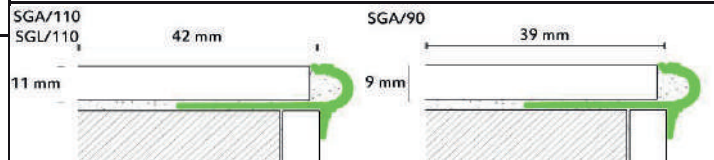

LAJSNA KUTNA PVC L=270 cm

- | | | | |
|----------------|-----------------|------------|-----------|
| 0994284 | BIJELA | ZQP/100/10 | ART.80802 |
| 0994285 | SVIJETLO SIVA | ZQP/100/10 | ART.80822 |
| 0994286 | KAMENO SIVA | ZQP/100/10 | ART.80818 |
| 0994287 | ANTRACITE | ZQP/100/10 | ART.80826 |
| 0994288 | BOJA BJELOKOSTI | ZQP/100/10 | ART.80810 |
| 0994289 | PR LJAVO BIJELA | ZQP/100/10 | ART.80806 |
| 0994290 | BEŽ | ZQP/100/10 | ART.80834 |
| 0994291 | BEŽ SIVO | ZQP/100/10 | ART.80814 |
| 0994292 | PASTELNO PLAVA | ZQP/100/10 | ART.80830 |

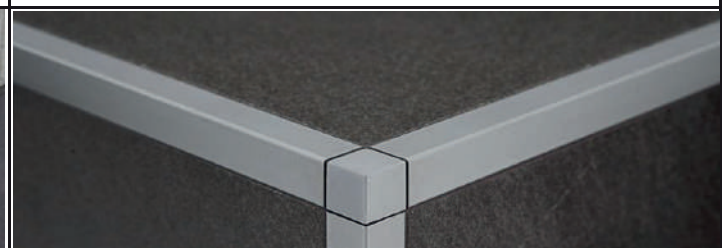

ČEP ZA PVC LAJSNE

- | | | | |
|----------------|-----------------|------------|-----------|
| 0994296 | BIJELA | ZQP/100/50 | ART.80852 |
| 0994297 | CREMA | ZQP/100/50 | ART.80856 |
| 0994298 | BOJA BJELOKOSTI | ZQP/100/50 | ART.80860 |
| 0994299 | BEŽ | ZQP/100/50 | ART.80864 |
| 0994300 | KAMENO SIVA | ZQP/100/50 | ART.80868 |
| 0994301 | SVIJETLO SIVA | ZQP/100/50 | ART.80872 |
| 0994302 | ANTRACITE | ZQP/100/50 | ART.80876 |
| 0994303 | PASTELNO PLAVA | ZQP/100/50 | ART.80880 |
| 0994304 | BEŽ SIVO | ZQP/100/50 | ART.80884 |



INOX LAJSNA ZA UNUTARNJU STRANU TUŠA L=148 cm

- | | | | |
|----------------|----------------|------------|-----------|
| 0994411 | INOX LAJSNA SX | GPS3/SX/10 | ART.31677 |
| 0994410 | INOX LAJSNA DX | GPS3/DX/10 | ART.31675 |

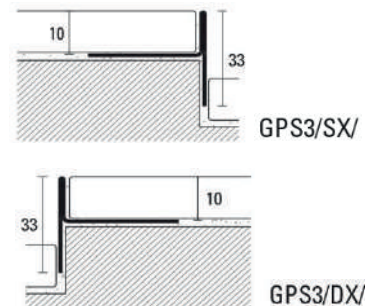



LAJSNA KUTNA ALUMINIJSKA ČETVRTASTA L=270 cm

0994345	PLATINUM	ZQAND/10	ART.31112
0994346	TITANIUM	ZQAND/10	ART.31122
0994347	SMEĐA	ZQAND/10	ART.31132
0994348	ELOKS.SREBRO	ZQAN/10	ART.88878
0994349	ELOKS.SREBRO	ZQAN/12,5	ART.88880
0994350	SJAJ.SREBRO	ZQBN/10	ART.88922
0994351	SJAJ.SREBRO	ZQBN/12,5	ART.88924
0994352	IZBRAZD.SREBRO	ZQAGN/10	ART.89065

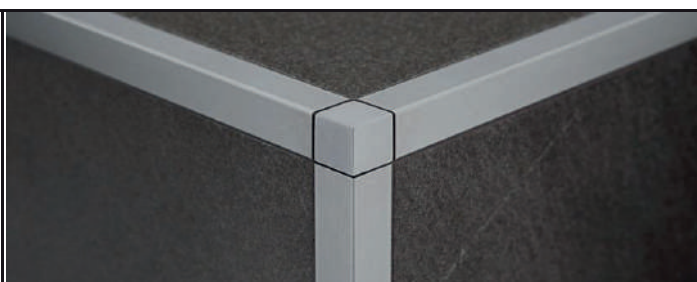
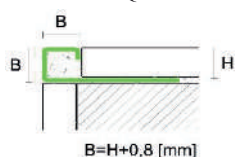

ČEP ZA ALUMINIJSKE LAJSNE ČETVRTASTI

0994353	PLATINUM	ZQAND/10/EI	ART.31162
0994354	SMEĐI	ZQAND/10/EI	ART.31182
0994355	TAMNO SMEĐI	ZQAND/10/EI	ART.31192
0994356	ELOKS.SREBRO	ZQAN/10/EI	ART.88885
0994357	ELOKS.SREBRO	ZQAN/12,5/EI	ART.88887
0994358	SJAJ.SREBRO	ZQBN/10/EI	ART.88929
0994359	SJAJ.SREBRO	ZQBN/12,5/EI	ART.88931
0994360	IZBRAZD.SREBRO	ZQAGN/10/EI	ART.89073



LAJSNA KUTNA ALUMINIJSKA ZAOBLJENA L=270 cm

0994361	MAT -BAKRENA	RBRS/10	ART.92306
----------------	--------------	---------	-----------



ČEP ZA ALUMINIJSKE LAJSNE ZAOBLJENI

0994362	MAT -BAKRENI	TBRS/10	ART.92770
----------------	--------------	---------	-----------



DEKORATIVNA LAJSNA ALUMINIJSKA 25x7 cm L=270 cm

0994363	PLATINUM	LDAD	ART.31320
0994364	SMEĐA	LDAD	ART.31324
0994365	TAMNO SMEĐA	LDAD	ART.31326



DEKORATIVNA LAJSNA ALUMINIJSKA 20x7 cm L=270 cm

0994366	IZBRAZDANA SREBRNA	LDAG/20x7	ART.93228
----------------	--------------------	-----------	-----------

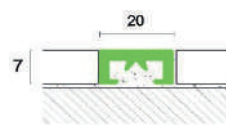



TE-LAJNSNA 14 mm L=270 cm

0994222 ANODIZIRANO 99/T/14 ART.75080
SREBRO

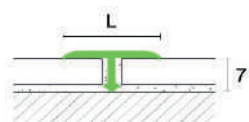

LAJSNA ZA RAZLIČITE VISINE L= 270 cm

0994368 ANODIZIRANO PBA/12,5 ART.93208
SREBRO

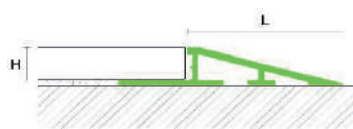

LAJSNA ZA STEPENICE L=270 cm

0994032 ANODIZIRANO SGA/11 ART.94967
SREBRO

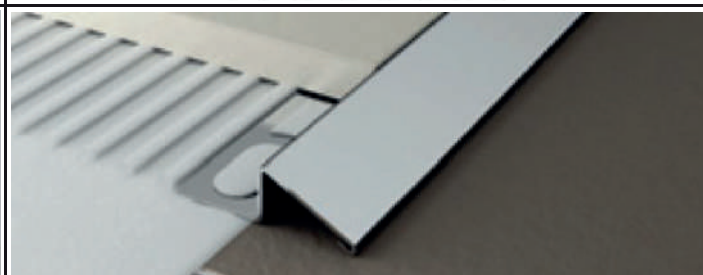
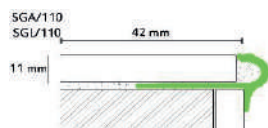

PRELAZNA LAJSNA ZA RAZLIČITE VISINE L= 270 cm

0994344 ALUMINIJSKA h=8 mm PA/8 ART.93181
0994342 ALUMINIJSKA h=10 mm PA/10 ART.93182
0994343 ALUMINIJSKA h=12 mm PA/12 ART.93183



ALUMINIJSKO COKLO 60 mm L=270 cm

0994367 ANODIZIRANO 90/6 SF ART.78100
SREBRO

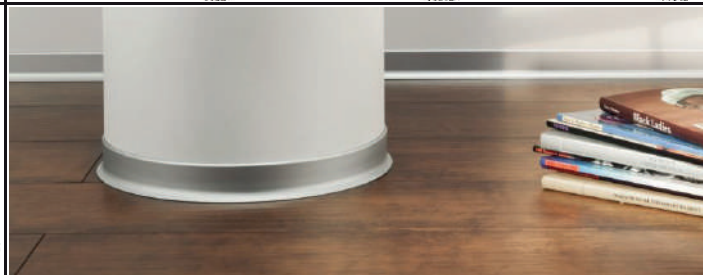
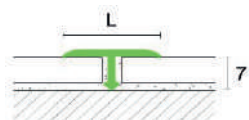

0994370 UNUTARNJI KUT 6 cm 90/6 I ART.78190
0994369 VANJSKI KUT 6 cm 90/6 E ART.78191
0994371 SPOJNICA 6 cm 90/6 G ART.78192
0994372 ČEP 6 cm 90/6 P ART.78193



TUŠ KANALICA 60 cm BAZA + REŠETKA RAVNA
0994373 NEHRĐAJUĆI ČELIK DIN.1.4301 SLIM/60 cm ART.19504



REŠETKA ZA TUŠ KANALICU 60 cm
0994374 INOX SATINIRANI XSC/60 ART.19524
0994375 INOX GLATKI XSC/60 ART.19523

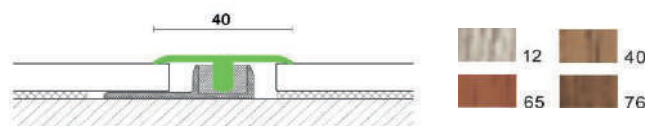

T-LAJSNA ALUMINIJ 40 mm L=270 cm

23099	ZLATNA	Z/1/SF	ART.67227
23100	SREBRNA	Z/1/SF	ART.67217
0994376	BOJA DRVETA 12	Z/1/SF	ART.66309
0994377	BOJA DRVETA 40	Z/1/SF	ART.66337
0994378	BOJA DRVETA 65	Z/1/SF	ART.66365
0994379	BOJA DRVETA 76	Z/1/SF	ART.66374

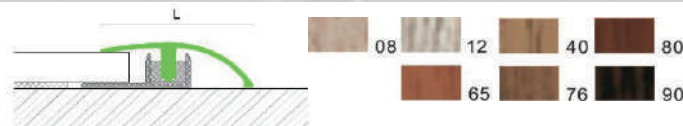

T-LAJSNA ZA RAZLIČITE VISINE ALUMINIJ 40 mm L=270 cm

0994380	ZLATNA	C/7/SF	ART.67017
0994381	SREBRNA	C/7/SF	ART.67007
0994382	BOJA DRVETA 12	C/7/SF	ART.66009
0994383	BOJA DRVETA 40	C/7/SF	ART.66037
0994384	BOJA DRVETA 65	C/7/SF	ART.66065
0994385	BOJA DRVETA 76	C/7/SF	ART.66074
0994386	BOJA DRVETA 80	C/7/SF	ART.66077
0994387	BOJA DRVETA 90	C/7/SF	ART.66087



ZAVRŠNA LAJSNA ALUMINIJ 32 mm L=270 cm
0994392 SREBRNA S/9/SF ART.65680

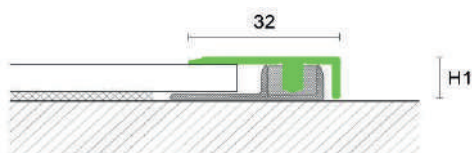

T-LAJSNA ZA RAZLIČITE VISINE ALUMINIJ 45 mm L=270 cm

0994388	BOJA DRVETA 08	C/10/SF	ART.66104
0994389	BOJA DRVETA 40	C/10/SF	ART.66137
0994390	BOJA DRVETA 65	C/10/SF	ART.66165
0994391	BOJA DRVETA 76	C/10/SF	ART.66182

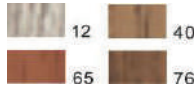

PVC COKLO 70 mm L=250 cm

0994393	BIJELA	8608	ART.29070
0994394	BOJA DRVETA 12	8608	ART.29045
0994395	BOJA DRVETA 40	8608	ART.29051
0994396	BOJA DRVETA 76	8608	ART.29060

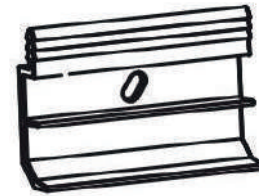

PROFIL ZA MONTAŽU COKLA NA ZID

0994397	PROFIL	8608/C	ART.29751
----------------	--------	--------	-----------



ZAVRŠNA LAJSNA ALUMINIJ 21 mm L=270 cm

0994398	ANODIZIRANO SREBRO	Z/4	ART.85050
----------------	--------------------	-----	-----------

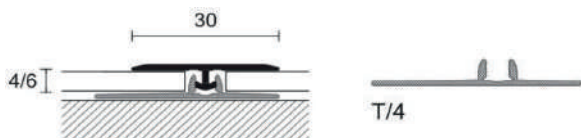

T-LAJNSNA ALUMINIJ L=270 cm

0994399	ANODIZIRANO SREBRO	C/4	ART.85060
----------------	--------------------	-----	-----------

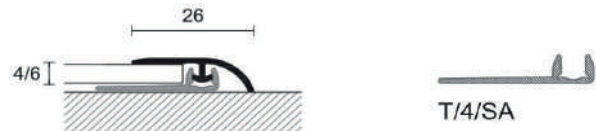

ALUMINIJSKA LAJSNA ZA RAZLIČITE VISINE L=270 cm

0994400	ANODIZIRANO SREBRO	C/4	ART.85070
----------------	--------------------	-----	-----------



PODLOŽNE LAJSNE L=270 cm

0994401	ALUMINIJ	T/4	ART.85080
0994402	ALUMINIJ	T/4/SA	ART.85082
0994408	PVC ZELENA	PT/4	ART.85081
0994409	PVC ZELENA	PT/4/SA	ART.85083

SERIJA 1.

- Alumijski profili za zaštitu vanjskih kutova zidnih obloga.
- Preporučuje se upotreba u vrlo prolaznim prostorima, ili gdje postoji opasnost da se prilikom prolaženja oštete rubovi obloge.
- Dostupne su u tri boje: zlatna, srebrna, bronca i antracit.

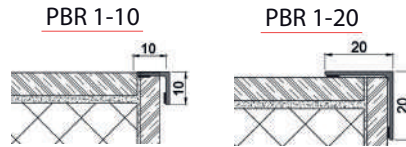

VOKEL ŠIFRA	OPIS	BOJA	DIMENZIJA (m)	ARTIKAL
1330058	PBR ALUMINIJSKA LAJSNA PBR 1-10	SREBRENA	2,70	121008
1330076	PBR ALUMINIJSKA LAJSNA PBR 1-10	ANTRACIT	2,70	121062
1330028	PBR ALUMINIJSKA LAJSNA PBR 1-20	SREBRENA	2,70	121011
1330068	PBR ALUMINIJSKA LAJSNA PBR 1-20	BRONČANA	2,70	121010
1330077	PBR ALUMINIJSKA LAJSNA PBR 1-20	ANTRACIT	2,70	121069

SERIJA 2.

- Alumijski profili za dilataciju i zaštitu vanjskih kutova.
- Dostupne su u pet boja: zlatna, srebrna, bronca, bijela i antracit

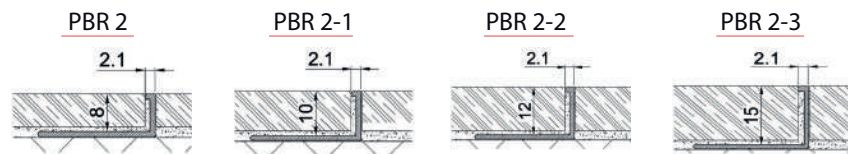

VOKEL ŠIFRA	OPIS	BOJA	DEBLJINA (mm)	DUŽINA (m)	ARTIKAL
1330042	ALUMINIJSKA LAJSNA PBR-2	ZLATNA	8	2,70	121084
1330001	ALUMINIJSKA LAJSNA PBR-2	SREBRENA	8	2,70	121085
1330002	ALUMINIJSKA LAJSNA PBR-2	BRONČANA	8	2,70	121086
1330047	ALUMINIJSKA LAJSNA PBR-2	BIJELA	8	2,70	121210
1330050	ALUMINIJSKA LAJSNA PBR-2	ANTRACIT	8	2,70	121213
1330056	ALUMINIJSKA LAJSNA PBR 2-1	ZLATNA	10	2,70	121079
1330019	ALUMINIJSKA LAJSNA PBR 2-1	SREBRENA	10	2,70	121078
1330020	ALUMINIJSKA LAJSNA PBR 2-1	BRONČANA	10	2,70	121098
1330048	ALUMINIJSKA LAJSNA PBR 2-1	BIJELA	10	2,70	121169
1330051	ALUMINIJSKA LAJSNA PBR 2-1	ANTRACIT	10	2,70	121211
1330069	ALUMINIJSKA LAJSNA PBR 2-2	ZLATNA	12	2,70	121088
1330021	ALUMINIJSKA LAJSNA PBR 2-2	SREBRENA	12	2,70	121077
1330022	ALUMINIJSKA LAJSNA PBR 2-2	BRONČANA	12	2,70	121087
1330049	ALUMINIJSKA LAJSNA PBR 2-2	BIJELA	12	2,70	121168
1330052	ALUMINIJSKA LAJSNA PBR 2-2	ANTRACIT	12	2,70	121212
1330029	ALUMINIJSKA LAJSNA PBR 2-3	SREBRENA	15	2,70	121106
1330040	ALUMINIJSKA LAJSNA PBR 2-3	BRONČANA	15	2,70	121115

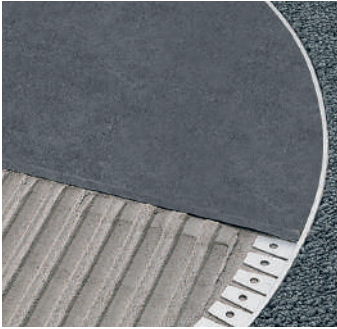
**SERIJA 2 - savitljiva**

- Aluminijski profili za dilataciju i zaštitu vanjskih kutova - savitljivi.
- Idealan je u funkciji razdjelnica podova od različitih materijala, primjerice keramike i tepiha.
- Dostupne su u tri boje: zlatna, srebrna, bronca

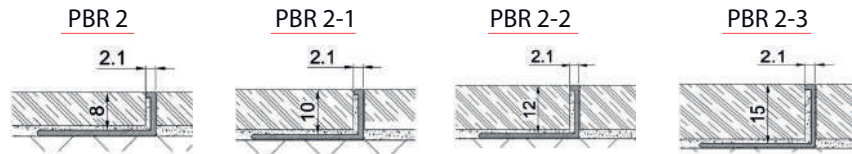

VOKEL ŠIFRA	OPIS	BOJA	DEBLJINA (mm)	DUŽINA (m)	ARTIKAL
1330034	ALUMINIJSKA LAJSNA PBR 2-1	SREBRENA	10	2,70	121145

**SERIJA 3.**

- Aluminijski profili za podove istih visina.
- Idealan za skrivanje spojeva od različitih materijala.
- Dostupne su u tri boje: zlatna, srebrna i bronca.

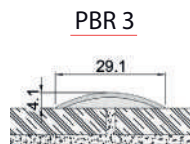

VOKEL ŠIFRA	OPIS	BOJA	DIMENZIJA (m)	ARTIKAL
1330070	ALUMINIJSKA LAJSNA PBR-3	SREBRENA	2,70	121032

**SERIJA 4.**

- Aluminijski profili za podove istih ili različitih visina.
- Dostupne su u tri boje: zlatna, srebrna i bronca.



VOKEL ŠIFRA	OPIS	BOJA	DIMENZIJA (m)	ARTIKAL
1330060	ALUMINIJSKA LAJSNA PBR-4	SREBRENA	2,70	121073
1330061	ALUMINIJSKA LAJSNA PBR-4	BRONČANA	2,70	121089
1330071	ALUMINIJSKA LAJSNA PBR-4	ZLATNA	2,70	121074
1330067	ALUMINIJSKA LAJSNA PBR-8-1 NOSAČ	SREBRENA	2,50	121040

SERIJA 5.

- Aluminijski profili za podove istih visina.
- Idealan je za prikrivanje nekih nedostataka koji su posljedica rezanja ili polaganja među podovima od različitih materijala
- Dostupne su u tri boje: zlatna, srebrna, bronca i antracit.

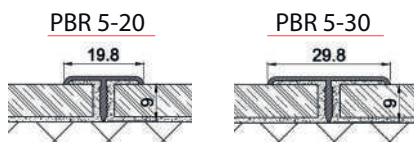

VOKEL ŠIFRA	OPIS	BOJA	ŠIRINA (mm)	DUŽINA (m)	ARTIKAL
1330004	ALUMINIJSKA LAJSNA PBR-5-20	SREBRENA	20	2,70	121014
1330003	ALUMINIJSKA LAJSNA PBR-5-20	BRONČANA	20	2,70	121013
1330005	ALUMINIJSKA LAJSNA PBR-5-20	ZLATNA	20	2,70	121015
1330080	ALUMINIJSKA LAJSNA PBR-5-20	ANTRACIT	20	2,70	121066
1330035	ALUMINIJSKA LAJSNA PBR-5-30	SREBRENA	30	2,70	121017
1330036	ALUMINIJSKA LAJSNA PBR-5-30	ZLATNA	30	2,70	121018
1330081	ALUMINIJSKA LAJSNA PBR-5-30	ANTRACIT	30	2,70	121214

SERIJA 6.

- Aluminijski profil za stepenice
- Dostupne su u tri boje: zlatna, srebrna, bronca i antracit.

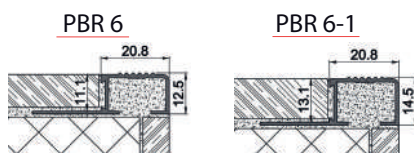

VOKEL ŠIFRA	OPIS	BOJA	DEBLJINA (mm)	DUŽINA (m)	ARTIKAL
1330006	ALUMINIJSKA LAJSNA PBR 6	SREBRENA	10	2,50	121127
1330078	ALUMINIJSKA LAJSNA PBR 6	ANTRACIT	10	2,50	121116
1330073	ALUMINIJSKA LAJSNA PBR 6-1	BRONČANA	10	2,50	121128
1330043	ALUMINIJSKA LAJSNA PBR 6-1	SREBRENA	8	2,50	121021
1330041	ALUMINIJSKA LAJSNA PBR 6-1	SREBRENA	14	2,50	-
1330079	ALUMINIJSKA LAJSNA PBR 6-1	ANTRACIT	14	2,50	121191

**SERIJA 7.**

- Aluminijski profil za stepenice koji se također koristi kao i okapnica za balkone
- Dostupne su u tri boje: zlatna, srebrna i bronca

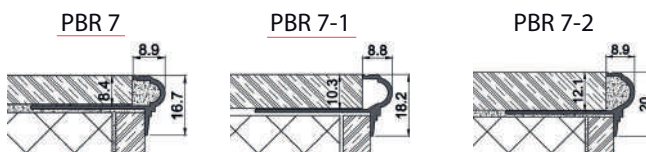

VOKEL ŠIFRA	OPIS	BOJA	DEBLJINA (mm)	DUŽINA (m)	ARTIKAL
1330027	ALUMINIJSKA LAJSNA PBR 7	ZLATNA	8	2,50	121029
1330026	ALUMINIJSKA LAJSNA PBR 7	SREBRENA	8	2,50	121028
1330007	ALUMINIJSKA LAJSNA PBR 7-1	ZLATNA	10	2,50	121006
1330008	ALUMINIJSKA LAJSNA PBR 7-1	SREBRENA	10	2,50	121026
1330009	ALUMINIJSKA LAJSNA PBR 7-1	BRONČANA	10	2,50	121027
1330012	ALUMINIJSKA LAJSNA PBR 7-2	ZLATNA	12	2,50	121082
1330010	ALUMINIJSKA LAJSNA PBR 7-2	SREBRENA	12	2,50	121080
1330011	ALUMINIJSKA LAJSNA PBR 7-2	BRONČANA	12	2,50	121081

**SERIJA 9.**

- Aluminijski cikl profil za prikrivanje kablova
- Dostupne su u tri boje: zlatna, srebrna i bronca



PBR 9

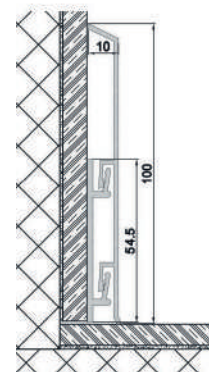

VOKEL ŠIFRA	OPIS	BOJA	VISINA (mm)	DUŽINA (m)	ARTIKAL
1330038	ALUMINIJSKA LAJSNA PBR 9	SREBRENA	100	3,00	121071
1330039	NOSAČ LAJSNE PBR 9-1	SREBRENA	-	-	121046
1330062	PVC SPOJNICA 9	SREBRENA	-	-	122624
1330063	PVC 9 UNUTARNJI KUT	SREBRENA	-	-	122621
1330064	PVC 9 VANJSKI KUT	SREBRENA	-	-	122618
1330065	PVC 9 LIJEVA ZAVRŠNA KAPA	SREBRENA	-	-	122627
1330066	PVC 9 DESNA ZAVRŠNA KAPA	SREBRENA	-	-	122628

SERIJA 11.

- Aluminijski profil za zatvaranje i zaštitu vanjskih kutova zidnih keramičkih obloga pomoću kojeg se izbjegavaju neestetski i krhki rezovi pod kutem od 45°, zaobljeni oblik daje istovremeno simetrični izgled i djeluje kao zaštita za kut obloge.
- Dostupne su u tri boje: zlatna, srebrna i bronca

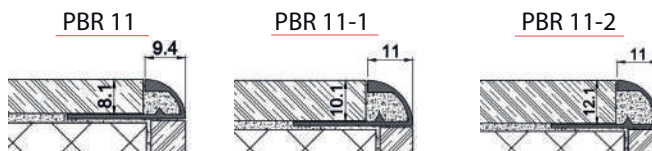

VOKEL ŠIFRA	OPIS	BOJA	DEBLJINA (mm)	DUŽINA (m)	ARTIKAL
1330023	ALUMINIJSKA LAJSNA PBR 11	SREBRENA	8	2,70	121022
1330024	ALUMINIJSKA LAJSNA PBR 11-1	SREBRENA	10	2,70	121024
1330059	ALUMINIJSKA LAJSNA PBR 11-1	BRONČANA	10	2,70	121025
1330025	ALUMINIJSKA LAJSNA PBR 11-2	SREBRENA	12	2,70	121090

SERIJA 12.

- Aluminijski profil za zatvaranje i zaštitu vanjskih zidnih keramičkih kutova, također se koristi kao i okapnica za balkone
- Dostupne su u tri boje: zlatna, srebrna i bronca

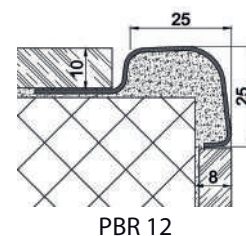

VOKEL ŠIFRA	OPIS	BOJA	DEBLJINA (mm)	DUŽINA (m)	ARTIKAL
1330037	ALUMINIJSKA LAJSNA PBR 12	SREBRENA	10	2,70	121048

SERIJA 13.

- Aluminijski profil za unutarnje kutove
- Dostupne su u tri boje: zlatna, srebrna i bronca

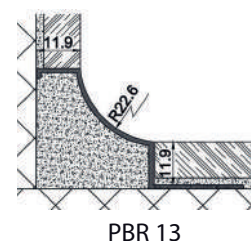

VOKEL ŠIFRA	OPIS	BOJA	DUŽINA (m)	ARTIKAL
1330033	ALUMINIJSKA LAJSNA PBR 13	SREBRENA	2,70	121052

**SERIJA 14.**

- Aluminijski profil za podove različitih visina
- Dostupne su u tri boje: zlatna, srebrna i bronca

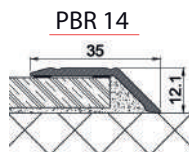

VOKEL ŠIFRA	OPIS	BOJA	DUŽINA (m)	ARTIKAL
1330057	ALUMINIJSKA LAJSNA PBR 14	BRONČANA	2,70	121110

**SERIJA 16.**

- Aluminijski profil za zatvaranje i zaštitu vanjskih kutova keramičkih obloga čijim se četvrtastim oblikom definira položena obloga i tako izbjegava neestetski i krhki rez pod kutom od 45° na rubovima pločica
- Također se koristi za dilataciju kao i bordura na zidnim oblogama
- Dostupne su u tri boje: zlatna, srebrna i bronca



VOKEL ŠIFRA	OPIS	BOJA	DEBLJINA (mm)	DUŽINA (m)	ARTIKAL
1330030	ALUMINIJSKA LAJSNA PBR 16-1	SREBRENA	10	2,70	121104
1330031	ALUMINIJSKA LAJSNA PBR 16-2	SREBRENA	12,5	2,70	121105

**SERIJA 17.**

- Aluminijski profil za okapnice balkona
- Dostupne su u tri boje: zlatna, srebrna, bronca i antracit.

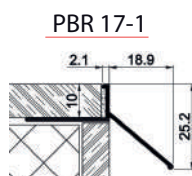

VOKEL ŠIFRA	OPIS	BOJA	DEBLJINA (mm)	DUŽINA (m)	ARTIKAL
1330032	ALUMINIJSKA LAJSNA PBR 17-1	SREBRENA	10	2,70	121151
1330055	ALUMINIJSKA LAJSNA PBR 17-1	BRONČANA	10	2,70	121152
1330075	ALUMINIJSKA LAJSNA PBR 17-1	ANTRACIT	10	2,70	121060

SERIJA 18.

- Aluminijski puni profil za stepenice
- Dostupne su u tri boje: zlatna, srebrna i bronca

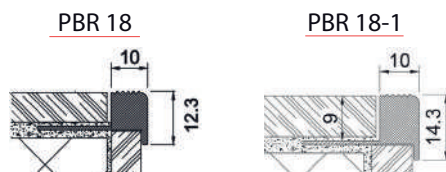

VOKEL ŠIFRA	OPIS	BOJA	DEBLJINA (mm)	DUŽINA (m)	ARTIKAL
1330044	ALUMINIJSKA LAJSNA PBR 18	SREBRENA	7	2,60	121165
1330045	ALUMINIJSKA LAJSNA PBR 18-1	SREBRENA	9	2,60	121163
1330072	ALUMINIJSKA LAJSNA PBR 18-1	BRONČANA	9	2,60	121176

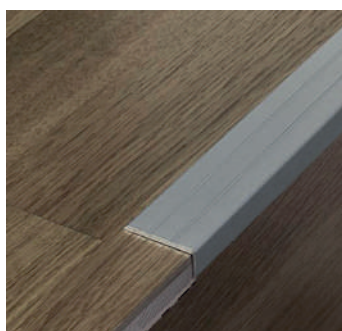
SERIJA 19.

- Aluminijski završni profil za laminare i parkete
- Dostupne su u tri boje: zlatna, srebrna i bronca

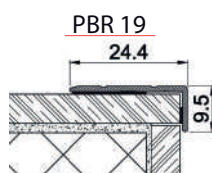

VOKEL ŠIFRA	OPIS	BOJA	ŠIRINA (mm)	DUŽINA (m)	ARTIKAL
1330013	ALUMINIJSKA LAJSNA PBR 19	ZLATNA	24,4	2,70	121034
1330014	ALUMINIJSKA LAJSNA PBR 19	SREBRENA	24,4	2,70	121035
1330015	ALUMINIJSKA LAJSNA PBR 19	BRONČANA	24,4	2,70	121036

SERIJA 20.

- Aluminijski završni profil za laminare i parkete
- Dostupne su u tri boje: zlatna, srebrna i bronca

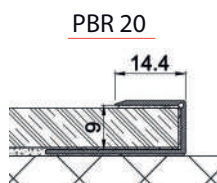

VOKEL ŠIFRA	OPIS	BOJA	DEBLJINA (mm)	DUŽINA (m)	ARTIKAL
1330016	ALUMINIJSKA LAJSNA PBR 20	ZLATNA	9	2,70	121043
1330017	ALUMINIJSKA LAJSNA PBR 20	SREBRENA	9	2,70	121057
1330018	ALUMINIJSKA LAJSNA PBR 20	BRONČANA	9	2,70	121058

**SERIJA 21.**

- Aluminijski profil za zaštitu vanjskih kutova
- Dostupne su u tri boje: zlatna, srebrna i bronca

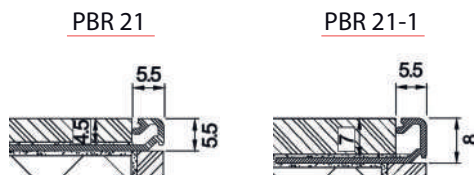

VOKEL ŠIFRA	OPIS	BOJA	DEBLJINA (mm)	DUŽINA (m)	ARTIKAL
1330046	ALUMINIJSKA LAJSNA PBR 21	SREBRENA	4,5	2,70	121178
1330053	ALUMINIJSKA LAJSNA PBR 21-1	SREBRENA	7	2,70	121181
1330054	ALUMINIJSKA LAJSNA PBR 21-1	BRONČANA	7	2,70	121182

**SERIJA 22.**

- Aluminijski profil za zaštitu vanjskih kutova
- Dostupne boje: antracit.

PBR 22-1-2-SR



VOKEL ŠIFRA	OPIS	BOJA	DEBLJINA (mm)	DUŽINA (m)	ARTIKAL
1330082	ALUMINIJSKA LAJSNA PBR 22-1-2-SR	SREBRENA	4,5	2,70	121184

	ŠIFRA VOKEL	Opis.	Stjenka deb.	Ø promj.	PAKOVANJE/ PAKET/m	JED. MJ.
	0726001	Cijevna izolacija EV IT-FLEX L=2 m	9	15	192	m
	0726002	Cijevna izolacija EV IT-FLEX L=2 m	9	18	166	m
	0726003	Cijevna izolacija EV IT-FLEX L=2 m	9	22	136	m
	0726004	Cijevna izolacija EV IT-FLEX L=2 m	9	28	98	m
	0726005	Cijevna izolacija EV IT-FLEX L=2 m	9	35	76	m
	0726006	Cijevna izolacija EV IT-FLEX L=2 m	9	42	60	m
	0726007	Cijevna izolacija EV IT-FLEX L=2 m	9	48	50	m
	0726008	Cijevna izolacija EV IT-FLEX L=2 m	9	54	46	m
	0726009	Cijevna izolacija EV IT-FLEX L=2 m	9	60	46	m
	0726010	Cijevna izolacija EV IT-FLEX L=2 m	9	76	40	m
	0726011	Cijevna izolacija EV IT-FLEX L=2 m	9	89	36	m
	0726012	Cijevna izolacija EV IT-FLEX L=2 m	9	102	22	m
	0726013	Cijevna izolacija EV IT-FLEX L=2 m	9	108	22	m
	0726014	Cijevna izolacija EV IT-FLEX L=2 m	9	114	22	m
	0726015	Cijevna izolacija EV IT-FLEX L=2 m	13	15	136	m
	0726016	Cijevna izolacija EV IT-FLEX L=2 m	13	18	118	m
	0726017	Cijevna izolacija EV IT-FLEX L=2 m	13	22	98	m
	0726018	Cijevna izolacija EV IT-FLEX L=2 m	13	28	78	m
	0726019	Cijevna izolacija EV IT-FLEX L=2 m	13	35	58	m
	0726020	Cijevna izolacija EV IT-FLEX L=2 m	13	42	48	m
	0726021	Cijevna izolacija EV IT-FLEX L=2 m	13	48	40	m
	0726022	Cijevna izolacija EV IT-FLEX L=2 m	13	54	34	m
	0726023	Cijevna izolacija EV IT-FLEX L=2 m	13	60	32	m
	0726024	Cijevna izolacija EV IT-FLEX L=2 m	13	76	26	m
	0726025	Cijevna izolacija EV IT-FLEX L=2 m	13	89	24	m
	0726026	Cijevna izolacija EV IT-FLEX L=2 m	13	102	16	m
	0726027	Cijevna izolacija EV IT-FLEX L=2 m	13	108	16	m
	0726050	Cijevna izolacija EV IT-FLEX L=2 m	13	114	16	m
	0726028	Cijevna izolacija EV IT-FLEX L=2 m	19	15	78	m
	0726029	Cijevna izolacija EV IT-FLEX L=2 m	19	18	72	m
	0726030	Cijevna izolacija EV IT-FLEX L=2 m	19	22	64	m
	0726031	Cijevna izolacija EV IT-FLEX L=2 m	19	28	48	m
	0726032	Cijevna izolacija EV IT-FLEX L=2 m	19	35	36	m
	0726033	Cijevna izolacija EV IT-FLEX L=2 m	19	42	32	m
0726034	Cijevna izolacija EV IT-FLEX L=2 m	19	48	24	m	
0726035	Cijevna izolacija EV IT-FLEX L=2 m	19	54	24	m	
0726036	Cijevna izolacija EV IT-FLEX L=2 m	19	60	22	m	
0726037	Cijevna izolacija EV IT-FLEX L=2 m	19	76	18	m	
0726038	Cijevna izolacija EV IT-FLEX L=2 m	19	89	14	m	
0726039	Cijevna izolacija EV IT-FLEX L=2 m	19	102	14	m	
0726040	Cijevna izolacija EV IT-FLEX L=2 m	19	108	12	m	
0726051	Cijevna izolacija EV IT-FLEX L=2 m	19	114	12	m	

	ŠIFRA VOKEL	Opis.	Stjenka deb.	jed.mj.	PAKOVANJE/ m ²
	0726041	Izolacija u ploči EV IT-FLEX	6	m ²	30
	0726042	Izolacija u ploči EV IT-FLEX	10	m ²	20
	0726043	Izolacija u ploči EV IT-FLEX	13	m ²	14
	0726044	Izolacija u ploči EV IT-FLEX	19	m ²	10
	0726045	Izolacija u ploči EV IT-FLEX samoljepljiva	6	m ²	30
	0726046	Izolacija u ploči EV IT-FLEX samoljepljiva	10	m ²	20
	0726047	Izolacija u ploči EV IT-FLEX samoljepljiva	13	m ²	14
	0726048	Izolacija u ploči EV IT-FLEX samoljepljiva	19	m ²	10
	0726049	Samoljepljiva izolacijska traka EV IT-FLEX 50 mm x 3 mm x 15 m		kom	12
	0726054	CIJEVNA IZOLACIJA IT-FLEX SOLAR 22x13		m ¹	30
	0726055	CIJEVNA IZOLACIJA K-FLEX SOLAR 28x13		m ¹	30
	0726052	LJEPILO ZA IZOLACIJU EV 0,8 Litara		kom	12
	0726053	LJEPILO ZA IZOLACIJU EV 0,425 Litara		kom	24

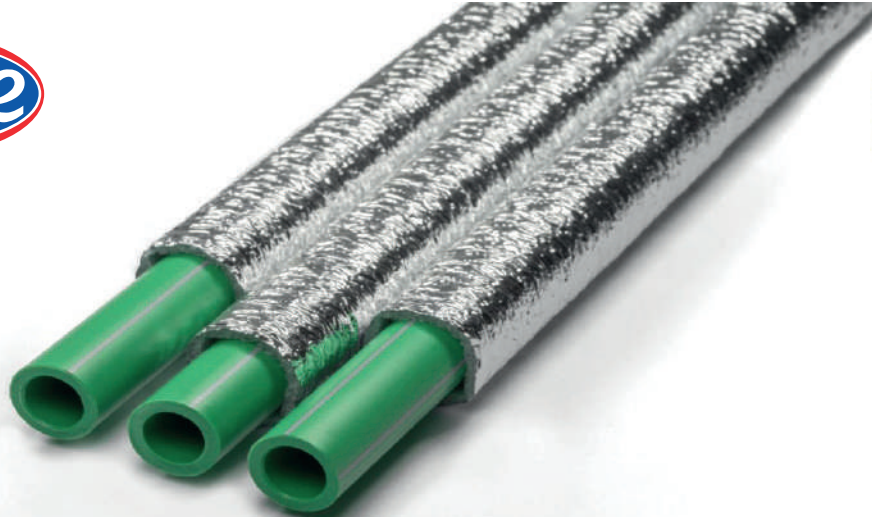

PlamaFLEX SSL+ ALPet

OPIS: PlamaFLEX SSL+ ALPet cjevna izolacija izrađena je od ekspandiranog polietilena i proizvodi se u skladu sa internacionalnim standardom CE EN 14313. Ova visokokvalitetna cjevna izolacija ima dodatni unutrašnji sloj HD folije i vanjski zaštitni sloj ALPet folije koja osigurava odličnu zaštitu od mehaničkih utjecaja, te pruža odličnu termičku i zvučnu izolaciju cjevi. Izrađuje se u sivoj boji sa debljinom stjenke 4mm. Vanjski sloj ALPet folije daje napredne izolacijske karakteristike posebno u sprečavanju nastanka kondenzacije obzirom da je koeficijent difuzije vodene pare $\mu = 17\ 000$.

KARAKTERISTIKE PROIZVODA

- Debljina EPE (ISO 1923) - $4 \pm 10\%$ mm
- Gustoća EPE (ISO 845) - $25 \pm 10\%$ kg/m³
- Termička stabilnost (ISO 2796) (24h) -30°C : $-0,1\%$; $+90^{\circ}\text{C}$: $-3,7\%$
- Paropropustnost (ISO 1663) $>17000\mu$
- Toplotna provodljivost (DIN 52613) - $< 0,036$ W/mK
- Boja - srebrna

PRIMJENA: Plama FLEX ispunjava najvažnije kriterije za izolaciju centralnih grijanih cjevovoda, klima izolacije, sanitarne izolacije i odvodnih cjevovoda. Osnovna karakteristika cjevne izolacije je elastičnost i visoka otpornost na oštećenja. Zatvoreno ćelijska cjevna izolacija pogodna je za montažu ispod žbuke i plivajućeg poda. Plama FLEX SSL AL pet izolacija, s obzirom da je prekrivena slojem ALPET srebrne folije, povećava otpornost na difuziju vodene pare i daje fini dekorativni izgled dok dodatni unutrašnji sloj sloj HD folije omogućava bržu i efikasniju ugradnju

Asortiman Plama FLEX SSL + ALPet cjevne izolacije:

Šifra Vokel	VANJSKI PROMJER INSTALACIJE		Debljina stjenke «B» mm	Pakiranje (m/paket)
	Bakrene cijevi «A» mm	Čelične cijevi "		
0703087	15	1/4	4	210
0703088	18	3/8	4	210
0703089	22	1/2	4	210
0703090	28	3/4	4	210
0703091	35	1	4	120
0703092	42	1+1/4	4	120

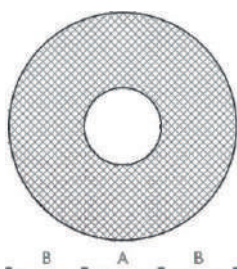

	<p>71169</p> <p>0635209</p> <p>0635210</p> <p>71252</p>	<p>BOJLER ELEKTRIČNI PROTOČNI VED 12/6 12 kW ART.308015</p> <p>BOJLER ELEKTRIČNI PROTOČNI VED E 18/7 18 kW ART.0010014913</p> <p>BOJLER ELEKTRIČNI PROTOČNI VED E 21/7 21 kW ART.0010014914</p> <p>BOJLER ELEKTRIČNI PROTOČNI VED 24/6 24 kW ART.308018</p>
	<p>0635192</p> <p>0635193</p>	<p>BOJLER ELEKTRIČNI PROTOČNI VED E 18/7 INT ART.10007720</p> <p>BOJLER ELEKTRIČNI PROTOČNI VED E 21/7 INT ART.10007721</p>
	<p>0681023</p> <p>0681024</p> <p>0681025</p> <p>0681026</p> <p>0681027</p> <p>0681028</p> <p>0681029</p> <p>0681030</p> <p>0681031</p> <p>0681032</p>	<p>TERMO BLOK VE 6 kW VE6/14 SEE ART.0010023706</p> <p>TERMO BLOK VE 9 kW VE9/14 SEE ART.0010023707</p> <p>TERMO BLOK VE 12 kW VE12/14 SEE ART.0010023708</p> <p>TERMO BLOK VE 14 kW VE14/14 SEE ART.0010023709</p> <p>TERMO BLOK VE 18 kW VE18/14 SEE ART.0010023710</p> <p>TERMO BLOK VE 21 kW VE21/14 SEE ART.0010023711</p> <p>TERMO BLOK VE 24 kW VE24/14 SEE ART.0010023712</p> <p>TERMO BLOK VE 28 kW VE28/14 SEE ART.0010023713</p> <p>SPOJNI SET (TROSMJERNI VENTIL+NTC OSJETNIK) ART.0010027587</p> <p>VANJSKI TEMPERATURNI OSJETNIK ART.0020266791</p>
	<p>0635228</p> <p>0635229</p> <p>0635230</p> <p>0635231</p>	<p>ELEKTRIČNA SOBNA GRIJALICA VER 100/5 1 kW ART.10023956</p> <p>ELEKTRIČNA SOBNA GRIJALICA VER 150/5 1,5 kW ART.10023957</p> <p>ELEKTRIČNA SOBNA GRIJALICA VER 200/5 2 kW ART.10023958</p> <p>ELEKTRIČNA SOBNA GRIJALICA VER 250/5 2,5 kW ART.10023959</p>

Zašto Vaillant?

Mi upotpunjujemo naše sustave.

Panelni radijatori



Jer  Vaillant misli dalje.

Kompaktni radijatori Tip 22 2 panela, 2konvektora					
		visina / mm			
		Vokel Šifra			
		300	500	600	900
dužina / mm	400			1471005	1471001
	500				
	600		1471016	1471006	1472002
	700				
	800	1471024	1471017	1471007	1471003
	900				
	1000	1471025	1471018	1471008	1471004
	1100				
	1200	1471026	1471019	1471009	
	1300				
	1400	1471027	1471020	1471010	
	1500				
	1600	1471028	1471021	1471011	
	1800	1471029	1471022	1471012	
	2000	1471030	1471023	1471013	
	2200			1471014	
	2400			1471015	
2600					
2800					
3000					

Šifra Vokel

Ventilski radijatori Tip 22 2 panela, 2konvektora					
		visina / mm			
		Vokel Šifra			
		300	500	600	900
dužina / mm	400			1472006	1472001
	500				
	600		1472017	1472007	1472002
	700				
	800	1472025	1472018	1472008	1472003
	900				
	1000	1472026	1472019	1472009	1472004
	1100				
	1200	1472027	1472020	1472010	1472005
	1300				
	1400	1472028	1472021	1472011	
	1500				
	1600	1472029	1472022	1472012	
	1800	1472030	1472023	1472013	
	2000	1472031	1472024	1472014	
	2200			1472015	
	2400			1472016	
2600					
2800					
3000					

Šifra Vokel

Kompaktni radiator Tip 22: 2 panela, 2konvektora

ŠIFRA VOKEL	OPIS	DIMENZIJA	ART.
1471001	Radijator Vaillant kompakt	K22 H900 L400	0919041211
1471002	Radijator Vaillant kompakt	K22 H900 L600	0919061211
1471003	Radijator Vaillant kompakt	K22 H900 L800	0919081211
1470004	Radijator Vaillant kompakt	K22 H900 L1000	0919101211
1471005	Radijator Vaillant kompakt	K22 H600 L400	1916041211
1471006	Radijator Vaillant kompakt	K22 H600 L600	0916061211
1471007	Radijator Vaillant kompakt	K22 H600 L800	0916081211
1471008	Radijator Vaillant kompakt	K22 H600 L1000	0916101211
1471009	Radijator Vaillant kompakt	K22 H600 L1200	0916121211
1471010	Radijator Vaillant kompakt	K22 H600 L1400	0916141211
1471011	Radijator Vaillant kompakt	K22 H600 L1600	0916161211
1471012	Radijator Vaillant kompakt	K22 H600 L1800	0916181211
1471013	Radijator Vaillant kompakt	K22 H600 L2000	0916201211
1471014	Radijator Vaillant kompakt	K22 H600 L2200	0916221211
1471015	Radijator Vaillant kompakt	K22 H600 L2400	0916241211
1471016	Radijator Vaillant kompakt	K22 H500 L600	0915061211
1471017	Radijator Vaillant kompakt	K22 H500 L800	0915081211
1471018	Radijator Vaillant kompakt	K22 H500 L1000	0915101211
1471019	Radijator Vaillant kompakt	K22 H500 L1200	0915121211
1471020	Radijator Vaillant kompakt	K22 H500 L1400	0915141211
1471021	Radijator Vaillant kompakt	K22 H500 L1600	0915161211
1471022	Radijator Vaillant kompakt	K22 H500 L1800	0915181211
1471023	Radijator Vaillant kompakt	K22 H500 L2000	0915201211
1471024	Radijator Vaillant kompakt	K22 H300 L800	0913081211
1471025	Radijator Vaillant kompakt	K22 H300 L1000	0913101211
1471026	Radijator Vaillant kompakt	K22 H300 L1200	0913121211
1471027	Radijator Vaillant kompakt	K22 H300 L1400	0913141211
1471028	Radijator Vaillant kompakt	K22 H300 L1600	0913161211
1471029	Radijator Vaillant kompakt	K22 H300 L1800	0913181211
1471030	Radijator Vaillant kompakt	K22 H300 L2000	0913201211

Ventilski radiator Tip 22: 2 panela, 2konvektora

ŠIFRA VOKEL	OPIS	DIMENZIJA	ART.
1472001	Radijator Vaillant ventilski	V22 H900 L400	0919042241
1472002	Radijator Vaillant ventilski	V22 H900 L600	0919062241
1472003	Radijator Vaillant ventilski	V22 H900 L800	0919082241
1472004	Radijator Vaillant ventilski	V22 H900 L1000	091902241
1472005	Radijator Vaillant ventilski	V22 H900 L1200	0919122241
1472006	Radijator Vaillant ventilski	V22 H600 L400	0916042241
1472007	Radijator Vaillant ventilski	V22 H600 L600	0916062241
1472008	Radijator Vaillant ventilski	V22 H600 L800	0916082241
1472009	Radijator Vaillant ventilski	V22 H600 L1000	0916102241
1472010	Radijator Vaillant ventilski	V22 H600 L1200	0916122241
1472011	Radijator Vaillant ventilski	V22 H600 L1400	0916142241
1472012	Radijator Vaillant ventilski	V22 H600 L1600	0916162241
1472013	Radijator Vaillant ventilski	V22 H600 L1800	0916182241
1472014	Radijator Vaillant ventilski	V22 H600 L2000	0916202241
1472015	Radijator Vaillant ventilski	V22 H600 L2200	0916222241
1472016	Radijator Vaillant ventilski	V22 H600 L2400	0916242241
1472017	Radijator Vaillant ventilski	V22 H500 L600	0915062241
1472018	Radijator Vaillant ventilski	V22 H500 L800	0915082241
1472019	Radijator Vaillant ventilski	V22 H500 L1000	0915102241
1472020	Radijator Vaillant ventilski	V22 H500 L1200	0915122241
1472021	Radijator Vaillant ventilski	V22 H500 L1400	0915142241
1472022	Radijator Vaillant ventilski	V22 H500 L1600	0915162241
1472023	Radijator Vaillant ventilski	V22 H500 L1800	0915182241
1472024	Radijator Vaillant ventilski	V22 H500 L2000	0915202241
1472025	Radijator Vaillant ventilski	V22 H300 L800	0913082241
1472026	Radijator Vaillant ventilski	V22 H300 L1000	0913102241
1472027	Radijator Vaillant ventilski	V22 H300 L1200	0913122241
1472028	Radijator Vaillant ventilski	V22 H300 L1400	0913142241
1472029	Radijator Vaillant ventilski	V22 H300 L1600	0913162241
1472030	Radijator Vaillant ventilski	V22 H300 L1800	0913182241
1472031	Radijator Vaillant ventilski	V22 H300 L2000	0913202241

Kompaktni i ventilski radijatori

Toplinski učinak (W)

Tip	Temp.	Visina mm	Dužina (mm)																				
			400	500	600	700	800	900	1000	1100	1200	1300	1400	1500	1600	1800	2000	2200	2400	2600	2800	3000	
11	90/70/20	500	424	531	637	743	849	955	1,061	1,167	1,273	1,379	1,485	1,592	1,698	1,910	2,122	2,334	2,546	2,759	2,971	3,183	
	75/65/20	500	332	415	497	580	663	746	829	912	995	1,078	1,161	1,244	1,326	1,492	1,658	1,824	1,990	2,155	2,321	2,487	
	90/70/20	600	487	609	731	853	974	1,096	1,218	1,340	1,462	1,583	1,705	1,827	1,949	2,192	2,436	2,680	2,923	3,167	3,410	3,654	
	75/65/20	600	381	476	571	666	762	857	952	1,047	1,142	1,238	1,333	1,428	1,523	1,714	1,904	2,094	2,285	2,475	2,666	2,856	
	20/70/20	900	658	823	987	1,152	1,316	1,481	1,645	1,810	1,974												
	75/65/20	900	515	644	772	901	1,030	1,158	1,287	1,416	1,544												
21	90/70/20	500	606	758	910	1,061	1,213	1,364	1,516	1,668	1,819	1,971	2,122	2,274	2,426	2,729	3,032						
	75/65/20	500	474	593	711	830	948	1,067	1,185	1,304	1,422	1,541	1,659	1,778	1,896	2,133	2,370						
	90/70/20	600	696	870	1,044	1,218	1,392	1,566	1,740	1,914	2,088	2,262	2,436	2,610	2,784	3,132	3,480						
	75/65/20	600	544	681	817	953	1,089	1,225	1,361	1,497	1,633	1,769	1,905	2,042	2,178	2,450	2,722						
	90/70/20	900	940	1,175	1,410	1,645	1,880	2,115	2,350	2,585	2,820	3,055	3,290	3,525	3,760	4,230	4,700						
	75/65/20	900	736	920	1,104	1,288	1,472	1,656	1,840	2,024	2,208	2,392	2,576	2,760	2,944	3,312	3,680						
22	90/70/20	300	535	699	803	937	1,070	1,204	1,338		1,606		1,873		2,141	2,408	2,676	2,944	3,211	3,479	3,746	4,014	
	75/65/20	300	421	526	631	736	842	947	1,052		1,262		1,473		1,683	1,894	2,104	2,314	2,525	2,735	2,946	3,156	
	90/70/20	400	670	838	1,005	1,173	1,340	1,508	1,675		2,010		2,345		2,680	3,015	3,350	3,685	4,020	4,355	4,690	5,025	
	75/65/20	400	526	658	789	921	1,052	1,184	1,315		1,578		1,841		2,104	2,367	2,630	2,893	3,156	3,419	3,682	3,945	
	90/70/20	500	798	998	1,197	1,397	1,596	1,796	1,995	2,195	2,394	2,594	2,793	2,993	3,192	3,591	3,990	4,389	4,788	5,187	5,586	5,985	
	75/65/20	500	625	782	938	1,094	1,250	1,407	1,563	1,719	1,876	2,032	2,188	2,345	2,501	2,813	3,126	3,439	3,751	4,064	4,376	4,689	
	90/70/20	600	920	1,150	1,380	1,610	1,840	2,070	2,300	2,530	2,760	2,990	3,220	3,450	3,680	4,140	4,600	5,060	5,520	5,980	6,440	6,900	
	75/65/20	600	719	899	1,079	1,259	1,438	1,618	1,798	1,978	2,158	2,337	2,517	2,697	2,877	3,236	3,596	3,956	4,315	4,675	5,034	5,394	
	90/70/20	900	1,255	1,569	1,882	2,196	2,510	2,823	3,137	3,451	3,764	4,077	4,392	4,706	5,019	5,647	6,274	6,901	7,529	8,156	8,784	9,411	
	75/65/20	900	979	1,224	1,469	1,714	1,958	2,203	2,448	2,693	2,938	3,182	3,427	3,672	3,917	4,406	4,896	5,386	5,875	6,365	6,854	7,344	
33	90/70/20	300	766		1,150		1,533		1,916		2,299		6,682		3,066	3,449	3,832	4,215	4,598	4,982	5,365	5,748	
	75/65/20	300	602		904		1,205		1,506		1,807		2,108		2,410	2,711	3,012	3,313	3,614	3,916	4,217	4,518	
	90/70/20	600	1,300	1,626	1,951		2,601	2,926	3,251	3,576	3,901	4,226	4,551	4,877	5,202	5,852	6,502	7,152	7,802	8,453	9,103	9,753	
	75/65/20	600	1,018	1,273	1,528		2,037	2,291	2,546	2,801	3,055	3,310	3,564	3,819	4,074	4,583	5,092	5,601	6,110	6,620	7,129	7,638	
	90/70/20	900	1,753	2,191	2,629	3,067	3,506	3,944	4,382	4,820	5,258	5,697	6,135	6,573	7,011	7,888	8,764						
	75/65/20	900	1,368	1,710	2,025	2,394	2,736	3,078	3,420	3,762	4,104	4,446	4,788	5,130	5,472	6,156	6,840						

Legenda:

- K označava kompaktne radijatore.
- V označava ventilski radijatore s ventilom.

Skladišni program:

- V i K
 - K
- Ostale dimenzije prema narudžbi.

Mjere za montažu kompaktnog radijatora

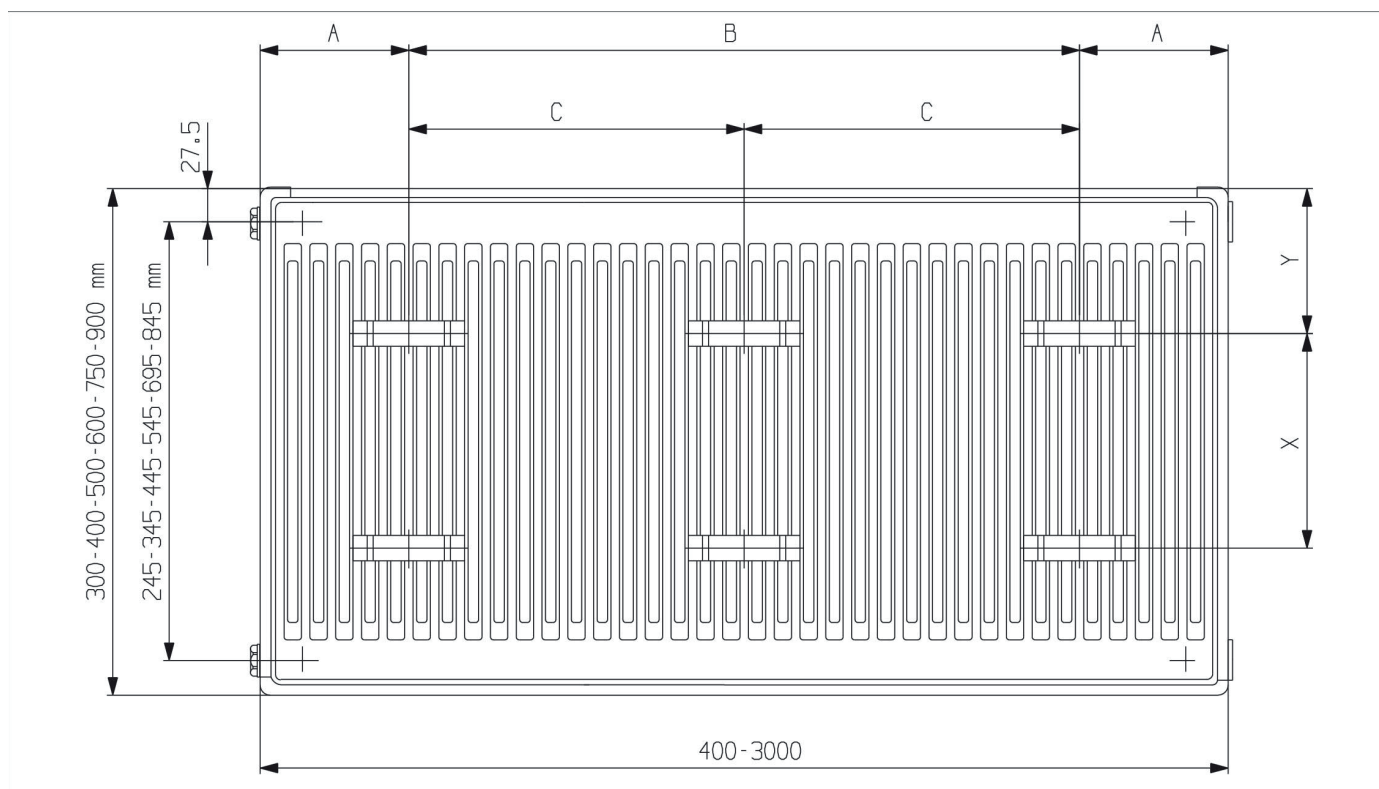

Tehnički podaci

Tip	X	Y	Dužina	Br. držača	L (mm)	11			21 - 22 - 23		
						A mm	B mm	B mm	A mm	B mm	C mm
300	155	72.5	400mm - 1500mm	4	400	125	150	-	137,5	125	-
400	155	122.5			500	125	250	-	137,5	225	-
500	255	122.5	1600mm - 3000mm	6	600	125	350	-	137,5	325	-
600	355	122.5			700	125	450	-	137,5	425	-
900	655	122.5			800	125	550	-	137,5	525	-
					900	125	650	-	137,5	625	-
					1000	125	750	-	137,5	725	-
					1100	125	850	-	137,5	825	-
					1200	125	950	-	137,5	925	-
					1300	125	1050	-	137,5	1025	-
					1400	125	1150	-	137,5	1125	-
					1500	125	1250	-	137,5	1225	-
			1600	125	-	675	137,5	-	662,5		
			1800	125	-	775	137,5	-	762,5		
			2000	125	-	875	137,5	-	862,5		
			2200	125	-	975	137,5	-	962,5		
			2400	125	-	1075	137,5	-	1062,5		
			2600	125	-	1175	137,5	-	1162,5		
			2800	125	-	1275	137,5	-	1262,5		
			3000	125	-	1375	137,5	-	1362,5		

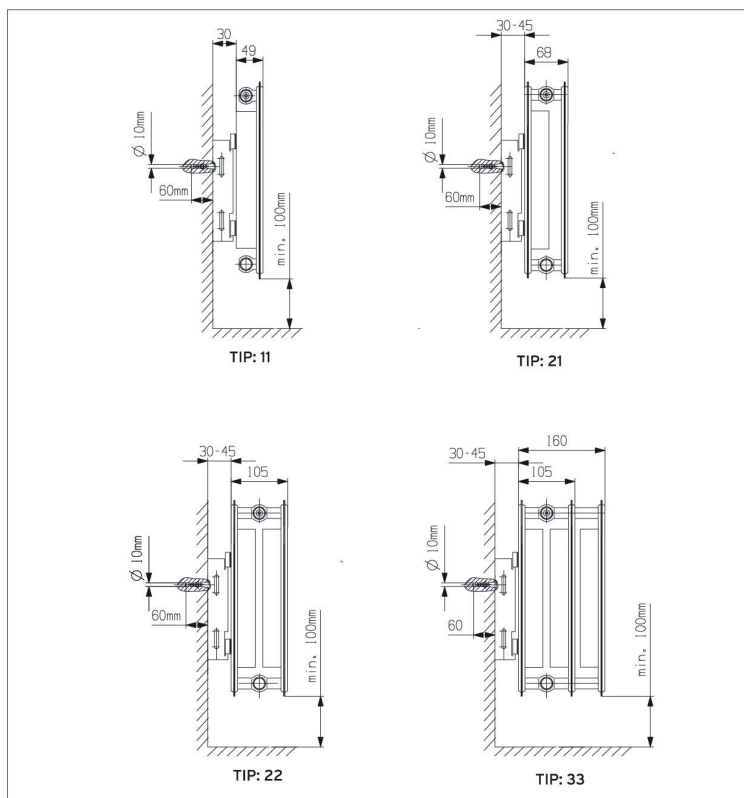

Mjere za montažu ventilskog radijatora

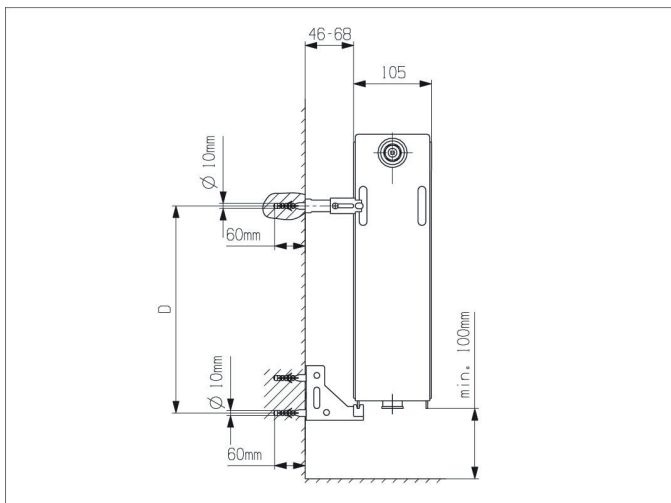

Tip radijatora 21, 22

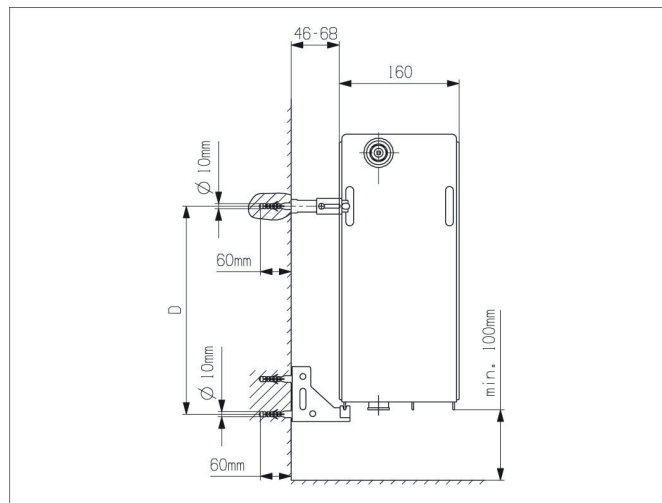

Tip radijatora 33

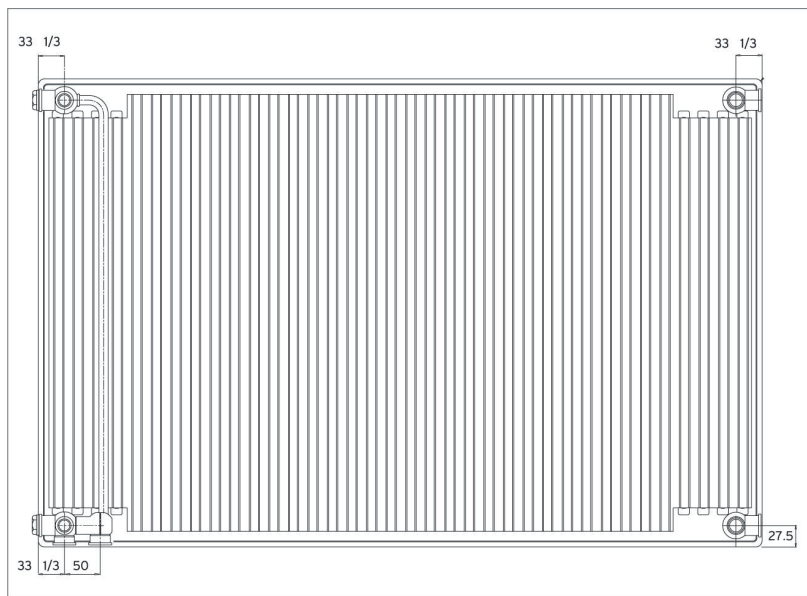
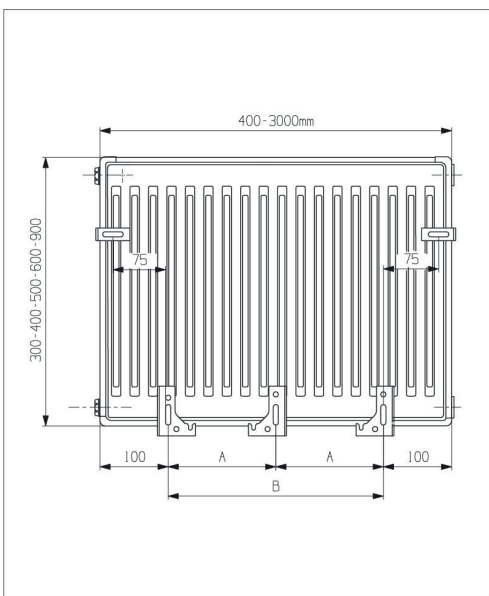

Tehnički podaci

Visina radijatora (mm)	Kota "D" (mm)
300	200
400	300
500	400
600	500
900	800

Dužina radijatora (mm)	Kota "A" (mm) Kota "B" (mm)	
	Kota "A" (mm)	Kota "B" (mm)
400	-	200
500	-	300
600	-	400
700	-	500
800	-	600
900	-	700

Dužina radijatora (mm)	Kota "A" (mm) Kota "B" (mm)	
	Kota "A" (mm)	Kota "B" (mm)
1000	-	800
1100	-	900
1200	-	1000
1300	-	1100
1400	-	1200
1500	-	1300
1600	700	1400
1800	800	1600
2000	900	1800
2200	1000	2000
2400	1100	2200
2600	1200	2400
2800	1300	2600
3000	1400	2800

Materijal i montaža

Osnovni podaci za Vaillant radijatore sažeti su u nastavnoj tablici:

	Vaillant radijatori
Probni tlak	13 bar
Maks. radni tlak	10 bar
Maks. radna temperatura	120 °C
Priključci	1/2"
Certificirano	ISO 9000
Antikorozivna zaštita	- hladno valjani čelični lim - Zn fosfatiranje - katodno temeljno bojanje - elektrostatski nanos praškastog materijala, RAL 9010
Toplinski učinak utvrđen prema	EN 442
Profiliran panel - korak	25 mm
Debljina lima	1,15 mm



Tehnički podaci

Tip	Visina	Razmak između priključaka	Dubina	Dužina min/maks.	Težina (kg/m)	Sadržaj vode (l/m)	« n »
K/V - 11	500	445	49	400-3000	15,1	2,5	1,3619000
	600	545	49	400-3000	17,8	2,9	1,3744000
	900	845	49	400-2000	26,3	4,2	1,3757000
K/V - 21	500	445	68	400-2000	24,7	4,9	1,3458000
	600	545	68	400-3000	29,3	5,8	1,3533000
	900	845	68	400-2000	43	8,3	1,3746000
K/V - 22	300	245	105	400-3000	19,3	3	1,3325000
	400	345	105	400-3000	24,8	3,9	1,3349000
	500	445	105	400-3000	30,2	4,8	1,3373000
	600	545	105	400-3000	35,5	5,7	1,3397000
	900	845	105	400-3000	52,3	8,7	1,3759000
K/V - 33	300	245	160	400-3000	28,8	4,5	1,3383000
	600	545	160	400-3000	53,2	8,7	1,3613000
	900	845	160	400-2000	79,5	10,2	1,3904000

Legenda:

- K označava kompaktne radijatore bez ventila i sa fiksiranim, stražnjim držačima.
- V označava ventilne radijatore s ventilom bez stražnjih držača ali s dojnim držačima (u obimu isporuke).

Tipovi panelnih radijatora

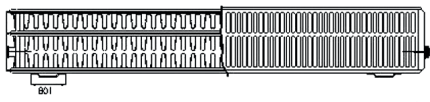
Tip 11		= 1 panel + 1 konvektor
Tip 21		= 2 panela + 1 konvektor
Tip 22		= 2 panela + 2 konvektora
Tip 33		= 3 panela + 3 konvektora

Jamstvo za Vaillant radijatore : 10 godina

Vaillant radijatori ukratko:

- kompaktni i ventilski radijatori
- hladno valjani čelični lim debljine 1,2 mm s antikorozivnom zaštitom
- dužine 400 do 3000 mm i visine 300 do 900 mm
- tipovi od 11 (1 panel + 1 konvektor) do 33 (3 panela + 3 konvektora)
- nosači radijatora su sastavni dio isporuke



Certifikati i priznanja

Dokaz vrhunske kvalitete i pouzdanosti su i dodijeljeni certifikati i priznanja.



Elektro kotao EI-Cm CLASSIC

OSNOVNE DIMENZIJE:

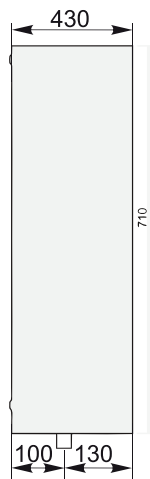
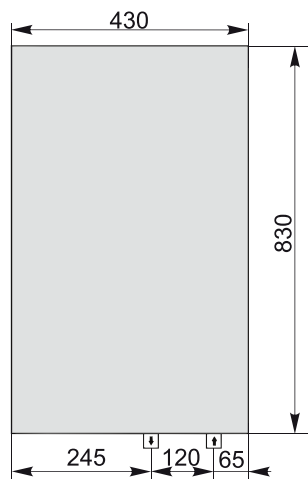

Regulacija - EI-Cm Classic



Moderna digitalna modularajuća regulacija optimalno vodi rad elektrogrijača tako da optimizira potrošnju električne energije sa učinkom elektrokotla.

EI-Cm Classic		6	9	12	18	24	27
Toplinski učin	(kW)	6	9	12	18	24	27
Sadržaj vode u kotlu	(lit.)	12,5	12,5	12,5	12,5	12,5	12,5
Masa kotla (bez vode)	(kg)	23	24	24	25	25	25
Max. radna temperatura	(°C)	80					
Max. radni pretlak	(bar)	2,5					
Polazni/povratni vod		DN20 (3/4")					
Električni grijači	(kW)	3x2	3+6	2x6	3x6	4x6	4x6,75
Presjek vodiča	(mm ²)	5x2,5	5x2,5	5x4	5x6	5x6	5x6
Ekspanzijska posuda	(lit.)	10					
Priključni napon	(V/Hz)	400/50					
Širina kotla	(mm)	430					
Visina kotla	(mm)	710					
Dubina kotla	(mm)	230					
Razred energetske učinkovitosti		D					



1453001 ELEKTRO KOTAO EL- CM CLASSIC 6 kW

1453003 ELEKTRO KOTAO EL- CM CLASSIC 12 kW

1453004 ELEKTRO KOTAO EL - CM CLASSIC 18 kW

Elektro kotao EI-Cm ePlus

OSNOVNE DIMENZIJE:

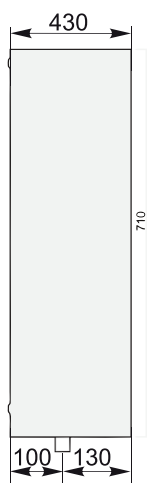
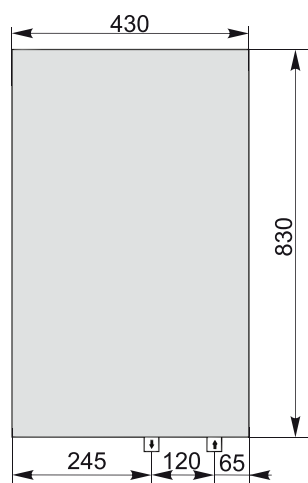

Regulacija - EI-Cm Classic



Moderna digitalna modulirajuća regulacija optimalno vodi rad elektrogrijača tako da optimizira potrošnju električne energije sa učinkom elektrokotla.

EI-Cm ePlus		6	9	12	18	24
Toplinski učin	(kW)	6	9	12	18	24
Sadržaj vode u kotlu	(lit.)	12,5	12,5	12,5	12,5	12,5
Masa kotla (bez vode)	(kg)	25	25	25	25	25
Max. radna temperatura	(°C)	80				
Max. radni pretlak	(bar)	2,6				
Polazni/povratni vod	(R)	G3/4"				
Električni grijači	(kW)	3x2	6x1,5	6x2	9x2	9x2,7
Presjek vodiča	(mm ²)	5x2,5	5x2,5	5x4	5x4	5x6
Ekspanzijska posuda	(lit.)	7				
Priključni napon	(V/Hz)	400/50				
Širina kotla	(mm)	430				
Visina kotla	(mm)	710				
Dubina kotla	(mm)	230				
Razred energetske učinkovitosti		D				



1453007	ELEKTRO KOTAO EL- CM EPLUS 6kW
1453008	ELEKTRO KOTAO EL- CM EPLUS 9kW
1453009	ELEKTRO KOTAO EL - CM EPLUS 12kW
1453010	ELEKTRO KOTAO EL - CM EPLUS 18kW
1453011	ELEKTRO KOTAO EL - CM EPLUS 24kW

SOBNA PEĆ NA PELET ZA CENTRALNO GRIJANJE CENTRO PELET ZV16-32



- 1 - Regulacija
- 2 - Glavni prekidač
- 3 - Priključak za odvod dimnih plinova
- 4 - Priključak za dovod svježeg zraka
- 5 - Polazni vod
- 6 - Povratni vod
- 7 - Poluga za čišćenje dimovodnih prolaza

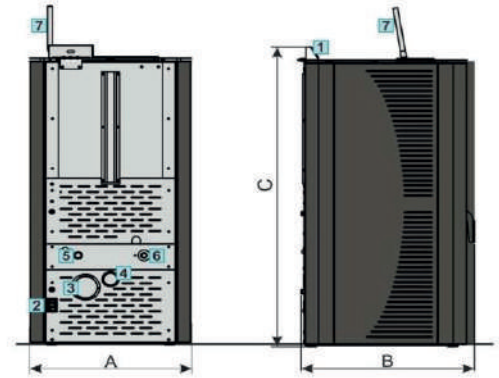

CentroPelet		ZV16	ZV20	ZV24	ZV32
Ukupni toplinski učin	kW	4,89 - 16,1	5,1 - 18,46	5,1 - 22,14	8,57 - 30,48
Toplinski učin na strani vode	kW	4,04 - 12,35	3,9 - 15,05	3,9 - 18,1	6,51 - 24,38
Toplinski učin na okolni prostor	kW	1,22 - 3,31	1,2 - 3,41	1,2 - 4,04	2,06 - 6,1
Potrošnja peleta	kg/h	1,04 - 3,46	1,08 - 4,00	1,08 - 4,80	1,82 - 6,6
Iskoristivost	%	95,9 - 94,5	94,3 - 95,4	95,4 - 93,8	95,4 - 93,8
Promjer dimovodne cijevi	Ømm	80	80	80	100
Volumen spremnika	kg	30	42	42	57
Priključak za dovod zraka	Ømm	50	50	50	60
Količina vode u peći	lit	31	50	50	60
Autonomija	h	8,5 - 29	10,5 - 39	9 - 39	8,5 - 31
Potrošnja struje pri nom. učinku	W	110 - 320	140-350	140 - 350	140-350
Razina buke (min-max)	dB	31-48	31-48	31-48	31-48
Dimenzije (A/B/C)	mm	520/630/1115	615/675/1270	615/675/1270	672/722/1384
Masa	kg	160	230	230	280

Š.Vokel	Opis
0637378	SOBNA PEĆ NA PELET ZA CENTRALNO GRIJANJE ZV-16-BIJELA
0637379	SOBNA PEĆ NA PELET ZA CENTRALNO GRIJANJE ZV-16-SIVA
0637380	SOBNA PEĆ NA PELET ZA CENTRALNO GRIJANJE ZV-16-CRVENA
0637349	SOBNA PEĆ NA PELET ZA CENTRALNO GRIJANJE ZV-20-BIJELA
0637350	SOBNA PEĆ NA PELET ZA CENTRALNO GRIJANJE ZV-20-SIVA
0637351	SOBNA PEĆ NA PELET ZA CENTRALNO GRIJANJE ZV-20-CRVENA
0637352	SOBNA PEĆ NA PELET ZA CENTRALNO GRIJANJE ZV-24-BIJELA
0637353	SOBNA PEĆ NA PELET ZA CENTRALNO GRIJANJE ZV-24-SIVA
0637354	SOBNA PEĆ NA PELET ZA CENTRALNO GRIJANJE ZV-24-CRVENA
0637355	SOBNA PEĆ NA PELET ZA CENTRALNO GRIJANJE ZV-32-BIJELA
0637356	SOBNA PEĆ NA PELET ZA CENTRALNO GRIJANJE ZV-32-SIVA
0637357	SOBNA PEĆ NA PELET ZA CENTRALNO GRIJANJE ZV-32-CRVENA

	<p>1433001</p> <p>1433002</p>	<p>DIMNA CIJEV Ø 80 x 0,5 m THERMIA</p> <p>DIMNA CIJEV Ø 80 x 1 m THERMIA</p>
	<p>1433003</p>	<p>DIMNO KOLJENO Ø 80 THERMIA</p>
	<p>1433004</p>	<p>DIMNA ROZETA Ø 80 THERMIA</p>
 <p>1433006</p> <p>1433005</p>	<p>1433005</p> <p>1433006</p>	<p>DIMNA KONDENZACIJSKA KAPA Ø 80 THERMIA</p> <p>DIMNA T-RAČVA Ø 80 THERMIA</p>

PAVIFLOOR

STIROPOR S FOLIJOM

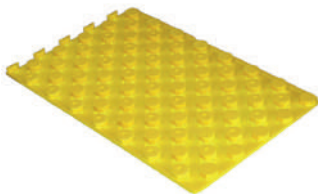

VOKEL ŠIFRA	DIMENZIJE DxŠxD (mm)	TOP. OTPORNOST m2 (K/W)	PAKIRANJE (m2)	ARTIKAL
1440002	1350x750x45	0,65	12,15	00116106
1440006	1350x750x50	0,80	10,125	00115140
1440003	1350x750x55	0,95	9,11	00114250

STIROFLOOR NEW

STIROPOR S FOLIJOM



VOKEL ŠIFRA	DIMENZIJE DxŠxD (mm)	TOP. OTPORNOST m2 (K/W)	PAKIRANJE (m2)	ARTIKAL
1440005	1200x700x43	0,75	11,76	00115001

TECKFLOOR

STIROPOR S PVC CRNOM FOLIJOM

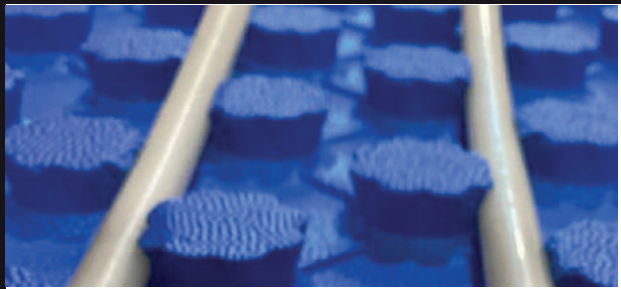
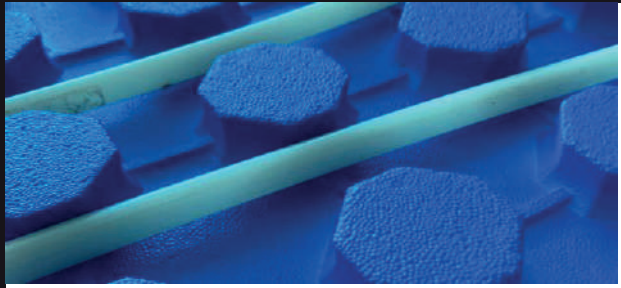

VOKEL ŠIFRA	DIMENZIJE DxŠxD (mm)	TOP. OTPORNOST m2 (K/W)	PAKIRANJE (m2)	ARTIKAL
1440001	1400x800x33	0,35	15,68	00114454
1440007	1400x800x43	0,65	11,20	00114613
1440004	1400x800x53	0,95	8,96	00114614

Šifra Vokel	Opis
 <p data-bbox="223 504 478 537">Raster polaganja cijevi 5 cm</p>	<p data-bbox="678 224 1476 280">1458001 STIROPOR S PVC FOLIJOM ALPHA H32 (10+22) CL 150 PLOČA 1400x800 mm , Pakovanje: 17,92 m² (16 Ploča).</p> <p data-bbox="678 324 1476 380">1458002 STIROPOR S PVC FOLIJOM ALPHA H42 (20+22) CL 150 PLOČA 1400x800 mm , Pakovanje: 13,44 m² (12 Ploča).</p> <p data-bbox="678 425 1476 481">1458003 STIROPOR S PVC FOLIJOM ALPHA H52 (30+22) CL 150 PLOČA 1400x800 mm , Pakovanje: 10,08 m² (9 Ploča).</p>
 <p data-bbox="223 835 478 869">Raster polaganja cijevi 5 cm</p>	<p data-bbox="678 582 1428 638">1458004 STIROPOR S FOLIJOM STAR H40 (19+21) CL 150 PLOČA 1200x800 mm , Pakovanje: 15,36 m² (16 Ploča).</p> <p data-bbox="678 728 1428 784">1458005 STIROPOR S FOLIJOM STAR H50 (29+21) CL 150 PLOČA 1200x800 mm , Pakovanje: 11,52 m² (12 Ploča).</p>
 <p data-bbox="215 1160 486 1189">Raster polaganja cijevi 7,5 cm</p>	<p data-bbox="678 985 1460 1041">1458006 STIROPOR S FOLIJOM COMFORT H58 (33+25) CL 150 PLOČA 1200x600 mm , Pakovanje: 7,20 m² (10 Ploča).</p>

SERIJA AR- multifunkcionalna za grijanje i toplu vodu

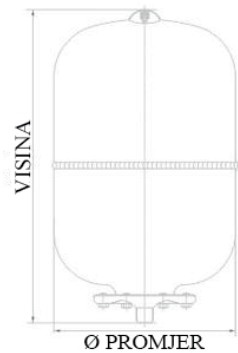

MODEL	VOKEL ŠIFRA	VISINA [mm]	PROMJER [mm]	TLAK [bar]	NAVOJ [inč]	ŠIFRA ARTIKLA
AR2	1442001	240	120	10	1/2"	AACMM00W01RE1



SERIJA VA- za toplu vodu

MODEL	VOKEL ŠIFRA	VISINA [mm]	PROMJER [mm]	TLAK [bar]	NAVOJ [inč]	ŠIFRA ARTIKLA
VA5	1442002	300	160	10	3/4"	AADVE00B01BD1
VA8	1442003	316	200	10	3/4"	AAEVE00B01BD1
VA12	1442004	295	280	10	3/4"	AAFVE00B01BD1
VA18	1442005	456	280	10	3/4"	AAGVE00B01BC1
VA24	1442006	483	280	10	1"	AAIVE00B01EC1
VA35	1442007	440	365	10	1"	AAJVE00B01EA1

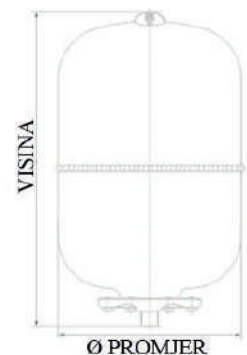

SERIJA VAV- za toplu vodu s nogarama

MODEL	VOKEL ŠIFRA	VISINA [mm]	PROMJER [mm]	TLAK [bar]	NAVOJ [inč]	ŠIFRA ARTIKLA
VAV50	1442008	697	365	10	1"	AAKVE01B01EA1
VAV100	1442009	849	495	10	1"	AANVE01B11EA1

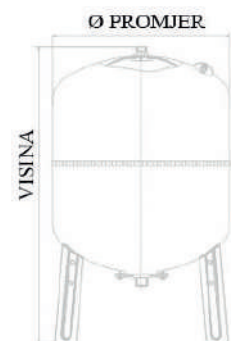



SERIJA VR- za grijanje

MODEL	VOKEL ŠIFRA	VISINA [mm]	PROMJER [mm]	TLAK [bar]	NAVOJ [inč]	ŠIFRA ARTIKLA
VR12	1442010	295	280	8	3/4"	AAFRE00R01BD1
VR18	1442011	456	280	8	3/4"	AAGRE00R01BC1
VR24	1442012	483	280	8	3/4"	AAIRE00R01DC1
VR35	1442013	440	365	8	3/4"	AAJRE00R01DA1
VR50	1442014	565	365	8	3/4"	AAKRE00R01DA1

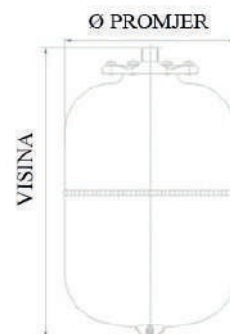

SERIJA VRV- za grijanje s nogarama

MODEL	VOKEL ŠIFRA	VISINA [mm]	PROMJER [mm]	TLAK [bar]	NAVOJ [inč]	ŠIFRA ARTIKLA
VRV35	1442015	450	365	8	3/4"	AAJRE01R01DA1
VRV50	1442016	565	365	8	3/4"	AAKRE01R01DA1
VRV80	1442017	717	415	8	1"	AAMRE01R01EA1
VRV100	1442018	663	495	8	1"	AANRE01R01EA1
VRV150	1442019	795	550	8	1"	AAPRE01R01EA1



SERIJA VRV- za grijanje s nogarama

MODEL	VOKEL ŠIFRA	VISINA [mm]	PROMJER [mm]	TLAK [bar]	NAVOJ [inč]	ŠIFRA ARTIKLA
VRV200	1442020	1085	600	8	1"	AAQRE01R21EA1
VRV250	1442021	1051	650	8	1"	AARRE01R21EA1
VRV300	1442022	1212	650	8	1"	AASRE01R21EA1

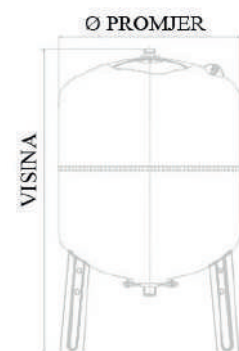

SERIJA VRV- za grijanje s nogarama



MODEL	VOKEL ŠIFRA	VISINA [mm]	PROMJER [mm]	TLAK [bar]	NAVOJ [inč]	ŠIFRA ARTIKLA
VRV750	1442029	1950	750	10	2"	AAXRH31R31GP0
VRV1000	1442030	2160	800	10	2"	AAVRH31R31GP0
VRV1500	1442031	2360	960	10	2"	AAZRH31R31GP0



SERIJA VSV- za solarni sustav s nogarama



MODEL	VOKEL ŠIFRA	VISINA [mm]	PROMJER [mm]	TLAK [bar]	NAVOJ [inč]	ŠIFRA ARTIKLA
VSV50	1442023	565	365	10	3/4"	AAKPL01W01DA1
VS18	1442027	456	280	10	3/4"	AAGPL00W01BA1

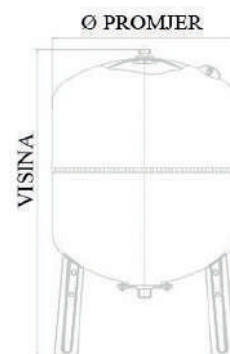

NAPOMENA: VS18 ekspanzijska posuda bez nogara

SERIJA VCP- za grijanja i bojlere



MODEL	VOKEL ŠIFRA	VISINA [mm]	PROMJER [mm]	TLAK [bar]	NAVOJ [inč]	ŠIFRA ARTIKLA
VPC387-8	1442038	85	387	3	3/8"	ZIEFD0BZA3245
VCP387-10	1442024	100	387	3	3/4"	ZIOFD0BZA33A5
VCP387-12	1442025	120	387	3	3/4"	ZIFFD0BZA33A5

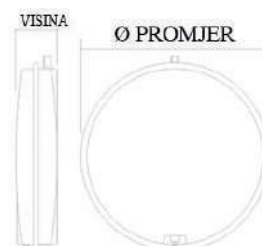

SERIJA VRP- za grijanje i bojlere



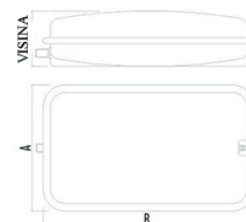

MODEL	VOKEL ŠIFRA	VISINA [mm]	DIMENZIJE [mm]	TLAK [bar]	NAVOJ [inč]	ŠIFRA ARTIKLA
VRP200-7	1442026	70	200x515	3	3/8"	ZI7GD0HZA32A5



	Š.Vokel	Opis	Jed.mj.
	0722001	PREDIZOLIRANA INOX CIJEV ZA SOLARNI SISTEM (AISI316L) 2IN2 DN16 L=10m ART.400	m
	0722002	PREDIZOLIRANA INOX CIJEV ZA SOLARNI SISTEM (AISI316L) 2IN2 DN16 L=15m ART.401	m
	0722003	PREDIZOLIRANA INOX CIJEV ZA SOLARNI SISTEM (AISI316L) 2IN2 DN16 L=20m ART.402	m
	0722004	PREDIZOLIRANA INOX CIJEV ZA SOLARNI SISTEM (AISI316L) 2IN2 DN16 L=25m ART.403	m
	0722005	PREDIZOLIRANA INOX CIJEV ZA SOLARNI SISTEM (AISI316L) 2IN2 DN20 L=10m ART.406	m
	0722006	PREDIZOLIRANA INOX CIJEV ZA SOLARNI SISTEM (AISI316L) 2IN2 DN20 L=15m ART.407	m
	0722007	PREDIZOLIRANA INOX CIJEV ZA SOLARNI SISTEM (AISI316L) 2IN2 DN20 L=20m ART.408	m
	0722008	PREDIZOLIRANA INOX CIJEV ZA SOLARNI SISTEM (AISI316L) 2IN2 DN20 L=25m ART.409	m
	0722041	SAVITLJIVA INOX CIJEV (AISI 316L) MF015 S00 DN 12 L=100m ART.419A	m
	0722018	SAVITLJIVA INOX CIJEV (AISI 316L) MF015 S00 DN 16 L=100m ART.420	m
	0722019	SAVITLJIVA INOX CIJEV (AISI 316L) MF015 S00 DN 20 L=100m ART.421	m
	0722029	SAVITLJIVA INOX CIJEV (AISI 316L) MF015 S00 DN 25 L=100m ART.422A	m
	0722037	NIKLOVANI HOLENDER 1/2" (DN12) ZA FENKOJLERE I SOLARNE SISTEME ART.419A	m
	0722036	NIKLOVANI HOLENDER 3/4" (DN16) ZA FENKOJLERE I SOLARNE SISTEME ART.430A	m
	0722035	NIKLOVANI HOLENDER 1" (DN20) ZA FENKOJLERE I SOLARNE SISTEME ART.431A	m
	0722030	NIKLOVANI HOLENDER 5/4" ZA FENKOJLERE I SOLARNE SISTEME ART.432A	Kom
	0722033	MESINGANI PUSH FIT 1" (DN25) MUŠKI ZA SOLARNE SISTEME ART.415	Kom
	0722034	MESINGANI PUSH FIT 1" (DN25) ŽENSKI ZA SOLARNE SISTEME ART.418	Kom
	0722040	MESINGANI NIPL 1/2"x1/2" ZA FENKOJLERE I SOLARNE SISTEME ART.418A	Kom
	0722011	MESINGANI NIPL 3/4"x3/4"ZA FENKOJLERE I SOLARNE SISTEME ART.450	Kom
	0722015	MESINGANI NIPL 1"x1"ZA FENKOJLERE I SOLARNE SISTEME ART.451	Kom
	0722042	MESINGANI NIPL 5/4"x5/4" ZA FENKOJLERE I SOLARNE SISTEME ART.452	Kom
	0722017	MESINGANI NIPL 3/4"x1" AN REDUCIRANI ZA FENKOJLERE I SOLARNE SISTEME ART.455	Kom

	Š.Vokel	Opis	Jed.mj.
	0722026	MESINGANA REDUKCIJA M1"-Ž3/4" ZA SOLARNE SISTEME ART.466	Kom
	0722028	MESINGANA REDUKCIJA Ž1"-M3/4" ZA SOLARNE SISTEME ART.465	Kom
	0722027	REDUKCIJA Cu 22-3/4" HOLENDER UNUTARNJI NAVOJ ZA SOLARNE SISTEME ART.467	Kom
	0722038	INOX SEGMENTNI PRSTEN ZA FLEXIBILNE INOX CIJEVI DN 12 ART.439	Kom
	0722010	INOX SEGMENTNI PRSTEN ZA FLEXIBILNE INOX CIJEVI DN 16 ART.440	Kom
	0722014	INOX SEGMENTNI PRSTEN ZA FLEXIBILNE INOX CIJEVI DN 20 ART.441	Kom
	0722031	INOX SEGMENTNI PRSTEN ZA FLEXIBILNE INOX CIJEVI DN 25 ART.442	Kom
	0722039	DIHTUNG KLINGERIT HT ZA INOX FLEXIBILNE CIJEVI DN12 (1/2") ART.459	Kom
	0722012	DIHTUNG KLINGERIT HT ZA INOX FLEXIBILNE CIJEVI DN16GR (3/4") ART.460	Kom
	0722016	DIHTUNG KLINGERIT HT ZA INOX FLEXIBILNE CIJEVI DN20GR (1") ART.461	Kom
	0722032	DIHTUNG KLINGERIT HT ZA INOX FLEXIBILNE CIJEVI DN25 (5/4") ART.462	Kom
	0722022	REZAČ FLEXIBILNIH INOX CIJEVI DO DN 25 ART.475	Kom
	0722023	ALAT ZA POVEZIVANJE FLEXIBILNIH INOX CIJEVI OD DN12 DO DN25 ART.470	Kom
	0722020	ALAT ZA PORAVNAVANJE INOX FLEXIBILNE CIJEVI DN 16 ART.476	Kom
	0722024	NASTAVAK DN16 ALATA ZA POVEZIVANJE FLEXIBILNIH INOX CIJEVI ART.472	Kom
	0722023	ALAT ZA POVEZIVANJE FLEXIBILNIH INOX CIJEVI OD DN12 DO DN25 ART.470	Kom
	0722021	ALAT ZA PORAVNAVANJE INOX FLEXIBILNE CIJEVI DN 20 ART.477	Kom
0722025	NASTAVAK DN20 ALATA ZA POVEZIVANJE FLEXIBILNIH INOX CIJEVI ART.473	Kom	

	VOKEL ŠIFRA	OPIS	ŠIFRA ARTIKLA
	1405005	ORMARIĆ PODŽBUKNI SWPSE-4 H=560, L=350	1300Z
	1405001	ORMARIĆ PODŽBUKNI SWPSE-6 H=560-660, L=450	1310Z
	1405002	ORMARIĆ PODŽBUKNI SWPSE-8/3 H=560-660, L=580	1320Z
	1405003	ORMARIĆ PODŽBUKNI SWPSE-10/7 H=560-660 L=780	1330Z
	1405004	ORMARIĆ PODŽBUKNI SWPSW-13/10 H=560-660 L=930	1340Z
	1405062	ORMARIĆ PODŽBUKNI SWPS-4 H=680-780 L=350	1300S
	1405063	ORMARIĆ PODŽBUKNI SWPS-6 H=680-780 L=450	1310S
	1405064	ORMARIĆ PODŽBUKNI SWPS-8/3 H=680-780 L=580	1320S
	1405065	ORMARIĆ PODŽBUKNI SWPS-10/7 H=680-780 L=780	1330S
	1405066	ORMARIĆ PODŽBUKNI SWPS-13/10 H=680-780 L=930	1340S
	1405072	ORMARIĆ PODŽBUKNI SLIM+ D=110-160, H=750-850 L=1200	1414183023

	1407011	RUBNA TRAKA S PREPUSTOM 8x150 (KOLUT=25 met.)	ART.0.1021
	1424076	SPOJNICA EUROKONUS ZA CIJEVI 16x2	ART.901008N
	1407012	SPOJNICA 16x2 ZA CIJEVI ZA PODNO GRIJANJE	ART.901414
	1406009	BLIND ČEP MESING G 1/2" S GUMICOM	ART.609534
	0697153 0697154 0697155 0697156	SPOJNICA, PRES KAN-therm Ø 15 SPOJNICA, PRES KAN-therm Ø 18 SPOJNICA, PRES KAN-therm Ø 22 SPOJNICA, PRES KAN-therm Ø 28	ART.6201448 ART.6201459 ART.6240058 ART.6240069
	1424077 1424078 1424079	VANJSKA OPRUGA ZA SAVIJANJE CIJEVI Ø 16 VANJSKA OPRUGA ZA SAVIJANJE CIJEVI Ø 20 VANJSKA OPRUGA ZA SAVIJANJE CIJEVI Ø 26	ART.SZ-1612 ART.SZ-2016 ART.SZ-2620
	1424080 1424081 1424082	UNUTARNJA OPRUGA ZA SAVIJANJE CIJEVI Ø 16 UNUTARNJA OPRUGA ZA SAVIJANJE CIJEVI Ø 20 UNUTARNJA OPRUGA ZA SAVIJANJE CIJEVI Ø 26	ART.SW-1612 ART.SW-2016 ART.SW-2620
	1424084 1424083	SPOJNICA UN 20x3/4" KAN THERM SPOJNICA UN 26x3/4" KAN THERM	ART.K080253 ART.K080108
	1405047 1405061	ELEKTRO POGON ZA RAZDJELNIKE (SERVO MOTOR) KAN THERM 230V ELEKTRO POGON ZA RAZDJELNIKE (SERVO MOTOR) KAN THERM 24V	ART.K800011 ART.K800013

RAZDJELNIK S MJERAČEM PROTOKA I SERVOMOTORNIM VENTILIMA

INOX, EUROKONUS 3/4"



ŠIFRA VOKEL	DIMENZIJA	BROJ IZLAZA	ART.
1479001	1"x3/4"	2	1316157066
1479002	1"x3/4"	3	1316157067
1479003	1"x3/4"	4	1316157068
1479004	1"x3/4"	5	1316157069
1479005	1"x3/4"	6	1316157070
1479006	1"x3/4"	7	1316157071
1479007	1"x3/4"	8	1316157072
1479008	1"x3/4"	9	1316157073
1479009	1"x3/4"	10	1316157074
1479010	1"x3/4"	11	1316157075
1479011	1"x3/4"	12	1316157076

RAZDJELNIK S VENTILIMA

INOX, EUROKONUS 3/4"

* Raspon protoka između 0 - 2,5 l/min

* Odgovarajući adapteri M 30x1,5



ŠIFRA VOKEL	DIMENZIJA	BROJ IZLAZA	ART.
1479017	1"x3/4"	2	1316160033
1479018	1"x3/4"	3	1316160034
1479019	1"x3/4"	4	1316160035
1479020	1"x3/4"	5	1316160036
1479021	1"x3/4"	6	1316160037
1479022	1"x3/4"	7	1316160038
1479023	1"x3/4"	8	1316160039
1479024	1"x3/4"	9	1316160040
1479025	1"x3/4"	10	1316160041
1479026	1"x3/4"	11	1316160042
1479027	1"x3/4"	12	1316160043



Završni T komad za razdjelnike - troputi

ŠIFRA VOKEL	DIMENZIJA	ART.
1405054	G1" / G½" / G½"	1300257001



Završni T komad za razdjelnike - troputi

ŠIFRA VOKEL	DIMENZIJA	ART.
1405055	G1"	1300257002



Završni inox T komad za razdjelnike - troputi

ŠIFRA VOKEL	DIMENZIJA	ART.
1479012	G1"	1300257004



Pumpa sa troputim mješajućim ventilom

ŠIFRA VOKEL	ART.
1479013	1346103005





T-komad zidni

ŠIFRA VOKEL	DIMENZIJA	PAK/KOM malo/veliko	ART.
1424112	20x1/2"	5/40	1009285057

VRTNA SLAVINA OTPORNA NA SMRZAVANJE



ŠIFRA VOKEL	DIMENZIJA	PAK/KOM malo/veliko	ART.
1424111	16	1/10	1709277001

	ŠIFRA VOKEL	OPIS	ART.
	0615195	RAZDJELNIK 1" 2 IZLAZA	662625
	0615196	RAZDJELNIK 1" 3 IZLAZA	662635
	0615197	PREMOSNICA (BY-PAS) ZA PRIMARNI DIO TERMIČKE JEDINICE	182001

	0201420	SITO ZA USISNU KORPU 4" ART.102	20/1
	0201421	NEPOVRATNI VENTIL 3/4" ART. BLOCK 101	204/12
	0201423	REGULATOR TLAKA 3/4" ART.361	44/4
	0201424	VENTIL S PRIKLJUČKOM 1/2" ART.392	160/10
	0710122	OZRAČNI LONČIĆ 3/8" ART.363	120/10
	0710123	OZRAČNI LONČIĆ 1/2" ART.363	120/10
	0696081	POKAZIVAČ TLAKA Ø 63 1/4" 0-10 bar ART.483	136/4

	0686029	RUČNI VENTIL DN15 KUTNI	ART.016102000
	0686030	RUČNI VENTIL DN15 RAVNI	ART.016202000
	0686046	PRIGUŠNICA KUTNA 3/4"	ART.35503000
	0686045	PRIGUŠNICA RAVNA 3/4"	ART.35603000
	0686044	TERMOSTATSKI VENTIL KUTNI 3/4"	ART.220103000
	0686047	TERMOSTATSKI VENTIL RAVNI 3/4"	ART.220203000
	0686038	VENTIL E-Z KUTNI ZA DVOCIJEVNI SISTEM	ART.387902000
	0686053	TERMOSTATSKI VENTIL RAVNI 1/2" S PREDNAMJEŠTANJEM	ART.345202000
	0686054	TERMOSTATSKI VENTIL KUTNI 1/2" S PREDNAMJEŠTANJEM	ART.345102000
	0686026	TERMOSTATSKA GLAVA DX	ART.670000500
	0686052	TERMOSTATSKA GLAVA D-U	ART.685200500
	0686023	TERMOSTATSKA GLAVA WK	ART.730000500

	0686037	TERMOSTATSKA GLAVA VDX	ART.674000500
	0686048	ELEKTRO MOTOR EMO T 230 V BEZ STRUJE OTVOREN	ART.183500500, 180900500
	0686051	TERMOSTATSKA GLAVA SA SENZOROM 40-70	ART.660200500
	0686025	TERMOSTATSKA GLAVA SA SENZOROM 20-50 (S podnožjem koje provodi toplinu i elementom za pričvršćivanje)	ART.640200500
	0686031	H-VENTIL DVOCJEVNI RAVNI 3/4"	ART.55250000, 56250000
	0686032	H-VENTIL DVOCJEVNI KUTNI 3/4"	ART.55350000
	0686033	SET 5 (DX GLAVA+VEKOTEC 1/2" RAVNI)	ART.DXVTECP12
	0686041	SET 7 (DX GLAVA+VEKOTEC 3/4" RAVNI)	ART.DXVTECP34
	0686040	SET 6 (DX GLAVA+VEKOTEC 1/2" KUTNI)	ART.DXVTECK12
	0686042	SET 8 (DX GLAVA+VEKOTEC 3/4" KUTNI)	ART.DXVTECK34
	0686058	SET VENTIL TERMOSTATSKI RAVNI 1/2" + DU GLAVA	ART.969618800
	0686057	SET VENTIL TERMOSTATSKI KUTNI 1/2" + DU GLAVA	ART.969617800



VOKEL ŠIFRA	OPIS	PAKIRANJE (kom)	ARTIKAL
0496004	ČEP ZA ISPITIVANJE INSTALACIJA 1/2"	50	122



VOKEL ŠIFRA	OPIS	DIMENZIJA (Ø)	PAKIRANJE (kom)	ARTIKAL
0496007	DRŽAČ CIJEVI DVOSTRANI	8x80	50	130



VOKEL ŠIFRA	OPIS	DIMENZIJA (Ø)	PAKIRANJE (kom)	ARTIKAL
0496008	DRŽAČ CIJEVI JEDNOSTRANI	8x80	50	129



VOKEL ŠIFRA	OPIS	PAKIRANJE (kom)	ARTIKAL
0496009	KONUSNO RAVNALO - KAJLA	100	136



VOKEL ŠIFRA	OPIS	DIMENZIJA (mm)	PAKIRANJE (kom)	ARTIKAL
0496011	PODLOŠKA ZA RAVNANJE	1	100	140
0496012	PODLOŠKA ZA RAVNANJE	1,6	100	135

KVALITETA / TEHNOLOGIJA / PROIZVODNJA



MADE IN ITALY

Svestran i kompletan sustav za sigurno rješenje problema na vanjskim površinama na jednostavan način i bez rušenja. Širok raspon rješenja koji odgovaraju za najveći dio problematičnih situacija koje nastaju na gradilištima te prilikom restrukturiranja postojećih situacija. Naši nosači omogućuju da odaberete najbolje rješenje ovisno o vrsti površine:

drvo, kompozitno drvo, keramika, mramor ili granit. Automatizirana proizvodnja koja osigurava maksimalnu kontrolu kvalitete, elastičnost i personalizaciju proizvoda te oprezan izbor dobavljača sirovina za inovativne proizvode, naši su novi ciljevi koji jamče kontinuirano i stalno unapređenje naših nosača

SVE PREDNOSTI SUSTAVA

Naši nosači su dizajnirani za vanjsko popločavanje s odličnim rezultatima u smislu snage i izdržljivosti. Idealno za terase, područja oko bazena, šetnice na krovovima i visećim vrtovima, može se postavljati izravno na staru podlogu.

Prednost je ogromna u smislu troškova izgradnje, rokova isporuke i nema bespotrebnih sanacija hidroizolacija jer je sustav moguće ugraditi bez rušenja.

Savršeno niveliranje završenih podova 01

Jednostavno i brzo polaganje 02

Olakšani završeni podovi 03

Pregled bez rušenja 04

Prolaz instalacija ispod poda 05

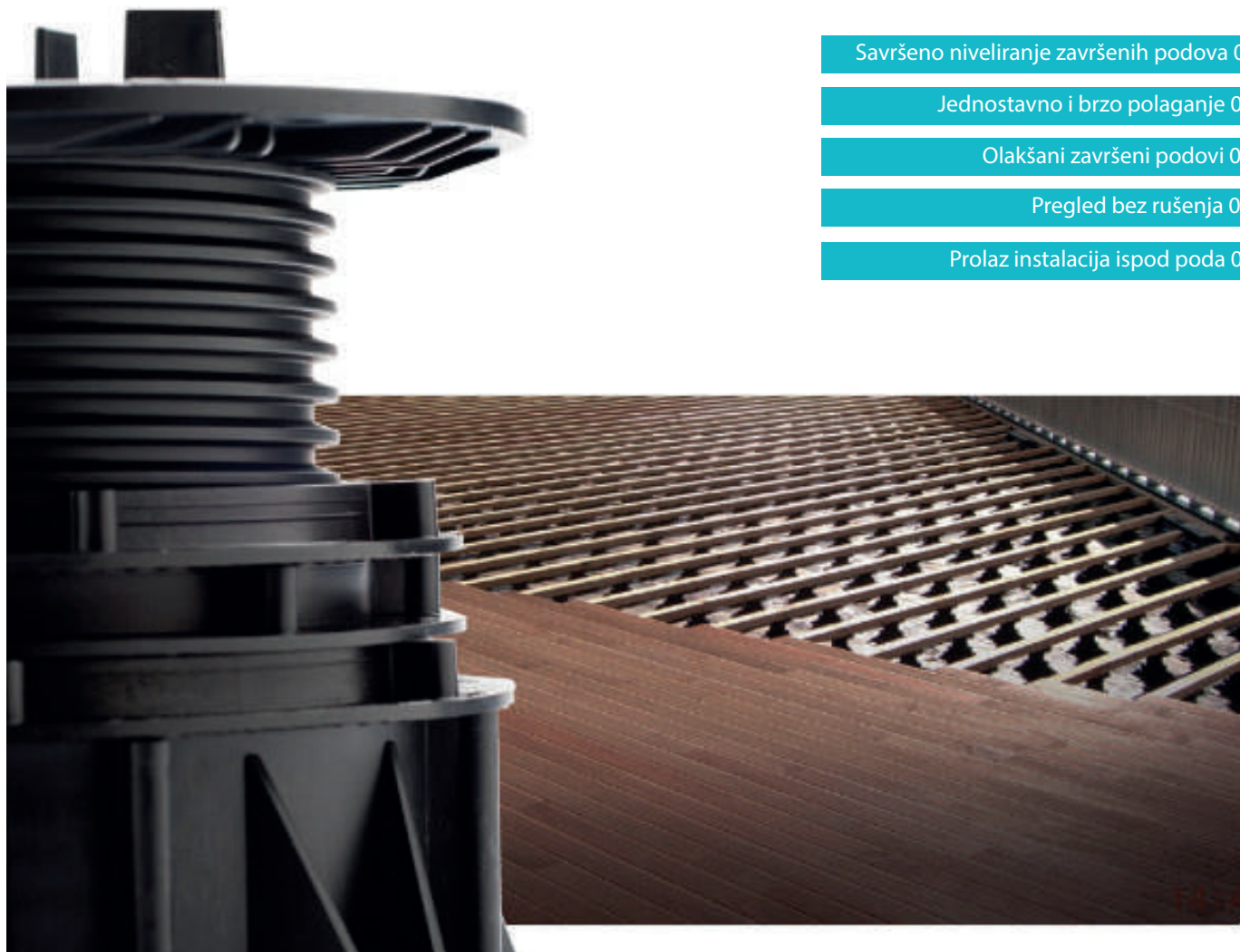

FIKSNI NOSAČI DRŽAČI FIKSNE VISINE

FIKSNI DRŽAČI koriste se za pokrivanje minimalne kvote i kada svojstva terase ne dopuštaju veće visine kao što je, na primjer, kada je prag vrata vrlo nisko.

DRŽAČI FIKSNE VISINE



MINI ELASTIČNI



Oba držača fiksne visine podržavaju sustav i podesive visine, oni omogućuju dovoljnu pokrivenost visina. Korištenje nivelira i proširenje obogaćuju ponudu, optimiziraju zalihe komada u skladištu.

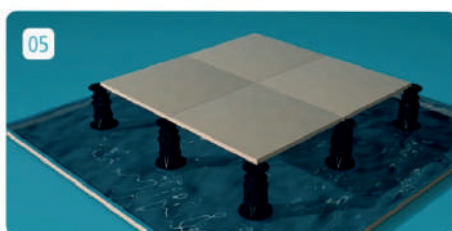
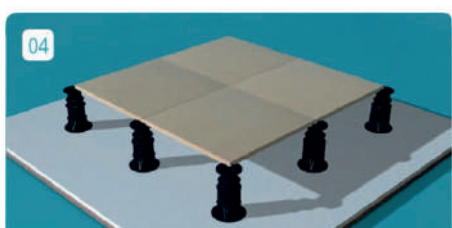
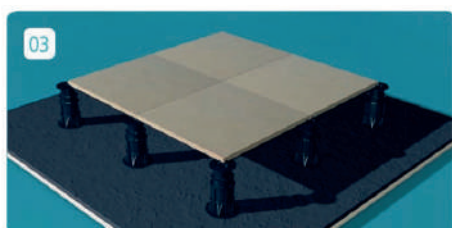
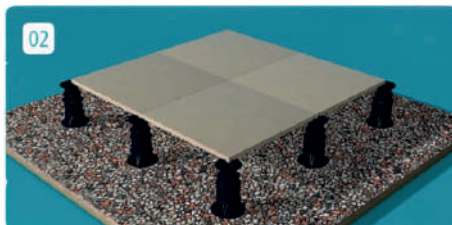
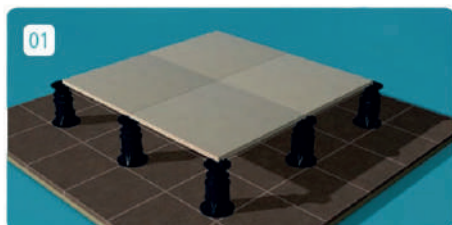

PRIMJENA DRŽAČA FIKSNE VISINE I DRŽAČA PODESIVE VISINE

- 01 Polaganje na postojeći pod
- 02 Polaganje na stabilizirani šljunak
- 03 Polaganje na bitumenske membrane
- 04 Polaganje na tekuću hidroizolaciju - sintetički filc
- 05 Polaganje za fontane i vodovode

DRŽAČI FIKSNE VISINE

ELASTIČNI DRŽAČI

Visina od 5 do 14 mm
Pun kapacitet 1000 kg/komadu

DRŽAČI FIKSNE VISINE

Visina od 12 do 19 mm
Pun kapacitet 1000kg/komadu

DRŽAČI PODESIVE VISINE

MINIMART

Visina od 22 do 37 mm
Pun kapacitet 400 kg/komadu

JACK

Visina od 35 do 365 mm
Pun kapacitet 400kg/komadu

XL JACK

Visina od 85 do 380 mm
Pun kapacitet 400 kg/komadu

MEGAMART S

Visina od 121 do 571 mm
Pun kapacitet 800kg/komadu

MEGAMART

Visina od 35 do 1020 mm
Pun kapacitet 800 kg/komadu

PODESIVI NOSAČI DRŽAČI PODESIVE VISINE

Podesivi nosači pružaju savršenu ravninu konačnog poda sa svojim jednostavnim i brzim polaganjem. Konačni rezultat je olakšani pod. To uvijek omogućava pregled i popravak bez rušenja u odnosu na standardna polaganja.

Milimetarska prilagodba u konačnici. Sustav je kompatibilan s mnogim vrstama podova: Gres pločice, montažne betonske ploče, prirodni kamen, granit drvo i kompozitno drvo.

MINIMART



JACK



XL JACK



MEGAMART S



MEGAMART



MINIMART



VOKEL ŠIFRA	OPIS	ARTIKAL
1534001	PVC REGULIRAJUĆI NOSAČI ZA PODIGNUTE PODOVE MINIMART 22-30 mm	240-626-001-022
1534002	PVC REGULIRAJUĆI NOSAČI ZA PODIGNUTE PODOVE MINIMART 28-37 mm	240-626-001-028
1534003	PVC REGULIRAJUĆI NOSAČI ZA PODIGNUTE PODOVE MINIMART 35-50 mm	240-356-300-035
1534004	PVC REGULIRAJUĆI NOSAČI ZA PODIGNUTE PODOVE MINIMART 50-70 mm	240-356-300-050
1534005	PVC REGULIRAJUĆI NOSAČI ZA PODIGNUTE PODOVE MINIMART 65-100 mm	240-356-300-065
1534006	PVC REGULIRAJUĆI NOSAČI ZA PODIGNUTE PODOVE MINIMART 95-130 mm	240-356-300-095
1534007	PVC REGULIRAJUĆI NOSAČI ZA PODIGNUTE PODOVE MINIMART 125-160 mm	240-356-300-125
1534008	PVC REGULIRAJUĆI NOSAČI ZA PODIGNUTE PODOVE MINIMART 155-190 mm	240-356-300-155
1534009	PVC REGULIRAJUĆI NOSAČI ZA PODIGNUTE PODOVE MINIMART 185-220 mm	240-356-300-185



	ŠIFRA VOKEL	OPIS	DIMENZIJE	PROTOK	ARTIKAL
	1170002	PERLATOR ZA UMIVAONIK ANTI KAMENAC, SAMOČIŠĆENJE (SLC, AC)	M24x1	13.5 - 15.0 L/Min	10850298
	1170001	PERLATOR ZA KUHINJU ANTI KAMENAC, SAMOČIŠĆENJE (SLC, AC)	M22x1	13.5 - 15.0 L/Min	10850198
	1170003	PERLATOR SSR ZA UMIVAONIK, PODEŠAVANJE KUTA PROTOKA	M24x1	13.5 - 15.0 L/Min	10753398
	1170004	PERLATOR SSR ZA KUHINJU, PODEŠAVANJE KUTA PROTOKA	M22x1	13.5 - 15.0 L/Min	10859398
	1170005	PERLATOR SIGURNOSNI ZA UMIVAONIK, PROTIV KRAĐE, SAMOČIŠĆENJE (SLC, AC)	M24x1	13.5 - 15.0 L/Min	10851198
	1170006	PERLATOR SIGURNOSNI ZA KUHINJU PROTIV KRAĐE, SAMOČIŠĆENJE (SLC, AC)	M22x1	13.5 - 15.0 L/Min	10851098
	1170007	ŠTEDNI PERLATOR SA 3-LED BOJE (zelena, žuta, crvena)	M22x1/ M24x1	7.5 L/Min	70762798
	1170008	PERLATOR ZA BATERIJE SA 3 CIJEVI, ZA PROTOČNI BOJLER	M24x1	Puni protok	10855198
	1170009	PERLATOR ZA BATERIJE SA 3 CIJEVI, ZA PROTOČNI BOJLER	M22x1	Puni protok	10855098

	ŠIFRA VOKEL	OPIS	DIMENZIJE	PROTOK	ARTIKAL
	1170010	ŠTEDNI PERLATOR ZA KUHINJU S CRIJEVOM	M22x1/ M24x1	9.5 L/Min	70324198
	1170011	REGULATOR PROTOKA PCW-02 ZA TUŠ RUČICU	M22X1/ M24X1	7 L/Min	70753098
	1170012	PERLATOR ZA KADU	M28x1	27.0 - 30.0 L/Min	02045598
	1170013	ŠTEDNI PERLATOR ZA UMIVAONIK	M24x1	8.3 L/Min	02048598
	1170014	ŠTEDNI PERLATOR ZA KUHINJU	M22x1	8.3 L/Min	02048098
	1170015	ŠTEDNI UMETAK ZA PERLATOR	M22/ M24	8.3 L/Min	02049098
	1170016	ŠTEDNI PERLATOR SA CRIJEVOM	M22x1/ M24x1	8.3 L/Min	02045998
	1170017	PERLATOR ZA KUHINJU	M22x1/ M24x1	9.5 L/Min	02046998
	1170018	PERLATOR ZA KUHINJU NARANČASTI	M22x1/ M24x1	15 L/Min	07214498

	ŠIFRA VOKEL	OPIS	DIMENZIJE	PROTOK	ARTIKAL
	1170019	PERLATOR ZA KUHINJU ZELENI	M22x1/ M24x1	15 L/Min	07214298
	1170020	PERLATOR ZA KUHINJU LJUBIČASTI	M22x1/ M24x1	15 L/Min	07215098
	1170021	PERLATOR ZA KUHINJU	M22x1	Puni protok	40502195
	1170022	PERLATOR ZA UMIVAONIK	M24x1	Puni protok	40502295
	1170023	UMETAK ZA PERLATOR	M22/ M24	Puni protok	40502395
	1170024	ŠTEDNI PERLATOR ZA UMIVAONIK ANTI KAMENAC, SAMOČIŠČENJE (SLC, AC)	M24x1	5 L/Min	02735297
	1170025	PERLATOR ZA UMIVAONIK PCA, PRSKANJE "RAIN SPRAY"	M22X1	3,8 L/Min	70589498
	1170026	ŠTEDNI PERLATOR ZA UMIVAONIK PCA, PRSKANJE "RAIN SPRAY"	M24X1	3,8 L/Min	70589598

NEOPERL® Aerators

Perlatori --- ključna komponenta svake baterije (slavine)

- o stvara mekan stabilan protok bez popratnog prskanja
- o oblikuje tok vode koja izlazi iz slavine
- o ušteda vode i smanjenje troškova energije
- o smanjenje razine buke slavine
- o u skladu sa lokalnim propisima, standardima i zakonima



Kućište



Umetak



Gumica za bateriju



Veličine i navoji



ŽENSKI M22



MUŠKI M24

MUŠKI M28
Posebno za kadu

Montaža i demontaža

Uz pomoć ključa

(pogodno za M22, M24, i M28)



Maximalna zaštita od kamenca

o **Smart lime cleaning (SLC)** za maksimalan životni vijek perlatora baterije: samo protrljate kase nac sa prstom, te je protok vode ponovno ravan i mekan !



Funkcija Automatskog Čišćenja

o **Auto - Clean funkcija (AC)** male čestice prljavštine dimenzije do 0,7 mm u vodi su jednostavno isprane !

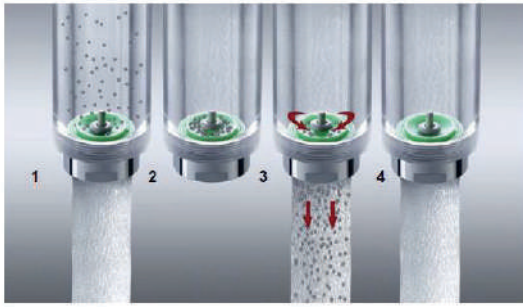

SSR Perlatori

Kut protoka vode se može direktno namjestiti na perlatoru jednostavno pomjerajući prilagodljivu nagibnu pločicu $\pm 7^\circ$



U pojedinim slučajevima umivaonici i izlaz vode na bateriji nisu proporcijalni, stoga pozicija toka vode nije idealna. Rješenje za probleme kod mnogih ne dobrih kombinacija umivaonik/baterija.

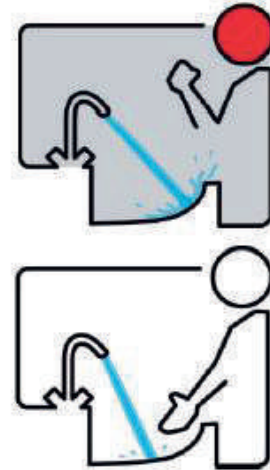

Pojedine kombinacije umivaonika i baterija proizvode prskanje vode. SSR perlator prilagođava tok vode da direktno pogodi idealnu točku bez potrebe mijenjanja umivaonika ili baterije.

PERLATOR ZA KUHINJU

Perlator za kuhinju sa 2 različita izlaza vode



Dostupno u različitim bojama



Perlator sa LED svjetlom (3 boje----- boje semafora)

- Koristeći princip boje svjetla kao kod semafora, pomaže da se voda pusti samo kada je potrebno.
- Zelena boja: za prvih 15 sekundi LED perlator svjetli u zelenoj boji
- Žuta boja: Nakon prvih 15 sekundi, led perlator postaje žut
- Crvena boja: Nakon 20 sekundi, LED perlator pocrveni i potom nakon 5 sekundi počinje da blješti



PCW02 --- UŠTEDA VODE KOD TUŠ RUČICE

- Ušteda vode za tuš ručicu, savršeno kao dodatak
- Samo zamijeniti postojeću gumicu kod tuš ručice sa PCW02. To je zatvaranje i ušteda vode u jednom.



Katalog proizvoda



NEOPERL®

flow, stop and go®



FIL-NOX
FLEX-CIJEV

VOKEL ŠIFRA	DIMENZIJA (")	DULJINA (cm)	ARTIKAL
0159001	M1/2 - H1/2	30	701030001/8204
0159002	M1/2 - H1/2	35	701035001/8204
0159003	M1/2 - H1/2	40	701040001/8204
0159004	M1/2 - H1/2	45	701045001/8204
0159005	M1/2 - H1/2	50	701050001/8204
0159006	M1/2 - H1/2	55	701055001/8204
0169007	M1/2 - H1/2	60	701060001/8204
0159008	M1/2 - H1/2	70	701070001/8204
0159009	M1/2 - H1/2	80	701080001/8204
0159010	M1/2 - H1/2	100	701100001/8240



FIL-NOX
FLEX-CIJEV

VOKEL ŠIFRA	DIMENZIJA (")	DULJINA (cm)	ARTIKAL
0159011	H1/2 - H1/2	30	701030005/8204
0159012	H1/2 - H1/2	40	701040005/8204



FIL-NOX
FLEX-CIJEV

VOKEL ŠIFRA	DIMENZIJA (")	DULJINA (cm)	ARTIKAL
0159013	H3/8 - H3/8	20	701020006/8204
0159014	H3/8 - H3/8	30	701030006/8204
0159015	H3/8 - H3/8	40	701040006/8204
0159016	H3/8 - H3/8	60	701060006/8204
0159017	H3/8 - H3/8	80	701080006/8204
0159018	H3/8 - H3/8	100	701100006/8204



FIL-NOX
FLEX-CIJEV

VOKEL ŠIFRA	DIMENZIJA (")	DULJINA (cm)	ARTIKAL
0159021	M10x1x35 - H3/8	35	721035091/8204



FIL-NOX GIG
FLEX-CIJEV

VOKEL ŠIFRA	DIMENZIJA (")	DULJINA (cm)	ARTIKAL
0159033	H1 - H1	60	004060037/8204



FIL-NOX GIG
FLEX-CIJEV

VOKEL ŠIFRA	DIMENZIJA (")	DULJINA (cm)	ARTIKAL
0159034	M1 - H1	60	004060037/8204



FIL-NOX GIG - FIL BOR
FLEX-CIJEV

VOKEL ŠIFRA	DIMENZIJA (")	DULJINA (cm)	ARTIKAL
0159043	M1 - COD01	40	004040045/8204
0159044	M1 - COD01	60	004060045/8204



FIL-NOX GIG

FLEX-CIJEV

VOKEL ŠIFRA	DIMENZIJA (")	DULJINA (cm)	ARTIKAL
0159024	H3/4 - COD03/4	30	705030021-B/R-A
0159035	H1 - COD01	40	004040046/8204
0159086	H1-COD01	60	004060046/8204



FIL-NOX GIG

FLEX-CIJEV

VOKEL ŠIFRA	DIMENZIJA (")	DULJINA (cm)	ARTIKAL
0159031	M3/8 - H3/8	10	701010002/8240
0159032	M3/8 - H3/8	20	701020002/8204
0159089	M3/8 - H3/8	30	701030002/8204
0159096	M3/8 - H3/8	40	701040002/8204
0159097	M3/8 - H3/8	50	701050002/8204
0159098	M3/8 - H3/8	60	701060002/8204



FIL-NOX

FLEX-CIJEV ZA SLAVINE

VOKEL ŠIFRA	DIMENZIJA (")	DULJINA (cm)	ARTIKAL
0159045	M10x18 - H1/2	30	721030085
0159046	M10x18 - H1/2	40	721040085
0159047	M10x18 - H1/2	50	721050085
0159048	M10x18 - H1/2	60	721060085
0159049	M10x18 - H1/2	70	721070085



FIL-NOX

FLEX-CIJEV ZA SLAVINE

VOKEL ŠIFRA	DIMENZIJA (")	DULJINA (cm)	ARTIKAL
0159050	M10x18 - H3/8	30	721030090
0159051	M10x18 - H3/8	40	721040090
0159052	M10x18 - H3/8	50	721050090
0159053	M10x18 - H3/8	60	721060090
0159054	M10x18 - H3/8	70	721070090



FIL-NOX

FLEX-CIJEV ZA SLAVINE

VOKEL ŠIFRA	DIMENZIJA (")	DULJINA (cm)	ARTIKAL
0159055	M10x35 - H1/2	30	721030086
0159056	M10x35 - H1/2	40	721040086
0159057	M10x35 - H1/2	50	721050086
0159058	M10x35 - H1/2	60	721060086
0159059	M10x35 - H1/2	70	721070086



FIL-NOX

FLEX-CIJEV ZA SLAVINE

VOKEL ŠIFRA	DIMENZIJA (")	DULJINA (cm)	ARTIKAL
0159060	M10x50 - H3/8	30	721030092
0159061	M10x50 - H3/8	40	721040092
0159062	M10x50 - H3/8	50	721050092
0159063	M10x50 - H3/8	60	721060092



FIL-NOX

FLEX-CIJEV ZA SLAVINE

VOKEL ŠIFRA	DIMENZIJA (")	DULJINA (cm)	ARTIKAL
0159064	M10x50 - H1/2	30	721030087
0159065	M10x50 - H1/2	40	721040087
0159066	M10x50 - H1/2	50	721050087
0159067	M10x50 - H1/2	60	721060087



FIL-NOX

FLEX-CIJEV ZA SLAVINE

VOKEL ŠIFRA	DIMENZIJA (")	DULJINA (cm)	ARTIKAL
0159068	M8x18 - H1/2	30	721030088
0159069	M8x18 - H1/2	40	721040088
0159070	M8x18 - H1/2	50	721050088
0159071	M8x18 - H1/2	60	721060088



FIL-NOX

FLEX-CIJEV ZA SLAVINE

VOKEL ŠIFRA	DIMENZIJA (")	DULJINA (cm)	ARTIKAL
0159072	M8x18 - H3/8	30	721030093
0159073	M8x18 - H3/8	40	721040093
0159074	M8x18 - H3/8	50	721050093
0159075	M8x18 - H3/8	60	721060093



FIL-NOX GIG

FLEX-CIJEV

VOKEL ŠIFRA	DIMENZIJA (")	DULJINA (cm)	ARTIKAL
0159088	M1/2 - H3/4	60	705060025/8204



FIL-NOX

FLEX-CIJEV S NASTAVKOM ZA KLJUČ

VOKEL ŠIFRA	DIMENZIJA (")	DULJINA (cm)	ARTIKAL
0159080	M1/2 - H1/2	30	701030001/8204A
0159081	M1/2 - H1/2	35	701035001/8204A
0159082	M1/2 - H1/2	40	701040001/8204A
0159083	M1/2 - H1/2	45	701045001/8204A
0159085	M1/2 - H1/2	50	701050001/8204A



ROZETA

ZA FLEX CIJEVI

VOKEL ŠIFRA	ARTIKAL
0159084	FLO350002



FIL-NOX GIG

FLEX-CIJEV

VOKEL ŠIFRA	DIMENZIJA (")	DULJINA (cm)	ARTIKAL
0159022	H3/4 - H3/4	30	705030029/8204
0159090	H3/4 - H3/4	50	705050029/8204
0159091	H3/4 - H3/4	70	705070029/8204
0159092	H3/4 - H3/4	100	705100029/8204



FIL-NOX GIG

FLEX-CIJEV

VOKEL ŠIFRA	DIMENZIJA (")	DULJINA (cm)	ARTIKAL
0159023	M3/4 - H3/4	30	705030026/8204
0159093	M3/4 - H3/4	50	705050026/8204
0159094	M3/4 - H3/4	70	705070026/8204
0159095	M3/4 - H3/4	100	705100026/8204



FIL-NOX

FLEX-CIJEV MATEU

VOKEL ŠIFRA	DIMENZIJA (")	DULJINA (cm)	ARTIKAL
0159019	H3/8-H1/2	30	701030007/8204
0159020	H3/8-H1/2	40	701040007/8204



TUŠ CRIJEVO

S PREKIDAČ RUČICOM

VOKEL ŠIFRA	BOJA	ARTIKAL
0159026	KROM	AQA004006



FLEX CIJEV

RASTEZLJIVA

VOKEL ŠIFRA	DIMENZIJA (cm)	ARTIKAL
0159027	150 - 190	FLE150300



PRIKLJUČNO CRIJEVO
ZA VEŠ MAŠINU

VOKEL ŠIFRA	DIMENZIJA (cm)	ARTIKAL
0159030	150	CLA201001



KOMBINIRANI KUTNI VENTIL

1/2" x 3/4" x 3/8"

- anti kamenac
- dvije ručice
- 4 nezavisne pozicije

ŠIFRA VOKEL	OPIS	ŠIFRA ARTIKLA
0309001	KOMBINIRANI KUTNI VENTIL 1/2" x 3/4" x 3/8"	COMB5MAC



PRIKLJUČAK ZA PERILICU

1/2" x 3/4"

- anti kamenac
- plavi index

ŠIFRA VOKEL	OPIS	ŠIFRA ARTIKLA
0309002	PRIKLJUČAK ZA PERILICU 1/2" x 3/4"	AC728A



KUTNI VENTIL S FILTEROM

1/2" x 3/4"

- anti kamenac
- mini filter MAC

ŠIFRA VOKEL	OPIS	ŠIFRA ARTIKLA
0309003	KUTNI VENTIL S FILTEROM 1/2" x 3/8"	02402MAC



KUTNI VENTIL

1/2" x 3/8"

- anti kamenac
- s metalnom ručicom

ŠIFRA VOKEL	OPIS	ŠIFRA ARTIKLA
0309004	KUTNI VENTIL 1/2" x 3/8"	NOV77MAC

KUTNI VENTIL DUŽI

1/2" x 3/8"



- anti kamenac
- s metalnom ručicom

ŠIFRA VOKEL	OPIS	ŠIFRA ARTIKLA
0309005	KUTNI VENTIL DUŽI 1/2" x 3/8"	NOV88MAC

KUTNI VENTIL S DVA PRIKLJUČKA

1/2" x 3/4" x 3/8"



- anti kamenac
- jedna ručica
- 4 nezavisne pozicije

ŠIFRA VOKEL	OPIS	ŠIFRA ARTIKLA
0309006	KUTNI VENTIL S DVA PRIKLJUČKA 1/2" x 3/8" x 3/8"	CQ4102

KUTNI VENTIL ZENIT

1/2" x 3/8"



- anti kamenac

ŠIFRA VOKEL	OPIS	ŠIFRA ARTIKLA
0309007	KUTNI VENTIL ZENIT 1/2" x 3/8"	Z0900

KUGLASTA SLAVINA DUPLA

1/2" x 3/4" x 3/4"



- anti kamenac
- tijelo iz jednog komada
- bez curenja

ŠIFRA VOKEL	OPIS	ŠIFRA ARTIKLA
0309008	KUGLASTA SLAVINA DUPLA 1/2" x 3/4" x 3/4"	00472

KUGLASTA SLAVINA

1/2" x 3/4"



- anti kamenac
- s metalnom ručicom

ŠIFRA VOKEL	OPIS	ŠIFRA ARTIKLA
0309009	KUGLASTA SLAVINA 1/2" x 3/4"	00413

REDUKCIJA Ž x M

1/2" x 3/4"



- anti kamenac

ŠIFRA VOKEL	OPIS	ŠIFRA ARTIKLA	PAK. (kom/kutija)
0309010	REDUKCIJA Ž 3/8" x M 1/2"	COMBI88U	20
0309011	REDUKCIJA Ž 3/8" x M 3/4"	COMBI89U	20



SLAVINA ZA PUNJENJE I PRAŽNENJE

1/2"

ŠIFRA VOKEL	OPIS	ŠIFRA ARTIKLA	PAK. (kom/kutija)
0309012	SLAVINA ZA PUNJENJE I PRAŽNENJE 1/2"	504220	35

KUTNI VENTIL LIPSTIK

1/2" x 3/8"



- ukrasni kutni ventil

ŠIFRA VOKEL	OPIS	ŠIFRA ARTIKLA
0309013	KUTNI VENTIL LIPSTIK 1/2" x 3/8"	202501

KUTNI VENTIL + FLEX CRIJEVO ZA BATERIJU

F3/8 x F3/8 30cm



- Set: kutni ventil + ukrasno flex crijevo za bateriju

ŠIFRA VOKEL	OPIS	ŠIFRA ARTIKLA
0728114	KUTNI VENTIL+FLEX CRIJEVO ZA BATERIJU F3/8 x F3/8 30cm	FVL012

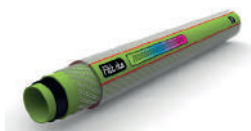

NTS LIME

CRIJEVO OTPORNO NA PREGIBANJA



VOKEL ŠIFRA	DIMENZIJA	PAKIRANJE (m)	ARTIKAL
0161034	1/2"	15	761951661559001
0161023	1/2"	25	761951662559001
0161024	1/2"	50	761951665059001
0161022	3/4"	25	761953062559001
0161025	3/4"	50	761953065059000



NTS JEANS

CRIJEVO OTPORNO NA PREGIBANJA



VOKEL ŠIFRA	DIMENZIJA	PAKIRANJE (m)	ARTIKAL
0161031	3/4"	25	761963062559001
0161035	5/8"	25	761962062559001
0161026	1/2"	25	761961662559001
0161027	1/2"	50	761961665059001



NTS ORANGE

CRIJEVO OTPORNO NA PREGIBANJA



VOKEL ŠIFRA	DIMENZIJA	PAKIRANJE (m)	ARTIKAL
0161032	1/2"	50	761991665059001
0161030	1/2"	15	761991661559001
0161033	3/4"	50	761993065059000
0161028	1/2"	25	761991662559001
0161029	3/4"	25	761993062559001

SAVRŠENA ZAŠTITA OD KAMENCA



- Štiti grijače i bubanj perilica od kamenca
- Produžuje vijek trajanja i funkcionalnost perilice
- Povećava intezitet pranja - razgrađuje organske mrlje i prljavštinu
- Čuva boju i kvalitetu rublja
- Smanjuje potrošnju sredstva za pranje
- Uz pravilnu upotrebu moguće koristiti do 10 godina.

Š.Vokel	Opis
0526175	KUGLA ZA RAZBIJANJE VODENOG KAMENCA WASHBALL ART.SWB

Uputstva za uporabu:

- Ubaciti SWISS WASH BALL zajedno sa rubljem u perilicu
- Upotrijebiti 1/3 manje sredstva za pranje od preporučene doze
- Ne upotrebljavati omekšivače vode
- SWISH WASH BALL ne treba održavanje
- SWISH WASH BALL je izdrživ do 100°C

Napomena:

Nemojte zaboraviti redovno čistiti filtere perilice a udaranje SWISH WASH BALL ne oštećuje kako bubanj tako ni rublje. Možete ga upotrebljavati kako u perilicama tako i u vodokotliću. Jednostavno stavite kuglu u košaru perilice ili je ubacite unutar vodokotlića.

Perilice rublja / Perilice posuđa / Vodokotlići



KOLJENO M-Ž

KROMIRANO



ŠIFRA VOKEL	VELIČINA ["]	ŠIFRA ARTIKLA
0203037	3/8	45138
0203038	1/2	45112
0203039	3/4	45134
0203118	1	45110

KOLJENO Ž-Ž

KROMIRANO

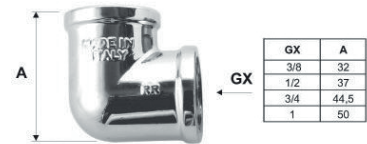

ŠIFRA VOKEL	VELIČINA ["]	ŠIFRA ARTIKLA
0203040	3/8	45238
0203041	1/2	45212
0203042	3/4	45234
0203119	1	45210

T-KOMAD

KROMIRANI

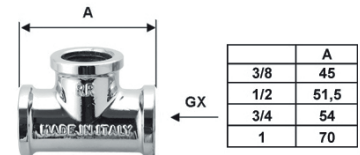

ŠIFRA VOKEL	VELIČINA ["]	ŠIFRA ARTIKLA
0203043	3/8	45338
0203044	1/2	45312
0203045	3/4	45334
0203120	1	45310

MUFNA

KROMIRANA



ŠIFRA VOKEL	VELIČINA ["]	ŠIFRA ARTIKLA
0203046	3/8	45438
0203047	1/2	45412
0203048	3/4	45434
0203121	1	45410

PRODUŽETAK 3/4"

KROMIRANI

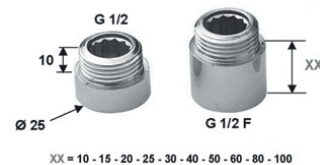

ŠIFRA VOKEL	VELIČINA ["]	ŠIFRA ARTIKLA
0203122	3/4 x 10	5023410
0203123	3/4 x 15	5023415
0203124	3/4 x 20	5023420
0203125	3/4 x 25	5023425
0203126	3/4 x 30	5023430
0203127	3/4 x 40	5023440
0203128	3/4 x 50	5023450

PRODUŽETAK 1/2"

KROMIRANI



ŠIFRA VOKEL	VELIČINA ["]	ŠIFRA ARTIKLA
0203129	1/2 x 10	502P1210
0203130	1/2 x 15	502P1215
0203131	1/2 x 20	502P1220
0203132	1/2 x 25	502P1225
0203133	1/2 x 30	502P1230
0203134	1/2 x 40	502P1240
0203135	1/2 x 50	502P1250
0203136	1/2 x 60	502P1260
0203137	1/2 x 80	502P1280
0203138	1/2 x 100	502P12100

NIPEL

KROMIRANI

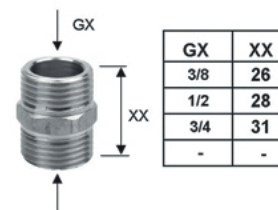

ŠIFRA VOKEL	VELIČINA ["]	ŠIFRA ARTIKLA
0203139	3/8	52038
0203140	1/2	52012
0203141	3/4	52034
0203142	1	52010

REDUKCIJA

KROMIRANA

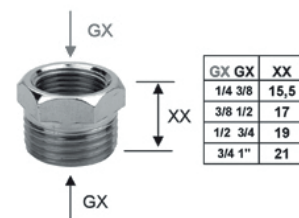

ŠIFRA VOKEL	VELIČINA ["]	ŠIFRA ARTIKLA
0203143	1/4 x 3/8	5111438
0203144	3/8 x 1/2	5113812
0203145	1/2 x 3/4	5111234
0203146	3/4 x 1	5113410

Y 3/4" F x 3/4" x 3/4"

KROMIRANI

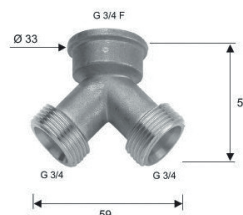

ŠIFRA VOKEL	VELIČINA ["]	ŠIFRA ARTIKLA
0203147	3/4 F x 3/4 x 3/4	209YCR

ČEP

KROMIRANI



ŠIFRA VOKEL	VELIČINA ["]	ŠIFRA ARTIKLA
0203148	3/8	52338
0203149	1/2	52312
0203150	3/4	52334
0203151	1	52310

ČEP Ž

KROMIRANI



ŠIFRA VOKEL	VELIČINA ["]	ŠIFRA ARTIKLA
0203152	3/8	52438
0203153	1/2	52412
0203154	3/4	52434
0203155	1	52410

NASTAVAK ZA SPAJANJE CRIJEVA

UNUTARNJI NAVOJ



ŠIFRA VOKEL	VELIČINA ["]	ŠIFRA ARTIKLA
0203261	½ x Ø14	532

NASTAVAK ZA SPAJANJE CRIJEVA

VANJSKI NAVOJ

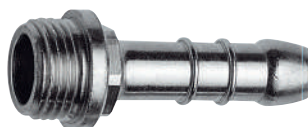

ŠIFRA VOKEL	VELIČINA ["]	ŠIFRA ARTIKLA
0203262	½ x Ø14	531

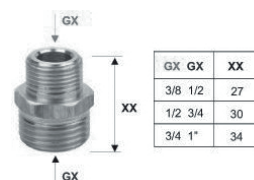
NIPEL REDUCIRANI
MESING

ŠIFRA VOKEL	VELIČINA ["]	ŠIFRA ARTIKLA
0203232	1/4 x 3/8	515OG1438
0203234	1/4 x 1/2	515OG1412
0203233	3/8 x 1/2	515OG3812
0203241	3/8 x 3/4	515OG3834
0203235	1/2 x 3/4	515OG1234
0203236	1/2 x 1	515OG1210
0203238	3/4 x 1	515OG3410
0203237	1/2 x 5/4	515OG12114
0203239	3/4 x 5/4	515OG34114
0203240	1 x 5/4	515OG1114

REDUKCIJA Ž-Ž
MESING

ŠIFRA VOKEL	VELIČINA ["]	ŠIFRA ARTIKLA
0203220	1/4 x 3/8	510OG1438
0203219	3/8 x 1/2	510OG3812
0203158	1/2 x 3/4	510OG1234
0203209	1/2 x 1	510OG1210
0203210	3/4 x 1	510OG3410
0203221	1/2 x 1 1/4	510OG12114
0203222	3/4 x 1 1/4	510OG34114
0203211	1 x 1 1/4	510OG10114

REDUKCIJA M-Ž
MESING

ŠIFRA VOKEL	VELIČINA ["]	ŠIFRA ARTIKLA
0203199	1/4 x 3/8	511OG1438
0203200	1/4 x 1/2	511OG1412
0203201	3/8 x 1/2	511OG3812
0203202	1/2 x 3/4	511OG1234
0203203	3/8 x 3/4	511OG3834
0203204	1/2 x 1	511OG1210
0203205	3/4 x 1	511OG3410
0203206	1/2 x 1 1/4	511OG12114
0203207	3/4 x 1 1/4	511OG34114
0203208	1 x 1 1/4	511OG10114

FITINZI

KOLJENO M-Ž

MESING



GX	B
3/8	39
1/2	43
3/4	50
1	57

ŠIFRA VOKEL	VELIČINA ["]	ŠIFRA ARTIKLA
0203179	3/8	451OG38
0203180	1/2	451OG12
0203181	3/4	451OG34
0203182	1	451OG10
0203183	5/4	451OG114

KOLJENO Ž-Ž

MESING



GX	B
3/8	32
1/2	37
3/4	44,5
1	50

ŠIFRA VOKEL	VELIČINA ["]	ŠIFRA ARTIKLA
0203184	3/8	452OG38
0203185	1/2	452OG12
0203186	3/4	452OG34
0203187	1	452OG10
0203188	5/4	452OG114

T-KOMAD

MESING

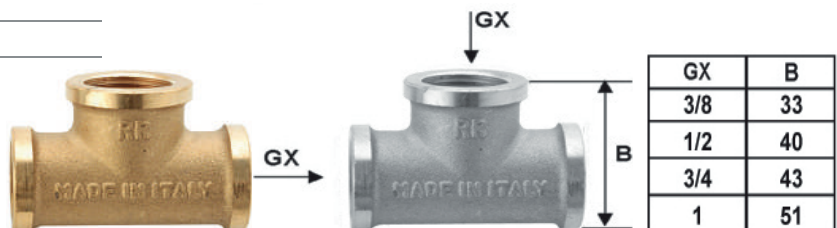

GX	B
3/8	33
1/2	40
3/4	43
1	51

ŠIFRA VOKEL	VELIČINA ["]	ŠIFRA ARTIKLA
0203189	3/8	453OG38
0203190	1/2	453OG12
0203191	3/4	453OG34
0203192	1	453OG10
0203193	5/4	453OG114

MUFNA

MESING



GX
3/8
1/2
3/4
1

ŠIFRA VOKEL	VELIČINA ["]	ŠIFRA ARTIKLA
0203194	3/8	454OG38
0203195	1/2	454OG12
0203196	3/4	454OG34
0203197	1	454OG10
0203198	5/4	454OG114

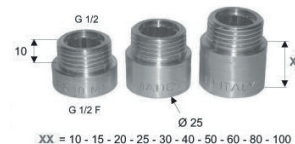
PRODUŽETAK
MESING

ŠIFRA VOKEL	VELIČINA	ŠIFRA ARTIKLA
0203175	1" x 15 mm	502OG1015
0203176	1" x 20 mm	502OG1020

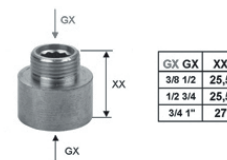
PRODUŽETAK-REDUKCIJA
MESING

ŠIFRA VOKEL	VELIČINA ["]	ŠIFRA ARTIKLA
0203224	1/4 x 3/8	506OG1438
0203212	1/4 x 1/2	506OG1412
0203213	3/8 x 1/2	506OG3812
0203214	3/8 x 3/4	506OG3834
0203215	1/2 x 3/4	506OG1234
0203216	1/2 x 1	506OG1210
0203217	3/4 x 1	506OG3410
0203225	5/4 x 1/2	506OG12114
0203223	3/4 x 5/4	506OG34114
0203218	1 x 5/4	506OG10114

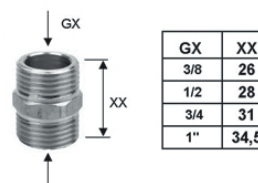
NIPLO
MESING

ŠIFRA VOKEL	VELIČINA ["]	ŠIFRA ARTIKLA
0203226	3/8	520OG38
0203227	1/2	520OG12
0203228	3/4	520OG34
0203229	1	520OG10
0203230	5/4	520OG54

SPOJNICA S ČEPOM
MESING

ŠIFRA VOKEL	VELIČINA ["]	ŠIFRA ARTIKLA
0203177	1/2	47112
0203178	3/4	47134

SPOJNICA

VANJSKI NAVOJ



ŠIFRA VOKEL	VELIČINA	ŠIFRA ARTIKLA
0203159	1/2" x 16 mm	495RM1216
0203244	1/2" x 20 mm	495RM1220
0203246	3/4" x 20 mm	495RM3420

SPOJNICA

UNUTARNJI NAVOJ



ŠIFRA VOKEL	VELIČINA	ŠIFRA ARTIKLA
0203173	1/2" x 16 mm	495RF1216
0203249	1/2" x 20 mm	495RF1220

SPOJNICA



ŠIFRA VOKEL	VELIČINA [mm]	ŠIFRA ARTIKLA
0203160	16 x 16	495RD1616
0203255	16 x 20	495RD1620
0203256	20 x 20	495RD2020



KALIBRATOR

Ø 16, 20, 26, 32

ŠIFRA VOKEL	Ø[mm]	ŠIFRA ARTIKLA
0203242	16, 20, 26, 32	495SB



KLIJEŠTA

ŠIFRA VOKEL	ŠIFRA ARTIKLA
0203243	495 CE

SET

HIGIJENSKI KOMPLET SA SIGURNOSNIM ZATVARANJEM SA TUŠ RUČICOM I CRIJEVOM ZA HLADNU VODU

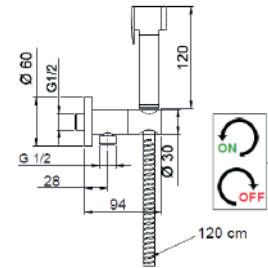

ŠIFRA VOKEL	Ø[mm]	ŠIFRA ARTIKLA
0203264		338 M 332 OW

SET

HIGIJENSKI KOMPLET TOPLA/HLADNA VODA SA SIGURNOSNIM ZATVARANJEM (CRIJEVO + RUČICA)

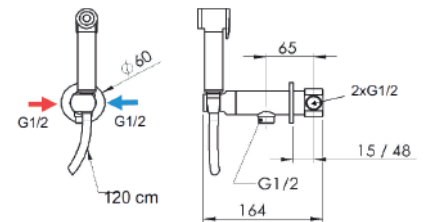

ŠIFRA VOKEL	Ø[mm]	ŠIFRA ARTIKLA
0203265	60	N64W

M100i Višemlazni vodomjer



Š.Vokel	Opis
0135024	VODOMJER IKOM M100i 1/2" DN 15 BEZ SPOJNICA INDUKTIVNI - PRIPREMLJEN ZA DALJINSKO OČITAVANJE
0135025	VODOMJER IKOM M100i 3/4" DN 20 BEZ SPOJNICA INDUKTIVNI - PRIPREMLJEN ZA DALJINSKO OČITAVANJE
0135026	VODOMJER IKOM M100i 1" DN 25 BEZ SPOJNICA INDUKTIVNI - PRIPREMLJEN ZA DALJINSKO OČITAVANJE
0135027	VODOMJER IKOM M100i 5/4" DN 32 BEZ SPOJNICA INDUKTIVNI - PRIPREMLJEN ZA DALJINSKO OČITAVANJE
0135028	VODOMJER IKOM M100i 6/4" DN 40 BEZ SPOJNICA INDUKTIVNI - PRIPREMLJEN ZA DALJINSKO OČITAVANJE
0135029	VODOMJER IKOM M100i 2" DN 50 BEZ SPOJNICA INDUKTIVNI - PRIPREMLJEN ZA DALJINSKO OČITAVANJE

Osnovna svojstva:

- Višemlazni mokri vodomjer DN15-DN50 s navojnim spojem i horizontalnim kućištem
- Klasa točnosti C (R=160) u horizontalnom položaju i B (R=80) u vertikalnom položaju
- Induktivna kazaljka
- Vodomjer za hladnu vodu do 50°C
- Vodomjer može biti potopljen: IP68 zaštita
- Opcija: Vodomjer s vertikalnim kućištem koji ima klasu točnosti C (R=160)
- Dodatne opcije: Nepovratni ventil i sito

Mogućnost nadogradnje pulsno izlaza i radio modula:

- Kompatibilan s impulsnim izlazom: FALCON MJ
- Kompatibilan s radio modulom : MERLIN MJ 868

Elster H-4000 Woltmann turbinski vodomjer



Š.Vokel	Opis
0135030	VODOMJER INDUSTRIJSKI ELSTER H4000 DN 50 PRIPREMLJEN ZA DALJINSKO OČITAVANJE
0135031	VODOMJER INDUSTRIJSKI ELSTER H4000 DN 65 PRIPREMLJEN ZA DALJINSKO OČITAVANJE
0135032	VODOMJER INDUSTRIJSKI ELSTER H4000 DN 80 PRIPREMLJEN ZA DALJINSKO OČITAVANJE
0135033	VODOMJER INDUSTRIJSKI ELSTER H4000 DN 100 PRIPREMLJEN ZA DALJINSKO OČITAVANJE

Osnovna svojstva:

- Woltmann turbinski vodomjer DN40-DN300
- Izmjenjiv mjerni uložak na licu mjesta, bez potrebe za skidanje kućišta
- Mogućnost ugradnje u svim položajima bez gubitaka deklarirane klase točnosti
- Vodomjer može biti potopljen: IP68 zaštita

Mogućnost nadogradnje pulsno izlaza i radio modula:

- Kompatibilan s impulsnim izlazom: Pr7
- Kompatibilan s radio modulom : MERLIN 868

ITAP - Spojnice za vodomjere



Š.Vokel	Opis
0150033	SPOJNICA ZA VODOMJER 3/4"x 1/2" ART.154
0150034	SPOJNICA ZA VODOMJER 1"x 3/4" ART.154
0150035	SPOJNICA ZA VODOMJER 1 1/4"x 1" ART.154
0150036	SPOJNICA ZA VODOMJER 1 1/2"x 1 1/4" ART.154
0150037	SPOJNICA ZA VODOMJER 2"x 1 1/2" ART.154
0150038	SPOJNICA ZA VODOMJER 2 1/2"x 2" ART.154

V200H Volumetrijski hibridni vodomjer DN15-DN40



Š.Vokel	Opis
0135034	ELEKTRONIČKI VODOMJER IKOM V200H 3/4" DN 20, SA INTEGRIRANIM RADIJSKIM MODULOM ZA DALJINSKO OČITANJE

Osnovna svojstva:

- Volumetrijski klipni vodomjer s elektroničkim brojiлом i integriranim radijskim modulom
- Dimenzije DN 15 i DN 20 su dostupne i u izvedbi s polimernim tijelom i navojem od mesinga
- Klasa zaštite IP 68
- Viskoka točnost (do R400 za DN15 i Dn20)
- Frekvencija 868 Mhz
- Radna temperatura: -10°C do +55°C
- Integrirani radio modul s protokolom WMBus po OMS standardu, te s AES enkripcijom podataka
- Slanje podataka vrši se svakih 10 sekundi (podesivo)
- Snaga odašiljanja: 25 mW
- Alarmi: povratni protok, curenje, pucanje cijevi, slaba baterija, nema protoka
- Životni vijek baterije 15 godina

AKUMULACIJSKI SPREMNICI / BOJLERI

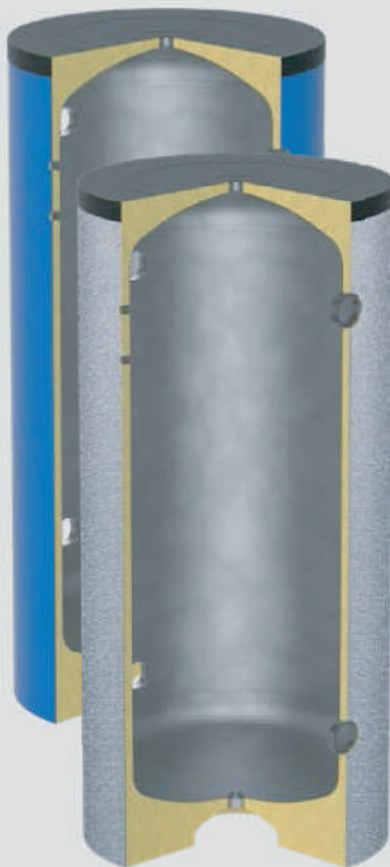
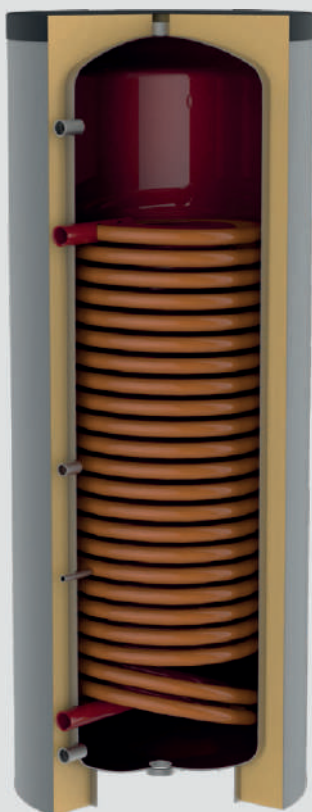

fiorini

AKUMULACIJSKI SPREMNICI MINI-HC (Puffer)

MINI-HC serija uključuje spremnike za postrojenja GRIJANJA i HLAĐENJA - MONTAŽA SAMO NA ZID

Materijal: ugljični čelik

Vanjska obloga: obojeni pocinčani metalni lim, bijela boja

Izolacija

Kapacitet (l)	Tip
40, 80	Kruta poliuretanska pjena visoke gustoće

Radna ograničenja

Min. temperatura	Max. temperatura	Max. tlak
-10 °C	90 °C	6 bar

Kapacitet l	MINI montaža na zid		Energetski razred	Dimenzije cm	Težina kg
	Artikal	Šifra Vokel			
40	817010175X	1457015	B	50x50x50	25
80	817010176X	1457001	B	50x50x100	35



TESTED

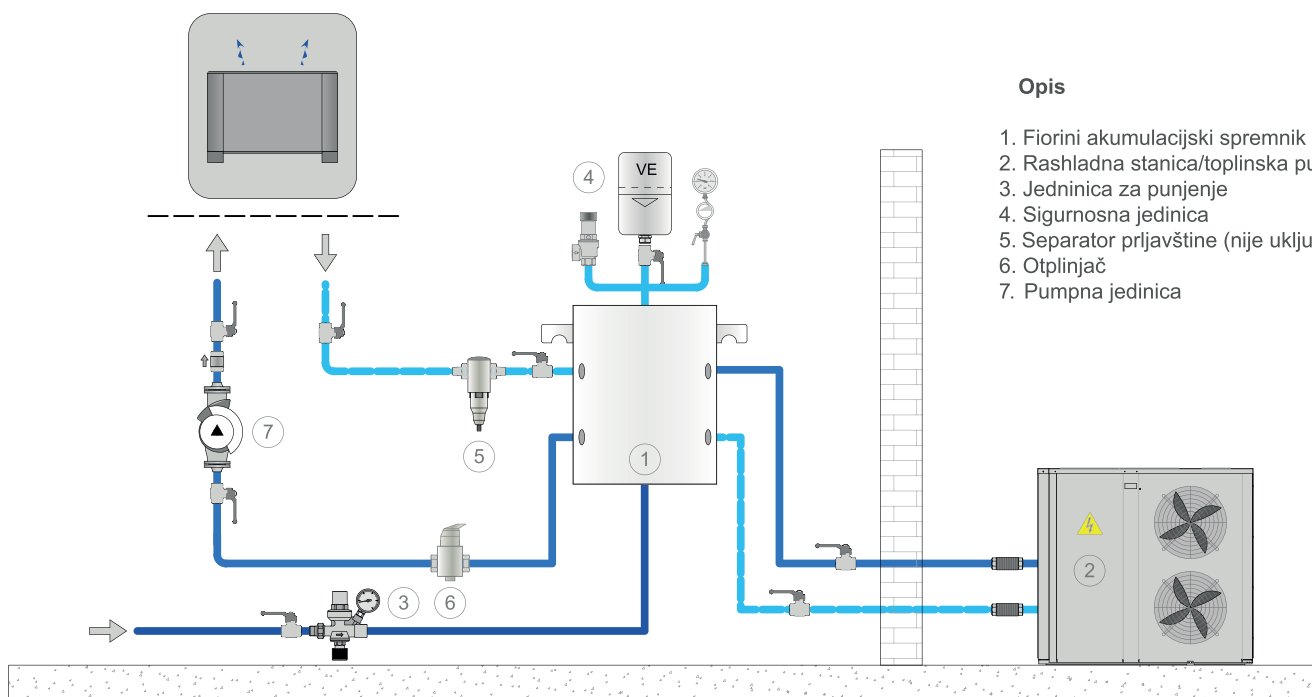

Opis

1. Fiorini akumulacijski spremnik
2. Rashladna stanica/toplinska pumpa
3. Jedinica za punjenje
4. Sigurnosna jedinica
5. Separator prljavštine (nije uključen)
6. Otplinjač
7. Pumpna jedinica

cap. = 40

cap. = 80

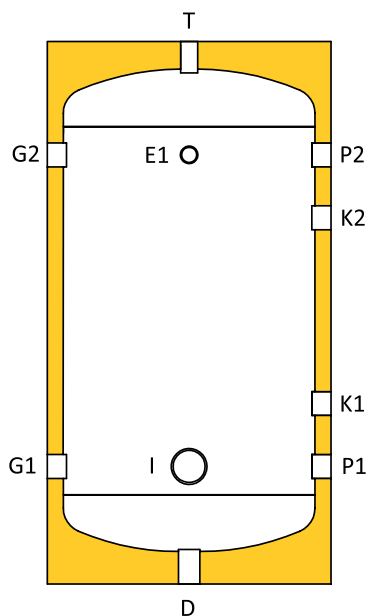
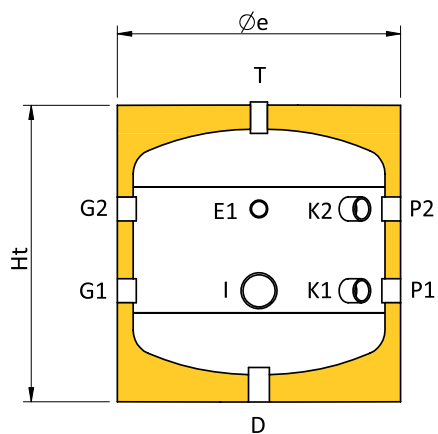

Opis

D	Pražnjenje
E1	Kapilarna cijev za osjetnike
G1	od postrojenja
G2	do postrojenja
I	Električni grijač
K1	prema izvoru energije
K2	od izvora energije
P1	prema izvoru energije
P2	od izvora energije
T	otvor

Spojnice

Kapacitet l	D inch	E inch	G1 inch	G2 inch	I inch	K1 inch	K2 inch	P1 inch	P2 inch	T inch
40	3/4"	1/2"	1"	1"	1 1/2"	1"	1"	1"	1"	1/2"
80	3/4"	1/2"	1"	1"	1 1/2"	1"	1"	1"	1"	1/2"

Dimenzije

Kapacitet l	Øe mm	Ht mm	R* mm	E mm	G1 mm	G2 mm	I mm	K1 mm	K2 mm	P1 mm	P2 mm
40	460	477	663	307	177	307	177	177	307	177	307
80	460	862	978	682	187	682	187	287	582	187	682

R*: Povratna kvota

VKG akumulacijski spremnici (Puffer)

VKG serija uključuje akumulacijske spremnike za hladnu i toplu vodu od -10°C do 60°C

Materijal: ugljični čelik

Vanjska obloga

Model	Tip	Korištenje
VKG	obojeni PVC	unutra
VKGE	reljefni aluminijski lim	vani

1
2

Izolacija

Kapacitet (l)	Tip	Debljina. (mm)
od 100 do 1000	Kruta poliuretanska pjena visoke gustoće	30
od 1500 + horizontalna verzija	Poliuretanska pjena zatvorene ćelije	20

Radna ograničenja

Min temperatura	Max temperatura	Max tlak
-10 °C	60 °C	6 bar



Kapacitet l	VKG vertikalni, PVC obojeni		VKGE vertikalni, reljefni aluminijski lim		Vertikalno pakiranje		VKG horizontalni, PVC obojeni	
	Artikal	Šifra Vokel	Artikal	Šifra Vokel	Dimenzije cm	Težina kg	Artikal	Šifra Vokel
100	816010130	1457002	816011275H8X		49x49x107	24	816010142	
200	816010131	1457003	816011276H8X		54x54x145,5	36	816010143	
300	816010132	1457005	816011277H8X		64x64x154,5	46	816010144	
500	816010133	1457004	816011278H8X		74x74x183,5	78	816010145	
800	816010134	1457013	816011279H8X		88x88x186	105	816010146	
1000	816010135	1457014	816011280H8X		94x94x214,6	129	816010147	
1500	816010136				107x107x228	182	816010148	
2000	816010137				117x117x260	250	816010149	
2500	816010138				132x132x239,5	267	816010150	
3000	816010139				132x132x289,5	314	816010151	
4000	816010140				147x147x296,5	470	816010152	
5000	816010141				167x167x300,5	557	816010153	
6000	816011186X				282x203x204	647		
8000	816011187X				352x203x204	782		
10000	816011188X				427x203x204	927		

VKG akumulacijski spremnici (Puffer)

1500 ≤ cap. ≤ 5.000

6000 ≤ cap. ≤ 10.000

Opis

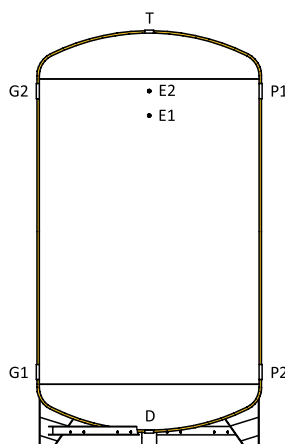
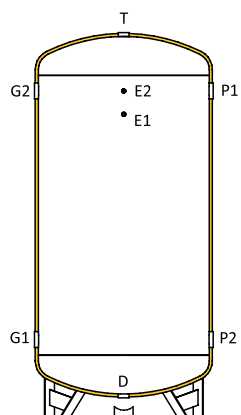
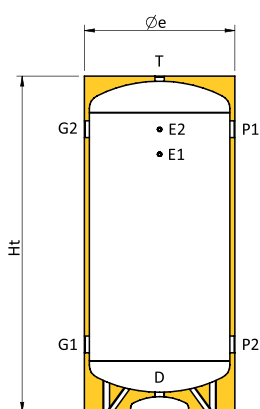

- D Pražnjenje
- E1 Kapilarna cijev za osjetnike
- E2 Kapilarna cijev za osjetnike
- G1 od postrojenja
- G2 do postrojenja
- P1 prema izvoru energije
- P2 od izvora energije
- T Otvor

Dimenzije i sponice za vertikalnu verziju

Kap. l	Øe mm	Ht mm	R* mm	D mm	E1 mm	E2 mm	G1 mm	G2 mm	P1 mm	P2 mm	D inch	E1 inch	E2 inch	G1 inch	G2 inch	P1 inch	P2 inch	T inch
100	460	950	1060	125	610	760	290	760	760	290	1"1/4	1/2"	1/2"	1"1/2	1"1/2	1"1/2	1"1/2	1"1/4
200	510	1335	1430	120	990	1140	290	1140	1140	290	1"1/4	1/2"	1/2"	1"1/2	1"1/2	1"1/2	1"1/2	1"1/4
300	610	1425	1550	130	1015	1165	365	1165	1165	365	1"1/4	1/2"	1/2"	2"	2"	2"	2"	1"1/4
500	710	1710	1855	135	1285	1435	385	1435	1435	385	1"1/4	1/2"	1/2"	3"	3"	3"	3"	1"1/4
800	850	1740	1940	125	1295	1445	395	1445	1445	395	1"1/2	1/2"	1/2"	3"	3"	3"	3"	1"1/2
1000	910	2025	2220	120	1560	1710	410	1710	1710	410	1"1/2	1/2"	1/2"	3"	3"	3"	3"	1"1/2
1500	1040	2160	2400	165	1650	1800	500	1800	1800	500	2"	1/2"	1/2"	3"	3"	3"	3"	2"
2000	1140	2480	2730	155	1955	2105	505	2105	2105	505	2"	1/2"	1/2"	3"	3"	3"	3"	2"
2500	1290	2275	2620	180	1715	1865	565	1865	1865	565	2"	1/2"	1/2"	4"	4"	4"	4"	2"
3000	1290	2775	3060	180	2215	2365	565	2365	2365	565	2"	1/2"	1/2"	4"	4"	4"	4"	2"
4000	1440	2845	3190	160	2240	2390	590	2390	2390	590	2"	1/2"	1/2"	4"	4"	4"	4"	2"
5000	1640	2885	3320	140	2250	2400	600	2400	2400	600	2"	1/2"	1/2"	4"	4"	4"	4"	2"
6000	1840	2715	3280	140	2015	2215	615	2215	2215	615	2"	1/2"	1/2"	4"	4"	4"	4"	2"
8000	1840	3415	3880	140	2715	2915	615	2915	2915	615	2"	1/2"	1/2"	4"	4"	4"	4"	2"
10000	1840	4165	4555	140	3465	3665	615	3665	3665	615	2"	1/2"	1/2"	4"	4"	4"	4"	2"

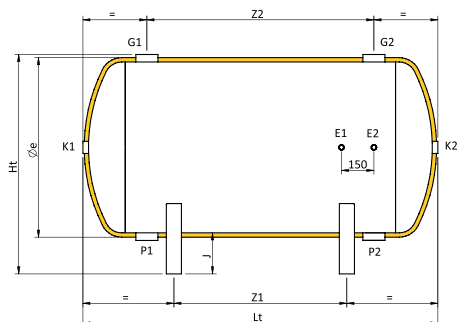

Opis

- E1 Kapilarna cijev za osjetnike
- E2 Kapilarna cijev za osjetnike
- G1 od postrojenja
- G2 do postrojenja
- K1 otvor
- K2 otvor
- P1 prema izvoru energije
- P2 od izvora energije

Dimenzije i spojnice za horizontalnu verziju

Kap. l	Øe mm	Lt mm	Ht mm	J mm	Z1 mm	Z2 mm	E1 inch	E2 inch	G1 inch	G2 inch	K1 inch	K2 inch	P1 inch	P2 inch
100	440	850	545	120	310	470	1/2"	1/2"	1"1/2	1"1/2	1"1/4	1"1/4	1"1/2	1"1/2
200	490	1240	595	120	700	850	1/2"	1/2"	1"1/2	1"1/2	1"1/4	1"1/4	1"1/2	1"1/2
300	590	1320	715	140	600	800	1/2"	1/2"	2"	2"	1"1/4	1"1/4	2"	2"
500	690	1600	865	190	900	1050	1/2"	1/2"	3"	3"	1"1/4	1"1/4	3"	3"
800	830	1640	1005	190	900	1050	1/2"	1/2"	3"	3"	1"1/2	1"1/2	3"	3"
1000	890	1930	1065	190	1130	1300	1/2"	1/2"	3"	3"	1"1/2	1"1/2	3"	3"
1500	1040	2020	1215	190	950	1300	1/2"	1/2"	3"	3"	2"	2"	3"	3"
2000	1140	2350	1325	200	1320	1600	1/2"	1/2"	3"	3"	2"	2"	3"	3"
2500	1290	2120	1500	225	1020	1300	1/2"	1/2"	4"	4"	2"	2"	4"	4"
3000	1290	2620	1500	225	1390	1800	1/2"	1/2"	4"	4"	2"	2"	4"	4"
4000	1440	2710	1650	225	1380	1800	1/2"	1/2"	4"	4"	2"	2"	4"	4"
5000	1640	2770	1850	225	1380	1800	1/2"	1/2"	4"	4"	2"	2"	4"	4"

R*: Povratna kvota

Bojleri za toplinske pumpe – SMART HP

Paleta HP proizvoda sastoji se od bojlera za proizvodnju tople vode za kućanstva s dvostrukim spiralnim izmjenjivačem s velikom površinom za spajanje sa toplinskom pumpom. Bojleri su dostupni u nekoliko kapaciteta, od 300 do 1000 l i izolirani su krutim poliuretanom visoke gustoće, izvana prekriven PVC-om i zaštićen s magnezijevom anodom radi zaštite od galvanskih struja i inspeksijskom prirubnicom za lak pristup tijekom faze održavanja.

Materijal: S 235 JR ugljični čelik

Tretman za unutrašnju zaštitu:

Emajliran proizvod prema normi DIN 4753.3

Izolacija

Kapacitet (l)	Tip
od 300 do 1000	Kruta poliuretanska pjena visoke gustoće

Radna ograničenja

Skladištenje		Primarni krug	
max. temperatura	max. tlak	max. temperatura	max. tlak
95°C	10 bar	110°C	12 bar



Podesive nogare, sigurnosni ventil i termometar, magnezijeva zaštitna anoda

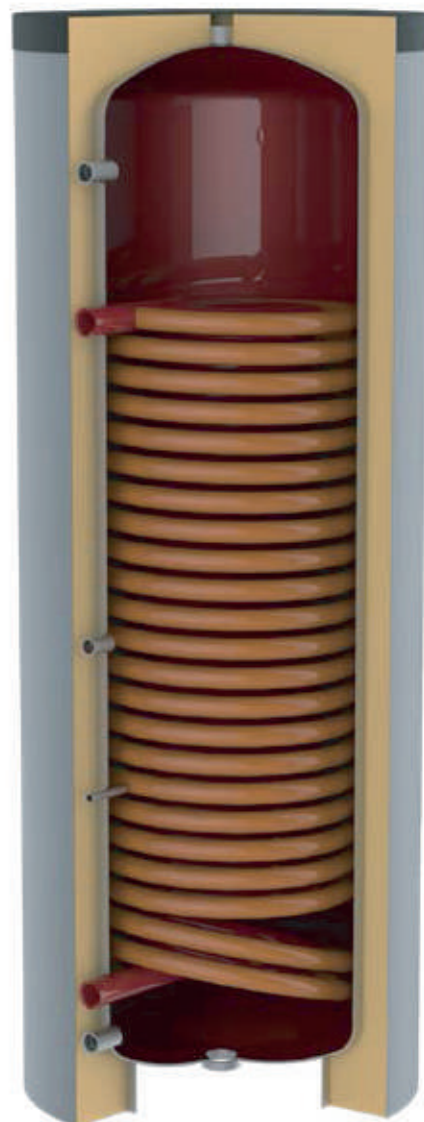

TESTED

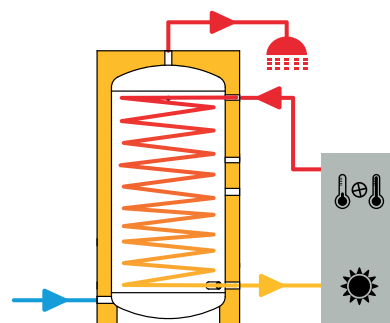

Kapacitet l	Artikal	Šifra Vokel	Energetski razred	Vertikalno pakiranje	
				Dimenzije cm	Težina kg
300	819060121X	1457006	B	75x75x168	177
500	819060123X	1457007	C	75x75x204	239
750	819060124X		C	90x90x207	318
1000	819060125X		C	110x110x198	409

Bojleri za toplinske pumpe – SMART HP

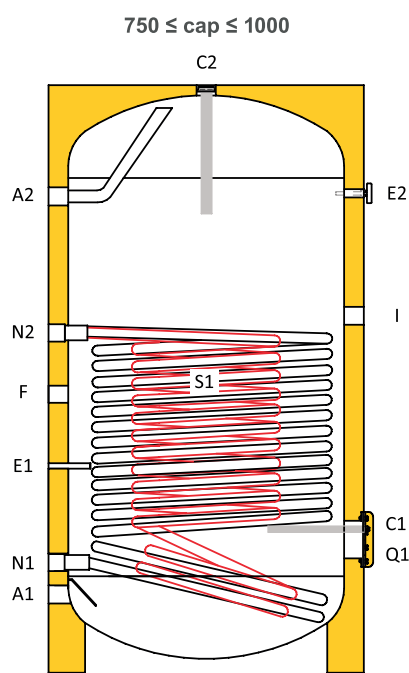
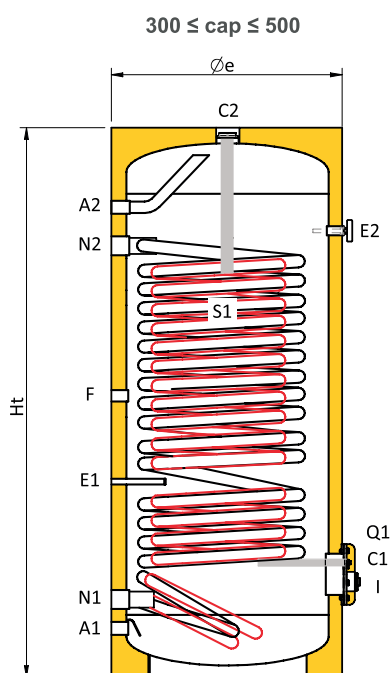

Opis

A1	ulaz tople vode
A2	izlaz tople vode
C1	Anoda
C2	Anoda
E1	Kapilarna cijev za osjetnike
E2	Kapilarna cijev za osjetnike
F	Recirkulacija
I	Električni grijač
N1	Donji solarni izlaz izmj.
N2	Donji solarni ulaz izmj.
Q1	Inspeksijska prirubnica
S1	Donji izmjenjivač

Spojnice

Kap. l	A1 inch	A2 inch	C1 mm	C2 inch	E1 inch	E2 mm	F inch	I inch	N1 inch	N2 inch	Q1 (Øext/Øint) mm
300	1"	1"	M8	1 1/4	3/8"x90	1/2"	3/4"	1 1/2	1 1/4	1 1/4	Ø180/Ø120
500	1"	1"	M8	1 1/4	3/8"x120	1/2"	3/4"	1 1/2	1 1/4	1 1/4	Ø180/Ø120
750	1 1/2	1 1/2	M8	2"	3/8"x140	1/2"	1 1/4	1 1/2	1 1/4	1 1/4	Ø280/Ø205
1000	1 1/2	1 1/2	M8	2"	3/8"x160	1/2"	1 1/4	1 1/2	1 1/4	1 1/4	Ø280/Ø205

Dimenzije

Kap. l	Øe mm	Ht mm	R* mm	A1 mm	A2 mm	E1 mm	E2 mm	F mm	I mm	N1 mm	N2 mm	Q1** mm
300	670	1615	1750	130	1355	550	1295	765	-	220	1035	290
500	750	1950	2090	180	1650	610	1580	870	-	265	1415	340
750	855	2050	2225	215	1715	755	1725	1175	1425	395	1355	445
1000	1055	1960	2230	247	1567	747	1577	1077	1277	447	1197	497

R*: Povratna kvota Q1**: Visina od inspeksijske prirubnice do poda

Bojleri za toplinske pumpe – SMART HP

Kapacitet l	Ti °C	Proizvodnja tople vode TiDHW = 10°C			Izmjenjivač	
		TuDHW= 45°C		Ta = 50°C TuDHW = 45°C	Površina m ²	Protok mk/h
		l/h (a)	kW (b)	l/10 min. (e)		
300	50	688	28	433	3,8	4,0
	80	2236	91	691		
500	50	958	39	691	6	4,0
	80	2432	99	937		
750	50	982	40	961	6,5	4,0
	80	3390	138	1362		
1000	50	982	40	1227	6,5	4,0
	80	3390	138	1628		

- kontinuirani protok vode sa TuACS=45°C
- snaga izmjenjivača s TuACS=45°C
- vrijednost tople vode na 45°C u prvih 10 min sa skladišnom temperaturom od 50°C
- kapacitet izmjenjivača : 7.10 Lt/mq

Opis

- 1 Spremnik tople vode
- 2 Magnzijska anoda
- 3 toplinska pumpa / dodatni izvor
- 4 temp.sonde tople vode
- 5 bakteriostatski filter hladne vode
- 6 Recirkulacijska pumpa
- 7 Termostatski mješač tople vode
- 8 Sigurnosna grupa
- 9 Električni grijač (opcija)

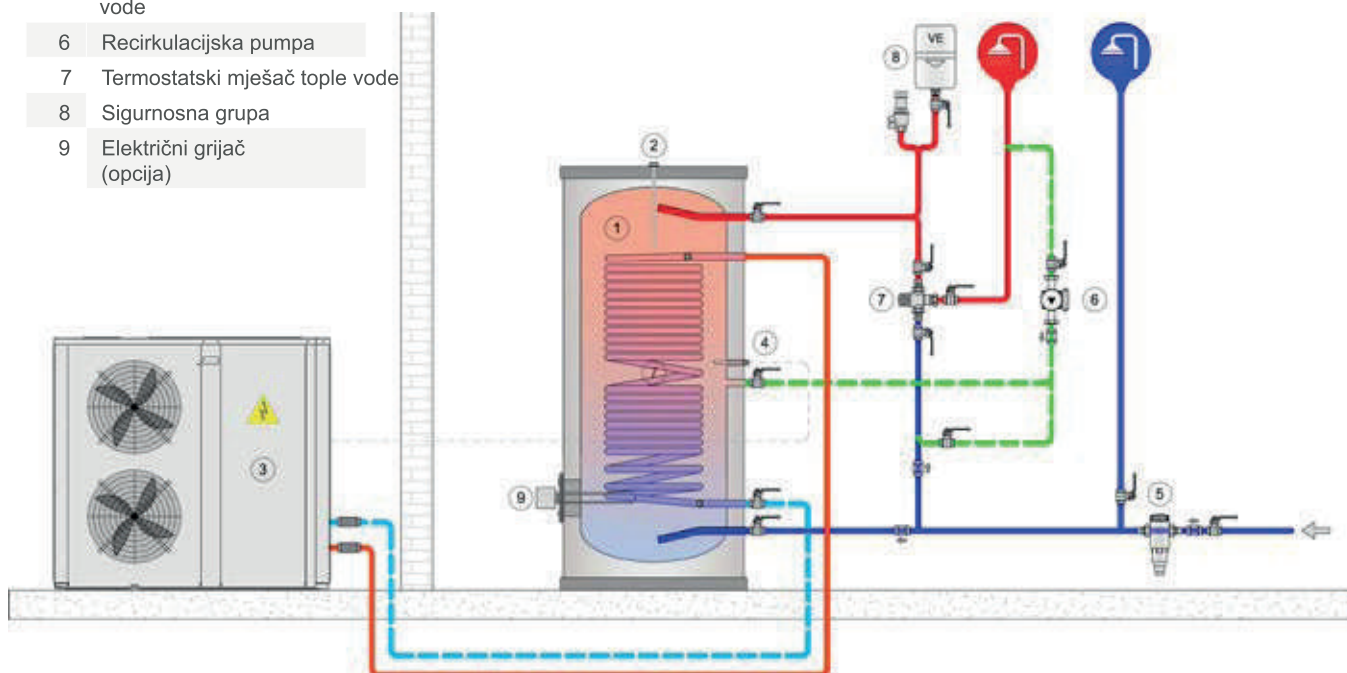

Bojleri za toplinske pumpe – SMART HP

Gubitak tlaka fiksnog izmjenjivača topline

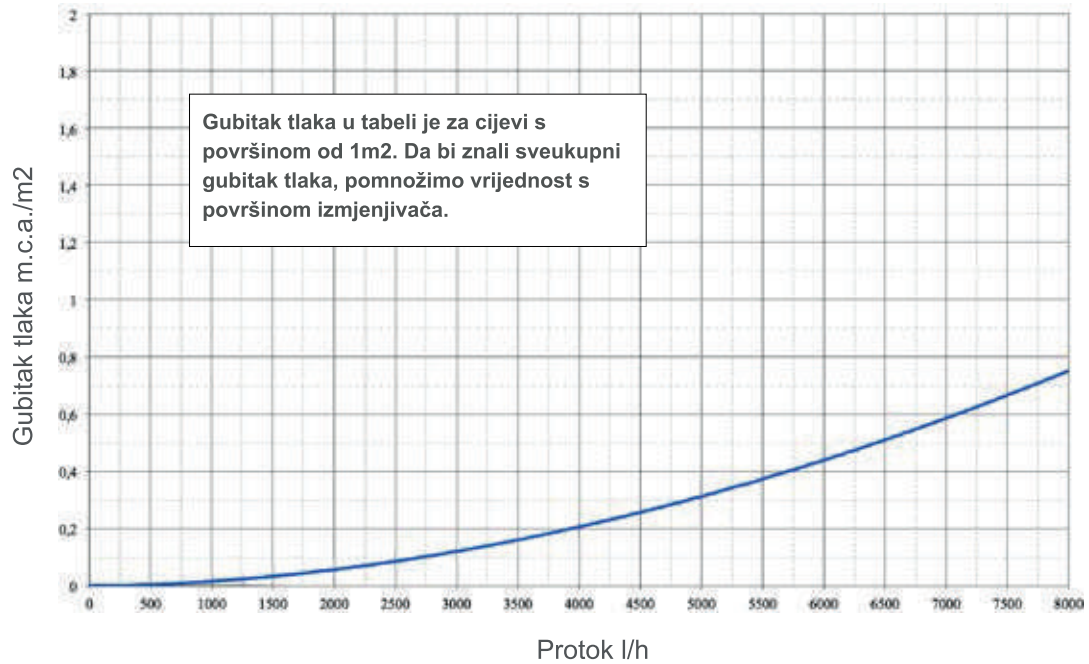

SMART 2 Bojleri

Paleta proizvoda Smart 2 sastoji se od bojlera za proizvodnju tople vode za domaćinstva s dvostrukim fiksnim izmjenjivačem topline, dostupan u nekoliko kapaciteta (od 200 do 3000 litara). Opremljeni su različitim vrstama izolacije (vidi tablicu dolje), vanjskog PVC premaza, magnezij anode za zaštitu od galvanskih struja, ispitne priрубnice za lak pristup tijekom faze kontrole i održavanja.

Materijal: S 235 JR ugljični čelik

Treatment za unutarnju zaštitu: Bojler s kapacitetom do 1000 l su emajlirani proizvodi u skladu s DIN4573.3 , oni s kapacitetom od 1500 do 3000 l su tretirani s Bluetech tehnikom.

Izolacija

Kapacitet (l)	Tip
od 200 do 1000	Kruta poliuretanska pjena visoke gustoće
od 1500	Poliester vlakna

Radna ograničenja

Kapacitet (l)	Skladištenje		Primarni krug	
	temp. max.	tlak max.	temp. max.	tlak max.
up to 1000	95°C	10 bar	110°C	12 bar
from 1500 to 3000	80°C	6 bar	110°C	12 bar



Podesive noge po visini za veličine do 500 l, sigurnosni ventil i termometar za veličine do 1000 l, magnezijum zaštitna anoda za sve veličine.



TESTED

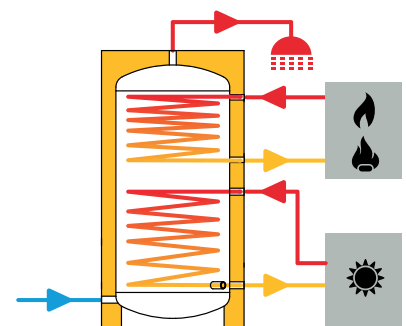

Kapacitet l	Artikal	Šifra Vokel	Energetski razred	Vertikalno pakiranje	
				Dimenzije cm	Težina kg
200	819060114X	1457008	B	75x75x120	98
300	819060115X	1457009	B	75x75x168	133
500	819060117X	1457010	C	75x75x204	215
750	819060118X	1457011	C	90x90x207	296
1000	819060119X	1457012	C	110x110x198	360
1500	819080003X		C	123x123x237,5	281
2000	819080004X		C	132x132x269,5	366
3000	819080006X			147x147x299	454

SMART 2 Bojleri

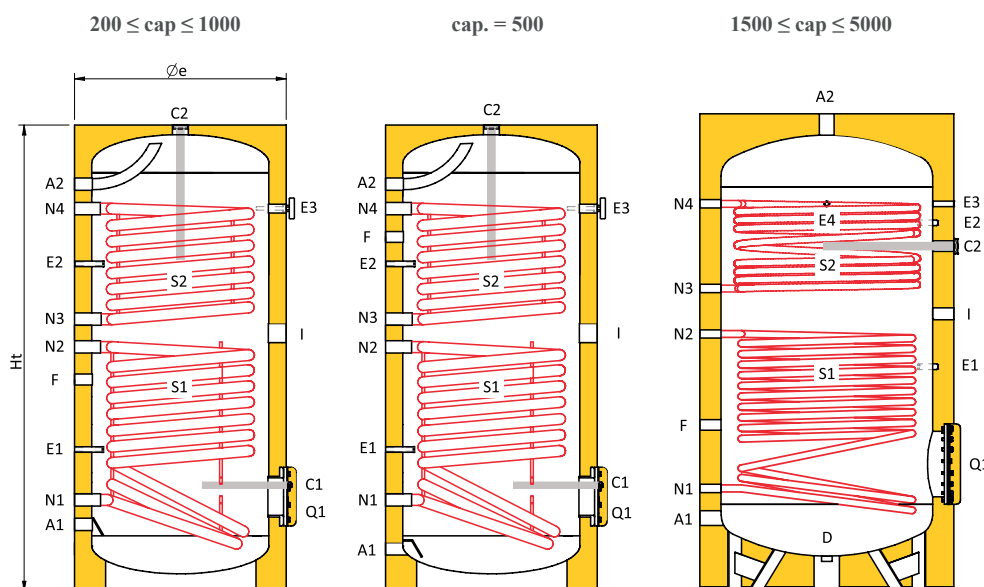

Opis

- A1 Ulaz tople vode
- A2 Izlaz tople vode
- C1 Anoda
- C2 Anoda
- D Pražnjenje
- E1 Kapilarna cijev za osjetnike
- E2 Kapilarna cijev za osjetnike
- E3 Kapilarna cijev za osjetnike
- E4 Kapilarna cijev za osjetnike
- F Recirkulacija
- I Električni grijač
- N1 Donji solarni izlaz izmjenjivača
- N2 Donji solarni ulaz izmjenjivača
- N3 Gornji kotlovski izlaz izmjenjivača
- N4 Gornji kotlovski ulaz izmjenjivača
- Q1 Inspeksijska prirubnica
- S1 Donji izmjenjivač
- S2 Gornji izmjenjivač

Spojnica

Kap. l	A1 inch	A2 inch	C1 inch	C2 inch	D inch	E1 inch	E2 inch	E3 inch	E4 inch	F inch	I inch	N1 inch	N2 inch	N3 inch	N4 inch	Q1 (Øext/Øint) mm
200	1'	1'	M8	1 1/4	-	3/8"x90	3/8"x90	1/2"	-	3/4"	1 1/2	1'	1'	1'	1'	Ø180/120
300	1'	1'	M8	1 1/4	-	3/8"x90	3/8"x90	1/2"	-	3/4"	1 1/2	1'	1'	1'	1'	Ø180/Ø120
500	1'	1'	M8	1 1/4	-	3/8"x125	3/8"x125	1/2"	-	3/4"	1 1/2	1'	1'	1'	1'	Ø180/Ø120
750	1 1/2	1 1/2	M8	2"	-	3/8"x140	3/8"x140	1/2"	-	1 1/4	1 1/2	1'	1'	1'	1'	Ø280/Ø205
1000	1 1/2	1 1/2	M8	2"	-	3/8"x160	3/8"x160	1/2"	-	1 1/4	1 1/2	1'	1'	1'	1'	Ø280/Ø205
1500	2'	2'	-	1 1/4	1 1/4	1/2"	1/2"	1/2"	1/2"	1 1/4	1 1/2	1'	1'	1'	1'	Ø380/Ø300
2000	2'	2'	-	1 1/4	1 1/4	1/2"	1/2"	1/2"	1/2"	1 1/4	1 1/2	1'	1'	1'	1'	Ø380/Ø300
3000	3'	3'	-	1 1/4	1 1/4	1/2"	1/2"	1/2"	1/2"	1 1/4	1 1/2	1'	1'	1'	1'	Ø380/Ø300

Dimenzije

Kap. l	Øe mm	Ht mm	R* mm	A1 mm	A2 mm	D mm	E1 mm	E2 mm	E3 mm	F mm	I mm	N1 mm	N2 mm	N3 mm	N4 mm	Q1 mm
200	670	1130	1290	130	975	-	345	780	825	450	630	210	580	685	895	290
300	670	1615	1750	130	1355	-	435	1030	1295	650	805	280	750	860	1200	290
500	750	1950	2090	180	1650	-	530	1200	1570	1320	1030	320	970	1090	1439	329
750	855	2050	2225	215	1715	-	575	1365	1725	925	1110	375	1045	1175	1555	445
1000	1055	1960	2230	247	1567	-	587	1247	1577	877	1047	447	997	1097	1437	477
1500	1250	2280	2605	345	-	165	1060	1740	1830	785	1310	485	1215	1430	1830	600
2000	1350	2600	2930	345	-	155	1165	2065	2150	815	1495	480	1315	1690	2150	605
3000	1450	2870	3220	400	-	180	1375	2225	2410	875	1625	550	1540	1680	2410	665

R*: povratna kvota Q1**: Visina od centra inspeksijske prirubnice do poda

SMART 2 Bojleri

Kapacitet	Ti	Proizvodnja tople vode TACS = 10°C						Visoka izmjena Površina m ²	Niska izmjena Površina m ²	Nominal protok mk/h
		TuACS = 45°C		TuACS = 60°C		Ta = 50°C TuACS = 45°C	Ta = 60°C TuACS = 45°C			
		l/h (a)	kW (b)	l/h (c)	kW (d)	l/10 min. (e)	l/10 min. (f)			
200	70	417	17	206	12	282	324	0,7	1	3
	80	540	22	292	17	302	345			
	90	614	25	361	21	315	357			
300	70	638	26	309	18	425	489	1,1	1,4	3
	80	860	35	481	28	462	526			
	90	1007	41	584	34	486	550			
400	70	638	26	309	18	531	616	1,1	1,8	3
	80	860	35	481	28	568	653			
	90	1007	41	584	34	593	678			
500	70	638	26	309	18	638	744	1,1	2	3
	80	860	35	481	28	675	781			
	90	1007	41	584	34	699	806			
750	70	688	28	344	20	912	1072	1,2	2,4	3
	80	933	38	516	30	953	1112			
	90	1081	44	636	37	978	1137			
1000	70	884	36	430	25	1211	1423	1,5	2,7	3
	80	1179	48	653	38	1260	1473			
	90	1376	56	808	47	1293	1505			
1500	70	1326	54	653	38	1816	2135	2,3	3,7	6,0
	80	1793	73	980	57	1894	2213			
	90	2113	86	1238	72	1947	2267			
2000	70	1744	71	860	50	2418	2843	3	4,3	8,0
	80	2334	95	1290	75	2516	2942			
	90	2727	111	1599	93	2582	3007			
3000	70	2211	90	1083	63	3559	4198	3,8	5,2	8,0
	80	2948	120	1634	95	3682	4321			
	90	3440	140	2029	118	3764	4403			

- a kontinuirani protok tople vode s TuACS = 45°C
- b snaga izmjenjivača s TuACS = 45°C
- c kontinuirani protok tople vode s TuACS = 60°C
- d snaga izmjenjivača s TuACS = 60°C
- e količina tople vode na 45°C u prvih 10 min s temperaturom skladištenja od 50°C
- f količina tople vode na 45°C u prvih 10 min s temperaturom skladištenja od 60°C
- kapacitet izmjenjivača: 7,10 lt/m²

SMART 2 Bojleri

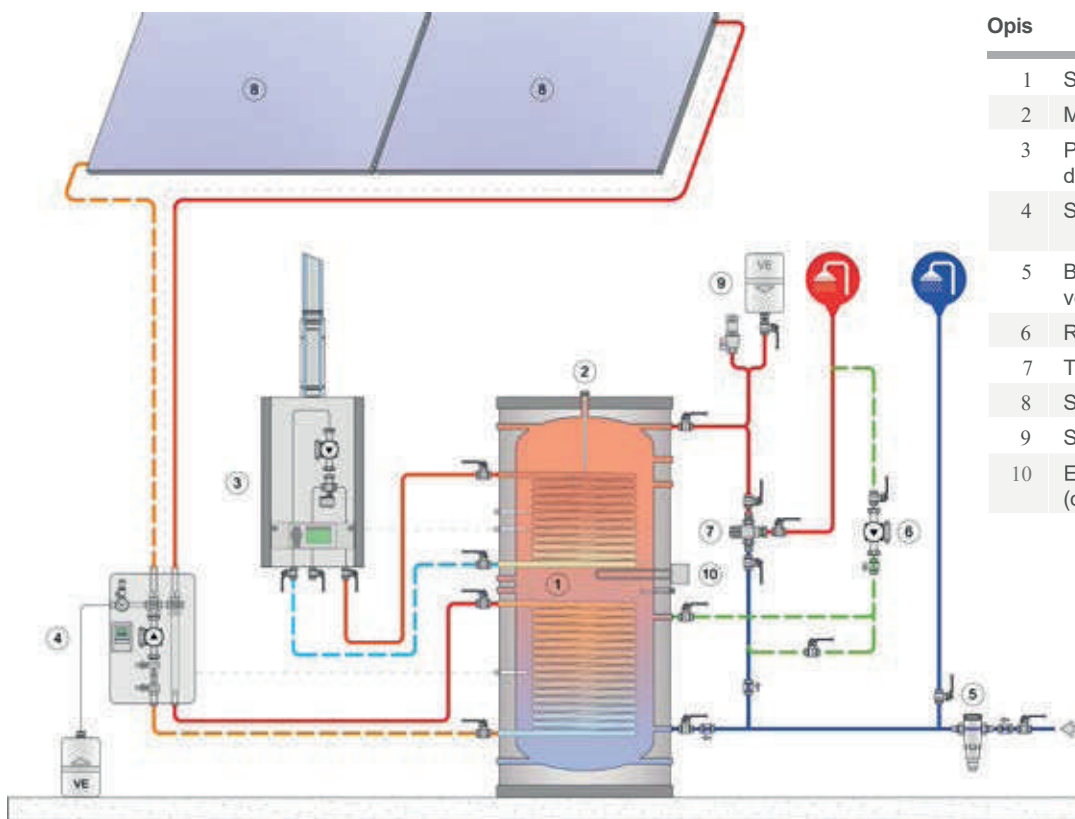

Opis

- | Opis | |
|------|-------------------------------------|
| 1 | Spremnik tople vode |
| 2 | Magnezijska anoda |
| 3 | Plinski grijač vode / dodatni izvor |
| 4 | Solarna grupa |
| 5 | Bakterijostatski filter hladne vode |
| 6 | Recirkulacijska pumpa |
| 7 | Termostatska mješalica tople vode |
| 8 | Solarni panel |
| 9 | Sigurnosna grupa |
| 10 | Električni grijač (opcija) |

Gubitak tlaka fiksnog izmjenjivača topline

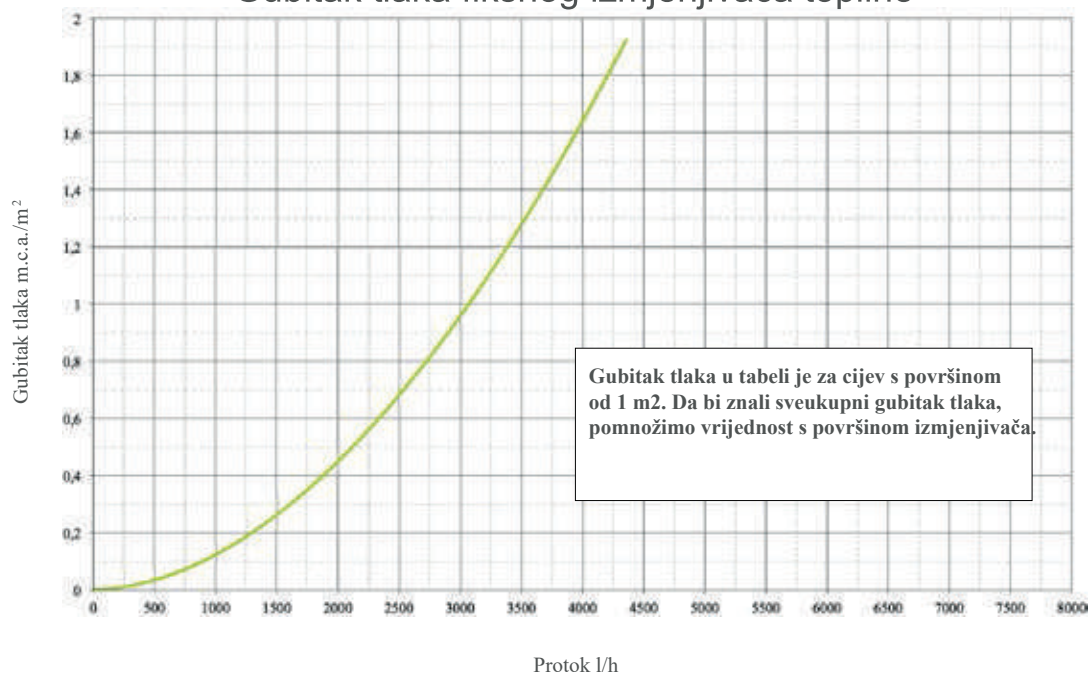

Katalog proizvoda





NISKOŠUMNE CIJEVI
ZA KUĆNU KANALIZACIJU SA GUMENOM BRTVOM

VOKEL ŠIFRA	OPIS	DIMENZIJA (Ø) cm	PAKIRANJE (kom)	ARTIKAL
0175001	NISKOŠUMNA CIJEV SILENT	32/25	100	27143
0175002	NISKOŠUMNA CIJEV SILENT	32/50	60	27144
0175003	NISKOŠUMNA CIJEV SILENT	32/100	40	27146
0175004	NISKOŠUMNA CIJEV SILENT	32/200	104	27148
0175005	NISKOŠUMNA CIJEV SILENT	40/25	60	27150
0175006	NISKOŠUMNA CIJEV SILENT	40/50	40	27151
0175007	NISKOŠUMNA CIJEV SILENT	40/100	25	27153
0175008	NISKOŠUMNA CIJEV SILENT	40/200	88	27155
0175009	NISKOŠUMNA CIJEV SILENT	50/25	90	13312
0175010	NISKOŠUMNA CIJEV SILENT	50/50	90	13313
0175011	NISKOŠUMNA CIJEV SILENT	50/100	120	13315
0175012	NISKOŠUMNA CIJEV SILENT	50/200	120	13317
0175013	NISKOŠUMNA CIJEV SILENT	50/300	80	13318
0175014	NISKOŠUMNA CIJEV SILENT	50/400	80	13319
0175015	NISKOŠUMNA CIJEV SILENT	75/25	60	13320
0175016	NISKOŠUMNA CIJEV SILENT	75/50	60	13321
0175017	NISKOŠUMNA CIJEV SILENT	75/100	56	13323
0175018	NISKOŠUMNA CIJEV SILENT	75/200	56	13325
0175019	NISKOŠUMNA CIJEV SILENT	75/300	56	13326
0175020	NISKOŠUMNA CIJEV SILENT	75/400	56	13327
0175021	NISKOŠUMNA CIJEV SILENT	110/25	40	13328
0175022	NISKOŠUMNA CIJEV SILENT	110/50	40	13329
0175023	NISKOŠUMNA CIJEV SILENT	110/100	30	13331
0175024	NISKOŠUMNA CIJEV SILENT	110/200	30	13333
0175025	NISKOŠUMNA CIJEV SILENT	110/300	30	13334
0175026	NISKOŠUMNA CIJEV SILENT	110/400	30	13335
0175027	NISKOŠUMNA CIJEV SILENT	125/25	28	13336
0175028	NISKOŠUMNA CIJEV SILENT	125/50	28	13337
0175029	NISKOŠUMNA CIJEV SILENT	125/100	24	13339
0175030	NISKOŠUMNA CIJEV SILENT	125/200	24	13341
0175031	NISKOŠUMNA CIJEV SILENT	125/300	24	13342
0175032	NISKOŠUMNA CIJEV SILENT	125/400	24	13343
0175033	NISKOŠUMNA CIJEV SILENT	160/25	18	13344
0175034	NISKOŠUMNA CIJEV SILENT	160/50	18	13345
0175035	NISKOŠUMNA CIJEV SILENT	160/100	18	13347
0175036	NISKOŠUMNA CIJEV SILENT	160/200	18	13349
0175037	NISKOŠUMNA CIJEV SILENT	160/300	18	13350
0175038	NISKOŠUMNA CIJEV SILENT	160/400	18	13351



PP KOLJENO

VOKEL ŠIFRA	OPIS	DIMENZIJA (Ø)	PAKIRANJE (pak/kom)	ARTIKAL
0175043	NISKOŠUMNO KOLJENO	50/15°C	20	13424
0175047	NISKOŠUMNO KOLJENO	75/15°C	20	13428
0175051	NISKOŠUMNO KOLJENO	110/15°C	20	13433
0175055	NISKOŠUMNO KOLJENO	125/15°C	20	13438
0175059	NISKOŠUMNO KOLJENO	160/15°C	6	13443
0175044	NISKOŠUMNO KOLJENO	50/30°C	20	13425
0175048	NISKOŠUMNO KOLJENO	75/30°C	20	13429
0175052	NISKOŠUMNO KOLJENO	110/30°C	20	13434
0175056	NISKOŠUMNO KOLJENO	125/30°C	20	13439
0175060	NISKOŠUMNO KOLJENO	160/30°C	6	13444
0175039	NISKOŠUMNO KOLJENO	32/45°C	70	25229
0175041	NISKOŠUMNO KOLJENO	40/45°C	20	25231
0175045	NISKOŠUMNO KOLJENO	50/45°C	20	13426
0175049	NISKOŠUMNO KOLJENO	75/45°C	20	13430
0175053	NISKOŠUMNO KOLJENO	110/45°C	20	13435
0175057	NISKOŠUMNO KOLJENO	125/45°C	20	13440
0175061	NISKOŠUMNO KOLJENO	160/45°C	6	13445
0175040	NISKOŠUMNO KOLJENO	32/90°C	70	25230
0175045	NISKOŠUMNO KOLJENO	40/90°C	20	25232
0175046	NISKOŠUMNO KOLJENO	50/90°C	20	13427
0175050	NISKOŠUMNO KOLJENO	75/90°C	20	13432
0175054	NISKOŠUMNO KOLJENO	110/90°C	20	13437
0175058	NISKOŠUMNO KOLJENO	125/90°C	20	13442
0175062	NISKOŠUMNO KOLJENO	160/90°C	4	13447



PP RAČVA 40°

VOKEL ŠIFRA	OPIS	DIMENZIJA (Ø)	PAKIRANJE (pak/kom)	ARTIKAL
0175063	NISKOŠUMNA RAČVA 45°	32/32/45°	20	25233
0175064	NISKOŠUMNA RAČVA 45°	40/40/45°	20	25235
0175066	NISKOŠUMNA RAČVA 45°	50/40/45°	20	27157
0175065	NISKOŠUMNA RAČVA 45°	50/50/45°	20	13448
0175068	NISKOŠUMNA RAČVA 45°	75/50/45°	20	13452
0175067	NISKOŠUMNA RAČVA 45°	75/75/45°	20	13450
0175070	NISKOŠUMNA RAČVA 45°	110/50/45°	20	13456
0175071	NISKOŠUMNA RAČVA 45°	110/75/45°	16	13458
0175069	NISKOŠUMNA RAČVA 45°	110/110/45°	16	13454
0175073	NISKOŠUMNA RAČVA 45°	125/110/45°	6	13462
0175072	NISKOŠUMNA RAČVA 45°	125/125/45°	5	13460
0175075	NISKOŠUMNA RAČVA 45°	160/110/45°	6	13466
0175076	NISKOŠUMNA RAČVA 45°	160/125/45°	6	13468
0175074	NISKOŠUMNA RAČVA 45°	160/160/45°	4	13464



PP RAČVA 90°

VOKEL ŠIFRA	OPIS	DIMENZIJA (Ø)	PAKIRANJE (pak/kom)	ARTIKAL
0175077	NISKOŠUMNA RAČVA 90°	32/32/90°	20	25234
0175078	NISKOŠUMNA RAČVA 90°	40/40/90°	20	25236
0175080	NISKOŠUMNA RAČVA 90°	50/40/90°	20	27159
0175079	NISKOŠUMNA RAČVA 90°	50/50/90°	20	13449
0175082	NISKOŠUMNA RAČVA 90°	75/50/90°	20	13453
0175081	NISKOŠUMNA RAČVA 90°	75/75/90°	20	13451
0175084	NISKOŠUMNA RAČVA 90°	110/50/90°	24	13457
0175085	NISKOŠUMNA RAČVA 90°	110/75/90°	20	13459
0175083	NISKOŠUMNA RAČVA 90°	110/110/90°	14	13455
0175087	NISKOŠUMNA RAČVA 90°	125/110/90°	8	13463
0175086	NISKOŠUMNA RAČVA 90°	125/125/90°	6	13461
0175089	NISKOŠUMNA RAČVA 90°	160/110/90°	10	13467
0175090	NISKOŠUMNA RAČVA 90°	160/125/90°	6	13469
0175088	NISKOŠUMNA RAČVA 90°	160/160/90°	6	13465



PP DVOSTRANA RAČVA

VOKEL ŠIFRA	OPIS	DIMENZIJA (Ø)	PAKIRANJE (pak/kom)	ARTIKAL
0175091	NISKOŠUMNA DVOSTRUKA RAČVA	50/50/50/45°	20	13470
0175093	NISKOŠUMNA DVOSTRUKA RAČVA	110/110/110/45°	6	13474
0175092	NISKOŠUMNA DVOSTRUKA RAČVA	50/50/50/90°	20	13471
0175094	NISKOŠUMNA DVOSTRUKA RAČVA	110/110/110/90°	6	13475



PP KLIZNA SPOJKA

VOKEL ŠIFRA	OPIS	DIMENZIJA (Ø)	PAKIRANJE (pak/kom)	ARTIKAL
0175095	NISKOŠUMNA KLIZNA SPOJKA	40	20	25237
0175096	NISKOŠUMNA KLIZNA SPOJKA	50	20	13476
0175097	NISKOŠUMNA KLIZNA SPOJKA	75	20	13477
0175098	NISKOŠUMNA KLIZNA SPOJKA	110	20	13478
0175099	NISKOŠUMNA KLIZNA SPOJKA	125	8	13479
0175100	NISKOŠUMNA KLIZNA SPOJKA	160	12	13480



PP REDUKCIJA

VOKEL ŠIFRA	OPIS	DIMENZIJA (Ø)	PAKIRANJE (pak/kom)	ARTIKAL
0175101	NISKOŠUMNA REDUKCIJA	40/32	20	25240
0175102	NISKOŠUMNA REDUKCIJA	50/32	20	25241
0175103	NISKOŠUMNA REDUKCIJA	50/40	20	25242
0175104	NISKOŠUMNA REDUKCIJA	75/40	20	25243
0175105	NISKOŠUMNA REDUKCIJA	75/50	20	13481
0175106	NISKOŠUMNA REDUKCIJA	110/50	20	13482
0175107	NISKOŠUMNA REDUKCIJA	110/75	20	13483
0175108	NISKOŠUMNA REDUKCIJA	125/110	12	13484
0175109	NISKOŠUMNA REDUKCIJA	160/110	20	13485
0175110	NISKOŠUMNA REDUKCIJA	160/125	14	13486



PP ČISTAČ

VOKEL ŠIFRA	OPIS	DIMENZIJA (Ø)	PAKIRANJE (pak/kom)	ARTIKAL
0175111	NISKOŠUMNI ČISTAČ	50	25	13487
0175112	NISKOŠUMNI ČISTAČ	75	20	13488
0175113	NISKOŠUMNI ČISTAČ	110	20	13489
0175114	NISKOŠUMNI ČISTAČ	125	8	13490
0175115	NISKOŠUMNI ČISTAČ	160	6	13491





PP ČEP







VOKEL ŠIFRA	OPIS	DIMENZIJA (Ø)	PAKIRANJE (pak/kom)	ARTIKAL
0175116	NISKOŠUMNI ČEP	32	100	25238
0175117	NISKOŠUMNI ČEP	40	100	25239
0175118	NISKOŠUMNI ČEP	50	100	13492
0178119	NISKOŠUMNI ČEP	75	100	13493
0175120	NISKOŠUMNI ČEP	110	80	13494
0175121	NISKOŠUMNI ČEP	125	60	13495
0175122	NISKOŠUMNI ČEP	160	30	13496

UKC/PVC
CIJEVI I SPOJEVI



UKC/PVC CIJEVI I SPOJEVI			PAKIRANJE
	0176010 0176022 0176011 0176019	UKC CIJEV TROSLOJNA Ø 110/25 cm PEŠTAN SDR41 SN4	600
		UKC CIJEV TROSLOJNA Ø 110/50 cm PEŠTAN SDR41 SN4	200
		UKC CIJEV TROSLOJNA Ø 110/100 cm PEŠTAN SDR41 SN4	76
		UKC CIJEV TROSLOJNA Ø 110/200 cm PEŠTAN SDR41 SN4	76
		UKC CIJEV TROSLOJNA Ø 110/300 cm PEŠTAN SDR41 SN4	76
		UKC CIJEV TROSLOJNA Ø 110/400 cm PEŠTAN SDR41 SN4	76
	0176017 0176018 0176020 0176013	UKC CIJEV TROSLOJNA Ø 125/25 cm PEŠTAN SDR41 SN4	540
		UKC CIJEV TROSLOJNA Ø 125/50 cm PEŠTAN SDR41 SN4	160
		UKC CIJEV TROSLOJNA Ø 125/100 cm PEŠTAN SDR41 SN4	60
		UKC CIJEV TROSLOJNA Ø 125/200 cm PEŠTAN SDR41 SN4	60
		UKC CIJEV TROSLOJNA Ø 125/300 cm PEŠTAN SDR41 SN4	60
		UKC CIJEV TROSLOJNA Ø 125/400 cm PEŠTAN SDR41 SN4	60
	0176029 0176028 0176030 0176031	UKC CIJEV TROSLOJNA Ø 160/25 cm PEŠTAN SDR41 SN4	200
		UKC CIJEV TROSLOJNA Ø 160/50 cm PEŠTAN SDR41 SN4	96
		UKC CIJEV TROSLOJNA Ø 160/100 cm PEŠTAN SDR41 SN4	52
		UKC CIJEV TROSLOJNA Ø 160/200 cm PEŠTAN SDR41 SN4	53
		UKC CIJEV TROSLOJNA Ø 160/300 cm PEŠTAN SDR41 SN4	53
		UKC CIJEV TROSLOJNA Ø 160/400 cm PEŠTAN SDR41 SN4	53
	0176025 0176026 0176027 0176032	UKC CIJEV TROSLOJNA Ø 200/25 cm PEŠTAN SDR41 SN4	60
		UKC CIJEV TROSLOJNA Ø 200/50 cm PEŠTAN SDR41 SN4	30
		UKC CIJEV TROSLOJNA Ø 200/100 cm PEŠTAN SDR41 SN4	30
		UKC CIJEV TROSLOJNA Ø 200/200 cm PEŠTAN SDR41 SN4	30
		UKC CIJEV TROSLOJNA Ø 200/300 cm PEŠTAN SDR41 SN4	30
		UKC CIJEV TROSLOJNA Ø 200/400 cm PEŠTAN SDR41 SN4	30
	0176038 0176034 0176039 0176040	UKC CIJEV TROSLOJNA Ø 250/25 cm PEŠTAN SDR41 SN4	60
		UKC CIJEV TROSLOJNA Ø 250/50 cm PEŠTAN SDR41 SN4	40
		UKC CIJEV TROSLOJNA Ø 250/100 cm PEŠTAN SDR41 SN4	20
UKC CIJEV TROSLOJNA Ø 250/200 cm PEŠTAN SDR41 SN4		20	
UKC CIJEV TROSLOJNA Ø 250/300 cm PEŠTAN SDR41 SN4		20	
UKC CIJEV TROSLOJNA Ø 250/400 cm PEŠTAN SDR41 SN4		20	
0176036 0176035 0176037 0176033	UKC CIJEV TROSLOJNA Ø 315/25 cm PEŠTAN SDR41 SN4	*	
	UKC CIJEV TROSLOJNA Ø 315/50 cm PEŠTAN SDR41 SN4	12	
	UKC CIJEV TROSLOJNA Ø 315/100 cm PEŠTAN SDR41 SN4	12	
	UKC CIJEV TROSLOJNA Ø 315/200 cm PEŠTAN SDR41 SN4	12	
	UKC CIJEV TROSLOJNA Ø 315/300 cm PEŠTAN SDR41 SN4	12	
	UKC CIJEV TROSLOJNA Ø 315/400 cm PEŠTAN SDR41 SN4	12	
	UKC CIJEV TROSLOJNA Ø 315/600 cm PEŠTAN SDR41 SN4	12	

UKC/PVC CIJEVI I SPOJEVI			PAKIRANJE
	0173007	PVC RAČVA Ø 110/110/45° PEŠTAN	20
	0173008	PVC RAČVA Ø 125/110/45° PEŠTAN	16
	0173009	PVC RAČVA Ø 125/125/45° PEŠTAN	12
	0173010	PVC RAČVA Ø 160/110/45° PEŠTAN	9
	0173063	PVC RAČVA Ø 160/125/45° PEŠTAN	8
	0173011	PVC RAČVA Ø 160/160/45° PEŠTAN	6
	0173014	PVC RAČVA Ø 200/110/45° PEŠTAN	15
	0173012	PVC RAČVA Ø 200/125/45° PEŠTAN	15
	0173013	PVC RAČVA Ø 200/160/45° PEŠTAN	13
	0173015	PVC RAČVA Ø 200/200/45° PEŠTAN	10
	0173056	PVC RAČVA Ø 250/110/45° PEŠTAN	6
	0173064	PVC RAČVA Ø 250/125/45° PEŠTAN	6
	0173016	PVC RAČVA Ø 250/160/45° PEŠTAN	6
		PVC RAČVA Ø 250/200/45° PEŠTAN	5
	0173057	PVC RAČVA Ø 250/250/45° PEŠTAN	3
	0173058	PVC RAČVA Ø 315/110/45° PEŠTAN	4
	0173059	PVC RAČVA Ø 315/125/45° PEŠTAN	4
	0173060	PVC RAČVA Ø 315/160/45° PEŠTAN	4
		PVC RAČVA Ø 315/200/45° PEŠTAN	4
	0173061	PVC RAČVA Ø 315/250/45° PEŠTAN	2
	PVC RAČVA Ø 315/315/45° PEŠTAN	2	
	0173046	PVC RAČVA Ø 110/110/90° PEŠTAN	25
	0173065	PVC RAČVA Ø 125/110/90° PEŠTAN	19
	0173066	PVC RAČVA Ø 125/125/90° PEŠTAN	16
	0173067	PVC RAČVA Ø 160/110/90° PEŠTAN	12
		PVC RAČVA Ø 160/125/90° PEŠTAN	10
	0173017	PVC RAČVA Ø 160/160/90° PEŠTAN	8
	0173068	PVC RAČVA Ø 200/110/90° PEŠTAN	20
		PVC RAČVA Ø 200/125/90° PEŠTAN	18
		PVC RAČVA Ø 200/160/90° PEŠTAN	16
	0173069	PVC RAČVA Ø 200/200/90° PEŠTAN	13
		PVC RAČVA Ø 250/110/90° PEŠTAN	11
		PVC RAČVA Ø 250/125/90° PEŠTAN	10
		PVC RAČVA Ø 250/160/90° PEŠTAN	9
		PVC RAČVA Ø 250/200/90° PEŠTAN	8
	0173062	PVC RAČVA Ø 250/250/90° PEŠTAN	6
		PVC RAČVA Ø 315/110/90° PEŠTAN	5
		PVC RAČVA Ø 315/125/90° PEŠTAN	5
		PVC RAČVA Ø 315/160/90° PEŠTAN	5
		PVC RAČVA Ø 315/200/90° PEŠTAN	5
		PVC RAČVA Ø 315/250/90° PEŠTAN	4
	PVC RAČVA Ø 315/315/90° PEŠTAN	2	

UKC CIJEVI I SPOJEVI			PAKIRANJE
	0173051	PVC KOLJENO Ø 110/15° PEŠTAN	60
	0173052	PVC KOLJENO Ø 125/15° PEŠTAN	40
	0173053	PVC KOLJENO Ø 160/15° PEŠTAN	20
	0173031	PVC KOLJENO Ø 200/15° PEŠTAN	10
		PVC KOLJENO Ø 250/15° PEŠTAN	*
		PVC KOLJENO Ø 315/15° PEŠTAN	*
	0173054	PVC KOLJENO Ø 110/30° PEŠTAN	50
	0173055	PVC KOLJENO Ø 125/30° PEŠTAN	35
	0173032	PVC KOLJENO Ø 160/30° PEŠTAN	17
	0173033	PVC KOLJENO Ø 200/30° PEŠTAN	7/24
		PVC KOLJENO Ø 250/30° PEŠTAN	*
		PVC KOLJENO Ø 315/30° PEŠTAN	*
	0173001	PVC KOLJENO Ø 110/45° PEŠTAN	50
	0173030	PVC KOLJENO Ø 125/45° PEŠTAN	30
	0173002	PVC KOLJENO Ø 160/45° PEŠTAN	15
	0173003	PVC KOLJENO Ø 200/45° PEŠTAN	8
	0173005	PVC KOLJENO Ø 250/45° PEŠTAN	7
	0173034	PVC KOLJENO Ø 315/45° PEŠTAN	6
		PVC KOLJENO Ø 110/90° PEŠTAN	40
		PVC KOLJENO Ø 125/90° PEŠTAN	25
		PVC KOLJENO Ø 160/90° PEŠTAN	12
	0173004	PVC KOLJENO Ø 200/90° PEŠTAN	6
	0173006	PVC KOLJENO Ø 250/90° PEŠTAN	8
	0173035	PVC KOLJENO Ø 315/90° PEŠTAN	4
	0173049	KLIZNA SPOJKA DN 110 PEŠTAN	60
	0173073	KLIZNA SPOJKA DN 125 PEŠTAN	45
	0173050	KLIZNA SPOJKA DN 160 PEŠTAN	18
	0173024	KLIZNA SPOJKA DN 200 PEŠTAN	33
	0173025	KLIZNA SPOJKA DN 250 PEŠTAN	12
	0173048	KLIZNA SPOJKA DN 315 PEŠTAN	7
	0173029	PVC REDUKCIJA DN 125/110 PEŠTAN	48
	0173018	PVC REDUKCIJA DN 160/110 PEŠTAN	36
	0173019	PVC REDUKCIJA DN 160/125 PEŠTAN	36
	0173070	PVC REDUKCIJA DN 200/110 PEŠTAN	44
	0173021	PVC REDUKCIJA DN 200/160 PEŠTAN	42
	0173022	PVC REDUKCIJA DN 250/200 PEŠTAN	26
	0173071	PVC REDUKCIJA DN 315/200 PEŠTAN	
	0173072	PVC REDUKCIJA DN 315/250 PEŠTAN	16

UKC CIJEVI I SPOJEVI			PAKIRANJE
	0173020	PVC REDUKCIJA RAVNA DN 110/200 PEŠTAN	*
		PVC REDUKCIJA RAVNA DN 110/250 PEŠTAN	*
		PVC REDUKCIJA RAVNA DN 110/315 PEŠTAN	*
		PVC REDUKCIJA RAVNA DN 125/200 PEŠTAN	20
		PVC REDUKCIJA RAVNA DN 125/250 PEŠTAN	*
		PVC REDUKCIJA RAVNA DN 125/315 PEŠTAN	*
		PVC REDUKCIJA RAVNA DN 160/250 PEŠTAN	*
		PVC REDUKCIJA RAVNA DN 160/315 PEŠTAN	*
		PVC REDUKCIJA RAVNA DN 200/315 PEŠTAN	*
	0173037	PVC ČISTAČ DN 110/110 PEŠTAN	30
	0173038	PVC ČISTAČ DN 125/110 PEŠTAN	20
	0173039	PVC ČISTAČ DN 160/160 PEŠTAN	9
	0173041	PVC ČISTAČ DN 200/160 PEŠTAN	17
		PVC ČISTAČ DN 250/160 PEŠTAN	9
		PVC ČISTAČ DN 315/160 PEŠTAN	5
	0173026	ČEP PVC Ø 110 PEŠTAN	*
		ČEP PVC Ø 125 PEŠTAN	*
	0173027	ČEP PVC Ø 160 PEŠTAN	45
	0173028	ČEP PVC Ø 200 PEŠTAN	25
	0173040	ČEP PVC Ø 250 PEŠTAN	51
	0173042	VENTIL NEPOVRATNI Ø 110 PEŠTAN	1
	0173043	VENTIL NEPOVRATNI Ø 125 PEŠTAN	1
	0173044	VENTIL NEPOVRATNI Ø 160 PEŠTAN	1
	0173045	VENTIL NEPOVRATNI Ø 200 PEŠTAN	1
		VENTIL NEPOVRATNI Ø 250 PEŠTAN	1
		VENTIL NEPOVRATNI Ø 310 PEŠTAN	1

USISAVAČ ZA HLADNI PEPEO S HEPA FILTEROM



tank: 15 l
 snaga: 800 W
 duljina kabela: 3 m
 duljina usisnog crijeva: 2 m
 promjer usisnog crijeva: 30 mm



Vokel šifra	Opis	Snaga (W)	Art.
1463001	Usisavač za hladni pepeo	800	MWA503C-15L-800W
1463002	Hepa filter za Windy Plus usisavač	-	D401-Z103H124



POLIKA
WC ŠKOLJKA VISEĆA

Vokel šifra	Opis	Dimenzije (cm)	Paleta (kom)	Šifra artikla
1714009	POLIKA	35,4x52,6	18	PERTH WC WH



UMIVAONIK ATLAS
55x46 cm

Vokel šifra	Opis	Dimenzije (cm)	Paleta (kom)
1714003	Atlas	55x46	24

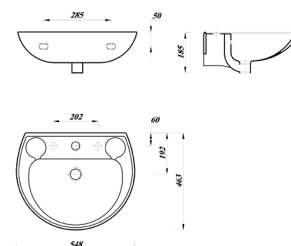

UMIVAONIK ATLAS GEO
60x45 cm

Vokel šifra	Opis	Dimenzije (cm)	Paleta (kom)
1714004	Atlas Geo	60x45	24

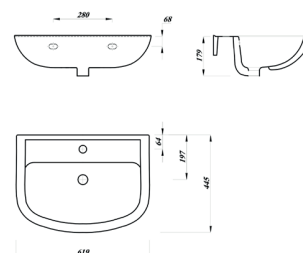

UMIVAONIK SOLLIA
UGRADNI 53x43 cm

Vokel šifra	Opis	Dimenzije (cm)	Paleta (kom)
1714005	Sollia - ugradni	53x43	16

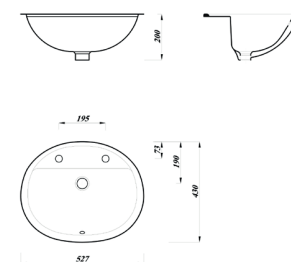



Podžbukni set Elite se sastoji od:

- mješač
- rozeta
- zidni priključak
- tuš glava
- držač tuša
- tuš ručica
- crijevo
- zidni držač

ŠIFRA VOKEL	OPIS	BOJA	ART.
1176018	PODŽBUKNI SET-MJEŠAČ ELITE DUO	KROM	00377



BATERIJA DUO - PODŽBUKNI SET

MLAZNICA TUŠA, RUČICA TUŠA, ZIDNI DRŽAČ TUŠA, ZIDNI PRIKLJUČAK, DRŽAČ TUŠ RUČICE, CRIJEVO, ROZETA I RUČICA, UZIDNA MJEŠALICA

ŠIFRA VOKEL	BOJA	ŠIFRA ARTIKLA	PAKIRANJE
0420032	KROM	00371	1

TERMOSTATSKA PODŽBUKNA BATERIJA

+ NADŽBUKNI DIO



ŠIFRA VOKEL	BOJA	ŠIFRA ARTIKLA	PAKIRANJE
1131043	KROM	00399	1

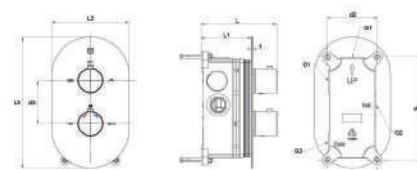

Order No.	L [mm]	L1 [mm]	L2 [mm]	L3 [mm]	d1 [mm]	d2 [mm]	d3 [mm]	f [mm]	C1 [in]	C2 [in]
0420032	1327	916	1402	45	135.70	58	62	2	12.3	2.4

ER serija za grijanje

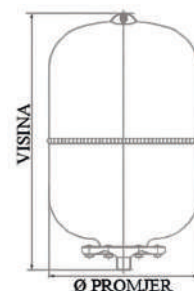

MODEL	KAPACITET [litara]	VOKEL ŠIFRA	VISINA [mm]	PROMJER [mm]	TLAK [bar]	NAVOJ [inč]
ER-24 CE	24	1466001	355	320	1,5-8	3/4"

ERCE serija za grijanje

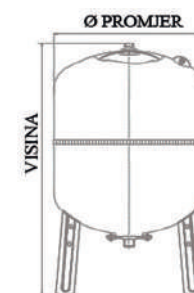

MODEL	KAPACITET [litara]	VOKEL ŠIFRA	VISINA [mm]	PROMJER [mm]	TLAK [bar]	NAVOJ [inč]
ERCE-35	35	1466002	390	400	1,5-10	3/4"
ERCE-35 S NOG.	35	1466003	390	400	1,5-10	3/4"
ERCE-50	50	1466004	500	400	1,5-10	3/4"
ERCE-50 S NOG.	50	1466005	500	400	1,5-10	3/4"
ERCE-80	80	1466006	840	400	1,5-10	1"
ERCE-100	100	1466007	795	500	1,5-10	1"
ERCE-200	200	1466022	1020	600	1,5-10	1"
ERCE-300	300	1466008	1265	650	1,5-10	1"

DP serija za sanitarnu vodu

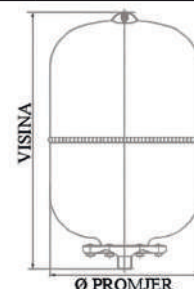

MODEL	KAPACITET [litara]	VOKEL ŠIFRA	VISINA [mm]	PROMJER [mm]	TLAK [bar]	NAVOJ [inč]
DP5 CE	5	1466009	225	205	3-10	3/4"
DP8 CE	8	1466010	300	205	3-10	3/4"
DP11	11	1466011	300	270	3-10	3/4"
DP24	24	1466012	355	320	3-10	1"
DP35	35	1466013	390	400	3-10	1"

DPV serija

za sanitarnu vodu

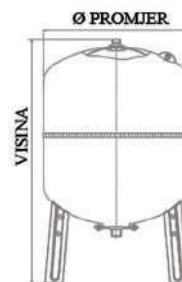

MODEL	KAPACITET [litara]	VOKEL ŠIFRA	VISINA [mm]	PROMJER [mm]	TLAK [bar]	NAVOJ [inč]
DPV50	50	1466014	585	400	3-10	1"
DPV100	100	1466015	775	500	3-10	5/4"

DS serija

za solarno

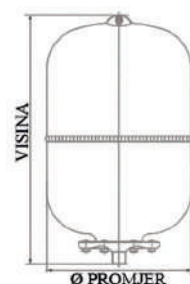

MODEL	KAPACITET [litara]	VOKEL ŠIFRA	VISINA [mm]	PROMJER [mm]	TLAK [bar]	NAVOJ [inč]
DS18-CE	18	1466016	410	270	3-8	3/4"

DSV serija

za solarno

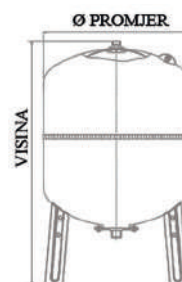

MODEL	KAPACITET [litara]	VOKEL ŠIFRA	VISINA [mm]	PROMJER [mm]	TLAK [bar]	NAVOJ [inč]
DSV80-CE	80	1466017	840	400	3-10	1"
DSV100-CE	100	1466018	795	500	3-10	1"

ERP 320 serija

za grijanje

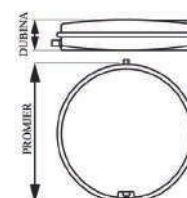

MODEL	KAPACITET [litara]	VOKEL ŠIFRA	DUBINA [mm]	PROMJER [mm]	TLAK [bar]	NAVOJ [inč]
ERP320/10	10	1466019	131	320	1-3	3/4"

ERP-RET serija

za grijanje

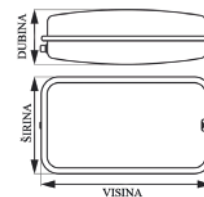

MODEL	KAPACITET [litara]	VOKEL ŠIFRA	VISINA [mm]	ŠIRINA [mm]	DUBINA [mm]	TLAK [bar]	NAVOJ [inč]
ERPRET/10	10	1466020	516	196	124	1-3	3/4"
ERPRET/12	12	1466021	516	196	152	1-3	3/4"

Aria

GLAVNE KARAKTERISTIKE:

- Čvrstoća, homogenost i dugotrajnost
- Moderan i elegantan dizajn
- Otpornost na udarce, abraziju i ogrebotine
- Jednostavnost održavanja i čišćenja
- Antibakterijski proizvod sa hipoalergenim svojstvima
- Otporan na vatru, toplinu i vlagu
- Nepodložan plijesni, truljenju i propadanju

CRNA & BIJELA

JEZGRA ISPUNE PLOČE



6

dekorativnih uzorka



Tobacco



Black



Honey



Calacatta



Grey



White



Preporučene mjere ugradnje:

Aria Compact Top
(gornja ploča)

➔ 75-80 cm od poda

Aria Compact Base
(ladica+pokrovnna ploča)

➔ 10 cm od poda

ARIA COMPACT

Zahvaljujući višeslojnoj strukturi od papira impregniranih smolom i dekorativnog površinskog sloja, compact ploče posebno su prikladne za površine koje se učestalo koriste.

Primjena ovih ploča u zadnjem desetljeću višestruko je uvećana, tako ih sada možemo pronaći u raznim dijelovima kućanstva poput kupaonskog namještaja ili kuhinjskih ploha pa sve do površina u medicinskim laboratorijima zbog svojih visokih antibakterijskih svojstava.

ZNAČAJKE:

- Čvrstoća, homogenost i dugotrajnost
- Moderan i elegantan dizajn
- Otpornost na udarce, abraziju i ogrebotine
- Jednostavnost održavanja i čišćenja
- Antibakterijski proizvod sa hipoalergenim svojstvima
- Otporan na vatru, toplinu i vlagu
- Nepodložan plijesni, truljenju i propadanju

MOGUĆNOSTI I MONTAŽA

- Visina ugradnje je proizvoljna, ovisna o prostoru, visini umivaonika, ostavljenim izvodima vode
- Mogućnost izrade namještaja prema posebnim/željenim dimenzijama
- Namještaj, gornja ploča bez rupa za bateriju i umivaonik tako da kupac sam buši rupu prema želji zbog položaja umivaonika
- Pokrovnu ploču baze potrebno je zalijepiti multifunkcionalnim lijepilom ili silikonom
- Namještaji dolaze sa podesivim nosačima ali bez ručica jer kupac može birati jednu od ponuđene 4 vrste ručica iz ponude
- Uz namještaj NE dolaze vijci za montažu
- Zid na koji se namještaj montira ukoliko nije betonski treba ojačati kako bi se namještaj mogao pravilno montirati

Kombinacija izdržljivosti i elegantnog dizajna čini ARIA COMPACT namještaj odličnim i suvremenim rješenjem za privatne i komercijalne interijere.



GLAVNE KARAKTERISTIKE:

- Čvrstoća, homogenost i dugotrajnost
- Otpornost na ogrebotine, toplinu i vlagu
- Antibakterijski sa hipoalergenim svojstvima
- Jednostavnost održavanja i čišćenja

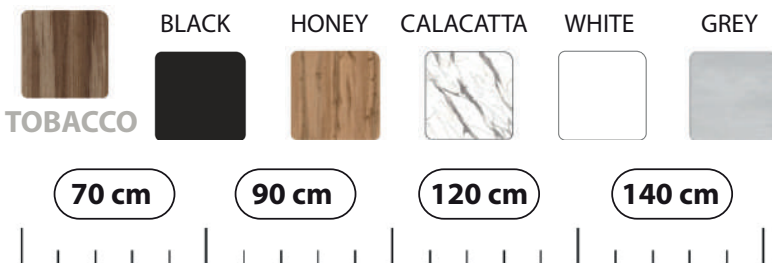

VOKEL ŠIFRA	OPIS	ART.
KOMPOZICIJA ARIA COMPACT TOBACCO 70 cm		
1716001	ARIA COMPACT TOP, PLOČA ZA UMIVAONIK, 70x52x13, S NOSAČIMA	ACT70T
1718001	ARIA COMPACT BASE, LADICA + POKROVNA PLOČA, 70x50x26	ACB70T
KOMPOZICIJA ARIA COMPACT TOBACCO 90 cm		
1716005	ARIA COMPACT TOP, PLOČA ZA UMIVAONIK, 90x52x13, S NOSAČIMA	ACT90T
1718005	ARIA COMPACT BASE, LADICA + POKROVNA PLOČA, 90x50x26	ACB90T
KOMPOZICIJA ARIA COMPACT TOBACCO 120 cm		
1716009	ARIA COMPACT TOP, PLOČA ZA UMIVAONIK, 102x52x13, S NOSAČIMA	ACT120T
1717005	ARIA COMPACT TOP, PLOČA ZA UMIVAONIK, IZREZ ZA RUČNIK, 120x52x13, S NOSAČIMA	ACTRR120T
1718009	ARIA COMPACT BASE, LADICA + POKROVNA PLOČA, 120x50x26	ACB120T
KOMPOZICIJA ARIA COMPACT TOBACCO 140 cm		
1716013	ARIA COMPACT TOP, PLOČA ZA UMIVAONIK, 140x52x13, S NOSAČIMA	ACT140T
1717001	ARIA COMPACT TOP, PLOČA ZA UMIVAONIK, IZREZ ZA RUČNIK, 140x52x13, S NOSAČIMA	ACTRR140T
1718013	ARIA COMPACT BASE, LADICA + POKROVNA PLOČA, 140x50x26	ACB140T



GLAVNE KARAKTERISTIKE:

- Čvrstoća, homogenost i dugotrajnost
- Otpornost na ogrebotine, toplinu i vlagu
- Antibakterijski sa hipoalergenim svojstvima
- Jednostavnost održavanja i čišćenja

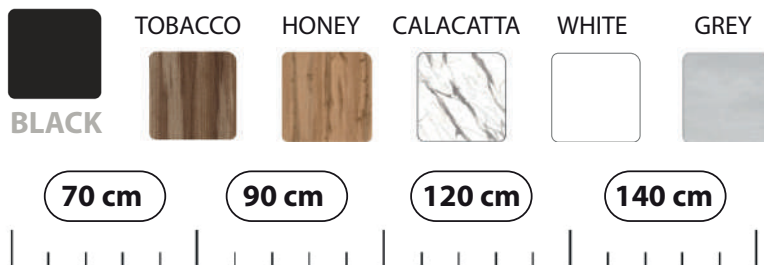

VOKEL ŠIFRA	OPIS	ART.
KOMPOZICIJA ARIA COMPACT BLACK 70 cm		
1716002	ARIA COMPACT TOP, PLOČA ZA UMIVAONIK, 70x52x13, S NOSAČIMA	ACT70B
1718002	ARIA COMPACT BASE, LADICA + POKROVNA PLOČA, 70x50x26	ACB70B
KOMPOZICIJA ARIA COMPACT BLACK 90 cm		
1716006	ARIA COMPACT TOP, PLOČA ZA UMIVAONIK, 90x52x13, S NOSAČIMA	ACT90B
1718006	ARIA COMPACT BASE, LADICA + POKROVNA PLOČA, 90x50x26	ACB90B
KOMPOZICIJA ARIA COMPACT BLACK 120 cm		
1716011	ARIA COMPACT TOP, PLOČA ZA UMIVAONIK, 120x52x13, S NOSAČIMA	ACT120B
1717006	ARIA COMPACT TOP, PLOČA ZA UMIVAONIK, IZREZ ZA RUČNIK, 120x52x13, S NOSAČIMA	ACTRR120B
1718010	ARIA COMPACT BASE, LADICA + POKROVNA PLOČA, 120x50x26	ACB120B
KOMPOZICIJA ARIA COMPACT BLACK 140 cm		
1716014	ARIA COMPACT TOP, PLOČA ZA UMIVAONIK, 140x52x13, S NOSAČIMA	ACT140B
1717002	ARIA COMPACT TOP, PLOČA ZA UMIVAONIK, IZREZ ZA RUČNIK, 140x52x13, S NOSAČIMA	ACTRR140B
1718014	ARIA COMPACT BASE, LADICA + POKROVNA PLOČA, 140x50x26	ACB140B



GLAVNE KARAKTERISTIKE:

- Čvrstoća, homogenost i dugotrajnost
- Otpornost na ogrebotine, toplinu i vlagu
- Antibakterijski sa hipoalergenim svojstvima
- Jednostavnost održavanja i čišćenja



VOKEL ŠIFRA	OPIS	ART.
KOMPOZICIJA ARIA COMPACT HONEY 70 cm		
1716003	ARIA COMPACT TOP, PLOČA ZA UMIVAONIK, 70x52x13, S NOSAČIMA	ACT70H
1718003	ARIA COMPACT BASE, LADICA + POKROVNA PLOČA, 70x50x26	ACB70H
KOMPOZICIJA ARIA COMPACT HONEY 90 cm		
1716007	ARIA COMPACT TOP, PLOČA ZA UMIVAONIK, 90x52x13, S NOSAČIMA	ACT90H
1718007	ARIA COMPACT BASE, LADICA + POKROVNA PLOČA, 90x50x26	ACB90H
KOMPOZICIJA ARIA COMPACT HONEY 120 cm		
1716010	ARIA COMPACT TOP, PLOČA ZA UMIVAONIK, 120x52x13, S NOSAČIMA	ACT120H
1717007	ARIA COMPACT TOP, PLOČA ZA UMIVAONIK, IZREZ ZA RUČNIK, 120x52x13, S NOSAČIMA	ACTRR120H
1718011	ARIA COMPACT BASE, LADICA + POKROVNA PLOČA, 120x50x26	ACB120H
KOMPOZICIJA ARIA COMPACT HONEY 140 cm		
1716015	ARIA COMPACT TOP, PLOČA ZA UMIVAONIK, 140x52x13, S NOSAČIMA	ACT140H
1717003	ARIA COMPACT TOP, PLOČA ZA UMIVAONIK, IZREZ ZA RUČNIK, 140x52x13, S NOSAČIMA	ACTRR140H
1718015	ARIA COMPACT BASE, LADICA + POKROVNA PLOČA, 140x50x26	ACB140H



GLAVNE KARAKTERISTIKE:

- Čvrstoća, homogenost i dugotrajnost
- Otpornost na ogrebotine, toplinu i vlagu
- Antibakterijski sa hipoalergenim svojstvima
- Jednostavnost održavanja i čišćenja

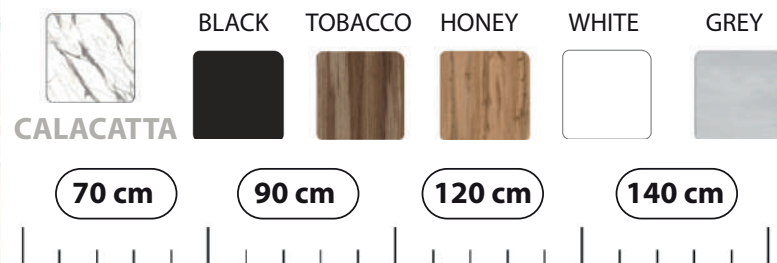

VOKEL ŠIFRA	OPIS	ART.
KOMPOZICIJA ARIA COMPACT CALACATTA 70 cm		
1716004	ARIA COMPACT TOP, PLOČA ZA UMIVAONIK, 70x52x13, S NOSAČIMA	ACT70C
1718004	ARIA COMPACT BASE, LADICA + POKROVNA PLOČA, 70x50x26	ACB70C
KOMPOZICIJA ARIA COMPACT CALACATTA 90 cm		
1716008	ARIA COMPACT TOP, PLOČA ZA UMIVAONIK, 90x52x13, S NOSAČIMA	ACT90C
1718008	ARIA COMPACT BASE, LADICA + POKROVNA PLOČA, 90x50x26	ACB90C
KOMPOZICIJA ARIA COMPACT CALACATTA 120 cm		
1716012	ARIA COMPACT TOP, PLOČA ZA UMIVAONIK, 120x52x13, S NOSAČIMA	ACT120C
1717008	ARIA COMPACT TOP, PLOČA ZA UMIVAONIK, IZREZ ZA RUČNIK, 120x52x13, S NOSAČIMA	ACTRR120C
1718012	ARIA COMPACT BASE, LADICA + POKROVNA PLOČA, 120x50x26	ACB120C
KOMPOZICIJA ARIA COMPACT CALACATTA 140 cm		
1716016	ARIA COMPACT TOP, PLOČA ZA UMIVAONIK, 140x52x13, S NOSAČIMA	ACT140C
1717004	ARIA COMPACT TOP, PLOČA ZA UMIVAONIK, IZREZ ZA RUČNIK, 140x52x13, S NOSAČIMA	ACTRR140C
1718016	ARIA COMPACT BASE, LADICA + POKROVNA PLOČA, 140x50x26	ACB140C



GLAVNE KARAKTERISTIKE:

- Čvrstoća, homogenost i dugotrajnost
- Otpornost na ogrebotine, toplinu i vlagu
- Antibakterijski sa hipoalergenim svojstvima
- Jednostavnost održavanja i čišćenja



VOKEL ŠIFRA	OPIS	ART.
KOMPOZICIJA ARIA COMPACT WHITE 70 cm		
1716021	ARIA COMPACT TOP, PLOČA ZA UMIVAONIK, 70x52x13, S NOSAČIMA	ACT70WH
1718025	ARIA COMPACT BASE, LADICA + POKROVNA PLOČA, 70x50x26	ACB70WH
KOMPOZICIJA ARIA COMPACT WHITE 90 cm		
1716022	ARIA COMPACT TOP, PLOČA ZA UMIVAONIK, 90x52x13, S NOSAČIMA	ACT90WH
1718026	ARIA COMPACT BASE, LADICA + POKROVNA PLOČA, 90x50x26	ACB90WH
KOMPOZICIJA ARIA COMPACT WHITE 120 cm		
1716023	ARIA COMPACT TOP, PLOČA ZA UMIVAONIK, 120x52x13, S NOSAČIMA	ACT120WH
1718027	ARIA COMPACT BASE, LADICA + POKROVNA PLOČA, 120x50x26	ACB120WH
KOMPOZICIJA ARIA COMPACT WHITE 140 cm		
1716024	ARIA COMPACT TOP, PLOČA ZA UMIVAONIK, 140x52x13, S NOSAČIMA	ACT140WH
1718028	ARIA COMPACT BASE, LADICA + POKROVNA PLOČA, 140x50x26	ACB140WH



GLAVNE KARAKTERISTIKE:

- Čvrstoća, homogenost i dugotrajnost
- Otpornost na ogrebotine, toplinu i vlagu
- Antibakterijski sa hipoalergenim svojstvima
- Jednostavnost održavanja i čišćenja

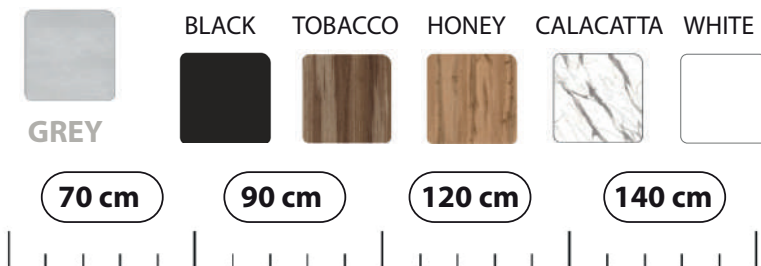

VOKEL ŠIFRA	OPIS	ART.
KOMPOZICIJA ARIA COMPACT GREY 70 cm		
1716017	ARIA COMPACT TOP, PLOČA ZA UMIVAONIK, 70x52x13, S NOSAČIMA	ACT70GR
1718021	ARIA COMPACT BASE, LADICA + POKROVNA PLOČA, 70x50x26	ACB70GR
KOMPOZICIJA ARIA COMPACT GREY 90 cm		
1716018	ARIA COMPACT TOP, PLOČA ZA UMIVAONIK, 90x52x13, S NOSAČIMA	ACT90GR
1718022	ARIA COMPACT BASE, LADICA + POKROVNA PLOČA, 90x50x26	ACB90GR
KOMPOZICIJA ARIA COMPACT GREY 120 cm		
1716019	ARIA COMPACT TOP, PLOČA ZA UMIVAONIK, 120x52x13, S NOSAČIMA	ACT120GR
1718023	ARIA COMPACT BASE, LADICA + POKROVNA PLOČA, 120x50x26	ACB120GR
KOMPOZICIJA ARIA COMPACT GREY 140 cm		
1716020	ARIA COMPACT TOP, PLOČA ZA UMIVAONIK, 140x52x13, S NOSAČIMA	ACT140GR
1718024	ARIA COMPACT BASE, LADICA + POKROVNA PLOČA, 140x50x26	ACB140GR



RUČKICA 001

ŠIFRA VOKEL	BOJA	DULJINA (mm)
1718017	CHROM	416



RUČKICA 004

ŠIFRA VOKEL	BOJA	DULJINA (mm)
1718020	SILVER MAT	416



RUČKICA 002

ŠIFRA VOKEL	BOJA	DULJINA (mm)
1718018	GOLD	416



RUČKICA 003

ŠIFRA VOKEL	BOJA	DULJINA (mm)
1718019	BLACK	416

Biamante





Ø 70

Vokel šifra	Opis	Artikal
1720026	OGLEDALO AURELIA BLACK S LED RASVJETOM	BS-M2231B

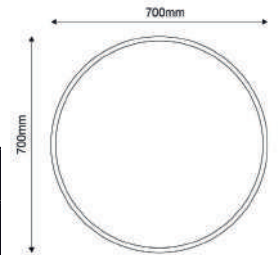

Ø 70

Vokel šifra	Opis	Artikal
1720027	OGLEDALO AURELIA GOLD S LED RASVJETOM	BS-M2231Y

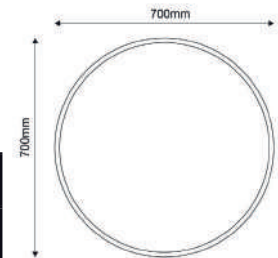

Ø 70

Vokel šifra	Opis	Artikal
1720028	OGLEDALO AURELIA WOOD S LED RASVJETOM	BS-M2231W

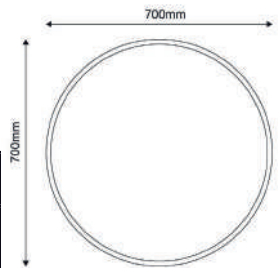

80x60 cm

Vokel šifra	Opis	Artikal
1720003	OGLEDALO NUBE 80x60 S LED RASVJETOM	S-4583

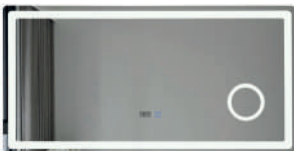
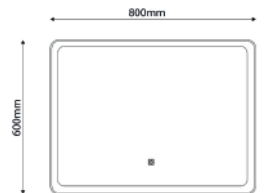

120x60 cm

Vokel šifra	Opis	Artikal
1720004	OGLEDALO LIGERO S POVEĆALOM 3X I LED RASVJETOM	S-3612

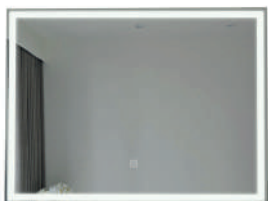

80x60 cm

Vokel šifra	Opis	Artikal
1720005	OGLEDALO VENTO S LED RASVJETOM	S-4635

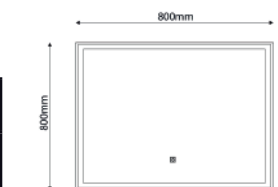



Ø 60

Vokel šifra	Opis	Artikal
1720007	OGLEDALO AMELIE GOLD S LED RASVJETOM	SP-N5817G-60

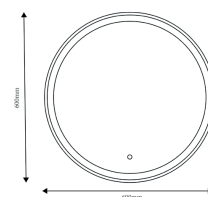

Ø 60

Vokel šifra	Opis	Artikal
1720031	OGLEDALO AMELIE BRONZE S LED RASVJETOM	SP-N58178BR-60

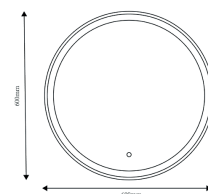

Ø 60

Vokel šifra	Opis	Artikal
1720019	OGLEDALO AMELIE BLACK, S LED RASVJETOM	SP-N5817B-60

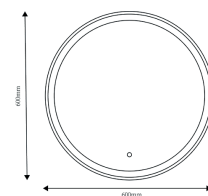

Ø 80

Vokel šifra	Opis	Artikal
1720008	OGLEDALO VIVIEN GOLD S LED RASVJETOM	SP-N5817G-80

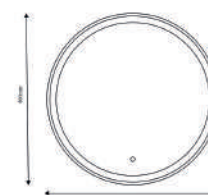

Ø 80

Vokel šifra	Opis	Artikal
1720032	OGLEDALO VIVIEN BRONZE S LED RASVJETOM	SP-N58178BR-80

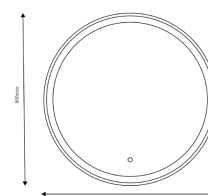

Ø 80

Vokel šifra	Opis	Artikal
1720020	OGLEDALO VIVIEN BLACK, S LED RASVJETOM	SP-N5817B-80

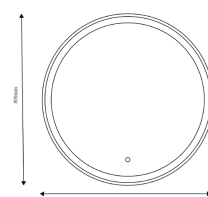



Ø 60

Vokel šifra	Opis	Artikal
1720010	OGLEDALO CAROL S LED RASVJETOM	S-4601-60

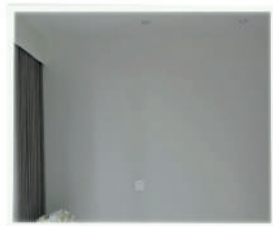
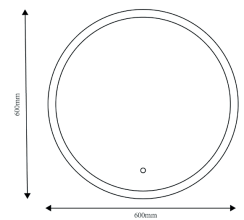

70x70

Vokel šifra	Opis	Artikal
1720011	OGLEDALO KATHERINE S LED RASVJETOM	S-4604

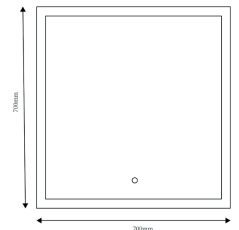

Ø 80

Vokel šifra	Opis	Artikal
1720021	OGLEDALO AMBER, S LED RASVJETOM	S-4601-80

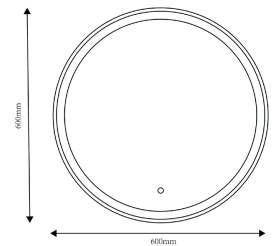

60x100

Vokel šifra	Opis	Artikal
1720022	OGLEDALO NATALIE BLACK S LED RASVJETOM	BS-5001B

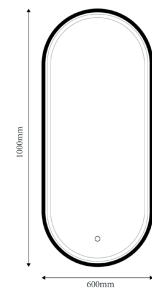

60 x 100

Vokel šifra	Opis	Artikal
1720023	OGLEDALO NATALIE GOLD, S LED RASVJETOM	BS-5001G

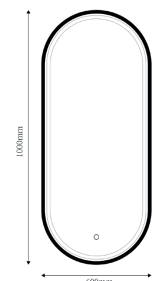



600 x 800

Vokel šifra	Opis	Artikal
1720024	OGLEDALO LILI S LED RASVJETOM	BS-M2235

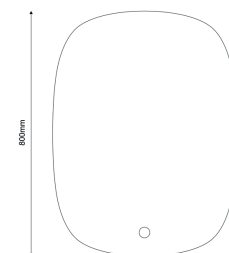

800 x 800

Vokel šifra	Opis	Artikal
1720025	OGLEDALO LILI S LED RASVJETOM	BS-M2236

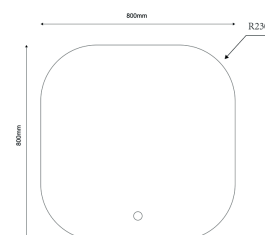

Ø 70

Vokel šifra	Opis	Artikal
1720029	OGLEDALO OLIVIA GOLD S LED RASVJETOM	BS-M2232G

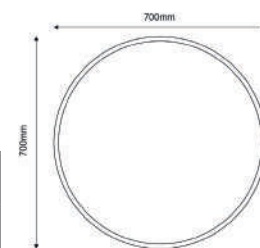

Ø 70

Vokel šifra	Opis	Artikal
1720030	OGLEDALO OLIVIA BLACK S LED RASVJETOM	BS-M2232B

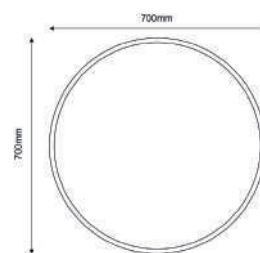

Ø 80

Vokel šifra	Opis	Artikal
1720033	OGLEDALO BIANCA WHITE S LED RASVJETOM	BS-M2250W-80

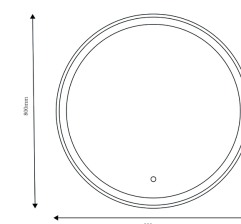



Ø 60

Vokel šifra	Opis	Artikal
1720034	OGLEDALO BIANCA WHITE S LED RASVJETOM	BS-M2250W-60

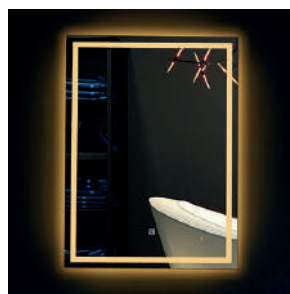
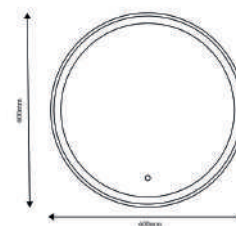

60x80

Vokel šifra	Opis	Artikal
1720041	OGLEDALO HELEN S TOPLOM LED RASVJETOM	BS-M2111

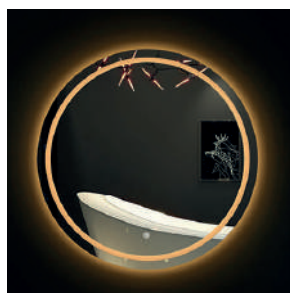
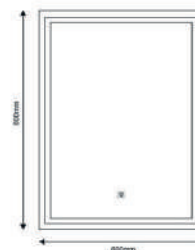

Ø 80

Vokel šifra	Opis	Artikal
1720042	OGLEDALO LORRA S TOPLOM LED RASVJETOM	BS-M2126

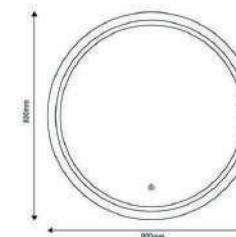

SVJETILJKA LUSI

Vokel šifra	Opis	Artikal
1720018	SVJETILJKA LUSI 42cm	BS-8210



SVJETILJKA LUSI GOLD

Vokel šifra	Opis	Artikal
1720039	SVJETILJKA LUSI GOLD 40 cm	JQ-8210
1720040	SVJETILJKA LUSI GOLD 50 cm	JQ-8210

SVJETILJKA LUMEN BLACK



Vokel šifra	Opis	Artikal
1720037	SVJETILJKA LUMEN BLACK 42 cm	JQ-6610
1720038	SVJETILJKA LUMEN BLACK52 cm	JQ-6610



APURSIL

PRVO ČIŠĆENJE:

Prilikom odstranjivanja zaštitne folije s ogledala, preporučuje se korištenje sredstva Apursil ili nekog sličnog.



DUPLI TOUCH KONTROLER

Vokel šifra	Opis
1720035	LED TRAKA + ODMAGLJIVANJE

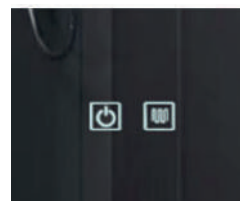

TOUCH KONTROLER

Vokel šifra	Opis
1720036	LED TRAKA

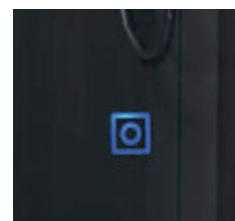

UMIVAONICI OD PRIRODNOG KAMENA

Svaki umivaonik je unikatan proizvod svojom bojom i strukturom. U procesu proizvodnje koriste se najmoderniji CNC strojevi za obradu kamena te se do krajnjeg izgleda dorađuje ručno. Proizvod je namijenjen za unutarnju upotrebu.

GARDEN

VOKEL ŠIFRA	OPIS	DIMENZIJA
1721001	UMIVAONIK GARDEN - HERSTONE	40x60 cm



ROOT

VOKEL ŠIFRA	OPIS	DIMENZIJA
1721002	UMIVAONIK ROOT - HERSTONE	35x50 cm



HARMONY

VOKEL ŠIFRA	OPIS	DIMENZIJA
1721003	UMIVAONIK HARMONY - HERSTONE	40x40 cm



BLOOM

VOKEL ŠIFRA	OPIS	DIMENZIJA
1721004	UMIVAONIK BLOOM - HERSTONE	ø 40 cm

ECOLIGHT PLUS

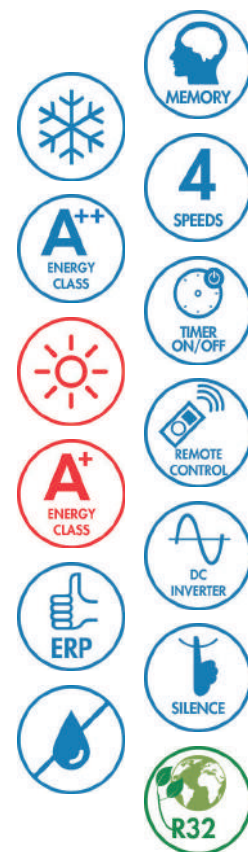

Nizak utjecaj na okoliš, visoka energetska učinkovitost, udobnost i tišina glavni su plusevi ove serije split klima uređaja s istosmjernim inverterom ARGO ECOLIGHT PLUS: idealni za pojedinačnu i višestruku primjenu, kombiniraju maksimalnu udobnost s niskom potrošnjom.

- Hlađenje, grijanje, odvlaživanje i ventilator
- DC Inverter tehnologija, maksimalna udobnost, minimum potrošnja
- Programabilno vrijeme za uključivanje/isključivanje
- R32, ekološki plin s malim utjecajem na globalno zagrijavanje
- 4 brzine ventilatora: Turbo, High, Medium, Low

VOKEL ŠIFRA	OPIS	SNAGA GRIJANJA (kW)	SNAGA HLAĐENJA (kW)	ŠIFRA ARTIKLA
1418121	ECOLIGHT PLUS 9000 - UNUTARNJA JEDINICA	2,8	2,5	398000798
1418122	ECOLIGHT PLUS 9000 - VANJSKA JEDINICA	2,8	2,5	398000799
1418123	ECOLIGHT PLUS 12000 - UNUTARNJA JEDINICA	3,4	3,2	398000800
1418124	ECOLIGHT PLUS 12000 - VANJSKA JEDINICA	3,4	3,2	398000801
1418125	ECOLIGHT PLUS 18000 - UNUTARNJA JEDINICA	5,2	4,6	398000802
1418126	ECOLIGHT PLUS 18000 - VANJSKA JEDINICA	5,2	4,6	398000803
1418127	ECOLIGHT PLUS 24000 - UNUTARNJA JEDINICA	6,5	6,2	398000804
1418128	ECOLIGHT PLUS 24000 - VANJSKA JEDINICA	6,5	6,2	398000805

MODEL		VOKEL ŠIFRA ECOLIGHT PLUS 9		VOKEL ŠIFRA ECOLIGHT PLUS 12	
Unutarnja jedinica		1418121 ECOLIGHT PLUS 9000 UI		1418123 ECOLIGHT PLUS 12000 UI	
Vanjska jedinica		1418122 ECOLIGHT PLUS 9000 UE		1418124 ECOLIGHT PLUS 12000 UE	
		Hlađenje	Grijanje	Hlađenje	Grijanje
Kapacitet (nominalni-minimalni-maksimalni) (EN14511)	kW	2,50 (0,50-3,25)	2,80 (0,50-3,50)	3,20 (0,90-2,60)	3,40 (0,90-4,00)
	BTU/h	9000	9000	12000	12000
EER / COP (EN14511)		3,47	3,73	3,23	3,71
Dizajn (Pdesign c / Pdesign h) (prosje/toplo/hladno) (EN14825)	kW	2,5	2,5/2,6/-	3,2	2,7/2,8/-
Omjer učinkovitosti SEER / SCOP (prosje/toplo/hladno) (EN14825)		6,5	4,0/5,1/-	6,1	4,0/5,1/-
Energetski razred		A++	A+/A+++/-	A++	A+/A+++/-
Godišnja potrošnja energije C/H (prosje/toplo/hladno)	kWh/annum	135	875/714/-	184	945/769/-
Unutarnji protok zraka	m ³ /h	500-470-390-270		590-520-400-320	
Odvlaživanje	l/h	0,6		1,4	
Brzina ventilatora (unutarnji/vanjski)	n°	4/1		4/1	
Zvučni pritisak - unutarnji	dB(A)	38-36-32-22		41-37-33-26	
Zvučni pritisak - vanjski	dB(A)	51		51	
Snaga zvuka - unutarnji	dB(A)	55-48-44-34		56-49-45-38	
Snaga zvuka - vanjski	dB(A)	62		64	
Napajanje	V/Ph/Hz	220-240~/1/50		220-240~/1/50	
Snaga izlazne struje	kW	0,720	0,750	0,991	0,916
Model kompresora		Rotary DC Inverter		Rotary DC Inverter	
Vrsta rashladnog sredstva		R32		R32	
Količina rashladnog sredstva	kg/T.CO ₂ eq.	0,5/0,338		0,55/0,371	
Promjer cijevi za tekućinu	mm (")	6,35 (1/4")		6,35 (1/4")	
Promjer cijevi za plin	mm (")	9,52 (3/8")		9,52 (3/8")	
Max. duljina cijevi sa standardnim nabojem plina	m	3-5		3-5	
Max. duljina cijevi s dodatnim nabojem	m	15		15	
Dodatna napunjenost rashladnog sredstva	g/m	16		16	
Max. visina između jedinica (Vanjski na vrhu)	m	10		10	
Max. visina između jedinica (Unutarnji na vrhu)	m	10		10	
Neto dimenzija Unutarnja (visina/dužina/dubina)	mm	251/696/190		251/770/190	
Neto dimenzija Vanjska (visina/dužina/dubina)	mm	550/732/330		550/732/330	
Neto težina Unutarnja / Vanjska	kg	7,5/25		8,0/25	

GRANICE RADA (vanjska temperatura):

Hlađenje: +15 °C ~ +43 °C

Grijanje: -15°C ~ +24 °C

RASPON POSTAVKI UNUTARNJE TEMPERATURE: 16-30 °C

MODEL		VOKEL ŠIFRA ECOLIGHT PLUS 18		VOKEL ŠIFRA ECOLIGHT PLUS 24	
Unutarnja jedinica		1418125 ECOLIGHT PLUS 18000 UI		1418127 ECOLIGHT PLUS 24000 UI	
Vanjska jedinica		1418126 ECOLIGHT PLUS 18000 UE		1418128 ECOLIGHT PLUS 24000 UE	
		Hlađenje	Grijanje	Hlađenje	Grijanje
Kapacitet (nominalni-minimalni-maksimalni) (EN14511)	kW	4,60 (1,00-5,30)	5,20 (1,00-5,65)	6,20 (1,60-6,90)	6,50 (1,30-7,90)
	BTU/h	18000	18000	24000	24000
EER / COP (EN14511)		3,40	3,88	3,50	3,95
Dizajn (Pdesign c / Pdesign h) (prosje/toplo/hladno) (EN14825)	kW	4,6	3,7/3,6/-	6,2	4,7/4,7/-
Omjer učinkovitosti SEER / SCOP (prosje/toplo/hladno) (EN14825)		6,4	4,0/5,1/-	6,8	4,0/5,1/-
Energetski razred		A++	A+/A+++/-	A++	A+/A+++/-
Godišnja potrošnja energije C/H (prosje/toplo/hladno)	kWh/annum	251	1295/988/-	319	1290/1645/-
Unutarnji protok zraka	m ³ /h	850-800-700-600		1100-950-750-650	
Odvlaživanje	l/h	1,8		1,8	
Brzina ventilatora (unutarnji/vanjski)	n°	4/1		4/1	
Zvučni pritisak - unutarnji	dB(A)	44-42-38-34		47-44-38-35	
Zvučni pritisak - vanjski	dB(A)	55		58	
Snaga zvuka - unutarnji	dB(A)	54-52-48-44		61-58-52-49	
Snaga zvuka - vanjski	dB(A)	63		67	
Napajanje	V/Ph/Hz	220-240~/1/50		220-240~/1/50	
Snaga izlazne struje	kW	1,355	1,340	1,771	1,646
Model kompresora		Rotary DC Inverter		Rotary DC Inverter	
Vrsta rashladnog sredstva		R32		R32	
Količina rashladnog sredstva	kg/T.CO ₂ eq.	0,75/0,506		1,3/0,878	
Promjer cijevi za tekućinu	mm (")	6,35 (1/4")		6,35 (1/4")	
Promjer cijevi za plin	mm (")	9,52 (3/8")		12,7 (1/2")	
Max. duljina cijevi sa standardnim nabojem plina	m	3-5		3-5	
Max. duljina cijevi s dodatnim nabojem	m	25		25	
Dodatna napunjenost rashladnog sredstva	g/m	16		16	
Max. visina između jedinica (Vanjski na vrhu)	m	10		10	
Max. visina između jedinica (Unutarnji na vrhu)	m	10		10	
Neto dimenzija Unutarnja (visina/dužina/dubina)	mm	300/972/225		325/1081/248	
Neto dimenzija Vanjska (visina/dužina/dubina)	mm	550/732/330		555/873/376	
Neto težina Unutarnja / Vanjska	kg	13,5/26,5		16,5/36,5	

GRANICE RADA (vanjska temperatura):

Hlađenje: +15 °C ~ +43 °C

Grijanje: -15°C ~ +24 °C

RASPON POSTAVKI UNUTARNJE TEMPERATURE: 16-30 °C

X3I ECO PLUS



WIFI

- Možete kontrolirati udobnost svog doma kada i gdje želite.

I FEEL FUNKCIJA

- Senzor unutar daljinskog upravljača osjeća temperaturu u okolini i prenosi signal unutarnjoj jedinici. Na taj način unutarnja jedinica može podesiti volumen i temperaturu protoka zraka kako bi pružila udobnost točno na mjestu gdje je daljinski upravljač postavljen.

SUSTAV ZA PROČIŠĆAVANJE ZRAKA

- Omogućuje učinkovitu sterilizaciju zraka uklanjajući preko 90% bakterija. Uklanja mirise.
- Kvaliteta zraka je poboljšana zahvaljujući emisiji puno negativnih iona kisika.

INTELIGENTNO AUTOMATSKO PONOVRNO POKRETANJE

- Nakon nestanka struje, jedinica se automatski ponovno pokreće zadržavajući zadnje postavke funkcije. (funkcija memorije)

LAGANO POKRETANJE

- Potrošnja energije pri pokretanju smanjena je na nižu kako ne bi ometala korištenje drugih uređaja.

VOKEL ŠIFRA	OPIS	SNAGA GRIJANJA (kW)	SNAGA HLAĐENJA (kW)	ŠIFRA ARTIKLA
1418142	X3I ECO PLUS 35 HL WF - UNUTARNJA JEDINICA	3,81	3,51	398000819
1418143	X3I ECO PLUS 35 SH - VANJSKA JEDINICA	3,81	3,51	398000820
1418144	X3I ECO PLUS 52 HL WF - UNUTARNJA JEDINICA	5,6	5,2	398000821
1418145	X3I ECO PLUS 52 SH - VANJSKA JEDINICA	5,6	5,2	398000822
1418146	X3I ECO PLUS 70 HL WF - UNUTARNJA JEDINICA	7,8	7,1	398000823
1418147	X3I ECO PLUS 70 SH - VANJSKA JEDINICA	7,8	7,1	398000824

MODEL		VOKEL ŠIFRA X3I ECO PLUS 35		VOKEL ŠIFRA X3I ECO PLUS 52	
Unutarnja jedinica		1418142 X3I ECO PLUS 35 HL WF		1418144 X3I ECO PLUS 52 HL WF	
Vanjska jedinica		1418143 X3I ECO PLUS 35 SH		1418145 X3I ECO PLUS 52 SH	
		Hlađenje	Grijanje	Hlađenje	Grijanje
Kapacitet (nominalni-minimalni-maksimalni) (EN14511)	kW	3,51 (0,90-4,40)	3,81 (0,90-4,70)	5,20 (1,00-6,10)	5,60(1,10-6,60)
	BTU/h	12000	1300	17800	19100
EER / COP (EN14511)		3,65	4,00	3,30	3,90
Dizajn (Pdesign c / Pdesign h) (prosje/toplo/hladno) (EN14825)	kW	3,5	3,2/3,3/4,5	5,2	4,2/4,3/5,0
Omjer učinkovitosti SEER / SCOP (prosje/toplo/hladno) (EN14825)		7,1	4,1/5,2/3,1	7,1	4,2/5,7/3,4
Energetski razred		A++	A+/A++/B	A++	A+/A++/A
Godišnja potrošnja energije C/H (prosje/toplo/hladno)	kWh/annum	173	1093/888/3048	256	1400/1056/3088
Unutarnji protok zraka	m ³ /h	700-650-600-540-480-420-360		800-750-680-610-570-520-460	
Odvlaživanje	l/h	1,4		1,9	
Brzina ventilatora (unutarnji/vanjski)	n°	7/2		7/2	
Zvučni pritisak - unutarnji	dB(A)	42-38-35-32-29-26-25		44-43-41-38-36-34-30	
Zvučni pritisak - vanjski	dB(A)	52		56	
Snaga zvuka - unutarnji	dB(A)	57-50-47-44-41-38-37		60-56-54-51-49-47-43	
Snaga zvuka - vanjski	dB(A)	63		65	
Napajanje	V/Ph/Hz	220-240V~/1/50		220-240V~/0/1/50	
Snaga izlazne struje	kW	0,962 (0,22-1,40)	0,953 (0,22-1,55)	1,576 (0,10-2,35)	1,436 (0,18-2,40)
Model kompresora		Rotary DC Inverter		Rotary DC Inverter	
Vrsta rashladnog sredstva		R32		R32/675	
Količina rashladnog sredstva	kg/T.CO ₂ eq.	0,57/0,384		0,82/0,553	
Promjer cijevi za tekućinu	mm (")	6,35 (1/4")		6,35 (1/4")	
Promjer cijevi za plin	mm (")	9,52 (3/8")		12,7 (1/2")	
Max. duljina cijevi sa standardnim nabojem plina	m	3-5		3-5	
Max. duljina cijevi s dodatnim nabojem	m	15		25	
Dodatna napunjenost rashladnog sredstva	g/m	16		16	
Max. visina između jedinica (Vanjski na vrhu)	m	10		10	
Max. visina između jedinica (Unutarnji na vrhu)	m	10		10	
Neto dimenzija Unutarnja (visina/dužina/dubina)	mm	289/845/209		300/970/224	
Neto dimenzija Vanjska (visina/dužina/dubina)	mm	555/732/330		555/802/350	
Neto težina Unutarnja / Vanjska	kg	11/24,5		13/30,5	

GRANICE RADA (vanjska temperatura):

Hlađenje: -15 °C ~ +43 °C

Grijanje: -15°C ~ +24 °C

RASPON POSTAVKI UNUTARNJE TEMPERATURE: 16-30 °C

MODEL		VOKEL ŠIFRA X3I ECO PLUS 70	
Unutarnja jedinica		1418146 X3I ECO PLUS 70 HL WF	
Vanjska jedinica		1418147 X3I ECO PLUS 70 SH	
		Hlađenje	Grijanje
Kapacitet (nominalni-minimalni-maksimalni) (EN14511)	kW	7,10 (2,00-8,85)	7,80 (1,80-9,45)
	BTU/h	24200	26600
EER / COP (EN14511)		3,50	3,90
Dizajn (Pdesign c / Pdesign h) (prosje/toplo/hladno) (EN14825)	kW	7,1	5,6/5,7/6,3
Omjer učinkovitosti SEER / SCOP (prosje/toplo/hladno) (EN14825)		7,00	4,2/5,4/3,4
Energetski razred		A++	A+/A+++/A
Godišnja potrošnja energije C/H (prosje/toplo/hladno)	kWh/annum	355	1867/1478/3891
Unutarnji protok zraka	m ³ /h	1250-1100-1000-950-900-850-800	
Odvlaživanje	l/h	2,4	
Brzina ventilatora (unutarnji/vanjski)	n°	7/2	
Zvučni pritisak - unutarnji	dB(A)	48-44-41-40-38-36-33	
Zvučni pritisak - vanjski	dB(A)	59	
Snaga zvuka - unutarnji	dB(A)	64-59-56-55-53-51-48	
Snaga zvuka - vanjski	dB(A)	70	
Napajanje	V/Ph/Hz	220-240V~/1/50	
Snaga izlazne struje	kW	2,030 (0,45-2,90)	2,000 (0,35-3,00)
Model kompresora		Rotary DC Inverter	
Vrsta rashladnog sredstva		R32/675	
Količina rashladnog sredstva	kg/T.CO ₂ eq.	1,5/1,0125	
Promjer cijevi za tekućinu	mm (")	6,35 (1/4")	
Promjer cijevi za plin	mm (")	15,88 (5/8")	
Max. duljina cijevi sa standardnim nabojem plina	m	3-5	
Max. duljina cijevi s dodatnim nabojem	m	25	
Dodatna napunjenost rashladnog sredstva	g/m	40	
Max. visina između jedinica (Vanjski na vrhu)	m	10	
Max. visina između jedinica (Unutarnji na vrhu)	m	10	
Neto dimenzija Unutarnja (visina/dužina/dubina)	mm	325/1078/246	
Neto dimenzija Vanjska (visina/dužina/dubina)	mm	660/958/402	
Neto težina Unutarnja / Vanjska	kg	16/41,5	

GRANICE RADA (vanjska temperatura):

Hlađenje: -15 °C ~ +43 °C

Grijanje: -15°C ~ +24 °C

RASPON POSTAVKI UNUTARNJE TEMPERATURE: 16-30 °C

X3I ECO PLUS ZIDNA -25°C

- single split



(Standard)
Infracrveni daljinski
upravljač



(Opcionalni)
Žičani upravljač sa
tjednim mjeračem
vremena



- A⁺⁺ Hlađenje
- A⁺ Grijanje (prosječna sezona)
- A⁺⁺⁺ Grijanje (toplija sezona)

VOKEL ŠIFRA	OPIS	SMAGA GRIJANJA (kW)	SNAGA HLAĐENJA (kW)	ŠIFRA ARTIKLA
1418181	X3I ECO PLUS 35 HL WF LH - UNUTARNJA JEDINICA	3,81	3,51	398000854
1418182	X3I ECO PLUS 35 SH LH- VANJSKA JEDINICA	3,81	3,51	398000855
1418183	X3I ECO PLUS 52 HL WF LH- UNUTARNJA JEDINICA	5,60	5,20	398000864
1418184	X3I ECO PLUS 52 SH LH - VANJSKA JEDINICA	5,60	5,20	398000865
1418185	X3I ECO PLUS 71 HL WF LH - UNUTARNJA JEDINICA	7,80	7,10	398000866
1418186	X3I ECO PLUS 71 SH LH- VANJSKA JEDINICA	7,80	7,10	398000867

Ovaj raspon može raditi u grijanju čak i pri niskim vanjskim temperaturama, do -25 stupnjeva Celzijusa, zahvaljujući grijačem elementu na dnu vanjske jedinice. Pogodna je za oštre klimatske uvjete

MODEL		VOKEL ŠIFRA X3I ECO PLUS 35 LH	
Unutarnja jedinica		1418181 X3I ECO PLUS 35 HL WF LH	
Vanjska jedinica		1418182 X3I ECO PLUS 35 SH LH	
		Hlađenje	Grijanje
Kapacitet (nominalni-minimalni-maksimalni) (EN14511)	kW	3,51 (0,90-4,40)	3,81 (0,90-4,70)
	BTU/h	12000	13000
EER / COP (EN14511)		3,65	4,00
Dizajn (Pdesign c / Pdesign h) (prosje/toplo/hladno) (EN14825)	kW	3,5	3,2/3,3/4,5
Omjer učinkovitosti SEER / SCOP (prosje/toplo/hladno) (EN14825)		7,1	4,1/5,2/3,1
Energetski razred		A++	A+/A++/A
Godišnja potrošnja energije C/H (prosje/toplo/hladno)	kWh/annum	173	1093/888/3048
Unutarnji protok zraka	m ³ /h	700-650-600-540-480-420-360	
Odvlaživanje	l/h	1,4	
Brzina ventilatora (unutarnji/vanjski)	n°	7/2	
Zvučni pritisak - unutarnji	dB(A)	42-38-35-32-29-27-25	
Zvučni pritisak - vanjski	dB(A)	52	
Snaga zvuka - unutarnji	dB(A)	57-50-47-44-41-39-37	
Snaga zvuka - vanjski	dB(A)	63	
Napajanje	V/Ph/Hz	220-240V~/1/50	
Snaga izlazne struje	kW	0,962 (0,22-1,40)	0,953 (0,22-1,55)
Model kompresora		Rotary DC Inverter	
Vrsta rashladnog sredstva		R32	
Količina rashladnog sredstva	kg/T.CO ₂ eq.	0,57/0,384	
Promjer cijevi za tekućinu	mm (")	6,35 (1/4")	
Promjer cijevi za plin	mm (")	9,52 (3/8")	
Max. duljina cijevi sa standardnim nabojem plina	m	3-5	
Max. duljina cijevi s dodatnim nabojem	m	20	
Dodatna napunjenost rashladnog sredstva	g/m	16	
Max. visina između jedinica (Vanjski na vrhu)	m	10	
Max. visina između jedinica (Unutarnji na vrhu)	m	10	
Neto dimenzija Unutarnja (visina/dužina/dubina)	mm	289/845/209	
Neto dimenzija Vanjska (visina/dužina/dubina)	mm	555/732/330	
Neto težina Unutarnja / Vanjska	kg	11/24,5	

GRANICE RADA (vanjska temperatura):

Hlađenje: -15 °C ~ +50 °C

Grijanje: -25°C ~ +30 °C

RASPON POSTAVKI UNUTARNJE TEMPERATURE: 16-30 °C

MODEL		VOKEL ŠIFRA X3I ECO PLUS 52 LH		VOKEL ŠIFRA X3I ECO PLUS 71 LH	
Unutarnja jedinica		1418183 X3I ECO PLUS 52 HL WF LH		1418185 X3I ECO PLUS 71 HL WF LH	
Vanjska jedinica		1418184 X3I ECO PLUS 52 SH LH		1418186 X3I ECO PLUS 71 SH LH	
		Hlađenje	Grijanje	Hlađenje	Grijanje
Kapacitet (nominalni-minimalni-maksimalni) (EN14511)	kW	5,20 (1,00-6,10)	5,60 (1,10-6,60)	7,10 (2,00-8,85)	7,80 (1,80-9,45)
	BTU/h	17800	19100	24200	25300
EER / COP (EN14511)		3,30	3,90	3,50	3,90
Dizajn (Pdesign c / Pdesign h) (prosje/toplo/hladno) (EN14825)	kW	5,2	4,2/4,3/5,0	7,1	5,6/5,7/6,3
Omjer učinkovitosti SEER / SCOP (prosje/toplo/hladno) (EN14825)		7,1	4,2/5,7/3,4	7,0	4,2/5,4/3,4
Energetski razred		A++	A+/A+++/A	A++	A+/A+++/A
Godišnja potrošnja energije C/H (prosje/toplo/hladno)	kWh/annum	256	1400/1056/3088	355	1867/1478/3891
Unutarnji protok zraka	m ³ /h	850-750-680-610-570-520-460		1250-1100-1000-950-900-850-800	
Odvlaživanje	l/h	1,9		2,4	
Brzina ventilatora (unutarnji/vanjski)	n°	7/2		7/2	
Zvučni pritisak - unutarnji	dB(A)	44-43-41-38-36-34-30		48-44-41-40-38-36-33	
Zvučni pritisak - vanjski	dB(A)	56		59	
Snaga zvuka - unutarnji	dB(A)	60-56-54-51-49-47-43		64-59-56-55-53-51-48	
Snaga zvuka - vanjski	dB(A)	65		70	
Napajanje	V/Ph/Hz	220-240V~/1/50		220-240V~/1/50	
Snaga izlazne struje	kW	1,576 (0,10-2,35)	1,436 (0,18-2,40)	2,030 (0,45-2,90)	2,00 (0,35-3,00)
Model kompresora		Rotary DC Inverter		Rotary DC Inverter	
Vrsta rashladnog sredstva		R32/675		R32/675	
Količina rashladnog sredstva	kg/T.CO ₂ eq.	0,82/0,553		1,5/1,0125	
Promjer cijevi za tekućinu	mm (")	6,35 (1/4")		6,35 (1/4")	
Promjer cijevi za plin	mm (")	12,7 (1/2")		15,88 (5/8")	
Max. duljina cijevi sa standardnim nabojem plina	m	3-5		3-5	
Max. duljina cijevi s dodatnim nabojem	m	25		25	
Dodatna napunjenost rashladnog sredstva	g/m	16		40	
Max. visina između jedinica (Vanjski na vrhu)	m	10		10	
Max. visina između jedinica (Unutarnji na vrhu)	m	10		10	
Neto dimenzija Unutarnja (visina/dužina/dubina)	mm	300/970/224		352/1078/246	
Neto dimenzija Vanjska (visina/dužina/dubina)	mm	555/802/350		660/958/402	
Neto težina Unutarnja / Vanjska	kg	13/33		16/46	

GRANICE RADA (vanjska temperatura):

Hlađenje: -15 °C ~ +50 °C

Grijanje: -25°C ~ +30 °C

RASPON POSTAVKI UNUTARNJE TEMPERATURE: 16-30 °C

X3I ECO PLUS PODNA



Infracrveni daljinski upravljač



Žičani upravljač sa tjednim mjeracem vremena

- A ++ Hlađenje
 A + Grijanje (prosječna sezona)
 A +++ Grijanje (toplija sezona)



WIFI

- Možete kontrolirati udobnost svog doma kada i gdje želite.

I FEEL FUNKCIJA

- Senzor unutar daljinskog upravljača osjeća temperaturu u okolini i prenosi signal unutarnjoj jedinici. Na taj način unutarnja jedinica može podesiti volumen i temperaturu protoka zraka kako bi pružila udobnost točno na mjestu gdje je daljinski upravljač postavljen.

SUSTAV ZA PROČIŠĆAVANJE ZRAKA

- Omogućuje učinkovitu sterilizaciju zraka uklanjajući preko 90% bakterija. Uklanja mirise.
- Kvaliteta zraka je poboljšana zahvaljujući emisiji puno negativnih iona kisika.

TANAK I ELEGANTAN DIZAJN

- Konzola se savršeno integrira s bilo kojom vrstom namještaja, zahvaljujući svom čistom, tankom i elegantnom dizajnu.

GRANICA RADA GRIJANJA SMANJENA NA VRLO NISKE VANJSKE TEMPERATURE

- Može raditi u načinu grijanja čak i pri niskim vanjskim temperaturama, do -22°C, stoga je prikladan za oštre klimatske uvjete.

VOKEL ŠIFRA	OPIS	SNAGA GRIJANJA (kW)	SNAGA HLAĐENJA (kW)	ŠIFRA ARTIKLA
1418092	X3I ECO AF27HL PODNA - UNUTARNJA JEDINICA	2,8	2,7	398000669
1418162	X3I ECO PLUS 27 SH LHB - VANJSKA JEDINICA	2,8	2,7	398000740
1418082	X3I ECO PLUS AF35 HL PODNA- UNUTARNJA JEDINICA	3,8	3,52	398000741
1418083	X3I ECO PLUS 35 SH LHB - VANJSKA JEDINICA	3,8	3,52	398000742
1418084	X3I ECO PLUS AF52 HL PODNA- UNUTARNJA JEDINICA	5,33	5,2	398000743
1418085	X3I ECO PLUS 52SH LHB - VANJSKA JEDINICA	5,33	5,2	398000744

MODEL		PODNA X3I ECO AF27HL	
Unutarnja jedinica		VOKEL ŠIFRA 1418092	
Vanjska jedinica		VOKEL ŠIFRA 1418162	
		Hlađenje	Grijanje
Kapacitet (nominalni-minimalni-maksimalni) (EN14511)	kW	2,7 (0,7-3,4)	2,9 (0,6-3,5)
	BTU/h	9200	10000
EER / COP (EN14511)		3,75	3,97
Dizajn (Pdesign c / Pdesign h) (prosje/toplo/hladno) (EN14825)	kW	2,7	2,6/2,8/-
Omjer učinkovitosti SEER / SCOP (prosje/toplo/hladno) (EN14825)		7,20	4,0/5,3/-
Energetski razred		A++	A+/A+++/-
Godišnja potrošnja energije C/H (prosje/toplo/hladno)	kWh/annum	131	910/740
Unutarnji protok zraka	m ³ /h	500-430-410-370-330-280-250	
Odvlaživanje	l/h	0,8	
Brzina ventilatora (unutarnji/vanjski)	n°	7/2	
Zvučni pritisak - unutarnji	dB(A)	39-36-33-31-29-26-23	
Zvučni pritisak - vanjski	dB(A)	49	
Snaga zvuka - unutarnji	dB(A)	50-48-45-44-42-38-34	
Snaga zvuka - vanjski	dB(A)	60	
Napajanje	V/Ph/Hz	220-240~/1/50	
Snaga izlazne struje	kW	0,72 (0,17-1,3)	0,73 (0,13-1,35)
Model kompresora		Rotary DC Inverter	
Vrsta rashladnog sredstva		R32/675	
Količina rashladnog sredstva	kg/T.CO ₂ eq.	0,55/0,37	
Promjer cijevi za tekućinu	mm (")	6,35 (1/4")	
Promjer cijevi za plin	mm (")	9,52 (3/8")	
Max. duljina cijevi sa standardnim nabojem plina	m	3-5	
Max. duljina cijevi s dodatnim nabojem	m	15	
Dodatna napunjenost rashladnog sredstva	g/m	16	
Max. visina između jedinica (Vanjski na vrhu)	m	10	
Max. visina između jedinica (Unutarnji na vrhu)	m	10	
Neto dimenzija Unutarnja (visina/dužina/dubina)	mm	600/700/215	
Neto dimenzija Vanjska (visina/dužina/dubina)	mm	540/782/320	
Neto težina Unutarnja / Vanjska	kg	15,5/27,5	

GRANICE RADA (vanjska temperatura):

Hlađenje: -15 °C ~ +43 °C

Grijanje: -22°C ~ +24 °C

RASPON POSTAVKI UNUTARNJE TEMPERATURE: 16-30 °C

MODEL		VOKEL ŠIFRA X3I ECO PLUS 35		VOKEL ŠIFRA X3I ECO PLUS 52	
Unutarnja jedinica		1418082 X3I ECO PLUS AF35 HL		1418084 X3I ECO PLUS AF52 HL	
Vanjska jedinica		1418083 X3I ECO PLUS 35 SH LHB		1418085 X3I ECO PLUS 52 SH LHB	
		Hlađenje	Grijanje	Hlađenje	Grijanje
Kapacitet (nominalni-minimalni-maksimalni) (EN14511)	kW	3,52 (0,8-4,4)	3,8 (1,1-4,4)	5,2 (1,26-6,6)	5,33 (1,12-6,8)
	BTU/h	12000	13000	17800	18000
EER / COP (EN14511)		3,52	3,96	3,40	3,55
Dizajn (Pdesign c / Pdesign h) (prosje/toplo/hladno) (EN14825)	kW	3,5	3,20/3,30/-	5,2	5,0/5,2/-
Omjer učinkovitosti SEER / SCOP (prosje/toplo/hladno) (EN14825)		7,0	4,10/5,30/-	6,6	4,1/5,1/-
Energetski razred		A++	A+/A+++/-	A++	A+/A+++/-
Godišnja potrošnja energije C/H (prosje/toplo/hladno)	kWh/annum	175	1050/961/2953	260	1707/1427/-
Unutarnji protok zraka	m ³ /h	600-520-480-440-400-360-280		700-650-580-520-460-410-320	
Odvlaživanje	l/h	1,2		1,8	
Brzina ventilatora (unutarnji/vanjski)	n°	7/2		7/2	
Zvučni pritisak - unutarnji	dB(A)	44-40-38-36-33-29-25		47-45-42-40-37-35-31	
Zvučni pritisak - vanjski	dB(A)	52		57	
Snaga zvuka - unutarnji	dB(A)	54-50-48-46-43-39-35		57-55-52-50-47-45-41	
Snaga zvuka - vanjski	dB(A)	62		65	
Napajanje	V/Ph/Hz	220-240~/1/50		220-240~/1/50	
Snaga izlazne struje	kW	1,00 (0,16-1,5)	0,960 (0,165-1,5)	1,55 (0,38-2,45)	1,5 (0,35-2,5)
Model kompresora		Rotary DC Inverter		Rotary DC Inverter	
Vrsta rashladnog sredstva		R32/675		R32/675	
Količina rashladnog sredstva	kg/T.CO ₂ eq.	0,75/0,51		0,95/0,64	
Promjer cijevi za tekućinu	mm (")	6,35 (1/4")		6,35 (1/4")	
Promjer cijevi za plin	mm (")	9,52 (3/8")		12,7 (1/2")	
Max. duljina cijevi sa standardnim nabojem plina	m	3-5		3-5	
Max. duljina cijevi s dodatnim nabojem	m	20		25	
Dodatna napunjenost rashladnog sredstva	g/m	16		20	
Max. visina između jedinica (Vanjski na vrhu)	m	10		10	
Max. visina između jedinica (Unutarnji na vrhu)	m	10		10	
Neto dimenzija Unutarnja (visina/dužina/dubina)	mm	600/700/215		600/700/215	
Neto dimenzija Vanjska (visina/dužina/dubina)	mm	596/848/320		700/965/396	
Neto težina Unutarnja / Vanjska	kg	15,5/30,5		15,5/46	

GRANICE RADA (vanjska temperatura):

Hlađenje: -15 °C ~ +43 °C

Grijanje: -22°C ~ +24 °C

RASPON POSTAVKI UNUTARNJE TEMPERATURE: 16-30 °C

X3MI ECO



NEKOLIKO OPCIJA

- Mogućnost izbora između različitih kapaciteta i tipova unutarnjih jedinica.

ŠIROK RASPON

- Raspon kapaciteta od 18 do 4200 BTU/h
- Široko se koristi u stambenim kućama, hotelima, poslovnim uredima

DC INVERTERSKA TEHNOLOGIJA

- Niska potrošnja
- Niska razina buke
- Precizna kontrola temperature

NISKO AMBIJENTALNO HLAĐENJE I GRIJANJE

- Sposobnost rada do -15 °C vanjske temperature. U načinu hlađenja i grijanja, osigurava visoku pouzdanost proizvoda: kada se vanjska temperatura promijeni, frekvencija kompresora i brzina ventilatora se prilagođavaju u skladu s tim.

VOKEL ŠIFRA	OPIS	SMAGA GRIJANJA (kW)	SNAGA HLAĐENJA (kW)	ŠIFRA ARTIKLA
1418086	DUAL X3MI ECO 52SH - VANJSKA JEDINICA	5,4	5,2	398000792
1418087	TRIAL X3MI ECO 61SH - VANJSKA JEDINICA	6,5	6,1	398000793
1418088	TRIAL X3MI ECO 71SH - VANJSKA JEDINICA	8,5	7,1	398000794
1418089	QUADRI X3MI ECO 80SH - VANJSKA JEDINICA	9,5	8,0	398000795
1418090	QUADRI X3MI ECO 105SH - VANJSKA JEDINICA	11	10,5	398000796
1418091	PENTA X3MI ECO 120SH - VANJSKA JEDINICA	13	12	398000797

MODEL		DUAL X3MI ECO 18 DCI R32		TRIAL X3MI ECO 21 DCI R32	
		VOKEL ŠIFRA 1418086		VOKEL ŠIFRA 1418087	
Vanjska jedinica					
		Hlađenje	Grijanje	Hlađenje	Grijanje
Kapacitet (nominalni-minimalni-maksimalni) (EN14511)	kW	5,30 (2,14-5,80)	5,65 (2,58-6,50)	6,10 (2,20-8,30)	6,50 (3,60-8,50)
	BTU/h	18000	19300	20800	22200
EER / COP (EN14511)		3,58	4,53	4,12	4,56
Dizajn (Pdesign c / Pdesign h) (prosje/toplo/hladno) (EN14825)	kW	5,3	4,3	6,1	6,1
Omjer učinkovitosti SEER / SCOP (prosje/toplo/hladno) (EN14825)		6,6	4,0	6,1	4,0
Energetski razred		A++	A+	A++	A+
Godišnja potrošnja energije C/H (prosje/toplo/hladno)	kWh/annum	281	1505	350	2135
Min./Max. broj spojivih unutarnjih jedinica	br.	2		2-3	
Brzina protoka zraka	m ³ /h	2300		3800	
Brzina ventilatora - vanjski	n°	2		2	
Zvučni pritisak - vanjski	dB(A)	50	54	57	58
Snaga zvuka - vanjski	dB(A)	64		68	
Napajanje	V/Ph/Hz	220-240~/1/50		220-240~/1/50	
Snaga izlazne struje nominalna (min. - max.)	kW	1,48 (0,56-1,56)	1,25 (0,78-1,78)	1,48 (0,95-2,39)	1,43 (0,78-2,87)
Model kompresora		Rotary DC Inverter		Rotary DC Inverter	
Vrsta rashladnog sredstva		R32/675		R32/675	
Količina rashladnog sredstva	kg/T.CO ₂ eq.	0,90/0,608		1,6/1,080	
Promjer cijevi za tekućinu	mm (")	6,35 (1/4")		6,35 (1/4")	
Promjer cijevi za plin	mm (")	9,52 (3/8")		9,52 (3/8")	
Min./Max. duljina cijevi sa standardnim nabojem plina	m	3-10		3-30	
Max. duljina cijevi s dodatnim nabojem	m	40		60	
Max duljina cijevi za jedinicu	m	20		20	
Dodatna napunjenost rashladnog sredstva	g/m	20		20	
Max. visina između jedinica (Unutarnji na vrhu)	m	15		15	
Neto dimenzija Vanjska (visina/dužina/dubina)	mm	550/745/300		654/889/340	
Neto težina	kg	30		47,5	

GRANICE RADA (vanjska temperatura):

Hlađenje: -15 °C ~ +43 °C

Grijanje: -15°C ~ +24 °C

RASPON POSTAVKI UNUTARNJE TEMPERATURE: 16-30 °C

MODEL		TRIAL X3MI ECO 24 DCI R32		QUADRI X3MI ECO 28 DCI R32	
		VOKEL ŠIFRA 1418088		VOKEL ŠIFRA 1418089	
Vanjska jedinica					
		Hlađenje	Grijanje	Hlađenje	Grijanje
Kapacitet (nominalni-minimalni-maksimalni) (EN14511)	kW	7,10 (2,30-9,20)	8,60(3,65-9,20)	8,0 (2,30-11,0)	9,50 (3,65-10,25)
	BTU/h	24200	29300	28000	32400
EER / COP (EN14511)		3,77	3,86	3,77	4,31
Dizajn (Pdesign c / Pdesign h) (prosje/toplo/hladno) (EN14825)	kW	7,1	6,1	8,0	7,2
Omjer učinkovitosti SEER / SCOP (prosje/toplo/hladno) (EN14825)		6,1	4,0	6,1	4,0
Energetski razred		A++	A+	A++	A+
Godišnja potrošnja energije C/H (prosje/toplo/hladno)	kWh/annum	407	2189	459	2520
Min./Max. broj spojivih unutarnjih jedinica	br.	2-3		2-4	
Brzina protoka zraka	m ³ /h	3800		3800	
Brzina ventilatora - vanjski	n°	2		2	
Zvučni pritisak - vanjski	dB(A)	57	58	58	
Snaga zvuka - vanjski	dB(A)	68		68	
Napajanje	V/Ph/Hz	220-240~/1/50		220-240~/1/50	
Snaga izlazne struje nominalna (min. - max.)	kW	1,88 (1,10-2,87)	2,23 (0,98-2,87)	2,12 (1,30-3,58)	2,20 (1,0-2,87)
Model kompresora		Rotary DC Inverter		Rotary DC Inverter	
Vrsta rashladnog sredstva		R32/675		R32/675	
Količina rashladnog sredstva	kg/T.CO ₂ eq.	1,7/1,148		1,8/1,215	
Promjer cijevi za tekućinu	mm (")	6,35 (1/4")		6,35 (1/4")	
Promjer cijevi za plin	mm (")	9,52 (3/8")		9,52 (3/8")	
Min./Max. duljina cijevi sa standardnim nabojem plina	m	3-30		3-40	
Max. duljina cijevi s dodatnim nabojem	m	60		70	
Max duljina cijevi za jedinicu	m	20		20	
Dodatna napunjenost rashladnog sredstva	g/m	20		20	
Max. visina između jedinica (Unutarnji na vrhu)	m	15		15	
Neto dimenzija Vanjska (visina/dužina/dubina)	mm	654/889/340		654/889/340	
Neto težina	kg	47,5		51	

GRANICE RADA (vanjska temperatura):

Hlađenje: -15 °C ~ +43 °C

Grijanje: -15°C ~ +24 °C

RASPON POSTAVKI UNUTARNJE TEMPERATURE: 16-30 °C

MODEL		QUADRI X3MI ECO 36 DCI R32		PENTA X3MI ECO 42 DCI R32	
		VOKEL ŠIFRA 1418090		VOKEL ŠIFRA 1418091	
Vanjska jedinica					
		Hlađenje	Grijanje	Hlađenje	Grijanje
Kapacitet (nominalni-minimalni-maksimalni) (EN14511)	kW	10,60 (2,60-12,00)	12,00 (3,00-14,00)	12,10(2,60-15,20)	13,00 (3,00-15,50)
	BTU/h	36200	40900	41300	44400
EER / COP (EN14511)		3,53	3,95	3,56	4,08
Dizajn (Pdesign c / Pdesign h) (prosje/toplo/hladno) (EN14825)	kW	10,6	10,5	12,10	13,00
Omjer učinkovitosti SEER / SCOP (prosje/toplo/hladno) (EN14825)		7,2	4,0	6,1	4,0
Energetski razred		A++	A+	A++	A+
Godišnja potrošnja energije C/H (prosje/toplo/hladno)	kWh/annum	515	3675	689	4130
Min./Max. broj spojivih unutarnjih jedinica	br.	2-4		2-5	
Brzina protoka zraka	m ³ /h	5800		5800	
Brzina ventilatora - vanjski	n°	2		2	
Zvučni pritisak - vanjski	dB(A)	60		60	
Snaga zvuka - vanjski	dB(A)	70		72	74
Napajanje	V/Ph/Hz	220-240~/1/50		220-240~/1/50	
Snaga izlazne struje nominalna (min. - max.)	kW	3,00	3,04	3,40	3,19
Model kompresora		Rotary DC Inverter		Rotary DC Inverter	
Vrsta rashladnog sredstva		R32/675		R32/675	
Količina rashladnog sredstva	kg/T.CO ₂ eq.	2,40/1,62		2,40/1,62	
Promjer cijevi za tekućinu	mm (")	6,35 (1/4")		6,35 (1/4")	
Promjer cijevi za plin	mm (")	9,52 (3/8")		9,52 (3/8")	
Min./Max. duljina cijevi sa standardnim nabojem plina	m	3-40		3-50	
Max. duljina cijevi s dodatnim nabojem	m	80		100	
Max duljina cijevi za jedinicu	m	25		25	
Dodatna napunjenost rashladnog sredstva	g/m	20		20	
Max. visina između jedinica (Vanjski na vrhu)	m	25		25	
Max. visina između jedinica (Unutarnji na vrhu)	m	15		25	
Neto dimenzija Vanjska (visina/dužina/dubina)	mm	826/1020/427		826/1020/427	
Neto težina	kg	72		73	

GRANICE RADA (vanjska temperatura):

Hlađenje: -15 °C ~ +43 °C

Grijanje: -15°C ~ +24 °C

RASPON POSTAVKI UNUTARNJE TEMPERATURE: 16-30 °C

X3I ECO KAZETNA - za multi sistem

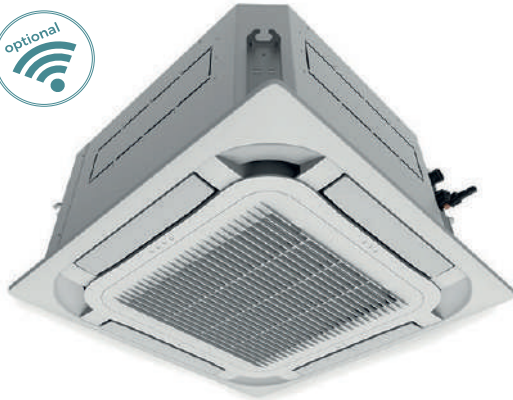

Infracrveni daljinski upravljač



Žičani upravljač s wifijem



Žičani upravljač sa tjednim mjeracem vremena

3 načina mirovanja	Mjerač vremena	Inteligentno odmrzavanje	Auto+ X-fan	Turbo "Turbo" funkcija	Auto dijagnostika	Odvlaživanje	Automatsko ponovno pokretanje	Brzina ventilatora	Zaključavanje za djecu
Samo za multi sistem	-15 °C Min. temp. grijanja	-15 °C Min. temp. i hlađenja	8 °C grijanja	Tiho	Feel	Štedi energiju	Integrirana pumpa za odvod kondenzata	Žičani upravljač (po izboru)	Kontrola vrata (po izboru)

VOKEL ŠIFRA	OPIS	ŠIFRA ARTIKLA
1418155	MASKA KAZETNE JEDINICE	398100688
1418158	MASKA KAZETNE JEDINICE - VELIKA	398100677

MODEL		KAZETNA JEDINICA X3I ECO AS35HL		KAZETNA JEDINICA X3I ECO AS850HL	
		VOKEL ŠIFRA 1418176		VOKEL ŠIFRA 1418177	
Unutarnja jedinica		Hlađenje	Grijanje	Hlađenje	Grijanje
Kapacitet	kW	3,5	4,0	5,0	5,50
Brzina protoka zraka	m³/h	560-540-490-450-420-380-350		650-540-490-450-420-380-350	
Odvlaživanje	l/h	1,8		1,8	
Brzina ventilatora	n°	7+auto		7+auto	
Zvučni pritisak	dB(A)	41-39-36-34-32-30-28		43-39-36-34-32-30-28	
Snaga zvuka	dB(A)	57-55-52-50-48-46-44		59-55-52-50-48-46-44	
Promjer cijevi za tekućinu	mm (inch")	6,35 (1/4")		6,35 (1/4")	
Promjer cijevi za plin	mm (inch")	9,52 (3/8")		12,7 (1/2")	
Neto dimenzija bez panela (visina/dužina/dubina)	mm	265/570/570		265/570/570	
Neto dimenzija panela (visina/dužina/dubina)	mm	312,5/620/620		312,5/620/620	
Neto dimenzija (visina/dužina/dubina)	mm	47,5/620/620		47,5/620/620	
Neto težina bez panela	kg	17		17	
Neto težina panela	kg	3		3	

MODEL		KAZETNA JEDINICA X3I ECO AS28HL		KAZETNA JEDINICA X3I ECO AS70HL	
		Hlađenje	Grijanje	Hlađenje	Grijanje
Kapacitet	kW	2,80	2,90	7,0	8,0
Brzina protoka zraka	m ³ /h	560-540-490-450-420-380-350		1100-1050-950-910-870-830-800	
Odvlaživanje	l/h	1,4		2,5	
Brzina ventilatora	n°	7+auto		7+auto	
Zvučni pritisak	dB(A)	41-39-36-34-32-30-28		46-45-44-43-42-41-39	
Snaga zvuka	dB(A)	57-55-52-50-48-46-44		62-61-60-59-58-57-55	
Promjer cijevi za tekućinu	mm (inch")	6,35 (1/4")		6,35 (1/4")	
Promjer cijevi za plin	mm (inch")	9,52 (3/8")		15,88 (5/8")	
Neto dimenzija bez panela (visina/dužina/dubina)	mm	265/570/570		240/840/840	
Neto dimenzija panela (visina/dužina/dubina)	mm	312,5/620/620		292/950/950	
Neto dimenzija	mm	47,5/620/620		52/950/950	
Neto težina bez panela	kg	17		29	
Neto težina panela	kg	3		6	

Navedeni modeli su dostupni po narudžbi.**

X3I ECO KANALNA- za multi sistem



3 načina spavanja	Mjerač vremena	Inteligentno odmrzavanje	Štedi energiju	"Turbo" funkcija	Aut dijagnostika	Odvlaživanje	Automatsko ponovno pokretanje	Brzina ventilatora	iFeel	Tiho
Samo za multi sistem	Min. temp. grijanja	Min. temp. hlađenja	8°C grijanja	Zičani upravljač (po izboru)	Kontrola vrata (po izboru)	Integrirana puma za odvod kondenzata				

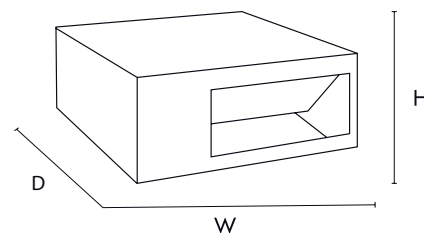

MODEL		KANALNA JEDINICA X3I ECO SD35HL		KANALNA JEDINICA X3I ECO SD50HL	
		VOKEL ŠIFRA 1418148		VOKEL ŠIFRA 1418149	
		Hlađenje	Grijanje	Hlađenje	Grijanje
Kapacitet	kW	3,50	3,85	5,0	5,50
Brzina protoka zraka	m ³ /h	700-670-640-610-580-550-520		880-840-810-790-770-750-730	
Min-max vanjski statični pritisak	Pa	25-60		25-60	
Odvlaživanje	l/h	1,4		1,8	
Brzina ventilatora	n°	7+auto		7+auto	
Zvučni pritisak	dB(A)	41-39-38-37-36-35-34		41-39-39-38-38-37-34	
Snaga zvuka	dB(A)	57-55-54-53-52-51-50		57-55-55-54-54-53-50	
Promjer cijevi za tekućinu	mm (inch")	6,35 (1/4")		6,35 (1/4")	
Promjer cijevi za plin	mm (inch")	9,52 (3/8")		12,7 (1/2")	
Neto dimenzija (visina/dužina/dubina)	mm	200/710/450		200/1010/450	
Neto težina	kg	19		25	

MODEL		KANALNA JEDINICA X3I ECO SD27HL		KANALNA JEDINICA X3I ECO SD70HL	
		Hlađenje	Grijanje	Hlađenje	Grijanje
Kapacitet	kW	2,65	2,80	7,00	8,00
Brzina protoka zraka	m ³ /h	650-560-520-480-450-410-380		1500-1200-1200-1000-1000-900-900	
Min-max vanjski statični pritisak	Pa	25-60		25-125	
Odvlaživanje	l/h	0,8		2,5	
Brzina ventilatora	n°	7+auto		7+auto	
Zvučni pritisak	dB(A)	39-37-36-35-34-33-32		45-40-40-38-38-36-36	
Snaga zvuka	dB(A)	55-53-52-51-50-49-48		62-57-57-55-55-53-53	
Promjer cijevi za tekućinu	mm (inch")	6,35 (1/4")		6,35 (1/4")	
Promjer cijevi za plin	mm (inch")	9,52 (3/8")		15,88 (1/2")	
Neto dimenzija (visina/dužina/dubina)	mm	200/710/450		260/900/655	
Neto težina	kg	18,5		31	

Navedeni modeli su dostupni po narudžbi.**

HEATER KALORIFERI

HEATER toplovodni grijači su jedan u nizu modernih i pouzdanih uređaja proizvedenih da griju zgrade sa velikim kapacitetom



3 BRZINSKI VENTILATOR
kao standardna ponuda

KALORIFER - S TROBRZINSKIM VENTILATOROM CR1, CR2, CR3

- * visina ΔT ispušnog zraka
- * maksimalna upotreba površine izmjenjivača
- * visoka učinkovitost na svakoj brzini

ŠIFRA VOKEL	OPIS	SNAGA	ŠIFRA ARTIKLA
1447021	KAROLIFER CR1	9-30kW	WA0016+WAA0028(konzola)
1447022	KAROLIFER CR2	13-50kW	WA0017+WAA0028(konzola)
1447023	KAROLIFER CR3	20-70kW	WA0018+WAA0028(konzola)

INSTALACIJA UREĐAJA

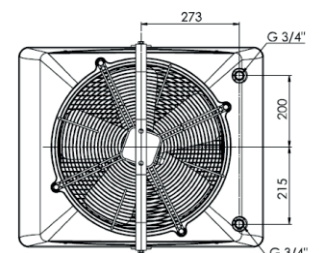
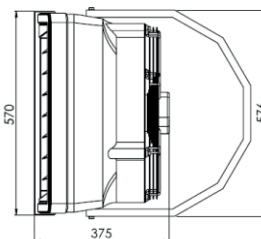
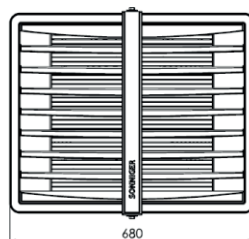
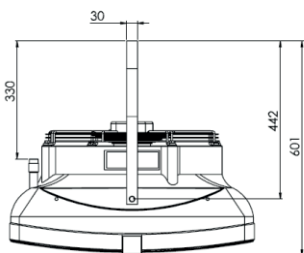
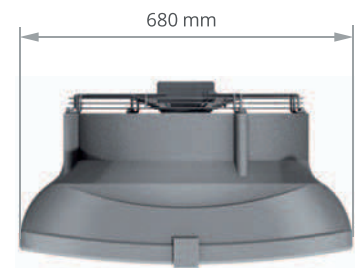
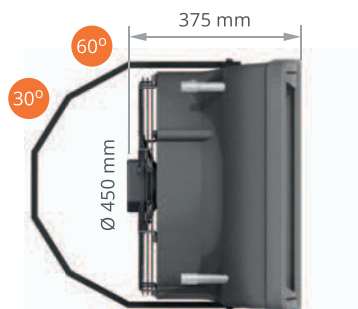
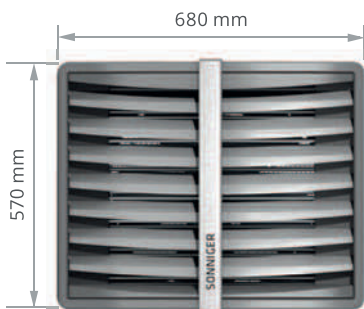
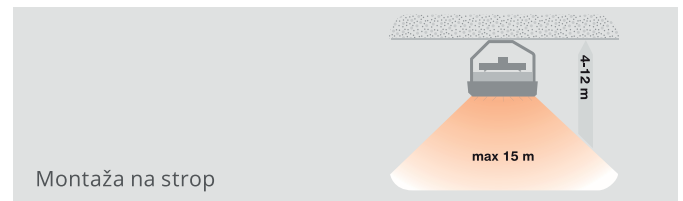
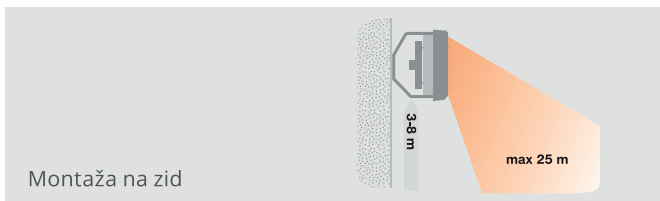

HEATER CONDENS series

TEHNIČKI PODACI		CR ONE	CR1	CR2	CR3	CR3 MAX	CR4 MAX	MIX 1
raspon toplinske snage *	kW	7-20	9-30	13-50	20-70	33-90	45-120	-
izlaz topline (70/50°C)/ΔT porast temperature zraka **	kW/°C	13/25	16/14	26/22	35/34	53/28	72/42	-
broj jedinica		2	1	2	3	3	4	-
izlaz zraka - III brzina	m ³ /h	1600	3900	3350	2950	5250	4650	4800
nivo zvuka na 5m udaljenosti - III brzina	dB	52	62	60	58	65	65	54
promjer priključnih mlaznica	inches	1/2"	3/4"	3/4"	3/4"	1"	1"	-
parametri napajanja V/Hz 230/50	W/A	124/0,58	240/1,08		520/2,2		240/1,08	

* maksimalan izlaz topline naznačen za temperaturu vodenog sredstva 120/90°C i temperaturu ulaza zraka 0°C, III brzina/minimalan izlaz topline naznačen za 50/30°C i temperatura ulaza zraka 0°C, III brzina
 ** za temperaturu ulaza zraka 0°C

HEATER CONDENS CR1

ulaz/izlaz temperature vode temperatura ulaznog zraka	50/30				50/40				60/40				70/50				80/60				90/70				120/90									
	0	5	10	15	20	0	5	10	15	20	0	5	10	15	20	0	5	10	15	20	0	5	10	15	20	0	5	10	15	20	0	5	10	15
protok zraka 3900 m ³ /h (brzina 3)																																		
izlaz topline	kW																																	
temperatura	°C																																	
protok vode	m ³ /h																																	
pad tlaka	kPa																																	
protok zraka 2500 m ³ /h (brzina 2)																																		
izlaz topline	kW																																	
temperatura	°C																																	
protok vode	m ³ /h																																	
pad tlaka	kPa																																	
protok zraka 1850 m ³ /h (brzina 1)																																		
izlaz topline	kW																																	
temperatura	°C																																	
protok vode	m ³ /h																																	
pad tlaka	kPa																																	

HEATER CONDENS CR2

ulaz/izlaz temperature vode temperatura ulaznog zraka	50/30				50/40				60/40				70/50				80/60				90/70				120/90						
	0	5	10	15	20	0	5	10	15	20	0	5	10	15	20	0	5	10	15	20	0	5	10	15	20	0	5	10	15	20	
protok zraka 3350 m ³ /h (brzina 3)																															
izlaz topline	kW																														
temperatura	°C																														
protok vode	m ³ /h																														
pad tlaka	kPa																														
protok zraka 2000 m ³ /h (brzina 2)																															
izlaz topline	kW																														
temperatura	°C																														
protok vode	m ³ /h																														
pad tlaka	kPa																														
protok zraka 1450 m ³ /h (brzina 1)																															
izlaz topline	kW																														
temperatura	°C																														
protok vode	m ³ /h																														
pad tlaka	kPa																														

HEATER CONDENS CR3

ulaz/izlaz temperature vode temperatura ulaznog zraka	50/30				50/40				60/40				70/50				80/60				90/70				120/90						
	0	5	10	15	20	0	5	10	15	20	0	5	10	15	20	0	5	10	15	20	0	5	10	15	20	0	5	10	15	20	
protok zraka 2950 m ³ /h (brzina 3)																															
izlaz topline	kW																														
temperatura	°C																														
protok vode	m ³ /h																														
pad tlaka	kPa																														
protok zraka 1700 m ³ /h (brzina 2)																															
izlaz topline	kW																														
temperatura	°C																														
protok vode	m ³ /h																														
pad tlaka	kPa																														
protok zraka 1200 m ³ /h (brzina 1)																															
izlaz topline	kW																														
temperatura	°C																														
protok vode	m ³ /h																														
pad tlaka	kPa																														

GUARD ZRAČNA ZAVJESA

Novi GUARD dolazi sa modernim dizajnom, visokim performansama i punim rasponom opreme. GARD je sinonim za modernu, superiornu i naprednu tehnologiju.



PREDNOSTI

- Moderan dizajn
- Visoke performanse, protok zraka 4800 m³/h, domet zraka do 4 m
- Tehnologija PTC električnih grijača
- Nivo niske buke, reducirana težina

ZRAČNA ZAVJESA

GUARD

- * moderan dizajn
- * bacanje zraka do 4 m
- * dužina 100, 150, 200 cm
- * CGA0051 - SET DRŽAČA
- * kontrola brzine
- * vodeni, električni i zračni izmjenjivač
- * PFC tehnologija električnog grijača

ŠIFRA VOKEL	OPIS	SNAGA	ŠIFRA ARTIKLA
1447009	GUARD 150W	20-29 kW	CG0020+CGA0051
1447010	GUARD 200W	25-40 kW	CG0021+CGA0051
1447011	GUARD 200E	8,5-14 kW	CG0024+CGA0051
1447013	GUARD 100W	10-16kW	CG0019+CGA0051

OPSEG HORIZONTALNOG PROTOKA ZRAKA

(maksimalna visina instalacije)

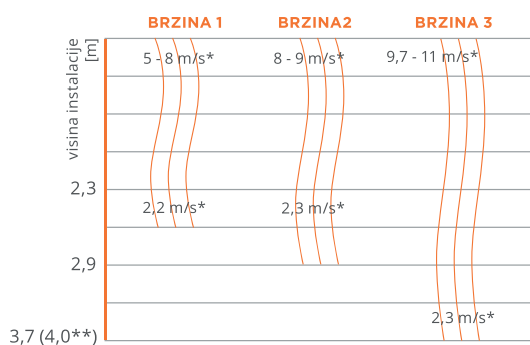

OPSEG VERTIKALNOG PROTOKA ZRAKA

(maksimalni opseg kod vertikalne instalacije)

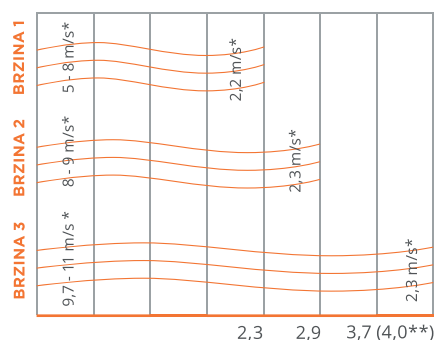

* brzina protoka zraka
** ambijentalna zračna zavjesa

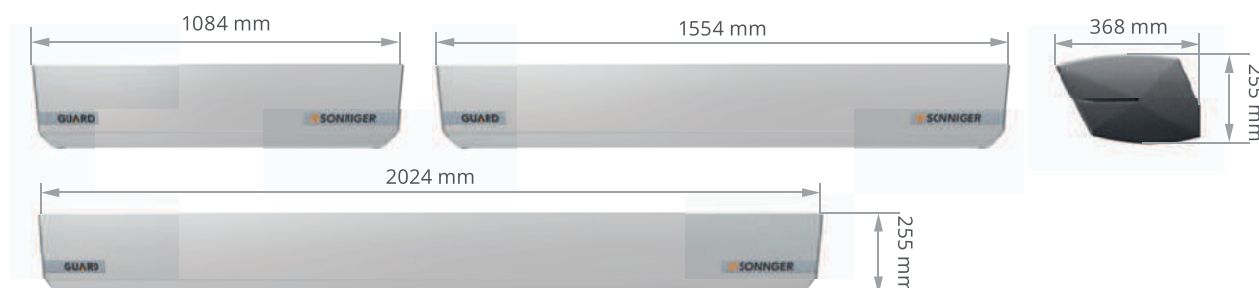

TEHNIČKI PODACI		ZRAČNA ZAVJESA S GRIJAČEM VODE			ZRAČNA ZAVJESA S ELEKTRIČNIM GRIJAČEM			ZRAČNA ZAVJESA BEZ GRIJANJA		
		GUARD 100W	GUARD 150W	GUARD 200W	GUARD 100E	GUARD 150E	GUARD 200E	GUARD 100C	GUARD 150C	GUARD 200C
duljina jedinice	m	1	1.5	2	1	1.5	2	1	1.5	2
maksimalna visina ugradnje	m	4	4	4	4	4	4	4	4	4
maksimalni protok zraka	m ³ /h	2000	3600	4800	2000	3600	4800	2100	3700	5000
opseg toplinskog učina*	kW	10-16	20-29	25-40	4 - 7	6,5 - 11	8,5 - 14	-	-	-
maksimalni radni tlak	MPa	1,6	1,6	1,6	-	-	-	-	-	-
promjer spojnih cijevi	cola	1/2"	1/2"	1/2"	-	-	-	-	-	-
napajanje	V/Hz A	230/50 1,95	230/50 2,6	230/50 2,6	230/50 1,95	230/50 2,6	230/50 2,6	230/50 1,95	230/50 2,6	230/50 2,6
snaga motora	W	220	320	320	220	320	320	220	320	320
potrošnja energije	V/Hz A	-	-	-	400/50 11	400/50 16,6	400/50 22,4	-	-	-
masa	kg	16,5	20,5	28	17	21,5	29	15	18,5	25
nivo zvuka	dB (A)	59	61	62	59	61	62	60	61	62
zaštita class IP	-	IP21	IP21	IP21	IP21	IP21	IP21	IP21	IP21	IP21

* izlazna toplina za vodu 90/70°C i temperatura ulaznog zraka +10°C

GUARD 100W

ZRAČNE ZAVJESE protok zraka - 2000 m³/h

ulaz/izlaz temperatura vode		voda 60/40 °C					voda 70/50 °C					voda 90/70 °C				
ulazna temperatura zraka	°C	0	5	10	15	20	0	5	10	15	20	0	5	10	15	20
izlazna toplina	kW	9	7,9	6,9	5,8	4,8	11,3	10,3	9,2	8,1	7,1	16	14,9	13,9	12,8	11,7
izlazna temperature vode	°C	14,9	18,3	21,8	25,2	28,7	18,4	21,8	25,2	28,7	32,1	25,4	28,8	32,2	35,6	39
protok vode	m ³ /h	0,4	0,3	0,3	0,2	0,2	0,5	0,4	0,4	0,3	0,3	0,7	0,6	0,6	0,5	0,5
pad tlaka	kPa	2	2	1	1	1	4	3	2	2	1	7	6	5	5	4

GUARD 150W

ZRAČNE ZAVJESE protok zraka - 3600 m³/h

ulaz/izlaz temperatura vode		voda 60/40 °C					voda 70/50 °C					voda 90/70 °C				
ulazna temperatura zraka	°C	0	5	10	15	20	0	5	10	15	20	0	5	10	15	20
izlazna toplina	kW	17,4	15,6	13,8	12,1	10,3	21,3	19,5	17,7	15,9	14,1	29,0	27,2	25,4	23,6	21,8
izlazna temperature vode	°C	15,1	18,6	22,1	25,7	29,2	18,3	21,8	25,3	28,9	32,4	24,7	28,2	31,7	35,2	38,7
protok vode	m ³ /h	0,6	0,6	0,5	0,4	0,3	0,8	0,7	0,7	0,6	0,5	1,2	1,1	1	0,9	0,8
pad tlaka	kPa	8	6	4	3	2	12	10	8	6	5	22	19	17	14	12

GUARD 200W

ZRAČNE ZAVJESE protok zraka - 4800 m³/h

ulaz/izlaz temperatura vode		voda 60/40 °C					voda 70/50 °C					voda 90/70 °C				
ulazna temperatura zraka	°C	0	5	10	15	20	0	5	10	15	20	0	5	10	15	20
izlazna toplina	kW	24,7	22,3	19,9	17,5	15,1	29,8	27,4	25,0	22,6	20,2	40,0	37,6	35,2	32,8	30,4
izlazna temperature vode	°C	15,7	19,2	22,7	26,2	29,7	18,9	22,4	25,9	29,4	32,9	25,2	28,7	32,2	35,7	39,2
protok vode	m ³ /h	0,9	0,8	0,7	0,6	0,5	1,1	1	0,9	0,8	0,7	1,6	1,5	1,4	1,3	1,2
pad tlaka	kPa	15	12	9	7	5	22	19	15	12	9	42	37	32	27	23

GUARD 100E, 150E, 200E

ZRAČNE ZAVJESE

		GUARD 100E					GUARD 150E					GUARD 200E				
ulazna temperatura zraka	°C	0	5	10	15	20	0	5	10	15	20	0	5	10	15	20
izlazna toplina	kW	7	7	7	7	7	11	11	11	11	11	14	14	14	14	14
izlazna temperature	°C	12	17	22	27	32	13	18	23	28	33	14	19	24	29	34



PANEL COMFORT TR-110L
REGULACIJA BRZINE I TERMOSTATA

ŠIFRA VOKEL	OPIS	ŠIFRA ARTIKLA
1447012	PANEL COMFORT	WAA0054



TR-010
SOBNI TERMOSTAT

ŠIFRA VOKEL	OPIS	ŠIFRA ARTIKLA
1447005	SOBNI TERMOSTAT	WAA0029



ARW 1.3/E
REGULATOR BRZINE

ŠIFRA VOKEL	OPIS	ŠIFRA ARTIKLA
1447006	REGULATOR BRZINE VRTNJE IP54 230-160 110 V	WAA0033



YWF4E-450B
VENTILATOR ZA KALORIFER

ŠIFRA VOKEL	OPIS	ŠIFRA ARTIKLA
1447018	VENTILATOR ZA KALORIFER YWF4E-450B	WAA0053



ARW 1.3/1
REGULATOR BRZINE

ŠIFRA VOKEL	OPIS	ŠIFRA ARTIKLA
1447007	REGULATOR BRZINE VRTNJE IP54 230-160 110 V	WAA0034



PANEL
ZA AUTOMATSKI REGULATOR BRZINE

ŠIFRA VOKEL	OPIS	ŠIFRA ARTIKLA
1447008	PANEL ZA AUT.REG.BRZINE PSH3 HC RS485	WAA0035



MULTI 6
RAZDJELNIK

ŠIFRA VOKEL	OPIS	ŠIFRA ARTIKLA
1447015	RAZDJELNIK MULTI 6(ZA GUARD I HEATER)	WAA0055

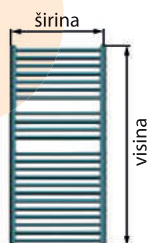

KUPAONSKI RADIJATOR BIJELI

VOKEL ŠIFRA	ŠIRINA (mm)	VISINA (mm)	SNAGA (W)	TLAK (bar)	ŠIFRA ARTIKLA
1467001	450	800	275	10	DGS450800-WF
1467002	500	800	296	10	DGS500800-WF
1467003	550	800	325	10	DGS550800-WF
1467004	600	800	356	10	DGS600800-WF
1467005	450	1200	393	10	DGS4501200-WF
1467006	500	1200	430	10	DGS5001200-WF
1467007	550	1200	473	10	DGS5501200-WF
1467008	600	1200	516	10	DGS6001200-WF
1467009	450	1500	511	10	DGS4501500-WF
1467010	500	1500	538	10	DGS5001500-WF
1467011	550	1500	592	10	DGS5501500-WF
1467012	600	1500	645	10	DGS6001500-WF

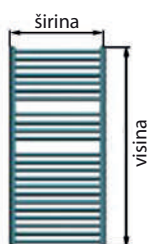
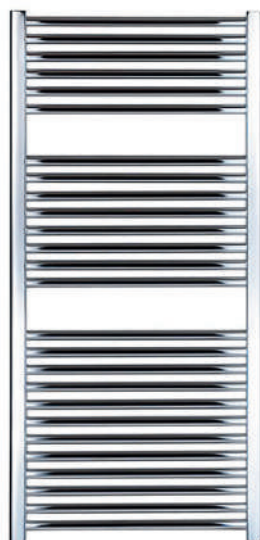

KUPAONSKI RADIJATOR KROMIRANI

VOKEL ŠIFRA	ŠIRINA (mm)	VISINA (mm)	SNAGA (W)	TLAK (bar)	ŠIFRA ARTIKLA
1467013	450	800	234	10	DGS450800-CF
1467014	500	800	253	10	DGS500800-CF
1467015	550	800	278	10	DGS550800-CF
1467016	600	800	303	10	DGS600800-CF
1467017	450	1200	335	10	DGS4501200-CF
1467018	500	1200	365	10	DGS5001200-CF
1467019	550	1200	401	10	DGS5501200-CF
1467020	600	1200	437	10	DGS6001200-CF
1467021	450	1500	435	10	DGS4501500-CF
1467022	500	1500	457	10	DGS5001500-CF
1467023	550	1500	502	10	DGS5501500-CF
1467024	600	1500	547	10	DGS6001500-CF

AF - CN



Hibridni radijatori  

BIJELI



CRNI



KROM



KARAKTERISTIKE

- U skladu sa standardom EN442
- Pametni sustav kontrole temperature obećava sigurnost
- Podržava prilagodbu snage, veličine, završne obrade i boje
- Mogućnost grijanja na struju ili priključivanja na centralno grijanje



Higijenski



Otporan na vlagu



Moderan dizajn

Materijal: čelik

Površinska temperatura: $55^{\circ}\text{C} \pm 3^{\circ}\text{C}$

Završna obrada: kromiranje / praškasti premaz



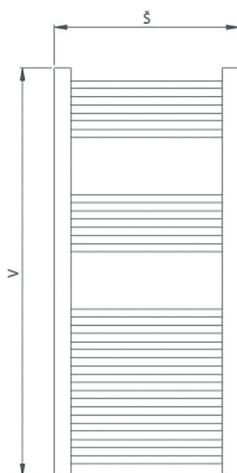

ŠIFRA VOKEL	BOJA	DIMENZIJE (mm)	BROJ CIJEVI	SNAGA (W)	ŠIFRA ARTIKLA
1469001	BIJELA	450x700	13	238	AF-CNW07045
1469002	BIJELA	450x1150	21	386	AF-CNW11545
1469003	BIJELA	450x1500	29	522	AF-CNW15045
1469004	BIJELA	450x1800	39	675	AF-CNW18045
1469005	BIJELA	500x700	13	258	AF-CNW07050
1469006	BIJELA	500x1150	21	419	AF-CNW11550
1469007	BIJELA	500x1500	29	567	AF-CNW15050
1469008	BIJELA	500x1800	39	734	AF-CNW18050
1469009	BIJELA	600x700	13	298	AF-CNW07060
1469010	BIJELA	600x1150	21	483	AF-CNW11560
1469011	BIJELA	600x1500	29	656	AF-CNW16060
1469012	BIJELA	600x1800	39	854	AF-CNW18060

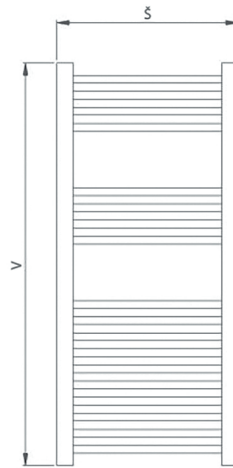

ŠIFRA VOKEL	BOJA	DIMENZIJE (mm)	BROJ CIJEVI	SNAGA (W)	ŠIFRA ARTIKLA
1469021	KROM	450x700	13	188	AF-CNC07045 CHROME
1469022	KROM	450x1150	21	305	AF-CNC11545 CHROME
1469023	KROM	450x1500	29	413	AF-CNC15045 CHROME
1469024	KROM	450x1800	39	533	AF-CNC18045 CHROME
1469013	KROM	500x700	13	204	AF-CNC07050
1469014	KROM	500x1150	21	331	AF-CNC11550
1469015	KROM	500x1500	29	448	AF-CNC15050
1469016	KROM	500x1800	39	580	AF-CNC18050
1469025	KROM	600x700	13	235	AF-CNC07060 CHROME
1469026	KROM	600x1150	21	382	AF-CNC11560 CHROME
1469027	KROM	600x1500	29	518	AF-CNC16060 CHROME
1469028	KROM	600x1800	39	675	AF-CNC18060 CHROME

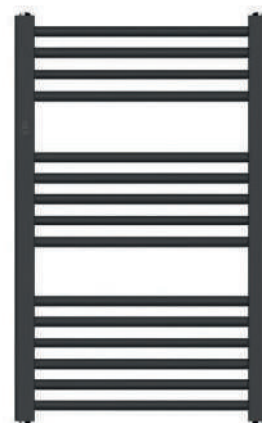
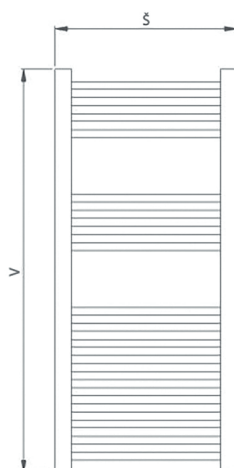

ŠIFRA VOKEL	BOJA	DIMENZIJE (mm)	BROJ CIJEVI	SNAGA (W)	ŠIFRA ARTIKLA
1469029	CRNA	450x700	13	238	AF-CNB07045 MAT BLACK
1469030	CRNA	450x1150	21	386	AF-CNB11545 MAT BLACK
1469031	CRNA	450x1500	29	522	AF-CNB15045 MAT BLACK
1469032	CRNA	450x1800	39	675	AF-CNB18045 MAT BLACK
1469017	CRNA	500x700	13	258	AF-CNB07050
1469018	CRNA	500x1150	21	419	AF-CNB11550
1469019	CRNA	500x1500	29	567	AF-CNB15050
1469020	CRNA	500x1800	39	734	AF-CNB18050
1469033	CRNA	600x700	13	298	AF-CNB07060 MAT BLACK
1469034	CRNA	600x1150	21	483	AF-CNB11560 MAT BLACK
1469035	CRNA	600x1500	29	656	AF-CNB16060 MAT BLACK
1469036	CRNA	600x1800	39	854	AF-CNB18060 MAT BLACK

Nosači

ŠIFRA VOKEL	OPIS	ŠIFRA ARTIKLA
1469037	NOSAČ ZA KUPAONSKI RADIJATOR - BIJELI	AF-BKW01
1469038	NOSAČ ZA KUPAONSKI RADIJATOR - KROM	AF-BKC01
1469039	NOSAČ ZA KUPAONSKI RADIJATOR - CRNI	AF-BKB01



UPUTSTVA ZA UGRADNJU:

Radijator mora biti pričvršćen najmanje 21 cm iznad tla (mjereno od najniže točke radijatora ili grijača ako imate električni cijevni radijator). Nosači moraju biti pričvršćeni na zid od opeke ili betona kako bi se osigurala sigurna ugradnja i kasnija upotreba. Instalacija se mora obaviti u skladu s propisima koji se odnose na električne (u slučaju električnih radijatora) i vodovodne / centralne instalacije.

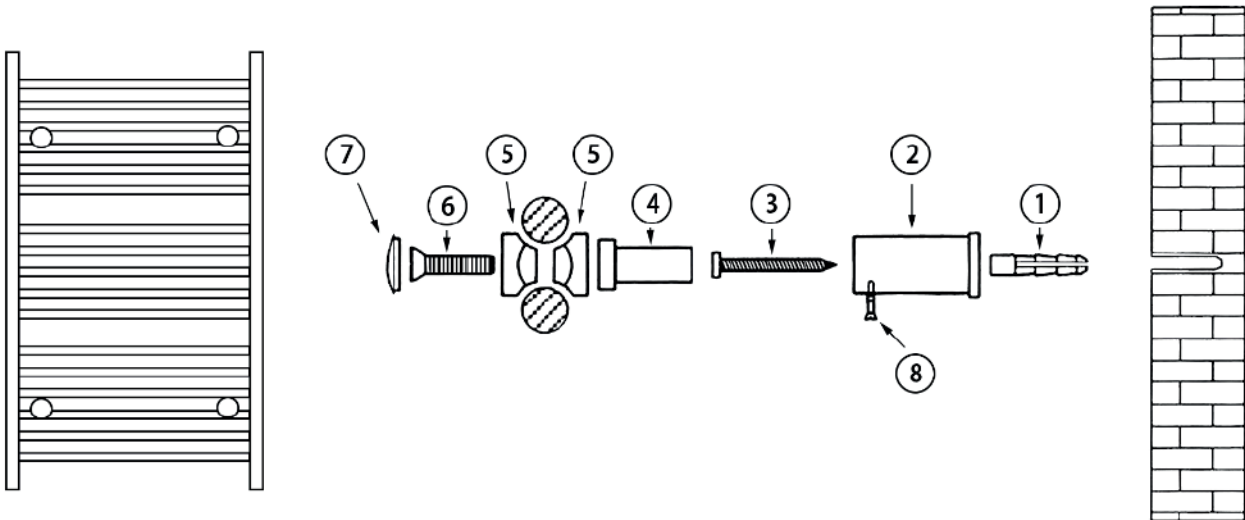

DODATNE UPUTE ZA ELEKTRIČNI RADIJATOR:

Radijator u koji ste ugradili grijač mora biti okomito pričvršćen na zid. (Grijač mora biti ispod, lijevo ili desno). Napunite radijator vodom do polovine gornje cijevi (ili 90% zapremine). Možete dodati 5-10% antifrizu u vodu, ovisno o opasnosti od niskih sobnih temperatura.

ČIŠĆENJE RADIJATORA:

Čistiti samo čistom vodom i tekućim sredstvima za čišćenje. Nikada nemojte koristiti abrazivna i / ili kemijska sredstva za čišćenje.

UDALJENOST RADIJATORA OD WC-a:

Radijatori nisu otporni na mokraćnu kiselinu pa preporučujemo da radijator bude udaljen najmanje 1 m od WC-a. Time se izbjegava hrđanje radijatora prebrzo, što nije posljedica neodgovarajuće kvalitete.

UPOZORENJE:

Proizvod nije igračka. Sprječite djecu da se penju na proizvod jer to može ugroziti sigurnost djece i oštetiti proizvod. Ne koristite radijator za druge svrhe osim za grijanje i sušenje ručnika.

JAMSTVO:

5 godina jamstva na obojene proizvode (praškasti premaz), 3 godine jamstva na proizvode s kromiranom i zlatnom površinom (pocinčavanje), 2 godine na električne grijače za cijevne radijatore.

PROIZVOĐAČ NE PREUZIMA ODGOVORNOST:

Zbog oštećenja u slučaju nepoštivanja uputa za ugradnju, transportnog oštećenja proizvoda od trgovine do kupca, oštećenja uslijed mraza, oštećenja zbog nepravilne upotrebe proizvoda, oštećenja uslijed izlivanja, druga oštećenja.

U slučaju reklamacija kontaktirajte trgovca kod kojeg ste kupili proizvod na način da:

- pošaljete kopiju računa (ne možete podnijeti žalbu bez računa)
- pošaljete sliku lokacije proizvoda u kupaonici i sliku razloga žalbe (npr. puštanje)
- opišete žalbu

U slučaju opravdane reklamacije imate pravo na novi proizvod (potrebno je vratiti stari proizvod). Ostale troškove (npr. isporuka, isporuka novog proizvoda, troškovi zamjene...) snosi kupac.

Želimo Vam zadovoljstvo pri korištenju proizvoda.



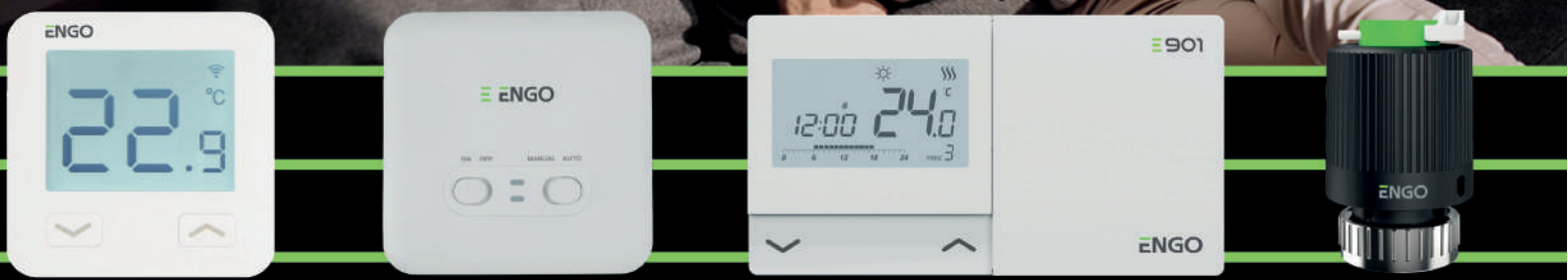

ENERGY CONTROL IN YOUR HOME

E10W230WIFI / E10B230WIFI

Digitalni Internet žičani termostat

E10 je žičani temperaturni termostat s WiFi i Bluetooth modulom. Omogućuje ekonomičnu i ekološku kontrolu bilo koje vrsta grijanja. Omogućuje daljinsko upravljanje sustavom grijanja pomoću ENGO Smart / Tuya Smart aplikacije.

Programiranje E10 je vrlo jednostavno i omogućuje vam da prilagodite ciklus grijanja vašem dnevnom ritmu.

Karakteristike proizvoda:

- minimalistički dizajn
- mogućnost djeljenja uređaja s više korisnika
- grafikoni povijesti temperature dostupni u aplikaciji
- mogućnost postavljanja min. i max. zadane temperature
- push obavijest iz aplikacije
- podesiva jačina pozadinskog osvjetljenja zaslona
- mogućnost spajanja dodatnog NTC senzora
- mnoštvo funkcija dostupnih iz aplikacije ENGO Smart/Tuya Smart
- vrlo jednostavno korištenje

Napajanje	230V AC 50Hz
Maksimalno opterećenje	3 (1) A
Raspon regulacije temperature	5 - 45°C
Točnost prikaza temperature	0.1°C
Upravljački algoritam	TPI ili histereza (±0.1°C ili ±0.5°C)
Komunikacija	WiFi 2,4 GHz
Ulaz S1 - S2	Temperatura poda ili mjerenje temperature zraka
Upravljački izlaz	NO/COM (bez napona)
Klasa zaštite	IP30
Dimenzije [mm]	86 x 86 x 39 (14 nakon ugradnje u kutiju, promjer 60)



ŠIFRA VOKEL	BOJA	ŠIFRA ARTIKLA	PAKIRANJE
1495001	BIJELO	E10W230WIFI	1
1495002	CRNO	E10B230WIFI	1

EASY230 / EASYBAT

Sobni žičani termostat za grijanje i hlađenje

Žičani, dnevni regulator temperature, na napajanje ili baterije (2xAAA). Služi za žičano upravljanje grijačim ili rashladnim uređajima i sustavima. Njegova funkcija je održavanje ugodnih uvjeta u prostoriji u skladu s temperaturom koju je korisnik postavio. Spaja se neposredno na izvor topline ili upravljačku traku. Za bolje pristajanje, model je dostupan u dvije boje. Siguran, pouzdan, jednostavan za korištenje.

Napajanje	230W
Napajanje baterijsko	2xAAA baterije
Maksimalno opterećenje	3 (1) A
Temperaturni raspon	5 - 35°C
Preciznost mjerenja	0.1°C
Upravljački algoritam	TPI ili histereza (±0.2°C - ±0.2°C)
Komunikacija	Žičana
Upravljački izlaz	NO/COM (bez napona)
Klasa zaštite	IP30
Dimenzije [mm]	80 x 80 x 22



ŠIFRA VOKEL	BOJA	ŠIFRA ARTIKLA	PAKIRANJE
1495005	BIJELO	EASY230W	1
1495006	CRNO	EASY230B	1

Sobni žičani termostat sa baterijskim napajanjem

ŠIFRA VOKEL	BOJA	ŠIFRA ARTIKLA	PAKIRANJE
1495008	BIJELO	EASYBATW	1
1495007	CRNO	EASYBATB	1

E901WIFI

Internet bežični termostat, Wifi

E901WIFI je bežični Wi-Fi termostat koji omogućuje ekonomičnu i ekološku kontrolu bilo koje vrste grijanja. Odlikuje se preglednim izbornikom i mnoštvom korisnih funkcije. Rukovanje termostatom je vrlo jednostavno i omogućuje korisniku da prilagodi ciklus grijanja dnevnom ritmu korisnika.

Ugrađeni Wi-Fi modul omogućuje daljinsko upravljanje sustavom grijanja pametnim telefonom ili tabletom pomoću aplikacije ENG Smart / TUYA Smart

Karakteristike proizvoda:

- mogućnost odabira histereze ili ugrađenog TPI algoritma
- programabilna promjena tipa releja
- blokada PIN-om
- mnoštvo funkcija dostupnih iz aplikacije ENGO Smart/Tuya Smart
- ograničavanje maksimalne i minimalne temperature
- funkcija Grijanje / Hlađenje
- ima jedinstvene kodove prijenesa
- automatski obnavlja radni signal



Napajanje	2XAA alkalne baterije
Napajanje prijemnika	230V AC 50Hz
Maksimalno opterećenje prijemnika	16 (5) A
Izlazni signal prijemnika	NO/COM relej bez napona
Raspon kontrole temperature	5° - 35°C
Prikaz točnosti temperature	0,5°C
Kontrolni algoritam	TPI ili Histereza (+/-0,25°C ili +/- 0,5°C)
Komunikacija	Bežični, 868 MHz i WiFi 2.4GHz
Dimenzije [mm]	odašiljač: 150 x 84 x 22 prijemnik: 96 x 96 x 27

ŠIFRA VOKEL	BOJA	ŠIFRA ARTIKLA	PAKIRANJE
1495011	BIJELO	E901WIFI	1

E901RF

Programabilni bežični termostat

E901RF je nadgradni, tjedni sobni regulator, koji se koristi za bežično upravljanje uređajima i sustava grijanja (npr. plinski ili uljni kotlovi, toplinske pumpe) ili hlađenja. Ima funkciju kreiranja vlastitih rasporeda. Zahvaljujući ugrađenim algoritmima, nudi mnogo bolju točnost kontrole temperature od tradicionalnog mehaničkog termostata. E901RF Regulator je tvornički uparen s prijemnikom.

Ugrađeni Wi-Fi modul omogućuje daljinsko upravljanje sustavom grijanja pametnim telefonom ili tabletom pomoću aplikacije ENG Smart / TUYA Smart

Karakteristike proizvoda:

- dvije vrste vremenskih rasporeda
- ograničenje maksimalne/minimalne temperature
- funkcija Grijanje/Hlađenje
- značajka zaključavanja tipki
- jedinstveni kodovi za prijenos
- automatsko ponavljanje signala
- može se odabrati histereza ili ugrađeni TPI algoritam
- softverska promjena tipa releja - (NO) pod naponom otvoren ili (NC) pod naponom zatvoren
- PIN zaključavanje
- za upravljanje podnim ili izvorom grijanja
- radni domet do 100m na otvorenom prostoru



Napajanje	2 x AA alkalne baterije
Napajanje prijemnika	230V AC 50Hz
Maksimalno opterećenje	16 (5) A
Izlazni signal	NO/COM relej bez napona
Raspon regulacije temperature	5 – 35°C
Prikaz točnosti temperature	0,1°C ili 0,5°C
Upravljački algoritam	TPI ili histereza (± 0,25°C ili ± 0,5°C)
Komunikacija	Bežična, 868 MHz
Dimenzije [mm]	odašiljač: 150 x 84 x 22 prijemnik: 96 x 96 x 27

ŠIFRA VOKEL	BOJA	ŠIFRA ARTIKLA	PAKIRANJE
1495010	BIJELO	E901RF	1

Upravljačka letva za 8 zona podnog grijanja

Upravljačka traka ECB08M230 glavni je element upravljačkog sustava podnog grijanja. Ima ugrađene module koji kontroliraju izvore topline (beznaponski relej) i pumpe (230V AC). Upravljačka kutija omogućuje upravljanje 8 različitih zona. Opremljena je 230V AC izlaznim naponom za aktuator. Utični blokovi terminala omogućuju brzo i praktično povezivanje ožičenja. Upravljačka kutija je dizajnirana za rad s NC (normalno zatvorenim) aktuatorima/pogonima.

Karakteristike proizvoda:

- kontrola 8 neovisnih zona grijanja
- naponski izlaz za upravljanje cirkulacijske pumpe
- lagano kućište/lagano kućište
- ugrađeni upravljački modul izvora topline (beznaponski kontakt)
- praktični terminali koji se mogu ukloniti za jednostavno spajanje žica
- 2 namijenjena izlaza aktuatora za svaku od 8 zona
- prilagođena za montažu na DIN šinu
- dizajnirana za ožičene termostate
- ugrađena funkcija odgode uključivanja pumpe i kotla - 3 min.



Napajanje	230V AC 50Hz
Maksimalno opterećenje	6 (1) A Pumpa (230V)
Izlazi	Kotao (NO/COM/NC) Termoelektrični aktuatori (230V)
Dimenzije [mm]	330 x 110 x 36

ŠIFRA VOKEL	BOJA	ŠIFRA ARTIKLA	PAKIRANJE
1495003	CRNO	ECB08M230	1

E30NC230 / E28NC230

Motorni pogon za ventile

Termoelektrični aktuator je namijenjen za korištenje sa sustavima podnog grijanja. Može se koristiti s termostatskim ventilima u 980 - 990 razdjelniku za podno grijanje ili sa zonskim ventilima. Omogućuje otvaranje ili zatvaranje protoka medija za grijanje u petlji, što vam daje kontrolu nad sobnom temperaturom. Suraduje izravno s termostatom ili neizravno preko upravljačke trake.

Karakteristike proizvoda:

- funkcija "First Open" - olakšava prvu instalaciju
- niska potrošnja energije
- male dimenzije
- velik raspon
- brzo vrijeme otvaranja
- moderan dizajn, visoka izdržljivost

Verzija	NC = Normalno zatvoren
Dimenzija navoja	M30 x 1.5 mm, M28 x 1.5mm
Napajanje	230V AC 50Hz
Potrošnja energije	2W
Struja pokretanja	300mA / 200ms
Snaga pritiska	100N +/- 15%
Max. raspon	4,5 mm
Temp. skladištenja	-25°C do 60°C
Temp. okoline	max. 60°C
Klasa zaštite	IP 54 / II
Debljina kabela	90 cm
Dimenzije [mm]	Ø 41 x 65



ŠIFRA VOKEL	BOJA	ŠIFRA ARTIKLA	PAKIRANJE
1495004	CRNO	E30NC230	1
1495009	CRNO	E28NC230	1

BEZELW

Okvir za termostat

Okvir za termostat serije EASY E20

Minimalistički i elegantan okvir za površinsku montažu regulatora temperature. Izdržljiv i čvrst. Omogućuje stabilnu ugradnju upravljačkog uređaja, savršeno nadopunjujući njegov dizajn u svakom interijeru.



ŠIFRA VOKEL	BOJA	ŠIFRA ARTIKLA	PAKIRANJE
1495012	BIJELA	BEZELW	1

BEZELB

Okvir za termostat

Okvir za termostat serije EASY E20

Minimalistički i elegantan okvir za površinsku montažu regulatora temperature. Izdržljiv i čvrst. Omogućuje stabilnu ugradnju upravljačkog uređaja, savršeno nadopunjujući njegov dizajn u svakom interijeru.



ŠIFRA VOKEL	BOJA	ŠIFRA ARTIKLA	PAKIRANJE
1495013	CRNA	BEZELB	1

ECB02M230

Modul za 2 kruga grijanja

Modul za 2 kruga grijanja s glavnom pumpom i regulacijom izvora grijanja.

Modul kruga grijanja omogućuje upravljanje dvjema neovisnim toplinskim zonama na koje su spojeni regulatori temperature i cirkulacijske pumpe.

Koristi se u standardom obiteljskom domu, gdje postoje podjele u 2 kruga

grijanja (npr. 1 krug prvog kata i 2 krug drugog kata). Tada signal koji dolazi iz bilo kojeg kruga grijanja aktivira izlaze prema glavnoj cirkulacijskoj pumpi i izvoru topline u regulatoru. Integrator se također može koristiti za male (npr. dvozonске) sustave podnog grijanja.

Napajanje	230V AC 50Hz
Maksimalna struja	3A
Izlazi	230V Bojler (NO/COM/NC10)
Dimenzije [mm]	150 x 90 x 35



ŠIFRA VOKEL	BOJA	ŠIFRA ARTIKLA	PAKIRANJE
1495014	CRNA	ECB02M230	1

E55B230WIFI

Ugradbeni WIFI termostat

Ugradbeni regulator temperature za ugradnju u okvir 55x55 mm.

Dizajniran za kontrolu površinskog zagrijavanja koje karakterizira visoka toplinska inercija. Također može kontrolirati bilo koju drugu vrstu grijanja, kao i sustave hlađenja – prema potrebama i postavkama korisnika.

Ugrađeni Wi-Fi modul omogućuje jednostavnu instalaciju i upravljanje sustavom grijanja pomoću mobilne aplikacije ENGO Smart.

Napajanje	230V AC 50Hz
Maksimalna struja	3 (1) A
Izlazni signal	NO/COM (beznaponski relej)
Raspon regulacije temperature	5 – 45°C
Prikaz točnosti temperature	0,1°C
Upravljački algoritam	Histereza (±0,2°C do ±2,0°C)
Komunikacija	Wi-Fi 2,4 GHz
Dimenzije [mm]	55 x 55 x 39 (17 nakon montaže u kutiju promjera 60)



ŠIFRA VOKEL	BOJA	ŠIFRA ARTIKLA	PAKIRANJE
1495015	CRNA	E55B230WIFI	1

E55W230WIFI

Ugradbeni WIFI termostat

Ugradbeni regulator temperature za ugradnju u okvir 55x55 mm.

Dizajniran za kontrolu površinskog zagrijavanja koje karakterizira visoka toplinska inercija. Također može kontrolirati bilo koju drugu vrstu grijanja, kao i sustave hlađenja – prema potrebama i postavkama korisnika.

Ugrađeni Wi-Fi modul omogućuje jednostavnu instalaciju i upravljanje sustavom grijanja pomoću mobilne aplikacije ENGO Smart.

Napajanje	230V AC 50Hz
Maksimalna struja	3 (1) A
Izlazni signal	NO/COM (beznaponski relej)
Raspon regulacije temperature	5 – 45°C
Prikaz točnosti temperature	0,1°C
Upravljački algoritam	Histereza (±0,2°C do ±2,0°C)
Komunikacija	Wi-Fi 2,4 GHz
Dimenzije [mm]	55 x 55 x 39 (17 nakon montaže u kutiju promjera 60)



ŠIFRA VOKEL	BOJA	ŠIFRA ARTIKLA	PAKIRANJE
1495016	BIJELA	E55W230WIFI	1



GAP

ŠIFRA VOKEL	OPIS	ART.
1109216	UMIVAONIK NADGRADNI GAP S RUPOM ZA BATERIJU 55x40 cm	A327Y0000

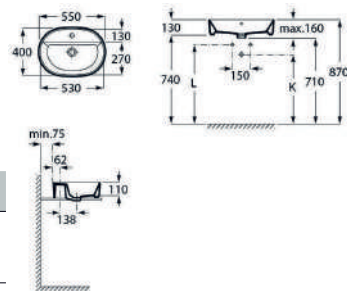

GAP

ŠIFRA VOKEL	OPIS	ART.
1109217	UMIVAONIK NADGRADNI GAP 55x39 cm	A327Y1000

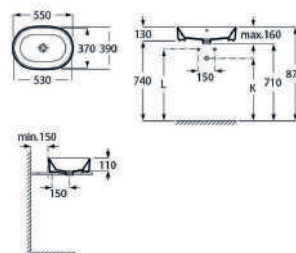

GAP

ŠIFRA VOKEL	OPIS	ART.
1109218	UMIVAONIK NADGRADNI GAP 60x37 cm	A3270Y2000

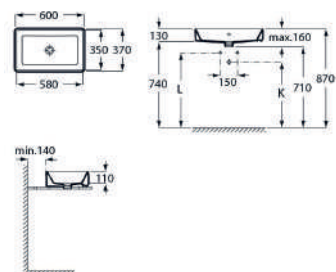

GAP

ŠIFRA VOKEL	OPIS	ART.
1109219	UMIVAONIK NADGRADNI GAP 60x42 cm	A3270MN000

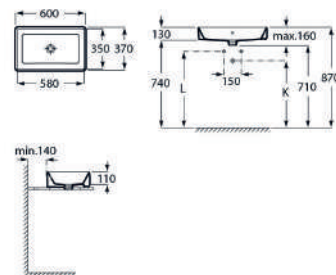

GAP

ŠIFRA VOKEL	OPIS	ART.
1109233	PODGRADNI UMIVAONIK SQUARE 55x35x16 cm	3270YF000

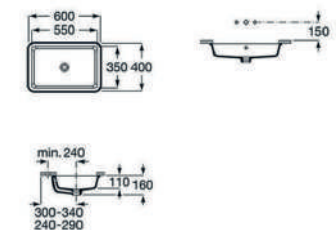

GAP

ŠIFRA VOKEL	OPIS	ART.
1109237	PODGRADNI OVALNI UMIVAONIK 55x35x16 cm	A3270YC000

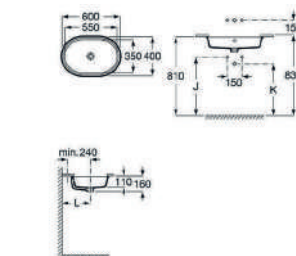



GAP

ŠIFRA VOKEL	OPIS	ART.
1109238	PODGRADNI UMIVAONIK 40x35x16 cm	A3270YE000

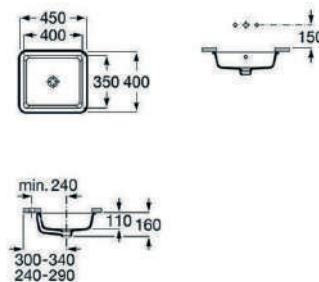

GAP

ŠIFRA VOKEL	OPIS	ART.
1109239	PODGRADNI OKRUGLI UMIVAONIK 35x35x16 cm	A3270YB000
1109240	PODGRADNI OKRUGLI UMIVAONIK 41x41x16,5 cm	A327884000

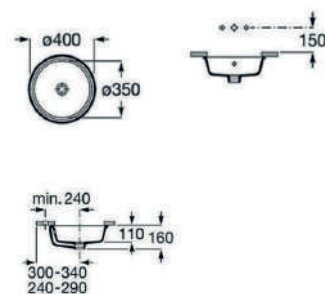

LAUFEN PRO S

ŠIFRA VOKEL	OPIS	ART.
1104085	PODGRADNI UMIVAONIK PRO S 52,5x40 cm, BEZ OTVORA ZA SLAVINU	8119610001091

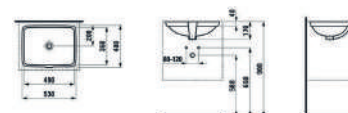

MARTAT

CONTEMPORARY BATHROOM

Kupaonski namještaj



ARMA 80

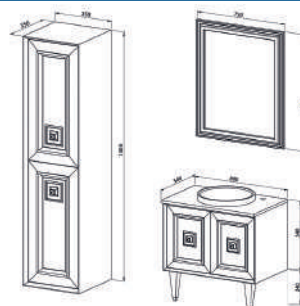

ŠIFRA VOKEL	OPIS	DIMENZIJE (mm)	ŠIFRA ARTIKLA	PAKIRANJE
1722026	ORMARIĆ ISPOD UMIVAONIKA ARMA 80 MATT ZELENI	800 x 500	M0003727	1
1722027	OGLEDALO ARMA MATT ZELENI	900 x 750	M0003736	1
1722028	BOČNI ORMAR ARMA TALL UNIT MATT ZELENI	1400 x 350 x 350	M0003733	1
1722039	MRAMORNA PLOČA ISPOD UMIVAONIKA ARMA 80	-	M0004074	1
1722040	POLUUGRADNI UMIVAONIK SANOVIT FI43 3041	-	H0004799	1

CAPELLA 120

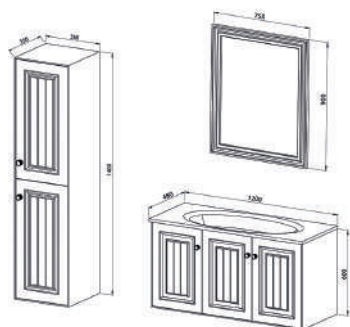

ŠIFRA VOKEL	OPIS	DIMENZIJE (mm)	ŠIFRA ARTIKLA	PAKIRANJE
1722023	ORMARIĆ ISPOD UMIVAONIKA CAPELLA 120 MATT PLAVI	1200 x 480	M0003769	1
1722024	OGLEDALO CAPELLA MATT PLAVI	900 x 750	M0003776	1
1722025	BOČNI ORMARIĆ CAPELLA TALL UNIT MATT PLAVI	1400 x 350 x 350	M0003772	1
1722038	UMIVAONIK KALE SPIRIT ETAJLERI	120 x 480	H0004832	1

CAPELLA 80

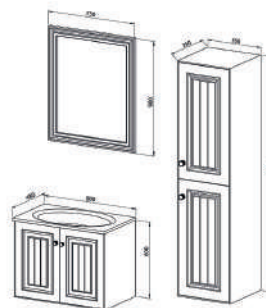

ŠIFRA VOKEL	OPIS	DIMENZIJE (mm)	ŠIFRA ARTIKLA	PAKIRANJE
1722045	ORMARIĆ ISPOD UMIVAONIKA CAPELLA 80 MATT PLAVI	800 x 480	M0003766	1
1722024	OGLEDALO CAPELLA MATT PLAVI	900 x 750	M0003776	1
1722025	BOČNI ORMARIĆ CAPELLA TALL UNIT MATT PLAVI	1400 x 350 x 350	M0003772	1
1722046	UMIVAONIK KALE SPIRIT ETAJLERI	800 x 480	H0004831	1

CAPELLA 120

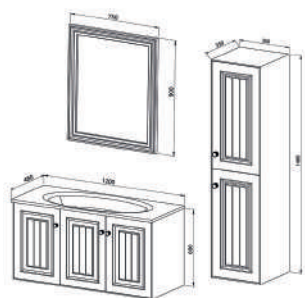

ŠIFRA VOKEL	OPIS	DIMENZIJE (mm)	ŠIFRA ARTIKLA	PAKIRANJE
1722054	ORMARIĆ ISPOD UMIVAONIKA CAPELLA 120 MATT LIGHT GREY	1200 x 480	M0003770	1
1722053	OGLEDALO CAPELLA MATT LIGHT GREY	900 x 750	M0003775	1
1722056	BOČNI ORMARIĆ CAPELLA TALL UNIT MATT LIGHT GREY	1400 x 350 x 350	M0003773	1
1722038	UMIVAONIK KALE SPIRIT ETAJLERI	120 x 480	H0004832	1

CAPELLA 80

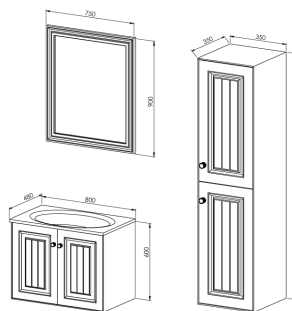

ŠIFRA VOKEL	OPIS	DIMENZIJE (mm)	ŠIFRA ARTIKLA	PAKIRANJE
1722055	ORMARIĆ ISPOD UMIVAONIKA CAPELLA 80 MATT LIGHT GREY	800 x 480	M0003767	1
1722053	OGLEDALO CAPELLA MATT LIGHT GREY	900 x 750	M0003775	1
1722056	BOČNI ORMARIĆ CAPELLA TALL UNIT MATT LIGHT GREY	1400 x 350 x 350	M0003773	1
1722046	UMIVAONIK KALE SPIRIT ETAJLERI	800 x 480	H0004831	1

VANITY 90

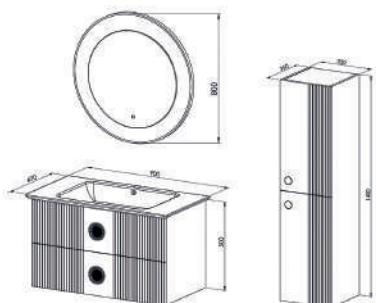

ŠIFRA VOKEL	OPIS	DIMENZIJE (mm/Ø)	ŠIFRA ARTIKLA	PAKIRANJE
1722021	ORMARIĆ ISPOD UMIVAONIKA VANITY 90 MATT SIVI	900 x 470	M0003717	1
1720021	OGLEDALO AMBER SA LED RASVJETOM	Ø80	S-4601 - 80	1
1722022	BOČNI ORMARIĆ VANITY TALL UNIT MATT SIVI	1400 x 350 x 350	M0003725	1
1722037	UMIVAONIK SANOVIT SHARP 14090	880 x 470	H0001527	1

ALEA 80

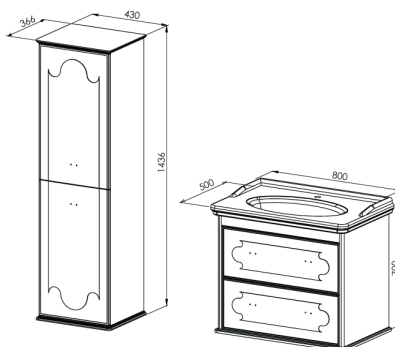

ŠIFRA VOKEL	OPIS	DIMENZIJE (mm)	ŠIFRA ARTIKLA	PAKIRANJE
1722058	ORMARIĆ ISPOD UMIVAONIKA ALEA 80 MATT SIVI	800 x 500	M0002948	1
1722057	OGLEDALO ALEA SIVO	750 x 1000	M0003085	1
1722060	BOČNI ORMARIĆ ALEA TALL UNIT MATT SIVI	1436 x 430 x 366	M0002951	1
1722059	UMIVAONIK KALE ARTDECO 80x50	800 x 500	H0001936	1

ROMA 120

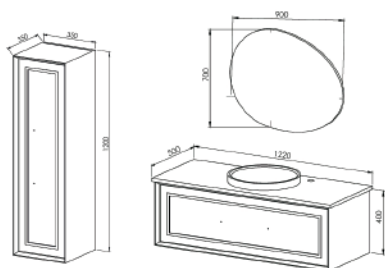

ŠIFRA VOKEL	OPIS	DIMENZIJE (mm)	ŠIFRA ARTIKLA	PAKIRANJE
1722064	ORMARIĆ ISPOD UMIVAONIKA ROMA 120	1200 x 500	M0004341	1
1722065	MRAMORNA PLOČA ISPOD UMIVAONIKA ARMA - ROMA 120	-	M0004075	1
1722040	POLUUGRADNI UMIVAONIK SANOVIT FI40 3041	Ø40	H0004799	1
1722066	BOČNI ORMARIĆ ROMA TALL UNIT MAT SIVI	1200 x 350 x 350	M0004342	1

ROMA 120

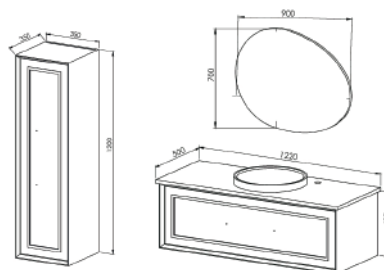

ŠIFRA VOKEL	OPIS	DIMENZIJE (mm)	ŠIFRA ARTIKLA	PAKIRANJE
1722067	ORMARIĆ ISPOD UMIVAONIKA ROMA MAT PLAVI 120	1200 x 500	M0004261	1
1722065	MRAMORNA PLOČA ISPOD UMIVAONIKA ARMA - ROMA 120	1200	M0004075	1
1722040	POLUUGRADNI UMIVAONIK SANOVIT	Ø43	H0004799	1
1722068	BOČNI ORMARIĆ ROMA TALL UNIT MAT PLAVI	1200 x 350 x 350	M0004263	1

ZEN 100

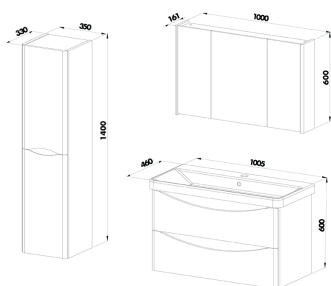

ŠIFRA VOKEL	OPIS	DIMENZIJE (mm)	ŠIFRA ARTIKLA	PAKIRANJE
1722014	ORMARIĆ ISPOD UMIVAONIKA ZEN 100 BIJELI	1005 x 460	M0003150	1
1722015	OGLEDALO-ORMARIĆ ZEN 100 BIJELI	1000 x 161	M0003168	1
1722020	BOČNI ORMARIĆ ZEN TALL UNIT BIJELI	1400 x 350 x 330	M0003171	1
1722034	UMIVAONIK SANOVIT LUXURY 11105	105 x 460	H0000983	1

ZEN 80

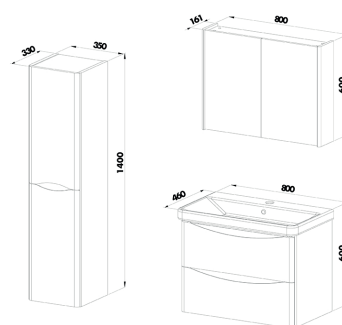

ŠIFRA VOKEL	OPIS	DIMENZIJE (mm)	ŠIFRA ARTIKLA	PAKIRANJE
1722016	ORMARIĆ ISPOD UMIVAONIKA ZEN 80 BIJELI	800 x 460	M0003128	1
1722017	OGLEDALO-ORMARIĆ ZEN 80 BIJELI	800 x 161	M0003155	1
1722020	BOČNI ORMARIĆ ZEN TALL UNIT BIJELI	1400 x 350 x 330	M0003171	1
1722035	UMIVAONIK SANOVIT LUXURY 11080	805 x 460	H0000982	1

ZEN 60

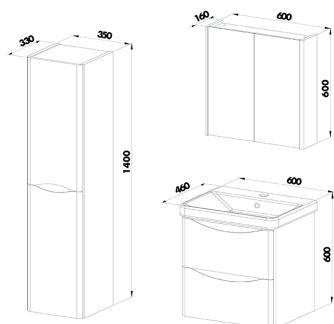

ŠIFRA VOKEL	OPIS	DIMENZIJE (mm)	ŠIFRA ARTIKLA	PAKIRANJE
1722018	ORMARIĆ ISPOD UMIVAONIKA ZEN 60 BIJELI	600 x 460	M0003126	1
1722019	OGLEDALO-ORMARIĆ ZEN 60 BIJELI	600 x 160	M0003164	1
1722020	BOČNI ORMARIĆ ZEN TALL UNIT BIJELI	1400 x 350 x 330	M0003171	1
1722036	UMIVAONIK SANOVIT LUXURY 60 11060	605 x 460	H0000981	1



ZEN 40

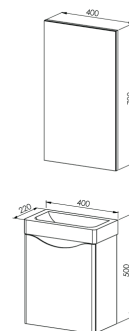

ŠIFRA VOKEL	OPIS	DIMENZIJE (mm)	ŠIFRA ARTIKLA	PAKIRANJE
1722061	ORMARIĆ ISPOD UMIVAONIKA ZEN 40	400x220	M0004298	1
1722062	UMIVAONIK LITOS 2240	400x220	H0002239	1
1722063	OGLEDALO ZEN	400x700	M0004299	1

RIO 55

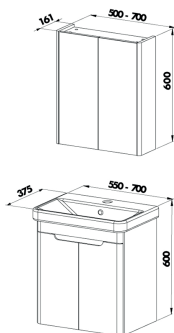

ŠIFRA VOKEL	OPIS	DIMENZIJE (mm)	ŠIFRA ARTIKLA	PAKIRANJE
1722012	ORMARIĆ ISPOD UMIVAONIKA RIO 55 BIJELI	550 x 375	M0004001	1
1722013	OGLEDALO-ORMARIĆ RIO 55 BIJELI	550 x 161	M0003938	1
1722033	UMIVAONIK SANOVIT LUXURY 11055	550 x 370	H0002008	1



SOFIA 80

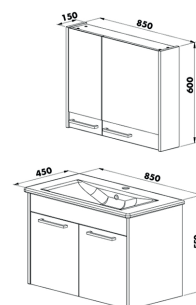

ŠIFRA VOKEL	OPIS	DIMENZIJE (mm)	ŠIFRA ARTIKLA	PAKIRANJE
1722003	ORMARIĆ ISPOD UMIVAONIKA SOFIA 80 PLAVI	850 x 450	M0003831	1
1722004	OGLEDALO-ORMARIĆ SOFIA 80 PLAVI	850 x 150	M0003850	1
1722005	BOČNI ORMARIĆ SOFIA TALL UNIT PLAVI	1400 x 350 x 300	M0003838	1
1722095	UMIVAONIK SANOVIT SOFT	800 x 450	H0000985	1

SOFIA 80

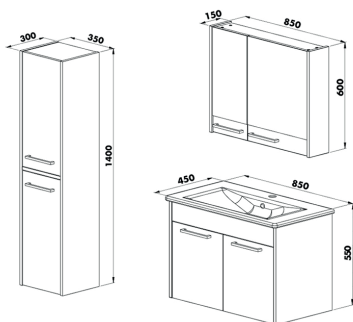

ŠIFRA VOKEL	OPIS	DIMENZIJE (mm)	ŠIFRA ARTIKLA	PAKIRANJE
1722006	ORMARIĆ ISPOD UMIVAONIKA SOFIA 80 TAMNO SIVI	850 x 450	M0003829	1
1722007	OGLEDALO-ORMARIĆ SOFIA 80 TAMNO SIVI	850 x 150	M0003852	1
1722008	BOČNI ORMARIĆ SOFIA TALL UNIT TAMNO SIVI	1400 x 350 x 300	M0003840	1
1722095	UMIVAONIK SANOVIT SIFT	800 x 450	H0000985	1

SOFIA 80



ŠIFRA VOKEL	OPIS	DIMENZIJE (mm)	ŠIFRA ARTIKLA	PAKIRANJE
1722009	ORMARIĆ ISPOD UMIVAONIKA SOFIA 80 ZELENI	850 x 450	M0003832	1
1722010	OGLEDALO-ORMARIĆ SOFIA 80 ZELENI	850 x 150	M0003849	1
1722011	BOČNI ORMARIĆ SOFIA TALL UNIT ZELENI	1400 x 350 x 300	M0003837	1
1722095	UMIVAONIK SANOVIT SOFT	800 x 450	H0000985	1

STRADA 55

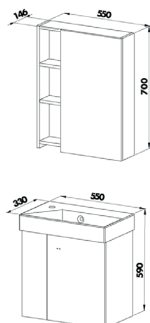

ŠIFRA VOKEL	OPIS	DIMENZIJE (mm)	ŠIFRA ARTIKLA	PAKIRANJE
1722001	ORMARIĆ ISPOD UMIVAONIKA STRADA BIJELI 55	550 x 330	M0002991	1
1722002	OGLEDALO-ORMARIĆ STRADA 55 BIJELI	550 x 146	M0002992	1
1722031	UMIVAONIK STANCE, SANOVIT 17055	550 x 330	H0001941	1



VENNA 80

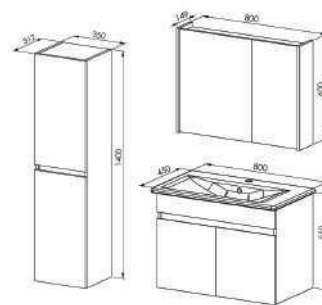

ŠIFRA VOKEL	OPIS	DIMENZIJE (mm)	ŠIFRA ARTIKLA	PAKIRANJE
1722094	ORMARIĆ ISPOD UMIVAONIKA VENNA 80 BIJELI	850 x 450	M0004393	1
1722047	OGLEDALO-ORMARIĆ VEGA 80 BIJELI	800 x 600	M0003300	1
1722096	BOČNI ORMARIĆ VENNA TALL UNIT BIJELI	1400 x 350 x 312	M0004463	1
1722095	UMIVAONIK SANOVIT SOFT	800 x 450	H0000985	1

VENNA 65

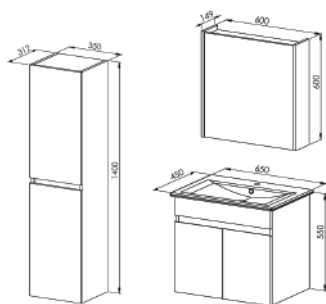

ŠIFRA VOKEL	OPIS	DIMENZIJE (mm)	ŠIFRA ARTIKLA	PAKIRANJE
1722092	ORMARIĆ ISPOD UMIVAONIKA VENNA 65 BIJELI	650 x 450	M0004391	1
1722041	OGLEDALO-ORMARIĆ VEGA 60 BIJELI	600 x 150	M0003299	1
1722093	UMIVAONIK SANOVIT SOFT	650 x 450	H0000984	1
1722096	BOČNI ORMARIĆ VENNA TALL UNIT BIJELI	1400 x 350 x 312	M0004463	1



VENNA 55

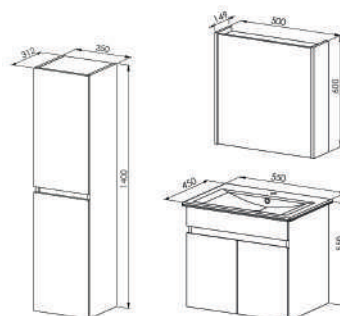

ŠIFRA VOKEL	OPIS	DIMENZIJE (mm)	ŠIFRA ARTIKLA	PAKIRANJE
1722091	ORMARIĆ ISPOD UMIVAONIKA VENNA 55 BIJELI	550 x 450	M0004389	1
1722042	OGLEDALO-ORMARIĆ VEGA 50 BIJELI	500 x 150	M0003298	1
1722044	UMIVAONIK SANOVIT ATRIA 9055	550 x 455	H0001664	1
1722096	BOČNI ORMARIĆ VENNA TALL UNIT BIJELI	1400 x 350 x 312	M0004463	1

PERA 45

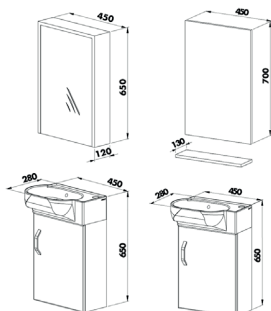

ŠIFRA VOKEL	OPIS	DIMENZIJE (mm)	ŠIFRA ARTIKLA	PAKIRANJE
1722051	ORMARIĆ ISPOD UMIVAONIKA PERA 45 BIJELI	450 x 280	M0004073	1
1722050	OGLEDALO-ORMARIĆ PERA 45 BIJELI		M0004104	1
1722052	UMIVAONIK SANOVIT 3045	450 x 280	H0001199	1

elba



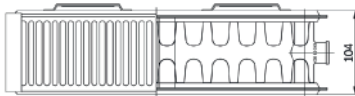

Kompaktni radijatori Tip 22 2 panela, 2konvektora					
		Vokel šifra			
		300	500	600	900
dužina (mm)	400				1474020
	500			1474001	
	600			1474002	1474021
	800			1474003	1474022
	1000	1474016	1474010	1474004	1474023
	1200	1474017	1474011	1474005	
	1400		1474012	1474006	
	1600	1474018	1474013	1474007	
	1800	1474019	1474014	1474008	
	2000		1474015	1474009	

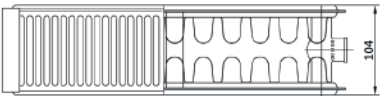
Ventilski radijatori Tip 22 2 panela, 2konvektora					
		Vokel šifra			
		300	500	600	900
dužina (mm)	400				1473020
	500			1473001	
	600			1473002	1473021
	800			1473003	1473022
	1000	1473016	1473010	1473004	1473023
	1200	1473017	1473011	1473005	
	1400		1473012	1473006	
	1600	1473018	1473013	1473007	
	1800	1473019	1473014	1473008	
	2000		1473015	1473009	

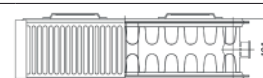
Kompaktni radijatori Tip 22: 2 panela, 2konvektora

ŠIFRA VOKEL	OPIS	PAKIRANJE (KOM/PAL)	DIMENZIJA	ART.
1474001	Radijator Elba-Smart kompakt	32	K22 H600 L500	1542112260050
1474002	Radijator Elba-Smart kompakt	32	K22 H600 L600	1542112260060
1474003	Radijator Elba-Smart kompakt	32	K22 H600 L800	1542112260080
1474004	Radijator Elba-Smart kompakt	32	K22 H600 L1000	1542112260100
1474005	Radijator Elba-Smart kompakt	32	K22 H600 L1200	1542112260120
1474006	Radijator Elba-Smart kompakt	32	K22 H600 L1400	1542112260140
1474007	Radijator Elba-Smart kompakt	26	K22 H600 L1600	1542112260160
1474008	Radijator Elba-Smart kompakt	26	K22 H600 L1800	1542112260180
1474009	Radijator Elba-Smart kompakt	26	K22 H600 L2000	1542112260200
1474010	Radijator Elba-Smart kompakt	16	K22 H500 L1000	1542112250100
1474011	Radijator Elba-Smart kompakt	16	K22 H500 L1200	1542112250120
1474012	Radijator Elba-Smart kompakt	16	K22 H500 L1400	1542112250140
1474013	Radijator Elba-Smart kompakt	13	K22 H500 L1600	1542112250160
1474014	Radijator Elba-Smart kompakt	13	K22 H500 L1800	1542112250180
1474015	Radijator Elba-Smart kompakt	13	K22 H500 L2000	1542112250200
1474016	Radijator Elba-Smart kompakt	-	K22 H300 L1000	1542112230100
1474017	Radijator Elba-Smart kompakt	-	K22 H300 L1200	1542112230120
1474018	Radijator Elba-Smart kompakt	-	K22 H300 L1600	1542112230160
1474019	Radijator Elba-Smart kompakt	-	K22 H300 L1800	1542112230180
1474020	Radijator Elba-Smart kompakt	16	K22 H900 L400	1542112290040
1474021	Radijator Elba-Smart kompakt	16	K22 H900 L600	1542112290060
1474022	Radijator Elba-Smart kompakt	16	K22 H900 L800	1542112290080
1474023	Radijator Elba-Smart kompakt	16	K22 H900 L1000	1542112290100

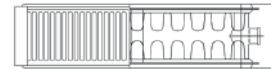

Ventilski radijatori Tip 22: 2panela, 2konvektora

ŠIFRA VOKEL	OPIS	PAKIRANJE (KOM/PAL)	DIMENZIJA	ART.
1473001	Radijator Elba-Smart ventilski	32	V22 H600 L500	1542642260050
1473002	Radijator Elba-Smart ventilski	32	V22 H600 L600	1542642260060
1473003	Radijator Elba-Smart ventilski	32	V22 H600 L800	1542642260080
1473004	Radijator Elba-Smart ventilski	32	V22 H600 L1000	1542642260100
1473005	Radijator Elba-Smart ventilski	32	V22 H600 L1200	1542642260120
1473006	Radijator Elba-Smart ventilski	32	V22 H600 L1400	1542642260140
1473007	Radijator Elba-Smart ventilski	26	V22 H600 L1600	1542642260160
1473008	Radijator Elba-Smart ventilski	26	V22 H600 L1800	1542642260180
1473009	Radijator Elba-Smart ventilski	26	V22 H600 L2000	1542642260200
1473010	Radijator Elba-Smart ventilski	16	V22 H500 L1000	1542642250100
1473011	Radijator Elba-Smart ventilski	16	V22 H500 L1200	1542642250120
1473012	Radijator Elba-Smart ventilski	16	V22 H500 L1400	1542642250140
1473013	Radijator Elba-Smart ventilski	13	V22 H500 L1600	1542642250160
1473014	Radijator Elba-Smart ventilski	13	V22 H500 L1800	1542642250180
1473015	Radijator Elba-Smart ventilski	13	V22 H500 L2000	1542642250200
1473016	Radijator Elba-Smart ventilski	-	V22 H300 L1000	1542642230100
1473017	Radijator Elba-Smart ventilski	-	V22 H300 L1200	1542642230120
1473018	Radijator Elba-Smart ventilski	-	V22 H300 L1600	1542642230160
1473019	Radijator Elba-Smart ventilski	-	V22 H300 L1800	1542642230180
1473020	Radijator Elba-Smart ventilski	16	V22 H900 L400	1542642290040
1473021	Radijator Elba-Smart ventilski	16	V22 H900 L600	1542642290060
1473022	Radijator Elba-Smart ventilski	16	V22 H900 L800	1542642290080
1473023	Radijator Elba-Smart ventilski	16	V22 H900 L1000	1542642290100

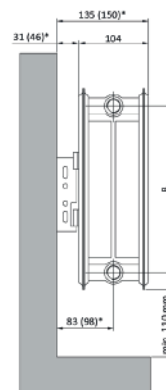
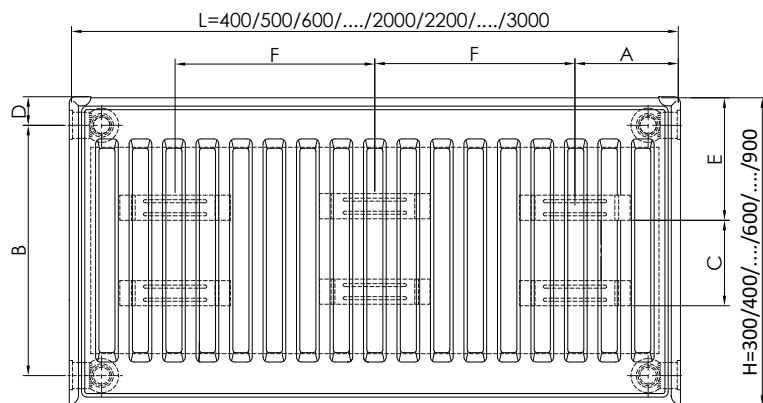
Mjere za montažu radijatora

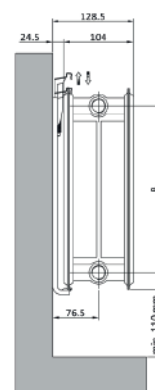

TIP :22-PKKP



TIP :22-PKKP

Tehnički podaci

DIMENZIJE PANELNIH RADIJATORA

TIP	11 - 21 - 22 - 33			
L (mm)	400-500-600...-2000-2200-...-3000		H (mm)	300-400-500-600-700-800-900
A (mm)	101 (Tip 11 = 117 mm)		B (mm)	249-349-449-549-649-749-849
C (mm)	85-185-285-385-485-585-685		D (mm)	26
E (mm)	120		F (mm)	(L - 2A) / 2

BROJ DRŽAČA

L = 400-500-600-...-1600 mm	4 kom
L = 1700-1800-1900-...-3000	6 kom

SPECIFIKACIJA I DEBLJINA MATERIJALA RADIJATORA

MATERIJAL	DEBLJINA	SPECIFIKACIJE (standard)
PANEL	1,15 mm	DIN EN 10130DC 01 QUALITY
KONVEKTOR	0,25 mm	DIN EN 10130 DC 01 QUALITY
POKLOPAC	0,60 mm	DIN EN 10130 DC 01 QUALITY
BOČNI POKLOPAC	0,50 mm	DIN EN 10130 DC 01 QUALITY

TIP	300		400		500		600		700		800		900	
	Težina kg/m	Volumen lt/m	Težina kg/m	Volumen lt/m	Težina kg/m	Volumen lt/m	Težina kg/m	Volumen lt/m	Težina kg/m	Volumen lt/m	Težina kg/m	Volumen lt/m	Težina kg/m	Volumen lt/m
11 (PK)	7,79	1,73	10,29	2,12	12,79	2,58	15,30	3,00	17,80	3,40	20,30	3,90	22,81	4,30
21 (PKP)	13,16	3,39	17,35	4,17	21,54	5,08	25,72	5,92	29,91	6,80	34,10	7,72	38,29	8,87
22 (PKKP)	14,60	3,42	19,28	4,22	23,96	5,13	28,63	5,97	33,31	6,84	37,99	7,77	42,67	8,92
33 (PKKPKP)	21,68	5,08	28,68	6,25	35,52	7,61	42,49	8,87	49,47	10,24	56,44	11,57	63,41	13,17

Visina (mm)	300	400	500	600	700	800	900
B mm	249	349	449	549	649	749	849
L ₁₁ mm	400-3000	400-3000	400-3000	400-3000	400-3000	400-3000	400-3000
L ₂₁ mm	400-3000	400-3000	400-3000	400-3000	400-3000	400-3000	400-3000
L ₂₂ mm	400-3000	400-3000	400-3000	400-3000	400-3000	400-3000	400-3000
L ₃₃ mm	400-3000	400-3000	400-3000	400-3000	400-2400	400-2000	400-1800

Dužina (mm)	Snaga (W)	Vokel šifra			
		300	500	600	900
400	75/65/20°C				920
	90/70/20°C				1168
500	75/65/20°C			829	
	90/70/20°C			1051	
600	75/65/20°C			995	1379
	90/70/20°C			1261	1751
800	75/65/20°C			1326	1839
	90/70/20°C			1682	2335
1000	75/65/20°C	923	1425	1658	2299
	90/70/20°C	1177	1810	2102	2919
1200	75/65/20°C	1108	1710	1990	
	90/70/20°C	1412	2172	2522	
1400	75/65/20°C		1995	2321	
	90/70/20°C		2534	2943	
1600	75/65/20°C	1477	2280	2653	
	90/70/20°C	1883	2896	3363	
1800	75/65/20°C	1661	2565	2984	
	75/65/20°C	2119	3258	3784	
2000	75/65/20°C		2850	3316	
	90/70/20°C		3620	4204	

Aria

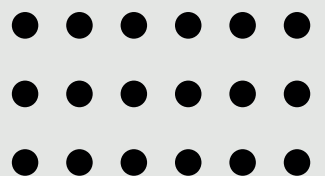



MISTRAL

VORTEX ISPIRANJE - ISPIRANJE S JEDNOM RUPOM

ŠIFRA VOKEL	OPIS	ART.
1731001	VIŠEĆA WC ŠKOLJKA BEZ DASKE	KW-9003W
1731002	WC DASKA SOFTCLOSE	KW-9003W

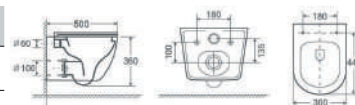

KALIOPA WHITE RIMLESS

ŠIFRA VOKEL	OPIS	ART.
1724001	VIŠEĆA WC ŠKOLJKA BEZ DASKE	B2342
1724002	WC DASKA SOFTCLOSE	051

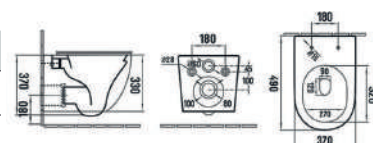

KALIOPA

VIŠEĆI BIDE

ŠIFRA VOKEL	OPIS	ART.
1724041	VIŠEĆI BIDE - BIJELI	B2342BD



KALIOPA LIGHT GREY RIMLESS

ŠIFRA VOKEL	OPIS	ART.
1724003	VIŠEĆA WC ŠKOLJKA BEZ DASKE	B2342MH
1724004	WC DASKA SOFTCLOSE	051MH

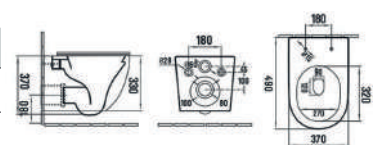

KALIOPA

VIŠEĆI BIDE

ŠIFRA VOKEL	OPIS	ART.
1724042	VIŠEĆI BIDE LIGHT GREY MAT	B2342BDMH



KALIOPA CAPPUCCINO RIMLESS

VIŠEĆA WC ŠKOLJKA

ŠIFRA VOKEL	OPIS	ART.
1724005	VIŠEĆA WC ŠKOLJKA BEZ DASKE	B2342MC
1724006	WC DASKA SOFTCLOSE	051MC

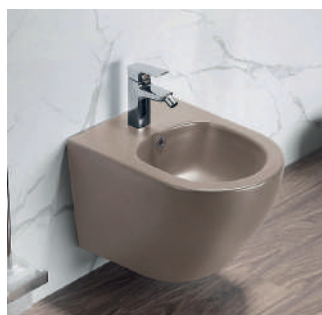
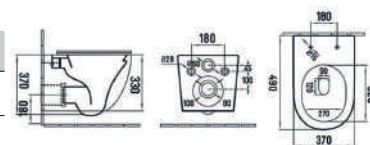

KALIOPA

VIŠEĆI BIDE

ŠIFRA VOKEL	OPIS	ART.
1724043	VIŠEĆI BIDE CAPPUCCINO MATT	B2342BDMC



KALIOPA BLACK RIMLESS

VIŠEĆA WC ŠKOLJKA

ŠIFRA VOKEL	OPIS	ART.
1724007	VIŠEĆA WC ŠKOLJKA BEZ DASKE	B2342MB
1724008	WC DASKA SOFTCLOSE	051MB

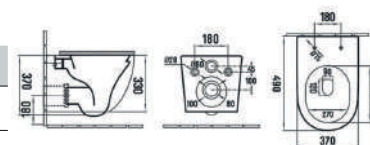

KALIOPA

VIŠEĆI BIDE

ŠIFRA VOKEL	OPIS	ART.
1724044	VIŠEĆI BIDE BLACK MATT	B2342BDMB



PENELOPA WHITE RIMLESS

VIŠEĆA WC ŠKOLJKA

ŠIFRA VOKEL	OPIS	ART.
1724064	VIŠEĆA WC ŠKOLJKA BEZ DASKE	B2351
1724065	WC DASKA SOFTCLOSE	068

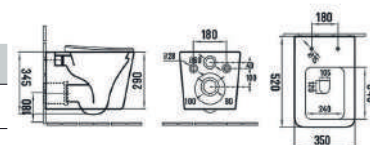



PENELOPA
VISEĆI BIDE

ŠIFRA VOKEL	OPIS	ART.
1724079	VISEĆI BIDE PENELOPA BIJELI	B2351BD



PENELOPA BLACK RIMLESS
VISEĆA WC ŠKOLJKA

ŠIFRA VOKEL	OPIS	ART.
1724083	VISEĆA WC ŠKOLJKA BEZ DASKE	B2351MB
1724084	WC DASKA SOFTCLOSE	068MB

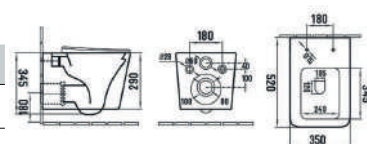

PENELOPA
VISEĆI BIDE

ŠIFRA VOKEL	OPIS	ART.
1724085	VISEĆI BIDE BLACK MATT	B2351BDMB



TALIIJA WHITE RIMLESS
VISEĆA WC ŠKOLJKA

ŠIFRA VOKEL	OPIS	ART.
1724039	VISEĆA WC ŠKOLJKA BEZ DASKE	B2353
1724040	WC DASKA SOFTCLOSE	C050

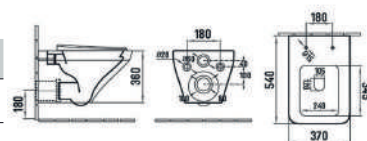

PISOAR CORAL WHITE
SA SENZOROM, SIFONOM, PILETOM I PRIBOROM ZA MONTAŽU

ŠIFRA VOKEL	OPIS	DIMENZIJA (cm)	NAPAJANJE	ART.
1724076	PISOAR CORAL WHITE	34x37x78	BATERIJSKO	X571-S



PISOAR CORAL WHITE

SA SIFONOM, KERAMIČKIM POKROVOM I PRIBOROM ZA MONTAŽU

ŠIFRA VOKEL	OPIS	DIMENZIJA (cm)	ART.
1724077	PISOAR CORAL WHITE	34x37x78	X571



PISOAR CORAL BLACK

SA SIFONOM, KERAMIČKIM POKROVOM I PRIBOROM ZA MONTAŽU

ŠIFRA VOKEL	OPIS	DIMENZIJA (cm)	ART.
1724087	PISOAR CORAL BLACK	34X37X78	X571MB



MAK

WC ČUČAVAC

ŠIFRA VOKEL	OPIS	DIMENZIJA (cm)	ART.
1724078	WC ČUČAVAC MAK WHITE	52x42x19	105



GEA WHITE

NADPULTNI 60x40 cm

ŠIFRA VOKEL	BOJA	DIMENZIJA (cm)	ART.
1724009	BIJELI	60x40	78239



GEA LIGHT GREY S PILETOM U ISTOJ BOJI

NADPULTNI 60x40 cm

ŠIFRA VOKEL	BOJA	DIMENZIJA (cm)	ART.
1724010	LIGHT GREY	60x40	78239MH



GEA BROWN S PILETOM U ISTOJ BOJI

NADPULTNI 60x40 cm

ŠIFRA VOKEL	BOJA	DIMENZIJA (cm)	ART.
1724011	BROWN	60x40	78239MDB



GEA CAPPUCCINO S PILETOM U ISTOJ BOJI

NADPULTNI 60x40 cm

ŠIFRA VOKEL	BOJA	DIMENZIJA (cm)	ART.
1724012	CAPPUCCINO	60x40	78239MC



GEA DARK GREEN S PILETOM U ISTOJ BOJI

NADPULTNI 60x40 cm

ŠIFRA VOKEL	BOJA	DIMENZIJA (cm)	ART.
1724013	DARK GREEN	60x40	78239MDG



GEA BLACK S PILETOM U ISTOJ BOJI

NADPULTNI 60x40 cm

ŠIFRA VOKEL	BOJA	DIMENZIJA (cm)	ART.
1724014	BLACK	60x40	78239MB



NUBIA WHITE

NADPULTNI 50x39

ŠIFRA VOKEL	BOJA	DIMENZIJA (cm)	ART.
1724031	WHITE	50x39	78109
1724073	MATT WHITE	50x39	78109MW



NUBIA DARK GREEN S PILETOM U ISTOJ BOJI

NADPULTNI 59x39

ŠIFRA VOKEL	BOJA	DIMENZIJA (cm)	ART.
1724032	DARK GREEN	50x39	78109MDG



NUBIA LIGHT GREY S PILETOM U ISTOJ BOJI

NADPULTNI 50x39 cm

ŠIFRA VOKEL	BOJA	DIMENZIJA (cm)	ART.
1724033	LIGHT GREY	50x39	78109MH



NUBIA BROWN S PILETOM U ISTOJ BOJI

NADPULTNI 50x39 cm

ŠIFRA VOKEL	BOJA	DIMENZIJA (cm)	ART.
1724034	BROWN	50x39	78109MDB



NUBIA CAPPUCCINO S PILETOM U ISTOJ BOJI

NADPULTNI 50x39 cm

ŠIFRA VOKEL	BOJA	DIMENZIJA (cm)	ART.
1724035	CAPPUCCINO	50x39	78109MC



NUBIA BLACK S PILETOM U ISTOJ BOJI

NADPULTNI 50x39 cm

ŠIFRA VOKEL	BOJA	DIMENZIJA (cm)	ART.
1724036	BLACK	50x39	78109MB



SWAN GOLD/BLUE

NADPULTNI Ø 40,5

ŠIFRA VOKEL	BOJA	DIMENZIJA (Ø)	ART.
1724016	GOLD/BLUE	40,5	J2111



TANA BLACK/BRONZE

NADPULTNI Ø 43,5

ŠIFRA VOKEL	BOJA	DIMENZIJA (Ø)	ART.
1724017	BLACK/BRONZE	43,5	J2091



TANA WHITE/BRONZE

NADPULTNI Ø 41

ŠIFRA VOKEL	BOJA	DIMENZIJA (Ø)	ART.
1724018	WHITE/BRONZE	41	J2094



ONTARIO GOLD/WHITE

NADPULTNI 45x40 cm

ŠIFRA VOKEL	BOJA	DIMENZIJA (cm)	ART.
1724019	GOLD/WHITE	45x40	78322



BROA WHITE

NADPULTNI 60x38 cm

ŠIFRA VOKEL	BOJA	DIMENZIJA (cm)	ART.
1724020	WHITE	60x38	C1098



CEDAR STATUARIO

NADPULTNI 45,5x32,5 cm

ŠIFRA VOKEL	BOJA	DIMENZIJA (cm)	ART.
1724021	STATUARIO	45,5x32,5	C1013



CEDAR CALACATTA

NADPULTNI 45,5x32,5 cm

ŠIFRA VOKEL	BOJA	DIMENZIJA (cm)	ART.
1724022	CALACATTA	45,5x32,5	C1012



EVORON WHITE

NADPULTNI 65x33,5

ŠIFRA VOKEL	BOJA	DIMENZIJA (cm)	ART.
1724023	WHITE	65x33,5	7756B



IBERA WHITE

NADPULTNI 60x40

ŠIFRA VOKEL	BOJA	DIMENZIJA (cm)	ART.
1724024	WHITE	60x40	7680



LA PLATA WHITE

NADPULTNI 59x38

ŠIFRA VOKEL	BOJA	DIMENZIJA (cm)	ART.
1724025	WHITE	59x38	78390



NASSER WHITE

NADPULTNI 72,5x37 cm

ŠIFRA VOKEL	BOJA	DIMENZIJA (cm)	ART.
1724026	WHITE	72,5x37	7811B



SEUL BLACK S PILETOM U ISTOJ BOJI

NADPULTNI 52x39,5 cm

ŠIFRA VOKEL	BOJA	DIMENZIJA (cm)	ART.
1724027	BLACK	52x39,5	78166MMB



ROSANA LIGHT GREY S PILETOM U ISTOJ BOJI

NADPULTNI 60x41,5

ŠIFRA VOKEL	BOJA	DIMENZIJA (cm)	ART.
1724030	LIGHT GREY	60x41,5	78326MH



ROSANA WHITE MATT

NADPULTNI 60x41,5 cm

ŠIFRA VOKEL	BOJA	DIMENZIJA (cm)	ART.
1724072	WHITE	60x41,5	78326MW



ROSANA BLACK S PILETOM U ISTOJ BOJI

NADPULTNI 60x41,5 cm

ŠIFRA VOKEL	BOJA	DIMENZIJA (cm)	ART.
1724028	BLACK	60x41,5	78326MB



ROSANA BLACK/WHITE

NADPULTNI 60x41,5 cm

ŠIFRA VOKEL	BOJA	DIMENZIJA (cm)	ART.
1724029	BLACK/WHITE	60x41,5	78326MBW



TUMBA WHITE

LIJEVI 40,5x28 cm

ŠIFRA VOKEL	BOJA	DIMENZIJA (cm)	ART.
1724045	WHITE	40,5x28	78404L



TUMBA WHITE

DESNI 40,5x28 cm

ŠIFRA VOKEL	BOJA	DIMENZIJA (cm)	ART.
1724046	WHITE	40,5x28	78404R



OHRID BLACK

NADPULTNI 61x35 cm

ŠIFRA VOKEL	BOJA	DIMENZIJA (cm)	ART.
1724047	BLACK	61x35	78626

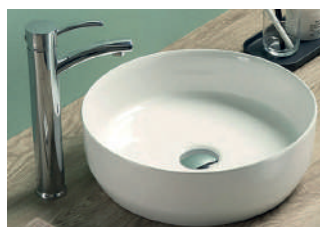

TRIBIS WHITE

NADPULTNI Ø39

ŠIFRA VOKEL	BOJA	DIMENZIJA (Ø)	ART.
1724048	WHITE	39	112D
1724074	MATT WHITE	39	112DMW



COMO WHITE

NADPULTNI Ø36

ŠIFRA VOKEL	BOJA	DIMENZIJA (Ø)	ART.
1724049	WHITE	36	78435



URMIA STONE

NADPULTNI 50,5x38 cm

ŠIFRA VOKEL	BOJA	DIMENZIJA (cm)	ART.
1724050	STONE	50,5x38	C78328M-Y1



LUGANO WHITE/SILVER

NADPULTNI 50,5x40,5 cm

ŠIFRA VOKEL	BOJA	DIMENZIJA (cm)	ART.
1724051	WHITE/SILVER	50,5x40,5	C1071



ARAL WHITE

STOJEĆI 40x40x83 cm

ŠIFRA VOKEL	BOJA	DIMENZIJA (cm)	ART.
1724052	WHITE	40x40x83	B169-1



LAGUNA WHITE

STOJEĆI 46x44x82 cm

ŠIFRA VOKEL	BOJA	DIMENZIJA (cm)	ART.
1724053	WHITE	46x44x82	B135-1



KRISTALL WHITE

NADPULTNI Ø36

ŠIFRA VOKEL	BOJA	DIMENZIJA (Ø)	ART.
1724054	WHITE	36	GL01

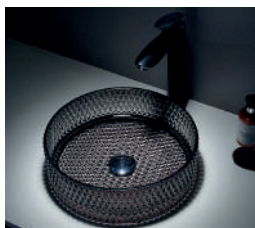

KRISTALL BLACK

NADPULTNI Ø36

ŠIFRA VOKEL	BOJA	DIMENZIJA (Ø)	ART.
1724055	BLACK	36	GL03



KRISTALL GOLD

NADPULTNI Ø36

ŠIFRA VOKEL	BOJA	DIMENZIJA (ø)	ART.
1724056	GOLD	36	GL05



HANNA GOLD

NADPULTNI Ø40,5

ŠIFRA VOKEL	BOJA	DIMENZIJA (ø)	ART.
1724057	GOLD	40,5	7078AJ



NESSY WHITE

NADPULTNI 50, 60, 70 cm

ŠIFRA VOKEL	BOJA	DIMENZIJA (cm)	ART.
1724058	WHITE	50,5x38	78575B(50)
1724059	WHITE	61x38	78575B(60)
1724060	WHITE	70,5x38	78575B(70)



NESSY BLACK

NADPULTNI 50, 60, 70 cm

ŠIFRA VOKEL	BOJA	DIMENZIJA (cm)	ART.
1724061	BLACK	50,5x38	78575B(50)MB
1724062	BLACK	61x38	78575B(60)MB
1724063	BLACK	70,5x38	78575B(70)MB



URI MULTICOLOR

NADPULTNI 60x41,5 cm

ŠIFRA VOKEL	BOJA	DIMENZIJA (cm)	ART.
1724067	MULTICOLOR	60x41,5	C78326M-W21



FORMOSA WHITE

NADPULTNI 45,5x32,5 cm

ŠIFRA VOKEL	BOJA	DIMENZIJA (cm)	ART.
1724068	WHITE	40,5x32,5	78105



TEMPE WHITE

NADPULTNI 60x42,5 cm

ŠIFRA VOKEL	BOJA	DIMENZIJA (cm)	ART.
1724069	WHITE	60x42,5	78188



SALDA BLACK

NADPULTNI Ø41,5

ŠIFRA VOKEL	BOJA	DIMENZIJA (Ø)	ART.
1724070	BLACK	41,5	78115MB



ISEO

NADPULTNI 50,4x35,2

ŠIFRA VOKEL	BOJA	DIMENZIJA (cm)	ART.
1724075	WHITE	50,4x35,2	78589



KARIBA

VIŠEĆI / NADPULTNI 50x35

ŠIFRA VOKEL	BOJA	DIMENZIJA (cm)	ART.
1724080	WHITE	50x35	7657D



VIDA

VIŠEĆI / NADPULTNI 50x38,5

ŠIFRA VOKEL	BOJA	DIMENZIJA (cm)	ART.
1724081	WHITE	50x38,5	78363



TAY

VIŠEĆI / NADPULTNI 40x30

ŠIFRA VOKEL	BOJA	DIMENZIJA (cm)	ART.
1724082	WHITE	40x30	7440C



REZERVNI VIJCI
ZA WC ŠKOLJKU

ŠIFRA VOKEL	OPIS	ART.
1731003	VIJCI ZA VISEĆU WC ŠKOLJKU MISTRAL	KW-827D



REZERVNI VIJCI
ZA WC DASKU

ŠIFRA VOKEL	OPIS	ART.
1731004	VIJCI ZA WC DASKU MISTRAL	-



REZERVNI VIJCI
ZA WC ŠKOLJKU

ŠIFRA VOKEL	OPIS	ART.
1724037	VIJCI ZA WC ŠKOLJKU KALIOPA, PENELOPA I TALIJA	BS-1



REZERVNI VIJCI
ZA WC DASKU

ŠIFRA VOKEL	OPIS	ART.
1724038	VIJCI ZA WC DASKU KALIOPA I PENELOPA	051-S



REZERVNI VIJCI
ZA WC DASKU

ŠIFRA VOKEL	OPIS	ART.
1724066	VIJCI ZA WC DASKU TALIJA	C050-S



RASPRŠIVAČ ZA PISOAR CORAL
SA SENZOROM

ŠIFRA VOKEL	OPIS	ART.
1724096	RASPRŠIVAČ SA SENZOROM ZA PISOAR CORAL(1724076)	X571-S SPRAYER

KERAMIČKI POKROV ZA PISOAR BLACK CORAL



ŠIFRA VOKEL	OPIS	ART.
1724091	KERAMIČKI POKROV ZA PISOAR BLACK CORAL (1724087)	X571MB CERAMIC COVER

KERAMIČKI POKROV ZA PISOAR WHITE CORAL



ŠIFRA VOKEL	OPIS	ART.
1724086	KERAMIČKI POKROV ZA PISOAR WHITE CORAL (1724076, 1724077)	X571 CERAMIC COVER

KUĆIŠTE ZA BATERIJU ZA PISOAR CORAL

SA SENZOROM



ŠIFRA VOKEL	OPIS	ART.
1724090	RASPRŠIVAČ SA SENZOROM ZA PISOAR CORAL (1724076)	X571-S BATTERY BOX

SIFON ZA PISOAR CORAL



ŠIFRA VOKEL	OPIS	ART.
1724088	SIFON ZA PISOAR CORAL 1724076, 1724077, 1724087	X571 P-TRAP FITTING

VENTIL ZA PISOAR CORAL

SA SENZOROM



ŠIFRA VOKEL	OPIS	ART.
1724093	VENTIL SA SENZOROM ZA PISOAR CORAL (1724076)	X571-S SENSOR VALVE

ULAZNA CIJEV ZA PISOAR CORAL

SA SENZOROM



ŠIFRA VOKEL	OPIS	ART.
1724094	ULAZNA CIJEV ZA PISOAR CORAL SA SENZOROM (1724076)	X571-S INLET PIPE

ULAZNA CIJEV ZA PISOAR CORAL



ŠIFRA VOKEL	OPIS	ART.
1724095	ULAZNA CIJEV ZA PISOAR CORAL (1724077, 1724087)	X571 INLET PIPE

PRETVARAČ ZA PISOAR CORAL

SA SENZOROM



ŠIFRA VOKEL	OPIS	ART.
1724097	PRETVARAČ ZA PISOAR CORAL SA SENZOROM (1724076)	X571-S TRANSFORMER

SENZOR ZA PISOAR CORAL



ŠIFRA VOKEL	OPIS	ART.
1724089	SENZOR ZA PISOAR CORAL SA SENZOROM (1724076)	X571-S SENSOR

REZERVNI VIJCI

ZA PISOAR CORAL



ŠIFRA VOKEL	OPIS	ART.
1724092	VIJCI ZA PISOAR CORAL (1724076, 1724077, 1724087)	X571 WALL HUNG FITTING

KERAMIČKA PILETA BLACK



ŠIFRA VOKEL	OPIS	ART.
1724098	KERAMIČKA PILETA BLACK BEZ RUPE ZA PRELJEV ZA UMIVAONIKE 1724014, 1724028, 1724036	T201MB-3

KERAMIČKA PILETA LIGHT GREY



ŠIFRA VOKEL	OPIS	ART.
1724099	KERAMIČKA PILETA LIGHT GREY BEZ RUPE ZA PRELJEV ZA UMIVAONIKE 1724010, 1724030, 1724033	T201MH-3



KERAMIČKA PILETA BROWN

ŠIFRA VOKEL	OPIS	ART.
1724100	KERAMIČKA PILETA BROWN BEZ RUPE ZA PRELJEV ZA UMIVAONIKE 1724011, 1724034	T201MDB-3



KERAMIČKA PILETA CAPPUCCINO

ŠIFRA VOKEL	OPIS	ART.
1724101	KERAMIČKA PILETA CAPPUCCINO BEZ RUPE ZA PRELJEV ZA UMIVAONIKE 1724012, 1724035	T201MC-3



KERAMIČKA PILETA DARK GREEN

ŠIFRA VOKEL	OPIS	ART.
1724102	KERAMIČKA PILETA DARK GREEN BEZ RUPE ZA PRELJEV ZA UMIVAONIKE 1724013, 1724032	T201MDG-3



KERAMIČKA PILETA BLACK MARBLE

ŠIFRA VOKEL	OPIS	ART.
1724103	KERAMIČKA PILETA BLACK MARBLE BEZ RUPE ZA PRELJEV ZA UMIVAONIK 1724027	T201M-B

ALATI I PRIBOR ZA KERAMIČARE

 **BIHUI**[®]

 **MAX**[®]



RUČNI REZAČ KERAMIKE TCM



ŠIFRA VOKEL	DUŽINA (mm)	ART.
1670115	700	27187
1670116	900	28038
1670117	1200	28039
1670118	1650	28043



PRIČUVNI NOŽIĆ TCM-SW

ŠIFRA VOKEL	DUBINA REZANJA (mm)	ART.
1670119	16	28064



DIJAMANTNA BRUSNO - REZNA PLOČA

ŠIFRA VOKEL	VELIČINA (mm)	ART.
1670001	125	47801

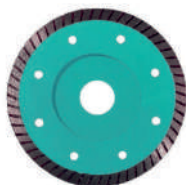

DIJAMANTNA REZNA PLOČA

ŠIFRA VOKEL	VELIČINA (mm)	ART.
1670002	115x1,4	47798



DIJAMANTNA REZNA PLOČA

ŠIFRA VOKEL	VELIČINA (mm)	ART.
1670108	115x1,4	47797



DIJAMANTNA REZNA PLOČA B-MASTER

ŠIFRA VOKEL	VELIČINA (mm)	ART.
1670003	115x1,2	47799



DIJAMANTNA REZNA PLOČA BEZ PROREZA

ŠIFRA VOKEL	VELIČINA (mm)	ART.
1670029	115x1,8	4938



DIJAMANTNA REZNA PLOČA S PROREZOM

ŠIFRA VOKEL	VELIČINA (mm)	ART.
1670030	115x1,8	4936



PLOČA ZA POLIRANJE

ŠIFRA VOKEL	VELIČINA (mm)	ART.
1670098	125x2	23580



REZNO - BRUSNA PLOČA

ŠIFRA VOKEL	VELIČINA (mm)	ART.
1670101	50	48770



DIJAMANTNI LAMELARNI BRUSNI DISK

ŠIFRA VOKEL	GRIT (GR)	VELIČINA (mm)	ART.
1670121	60	115	48775

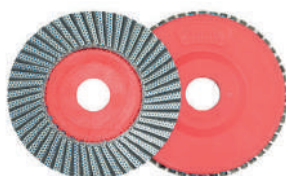

DIJAMANTNI LAMELARNI BRUSNI DISK

ŠIFRA VOKEL	GRIT (GR)	VELIČINA (mm)	ART.
1670122	200	115	48776



NOSAČ BRUSNOG DISKA - ČIČAK

ŠIFRA VOKEL	PROMJER (mm)	NAVOJ	ART.
1670127	100	M14	39699

DIJAMANTNI BRUSNI DISK - ČIČAK

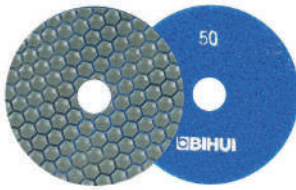

ŠIFRA VOKEL	GRIT (GR)	VELIČINA (mm)	ART.
1670128	50	100	39694
1670129	100	100	39695
1670130	200	100	39696
1670131	800	100	39697
1670132	1500	100	39698



DIJAMANTNA KRUNA SET 4u1

ŠIFRA VOKEL	VELIČINA (mm)	ART.
1670004	25 - 40 - 60 - 70	47845



DIJAMANTNA KRUNA ZA BUŠILICU

ŠIFRA VOKEL	VELIČINA (mm)	ART.
1670017	6	47893
1670020	8	47894
1670007	10	47895
1670010	12	47896

DIJAMANTNA KRUNA M14



ŠIFRA VOKEL	VELIČINA (mm)	ART.
1670057	6	8446
1670019	8	7887
1670006	10	7888
1670009	12	47897
1670011	20	7889
1670012	30	7890
1670013	35	7891
1670014	40	7908
1670015	45	7892
1670016	60	7893
1670064	65	48802
1670058	70	7894
1670018	82	7895
1670005	100	47898
1670008	115	47899



KRUNA ZA PROŠIRENJE

ŠIFRA VOKEL	VELIČINA (mm)	ART.
1670097	20	48773



KRUNA ZA PROŠIRENJE

ŠIFRA VOKEL	VELIČINA (mm)	ART.
1670099	2-38	48774



VOSAK ZA DIJAMANTNE KRUNE

ŠIFRA VOKEL	VELIČINA (ml)	ART.
1670067	20	48767

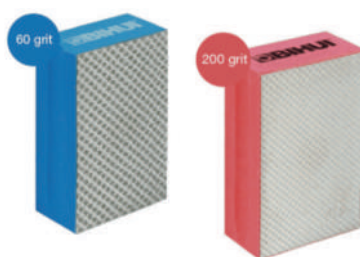

DIJAMANTNA BRUSNA SPUŽVICA

ŠIFRA VOKEL	GRIT (GR)	ART.
1670062	200	48772
1670063	60	48771



VAKUMSKA VODILICA

ŠIFRA VOKEL	PAKIRANJE	ART.
1670023	1	47821



VAKUMSKI NOSAČ - DVOSTRUKI

ŠIFRA VOKEL	PAKIRANJE	ART.
1670024	1	47796



VAKUMSKI NOSAČ - JEDNOSTRUKI

ŠIFRA VOKEL	PAKIRANJE	ART.
1670025	1	47795

VIBRACIJSKI VAKUM ZA PLOČE

ŠIFRA VOKEL	KAPACITET DIZANJA (kg)	ART.
1670084	35	47844

**VAKUMSKI NOSAČ - ZA GRUBE POVRŠINE
SA PUMPOM I REGULACIJOM PRITISKA**

ŠIFRA VOKEL	KAPACITET DIZANJA (kg)	ART.
1670093	110	48028

**VAKUMSKI NOSAČ
MEHANIČKA I ELEKTRIČNA PUMPICA**

ŠIFRA VOKEL	KAPACITET DIZANJA (kg)	ART.
1670126	110 - 140	26339

KUTNI VAKUMSKI REGULATOR RAZMAKA PLOČICA

ŠIFRA VOKEL	DIMENZIJA VAKUMA (")	ART.
1670111	6"	21221

PODESIVI REGULATOR VISINE

ŠIFRA VOKEL	MAX. NOSIVOST (kg)	ART.
1670053	105	47819



ŠABLON VIŠENAMJENSKI

ŠIFRA VOKEL	ART.
1670065	47849



ŠABLON ZA POZICIONIRANJE RUPA

ŠIFRA VOKEL	ART.
1670066	48768



SET GLETERA

ŠIFRA VOKEL	KOM/SET	ART.
1670021	8	47823



IZMJENJIVA DRŠKA ZA SET GLETERA

ŠIFRA VOKEL	ART.
1670104	48027



GLETER NAZUBLJENI ROSTFREI

ŠIFRA VOKEL	VELIČINA (mm)	ART.
1670036	280x130x6	4819
1670034	280x130x8	22611
1670033	280x130x10	22612
1670037	280x130x12	22622



IZMJENJIVA OŠTRICA ZA IZMJENJIVU DRŠKU

ŠIFRA VOKEL	VELIČINA (mm)	ART.
1670105	280x115x4	48793
1670106	280x115x10	20883
1670107	280x115x12	48794

GLETER NAZUBLJENI ROSTFREI

ŠIFRA VOKEL	VELIČINA (mm)	ART.
1670035	480x130x10	4823

GLETER NAZUBLJENI

ŠIFRA VOKEL	VELIČINA (mm)	ART.
1670074	280x120x10	48783
1670075	280x120x12	48784

GLETER RAVNI

ŠIFRA VOKEL	VELIČINA (mm)	ART.
1670100	280x120	48813

GLETER NAZUBLJENI

ŠIFRA VOKEL	VELIČINA (mm)	ART.
1670076	320x120x10	48785
1670077	320x120x12	48786

GLETER ZA FUGIRANJE

ŠIFRA VOKEL	VELIČINA (mm)	ART.
1670086	95x240	39336

ŠIPKA ZA MJEŠANJE - SDS PRIHVAT

ŠIFRA VOKEL	VELIČINA (mm)	ART.
1670043	100x600	37889
1670044	80x400	37888

ŠIPKA ZA MJEŠANJE S NAVOJEM

ŠIFRA VOKEL	VELIČINA (mm)	ART.
1670061	130 - 600	22476



ŠIPKA ZA MJEŠANJE TWIST

ŠIFRA VOKEŁ	VELIČINA (mm)	ART.
1670082	140 x600	48804



ŽLICA GIPSERSKA

ŠIFRA VOKEŁ	VELIČINA (mm)	ART.
1670051	120	1011



ŽLICA ZIDARSKA

ŠIFRA VOKEŁ	VELIČINA (mm)	ART.
1670052	160	16216



ŽLICA KVADRATNA

ŠIFRA VOKEŁ	VELIČINA (mm)	ART.
1670085	160	48021



ŠPAHTLA - LOPATICA

ŠIFRA VOKEŁ	VELIČINA (mm)	ART.
1670045	50	20767
1670046	75	20768
1670047	100	20769



SET POSUDA - VALJAK + TOČKIĆI

ŠIFRA VOKEŁ	VOLUMEN (l)	ART.
1670039	20	22477

POSUDA ZA FUGIRANJE

ŠIFRA VOKEL	VOLUMEN (l)	ART.
1670080	19	48766

REŠETKA ZA POSUDU ZA FUGIRANJE

ŠIFRA VOKEL	ART.
1670133	39691

VALJCI ZA POSUDU ZA FUGIRANJE - TROSTRUKI

ŠIFRA VOKEL	ART.
1670134	39692

GLETER SPUŽVA - BIJELA 910 S

ŠIFRA VOKEL	VELIČINA (mm)	ART.
1670031	280x140x30	26628

GLETER SPUŽVA - BIJELA 910 ST NAREZANA

ŠIFRA VOKEL	VELIČINA (mm)	ART.
1670032	280x140x30	16109

SPUŽVA

ŠIFRA VOKEL	VELIČINA (mm)	ART.
1670041	130x140x65	2834
1670042	275x140x65	2835



NIVELIR SISTEM

ŠIFRA VOKEL	VELIČINA (mm)	ART.
1670096	12-20	15497.1



BAZA ZA NIVELIRANJE

ŠIFRA VOKEL	VELIČINA (mm)	ART.
1670102	1,5	15502.2
1670103	1	15499.2



LOPATICA ZA SILIKON

ŠIFRA VOKEL	ART.
1670078	48788



STRUGAČ ZA FUGE I ZAMJENSKI NOŽ

ŠIFRA VOKEL	VELIČINA (mm)	ART.
1670081	50	47846
1670083	-	47847



STRUGAČ ZA STAKLO +5 PRIČUVNIH NOŽIĆA

ŠIFRA VOKEL	PAK/KOM	ART.
1670089	6	47725



PRIČUVNI NOŽIĆ

ŠIFRA VOKEL	VELIČINA (mm)	ART.
1670088	18	47580

KLJIJEŠTA ZA NIVELIRANJE

ŠIFRA VOKEL	ART.
1670060	15514

KLJIJEŠTA ZA PORCULANSKE PLOČE

ŠIFRA VOKEL	ART.
1670092	48026

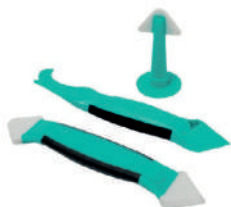
SET ZA RAD SA SILIKONIMA

ŠIFRA VOKEL	PAK/KOM	ART.
1670022	3	47848

GUMENI ČEKIĆ

ŠIFRA VOKEL	VELIČINA (mm)	ART.
1670027	55	4968
1670028	75	4969

PIŠTOLJ ALUMINIJSKI ZA MASE

ŠIFRA VOKEL	KAPACITET (ml)	ART.
1670087	320	1221

PIŠTOLJ ZA PUR PJENU

ŠIFRA VOKEL	SNAGA (kg)	ART.
1670113	9	28112



PIŠTOLJ ZA PUR PJENU PTFE

ŠIFRA VOKEL	MATERIJAL	ART.
1670114	TEFLON	11659



ŠTITNICI ZA KOLJENA

ŠIFRA VOKEL	VELIČINA (mm)	ART.
1670048	150x150x20	271
1670049	150x170x20	34895



TULJAK ZA FUGIRANJE

ŠIFRA VOKEL	ART.
1670050	14428



KAJLA - VELIKA/MALA

ŠIFRA VOKEL	PAKIRANJE (kom)	ART.
1670069	100	9744
1670070	50	12106



SKALPEL S METALNOM VODILICOM

ŠIFRA VOKEL	VELIČINA (mm)	ART.
1670040	max 18	290



PRIČUVNI NOŽIĆ ZA SKALPEL

ŠIFRA VOKEL	VELIČINA (mm)	ART.
1670038	18	294



SKALPEL SILVER PROFY

ŠIFRA VOKEL	VELIČINA (mm)	ART.
1670072	18	20460



LIBELA PT

ŠIFRA VOKEL	VELIČINA (mm)	ART.
1670055	200	33114



LIBELA PTM 5 - MAGNETNA

ŠIFRA VOKEL	VELIČINA (mm)	ART.
1670056	200	33115



DRVENI DVOMETAR

ŠIFRA VOKEL	VELIČINA (mm)	ART.
1670068	2000	16594



ROLNI METAR

ŠIFRA VOKEL	VELIČINA (mm)	ART.
1670109	5000x25	47885



KUTNIK

ŠIFRA VOKEL	VELIČINA (mm)	ART.
1670090	350	5018



ALUMINIJSKI KUTNIK

ŠIFRA VOKEL	VELIČINA (mm)	ART.
1670110	500	47658



OLOVKA ZA SJAJNE POVRŠINE

ŠIFRA VOKEL	ART.
1670071	16630



TERSARSKI MARKER

ŠIFRA VOKEL	ART.
1670073	47878



KREP TRAKA - PAPIRNATA

ŠIFRA VOKEL	VELIČINA (mm)	ART.
1670094	30-50	34887
1670095	50-50	34889



TCM7 - OLOVKA ZA OZNAČAVANJE

ŠIFRA VOKEL	PAKIRANJE (kom)	ART.
1670112	6	53070



ULOŽAK OLOVKE ZA OZNAČAVANJE TCM7-SL

ŠIFRA VOKEL	PAKIRANJE (kom)	ART.
1670120	6	319



CLM30 - UŽE ZA POVLAČENJE LINIJA

ŠIFRA VOKEL	PAKIRANJE (kom)	DUŽINA (m)	ART.
1670123	1	30	38657



PRAH ZA OBILJEŽAVANJE

ŠIFRA VOKEL	PAKIRANJE (kom)	TEŽINA (g)	BOJA	ART.
1670124	1	230	crvena	12155
1670125	1	230	plava	12166



KATALOG PROIZVODA

BUILDING TRUST





Sika® MonoSeal 101 - UNUTARNJA HIDROIZOLACIJA

- » Djelotvorna, ekonomična hidroizolacija postojećih objekata
- » Jednostavna primjena četkom
- » Sprječavanje prodora podzemne vode ili sprječavanje otjecanja stajaće ili tekuće vode u građevinskim hidrotehničkim konstrukcijama
- » Pogodan za hidroizolaciju spremnika pitke vode
- » Potrošnja: približno ~ 1.9 kg/m²/mm

VOKEL ŠIFRA	OPIS	PAKIRANJE (kg)	BOJA	ARTIKAL
1676003	SIKA MONOSEAL-101	20	SIVA	480132

SikaTop® Seal 107 - DVOKOMPONENTNA HIDROIZOLACIJA



- » Visoka vodonepropusnost
- » Unaprijed izmjerene komponente: bez pogrešaka kod mješanja
- » Otpornost na savojna naprezanja, koja nisu predmet pucanja podloge
- » Paropropusan
- » Dobra prionjivost na gotovo sve podloge kao npr. beton, cementni mort, kamen, opeku, željezo...
- » Jednostavna primjena čak i na vertikalnim površinama i stropovima
- » Potrošnja: približno ~ 2.0 kg/m²/mm

VOKEL ŠIFRA	OPIS	PAKIRANJE (kg)	BOJA	ARTIKAL
1676005	SIKATOP®SEAL 107 KOMPONENTA B	20	SIVA	479498
1676004	SIKATOP®SEAL 107 KOMPONENTA A			

Sikalastic® 1K - JEDNOKOMPONENTNA HIDROIZOLACIJA



- » Jednokomponentni proizvod, samo dodati vodu
- » Podesive konzistencije, lako se nanosi četkom ili gleterom
- » Nema klizanja i jednostavna primjena čak i na vertikalne površine
- » Dobra sposobnost premošćivanja pukotina
- » Vrlo dobra prionjivost na razne vrste podloga, uključujući beton, cementne mortove, kamen, opeku
- » Može se nanositi na vlažne podloge
- » Atest za pitku vodu

VOKEL ŠIFRA	OPIS	PAKIRANJE (kg)	BOJA	ARTIKAL
1676002	SIKALASTIC® 1K	20	SIVA	506520

Sikalastic®-220 W - UNUTARNJA HIDROIZOLACIJA



- » Jedna komponenta spremna za upotrebu
- » Bez otapala
- » Vodonepropusno
- » Moguće koristiti za podno grijanje
- » Potrošnja ~ 1.35 kg/m²/mm u dva sloja
- » Za unutrašnju upotrebu

VOKEL ŠIFRA	OPIS	PAKIRANJE (kg)	BOJA	ARTIKAL
1676001	SIKALASTIC®-220 W	7	SIVA	532220

Sika® SealTape S - TRAKA ZA IZOLACIJU



- » Visok elasticitet
- » Vodootporna
- » Kemijski otporna
- » Jednostavna za aplikaciju
- » Radna temperatura: -25 °C do +60 °C
- » Jednostavna primjena čak i na vertikalnim površinama i stropovima

VOKEL ŠIFRA	OPIS	PAKIRANJE (m)	BOJA	ARTIKAL
1676007	SIKA®SEALTAPE S	50	-	123265

Sika® MonoTop-108 - BRZOVEZUJUĆI CEMENT



- » Koristi se za trenutno zaustavljanje prodora vode pod negativnom pritiskom (pukotine, rupe, spojevi)
- » Trenutno brtvljenje ispusta vode za vrijeme hidroizolacijskih radova
- » Brzo otvrdnjavanje (bez ispiranja) čak i pri tekućoj vodi
- » Otvrdnjava unutar 60-80 sekundi (pri +20°C)

VOKEL ŠIFRA	OPIS	PAKIRANJE (kg)	BOJA	ARTIKAL
1676006	MonoTop-108	5	SIVA	533495

Sikaflex®-11 FC+ - MASA ZA BRTVLJENJE I LJEPLJENJE



- » Jednokomponentan, spreman za upotrebu
- » Fleksibilan i trajno elastičan
- » Bez otapala i mirisa
- » Vrlo niska emisija brtvilo: vezanje bez pojave mjehurića
- » Vrlo dobra prionjivost za većinu građevinskih materijala
- » Dobra mehanička otpornost
- » Dobra otpornost na atmosferske promjene i starenje
- » Ne curi / ne propada ljepilo: zaljepljene dijelove ne treba dodatno podlagati
- » Nije korozivan, ublažava udarce i vibracije
- » Dostupan u 5 boja
- » Brtvilo i višenamjensko ljepilo

VOKEL ŠIFRA	OPIS	PAKIRANJE (ml)	BOJA	ARTIKAL
1676012	SIKAFLEX-11	300	SMEĐA	83706
1676013	SIKAFLEX-11	300	CRNA	84387
1676014	SIKAFLEX-11	300	SIVA	83707
1676015	SIKAFLEX-11	300	BIJELA	83708
1676016	SIKAFLEX-11	300	BEŽ	84386

Sika® Sanisil® - SANITARNI SILIKON



- » Dugoročna otpornost na gljivice i lišajeve
- » Odlična UV zaštita i otpornost na atmosferske promjene
- » Bez otapala
- » Visoka elastičnost i fleksibilnost
- » Dostupan u tri boje

VOKEL ŠIFRA	OPIS	PAKIRANJE (ml)	BOJA	ARTIKAL
1676008	SANISIL	300	BIJELA	73999
1676009	SANISIL	300	TRANSPARENTNA	73988
1676010	SANISIL	300	SIVA	72028

Sikacryl®-108 S - AKRILNI SILIKON



- » Dobre mogućnosti nanošenja
- » Ne sadrži rastvarače
- » Bez mirisa
- » Na bazi vode
- » Može se farbati nakon očvršćivanja
- » Dobro prijanja na podloge kao što su drvo, beton itd.
- » Za vanjsku i unutarnju primjenu
- » Visoka postojanost, odlična UV otpornost
- » Otporan na kišu
- » Mogućnost kretanja 15%

VOKEL ŠIFRA	OPIS	PAKIRANJE (ml)	BOJA	ARTIKAL
1676011	SIKACRYL-108 S BIJELI	310	BIJELA	579705

SikaBond® AT Universal - UNIVERZALNI SILIKON



- » Jednokomponentno, spremno za upotrebu
- » Visoka čvrstoća ljepljenja na različite podloge bez upotrebe primera
- » Odlična ugradivost
- » Kratka nit odvajanja od pakiranja prilikom ugradnje
- » Dobra početna čvrstoća i brzo otvrdnjavanje
- » Mogućnost kompeziranja neravnina na podlozi
- » Ne izaziva koroziju
- » Izvrsna otpornost na atmosferske promjene i vodu
- » Bez silikona
- » Može se prebojavati
- » Bez otapala
- » Dostupan u dvije boje: sivo i bijelo

VOKEL ŠIFRA	OPIS	PAKIRANJE (ml)	BOJA	ARTIKAL
1676019	SIKABOND-AT UNIVERSAL	300	SIVA	526922

Sikaflex®-112 Crystal Clear - BEZBOJNO LJEPILO



- » Jednokomponentan, spreman za upotrebu, ljepilo i masa za brtvljenje
- » 100% transparentan
- » Dobro incijalno vezivanje
- » Veoma niska emisija isparavanja
- » Ljepilo-masa za brtvljenje sa CE certifikatom
- » Za unutarnju i vanjsku upotrebu

VOKEL ŠIFRA	OPIS	PAKIRANJE (ml)	BOJA	ARTIKAL
1676018	SIKAFLEX® -112 CRYSTAL CLEAR	290	PROZIRAN	581467

Sika AnchorFix®-1 Crystal Clear - INEKCIONI MORT



- » Brzo vezanje
- » Korištenje standardnog pistolja
- » Aplikacija na niskim temperaturama
- » Velika nosivost
- » ETA odobrenje za sidrenje u betonu bez pukotina
- » ETA odobrenje za sidrenje u čvrstim i šupljim zidovima
- » Bez curenja
- » Slabog mirisa
- » Malo otpada

VOKEL ŠIFRA	OPIS	PAKIRANJE (ml)	BOJA	ARTIKAL
1676017	ANCHORFIX®-1	300	PROZIRAN	581467

GARANCIJA
2
GODINE



ARCEUS

E.C.A.[®]

TOGETHER FOR YEARS

348

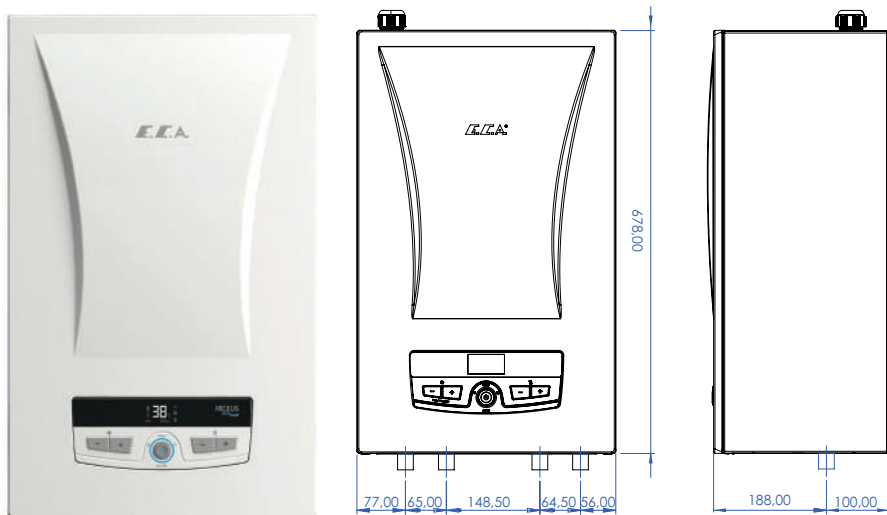

OPIS PROIZVODA

E.C.A ARCEUS je linija termo blokova koja se sastoji od dva tipa. Tip CH koji se koristi za centralno grijanje, te tip MT koji podržava centralno grijanje i sanitarnu toplu vodu.

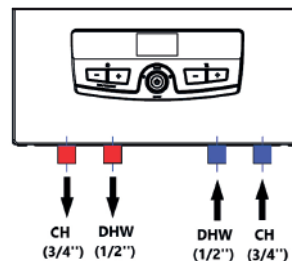

MT TIP

Monotermički tip termo bloka funkcionira na način da zagrijava vodu za centralno grijanje, te istovremeno funkcionira kao protočni bojler za sanitarnu toplu vodu. Ovaj tip termo bloka u sebi ima dva kruga grijanja; jedan za grijanje prostora (CH), a drugi za sanitarnu toplu vodu (DHW). Može se koristiti za radijatorsko ili podno grijanje.

CH TIP

Uređaji tipa CH (centralno grijanje) provode grijanje vode na istom principu kao MT uređaji. Razlika između njih je u tome što CH uređaji ne mogu osigurati grijanje sanitarne vode.

Komponente termo bloka

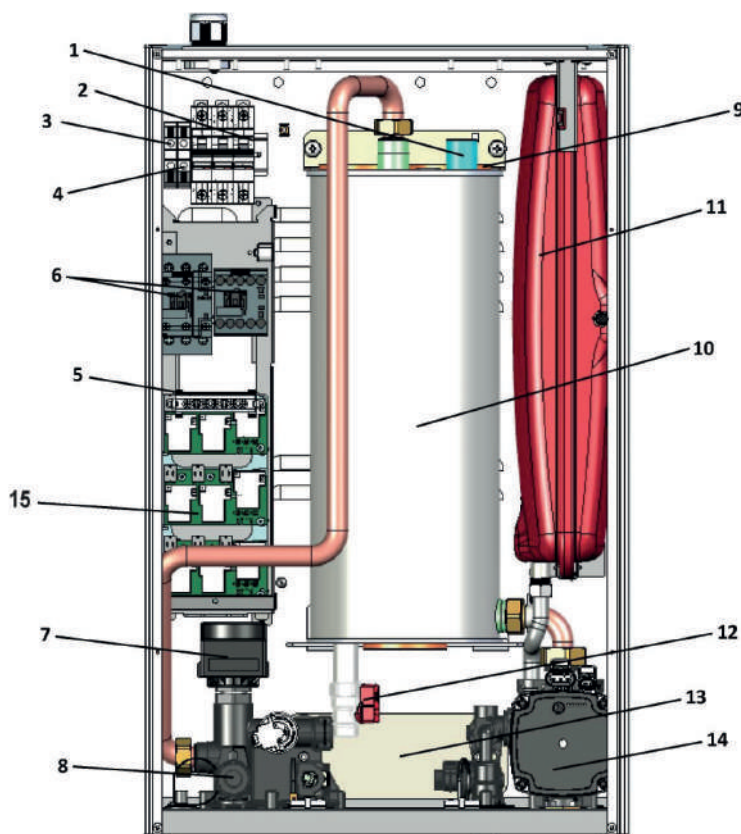

1. Ozraka
2. Osigurači
3. Stezaljka - uzemljenje
4. Stezaljka - neutralna
5. Neutralni sabirnik
6. Sklopnici
7. Troputni ventil
8. Sigurnosni ventil (3 bar)
9. Električni grijači
10. Glavni izmjenjivač topline
11. Ekspanzijska posuda
12. Ispusni ventil
13. Pločasti izmjenjivač (kod MT tipa)
14. Cirkulacijska pumpa (GRUNDFOSS UPM4 15-60)
15. Relejne ploče

TABLICA TEHNIČKIH PODATAKA

(CH-centralno grijanje; DHW-sanitarna topla voda)

Tip uređaja	Mjerna jedinica	ARCEUS EK 6	ARCEUS EK 9	ARCEUS EK 12	ARCEUS EK 15	ARCEUS EK 18	ARCEUS EK 24	ARCEUS EK 27	
Nominalna snaga	kW	6	9	12	15	18	24	27	
Minimalna snaga grijanja	kW	2	3	2	2	2	2	3	
Broj grijača	6	kW	1	-	2	1	3	1	-
	9	kW	-	1	-	1	-	2	3
Raspon grijanja	°C	30-80							
DHW raspon temperature	°C	-	-	30-65					
DHW maksimalna temperatura	°C	-	-	65	65	65	65	65	
DHW maksimalni protok	l/min	-	-	7	8	9	10	10	
ΔT pri maksimalnom protoku	°C	-	-	24,6	26,9	28,7	34,4	38,7	
Napon napajanja	faza/V	1/230	1/230	1/230	3/400	3/400	3/400	3/400	
		3/400	3/400	3/400					
Nazivna struja	faza/A	1/26,1	1/39,1	1/52,2	3/21,7	3/26,1	3/34,8	3/39,1	
		3/8,7	3/13,1	3/17,4					
Presjek napojnog kabela	mm ²	1/3x6	1/3x10	1/3x10	5x6	5x6	5x6	5x10	
		3/5x2,5	3/5x2,5	3/5x4					
Klasa zaštite	-	IPX4D	IPX4D	IPX4D	IPX4D	IPX4D	IPX4D	IPX4D	
Razina zvuka	dB	42	42	38	38	38	38	38	
Neto težina	kg	26	26	27	27	29	29	29	
Bruto težina	kg	29	29	30	30	32	32	32	
Dimenzije (VxŠxD)	mm	678x410x288							
Klasa energetske učinkovitosti	C H	-	D	D	D	D	D	D	
	D H W	-	-	C	C	C	C	C	

ŠIFRA VOKEL	NAZIV	ARTIKAL
1478001	Elektro kotao EK CH 6	8396255010
1478002	Elektro kotao EK CH 9	8396256010
1478003	Elektro kotao EK CH 12	8396257010
1478004	Elektro kotao EK CH 15	8396258010
1478005	Elektro kotao EK CH 18	8396259010
1478006	Elektro kotao EK CH 24	8396260010
1478007	Elektro kotao EK CH 27	8396261010
1478008	Elektro kotao EK MT 18	8396252010

MAGIS

VISEĆA WC ŠKOLJKA



ŠIFRA VOKEL	OPIS	BOJA	ARTIKAL
1727001	WC ŠKOLJKA RIMLESSS	BIJELA	2731
1727002	HIGIJENSKA WC ŠKOLJKA RIMLESSS	BIJELA	2730

WC DASKA KOJU PREPORUČUJEMO

VOKEL ŠIFRA	OPIS	ARTIKAL
0479030	RAY SOFTCLOSE	531784

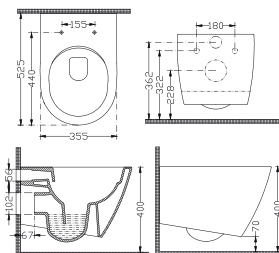

MAGIS

HIGIJENSKA VIŠEĆA WC ŠKOLJKA



ŠIFRA VOKEL	OPIS	BOJA	ARTIKAL
1727003	RIMLESS S UGRAĐENIM VENILOM	BIJELA	2733

WC DASKA KOJU PREPORUČUJEMO

VOKEL ŠIFRA	OPIS	ARTIKAL
0479030	RAY SOFTCLOSE	531784

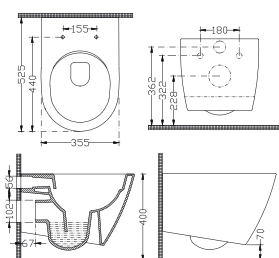

MAGIS

VIŠEĆI BIDE

ŠIFRA VOKEL	OPIS	BOJA	ARTIKAL
1727008	VIŠEĆI BIDE MAGIS	BIJELA	2735

VELA

VIŠEĆA WC ŠKOLJKA



ŠIFRA VOKEL	OPIS	BOJA	ARTIKAL
1727004	WC ŠKOLJKA RIMLESSS	BIJELA	2631
1727005	HIGIJENSKA WC ŠKOLJKA RIMLESSS	BIJELA	2630

WC DASKA KOJU PREPORUČUJEMO

VOKEL ŠIFRA	OPIS	ARTIKAL
0479028	RAY SOFTCLOSE	536117

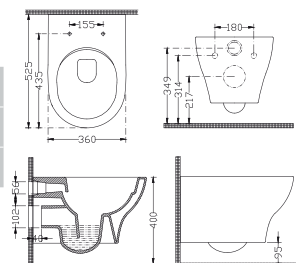



VELA

VIŠEĆI BIDE

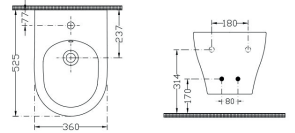

ŠIFRA VOKEL	OPIS	BOJA	ARTIKAL
1727009	VIŠEĆI BIDE VELA	BIJELA	2635

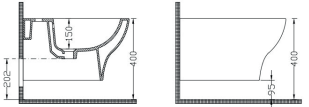

NORMA

VIŠEĆA WC ŠKOLJKA



ŠIFRA VOKEL	OPIS	BOJA	ARTIKAL
1727007	WC ŠKOLJKA	BIJELA	1535 K
1727006	HIGIJENSKA WC ŠKOLJKA	BIJELA	1534 K

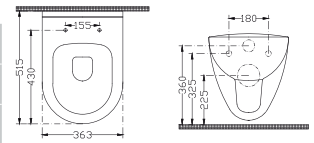

WC DASKA KOJU PREPORUČUJEMO

VOKEL ŠIFRA	OPIS	ARTIKAL
0479027	RAY SOFTCLOSE	531339

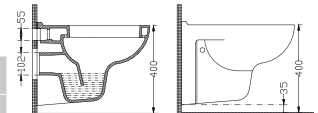



BATERIJA ZA UMIVAONIK

ESSENCE CRNA MAT

ŠIFRA VOKEL	BOJA	ŠIFRA ARTIKLA	PAKIRANJE
0437366	CRNA	24172KF1	1

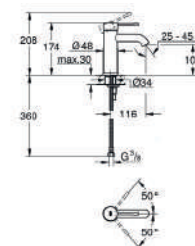

BATERIJA ZA UMIVAONIK

ESSENCE CRNA MAT

ŠIFRA VOKEL	BOJA	ŠIFRA ARTIKLA	PAKIRANJE
0437370	CRNA	24176KF1	1

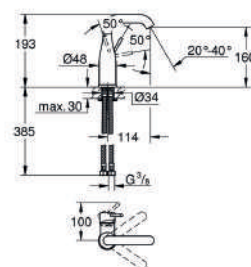

BATERIJA ZA UMIVAONIK

ESSENCE CRNA MAT - XL

ŠIFRA VOKEL	BOJA	ŠIFRA ARTIKLA	PAKIRANJE
0437381	CRNA	24177KF1	1

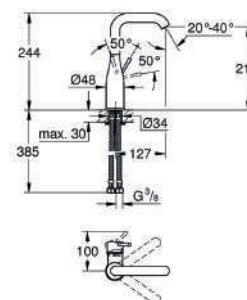

BATERIJA ZA UMIVAONIK

ESSENCE CRNA MAT - VISOKA

ŠIFRA VOKEL	BOJA	ŠIFRA ARTIKLA	PAKIRANJE
0437371	CRNA	24170KF1	1

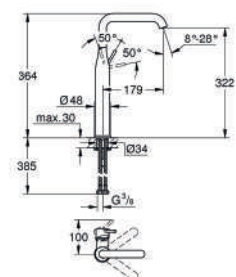

BATERIJA ZA UMIVAONIK

ESSENCE CRNA MAT - PODŽBUKNA

ŠIFRA VOKEL	BOJA	ŠIFRA ARTIKLA	PAKIRANJE
0437372	CRNA	29192KF1	1
NAPOMENA: UZ BATERIJU POTREBAN PODŽBUKNI MEHANIZAM			
0437319	/	23571000	1

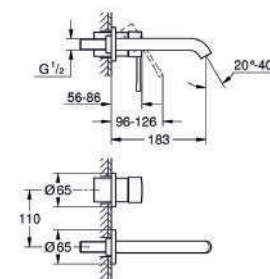



BATERIJA ZA BIDE

ESSENCE CRNA MAT

ŠIFRA VOKEL	BOJA	ŠIFRA ARTIKLA	PAKIRANJE
0437373	CRNA	24395KF1	1

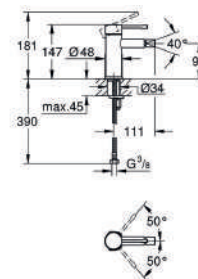

BATERIJA ZA TUŠ

ESSENCE CRNA MAT

ŠIFRA VOKEL	BOJA	ŠIFRA ARTIKLA	PAKIRANJE
0437374	CRNA	25252KF1	1

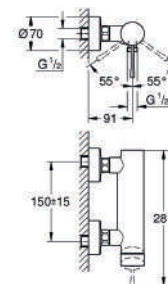

BATERIJA ZA KADU

ESSENCE CRNA MAT

ŠIFRA VOKEL	BOJA	ŠIFRA ARTIKLA	PAKIRANJE
0437375	CRNA	25250KF1	1

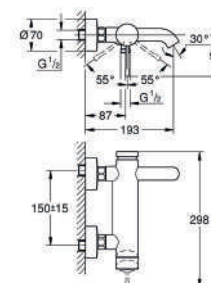

BATERIJA ZA KADU

PODŽBUKNA ESSENCE CRNA MAT

ŠIFRA VOKEL	BOJA	ŠIFRA ARTIKLA	PAKIRANJE
0437376	CRNA	24167KF1	1
NAPOMENA: UZ BATERIJU POTREBAN PODŽBUKNI MEHANIZAM			
0437254	/	35600000	1

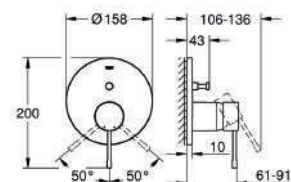

BATERIJA ZA KADU - SMARTCONTROL

PODŽBUKNA TERMOSTATSKA BATERIJA S 2 VENTILA

ŠIFRA VOKEL	BOJA	ŠIFRA ARTIKLA	PAKIRANJE
0437378	CRNA	29507KF0	1
NAPOMENA: UZ BATERIJU POTREBAN PODŽBUKNI MEHANIZAM			
0437254	/	35600000	1

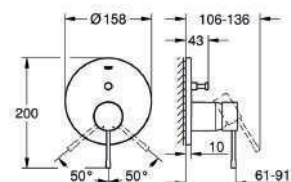

RAINSHOWER COSMOPOLITAN

CRNI MAT - SA TUŠ GLAVOM FI 310

ŠIFRA VOKEL	BOJA	ŠIFRA ARTIKLA	PAKIRANJE
0437377	CRNA	22121KF0	1

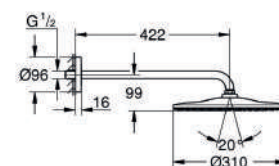



KOLJENO ZA TUŠ CRIJEVO

CRNO MAT

ŠIFRA VOKEL	BOJA	ŠIFRA ARTIKLA	PAKIRANJE
0437384	CRNA	22118KF0	1

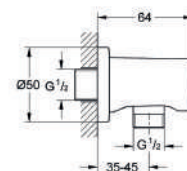

DRŽAČ TUŠ RUČICE

RAINSHOWER CRNI MAT

ŠIFRA VOKEL	BOJA	ŠIFRA ARTIKLA	PAKIRANJE
0437383	CRNA	22117KF0	1

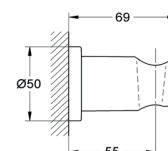

RAINSHOWER SMARTACTIVE 130

TUŠ RUČICA - CRNA MAT

ŠIFRA VOKEL	BOJA	ŠIFRA ARTIKLA	PAKIRANJE
0437382	SUNRISE	22127KF0	1

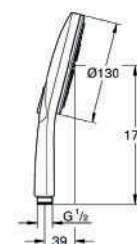

EUPHORIA

TUŠ RUČICA - CRNA

ŠIFRA VOKEL	BOJA	ŠIFRA ARTIKLA	PAKIRANJE
0437386	CRNA	22126KF0	1

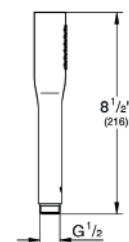

CRIJEVO ZA TUŠ

125 cm - CRNO MAT

ŠIFRA VOKEL	BOJA	ŠIFRA ARTIKLA	PAKIRANJE
0437385	CRNA	28362KF1	1



RAINSHOWER SMARTACTIV

900 mm - CRNO MAT

ŠIFRA VOKEL	BOJA	ŠIFRA ARTIKLA	PAKIRANJE
0437380	CRNA	22125KF0	1

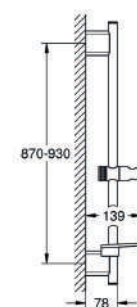



ESSENCE

CRNA MAT

ŠIFRA VOKEL	BOJA	ŠIFRA ARTIKLA	PAKIRANJE
0437379	CRNA MAT	30504KF0	1

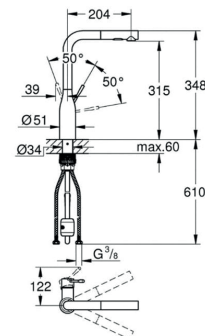

EUROSMART

VISOKI IZLJEV

ŠIFRA VOKEL	BOJA	ŠIFRA ARTIKLA	PAKIRANJE
0437413	CRNA	332022433	1

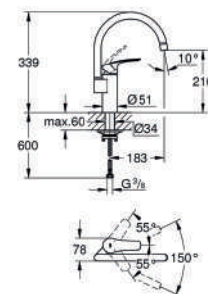



BATERIJA ZA UMIVAONIK

EUROSMART CRNA MAT

ŠIFRA VOKEL	BOJA	ŠIFRA ARTIKLA	PAKIRANJE
0437400	CRNA	332652433	1

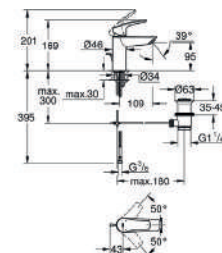

BATERIJA ZA UMIVAONIK

EUROSMART CRNA MAT - XL

ŠIFRA VOKEL	BOJA	ŠIFRA ARTIKLA	PAKIRANJE
0437402	CRNA	233222433	1

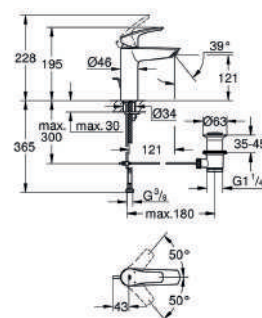

BATERIJA ZA UMIVAONIK

ESUROSMART CRNA MAT - VISOKA

ŠIFRA VOKEL	BOJA	ŠIFRA ARTIKLA	PAKIRANJE
0437401	CRNA	239712433	1

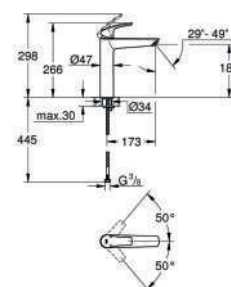

BATERIJA ZA UMIVAONIK

EUROSMART CRNA MAT - PODŽBUKNA

ŠIFRA VOKEL	BOJA	ŠIFRA ARTIKLA	PAKIRANJE
0437407	CRNA	293382433	1
NAPOMENA: UZ BATERIJU POTREBAN PODŽBUKNI MEHANIZAM			
0437319	/	23571000	1

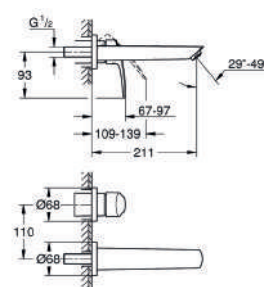

BATERIJA ZA BIDE

EUROSMART CRNA MAT

ŠIFRA VOKEL	BOJA	ŠIFRA ARTIKLA	PAKIRANJE
0437403	CRNA	329292433	1

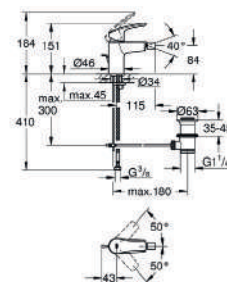



BATERIJA ZA TUŠ

EUROSMART CRNA MAT

ŠIFRA VOKEL	BOJA	ŠIFRA ARTIKLA	PAKIRANJE
0437399	CRNA	335552433	1

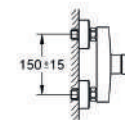
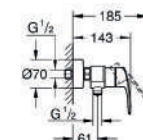

BATERIJA ZA KADU

EUROSMART CRNA MAT

ŠIFRA VOKEL	BOJA	ŠIFRA ARTIKLA	PAKIRANJE
0437398	CRNA	333002433	1

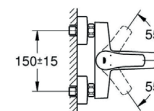
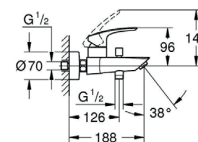

BATERIJA ZA KADU

PODŽBUKNA EUROSMART CRNA MAT

ŠIFRA VOKEL	BOJA	ŠIFRA ARTIKLA	PAKIRANJE
0437405	CRNA	194502433	1

NAPOMENA: UZ BATERIJU POTREBAN PODŽBUKNI MEHANIZAM

0437404	/	33963000	1
----------------	---	----------	---

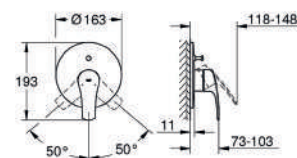

BATERIJA ZA TUŠ

PODŽBUKNA EUROSMART CRNA MAT

ŠIFRA VOKEL	BOJA	ŠIFRA ARTIKLA	PAKIRANJE
0437406	CRNA	194512433	1

NAPOMENA: UZ BATERIJU POTREBAN PODŽBUKNI MEHANIZAM

0437404	/	33963000	1
----------------	---	----------	---

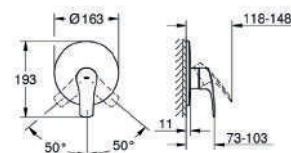

PODŽBUKNI MEHANIZAM

ZA KADU I TUŠ

ŠIFRA VOKEL	BOJA	ŠIFRA ARTIKLA	PAKIRANJE
0437404	CRNA	33963000	1

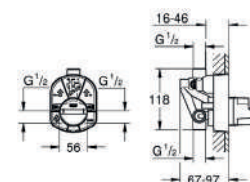

TUŠ GLAVA TEMPESTA 250

CRNA MAT - S IZLJEVOM 380mm

ŠIFRA VOKEL	BOJA	ŠIFRA ARTIKLA	PAKIRANJE
0437410	CRNA	266682430	1

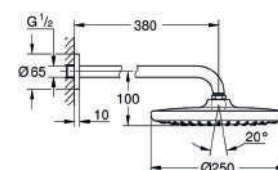



TEMPESTA

TUŠ RUČICA - CRNA MAT

ŠIFRA VOKEL	BOJA	ŠIFRA ARTIKLA	PAKIRANJE
0437408	CRNA	261612433	1

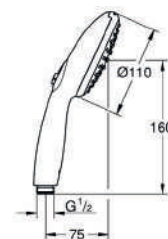

TEMPESTA

TUŠ SET PODŽBUKNA INSTALACIJA - CRNA MAT

ŠIFRA VOKEL	BOJA	ŠIFRA ARTIKLA	PAKIRANJE
0437409	CRNA	264062433	1

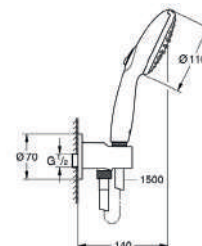

TEMPESTA

TUŠ SET S ZIDNIM DRŽAČEM - CRNA MAT

ŠIFRA VOKEL	BOJA	ŠIFRA ARTIKLA	PAKIRANJE
0437412	CRNA	1025302431	1

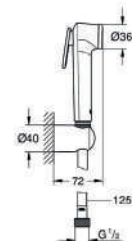

TEMPESTA 110

TUŠ SET S KONZOLOM CRIJEVOM I TUŠ RUČICOM - CRNA MAT

ŠIFRA VOKEL	BOJA	ŠIFRA ARTIKLA	PAKIRANJE
0437411	CRNA	261622433	1

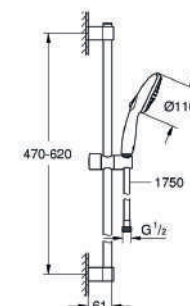

TEMPESTA 250

TUŠ SUSTAV S TERMOSTATSKOM BATERIJOM - CRNA MAT

ŠIFRA VOKEL	BOJA	ŠIFRA ARTIKLA	PAKIRANJE
0437396	CRNA	266702431	1

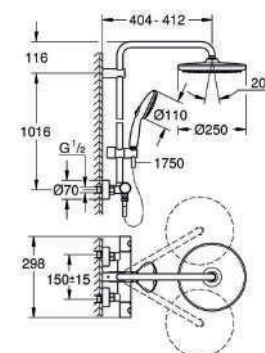



POWER 5

ALAT ZA REZANJE KERAMIKE

VOKEL ŠIFRA	DIMENZIJA (cm)	ARTIKAL
1367107	63x63	63P5
1367108	75x75	75P5
1367109	93x93	93P5
1367110	131x131	131P5
1367111	161x161	161P5



EVOLUTION 3

ALAT ZA REZANJE KERAMIKE

VOKEL ŠIFRA	DIMENZIJA FORMATA (cm)	ARTIKAL
1367041	52x52	52P3



EVO2

ALAT ZA REZANJE KERAMIKE

VOKEL ŠIFRA	DIMENZIJA DEBLJINE DO (mm)	ARTIKAL
1367087	35	905EVO2



FL3

SET ZA REZANJE VELIKIH FORMATA

VOKEL ŠIFRA	DIMENZIJA FORMATA (cm)	ARTIKAL
1367103	0-340	FL3



F1

ELEKTRIČNA REZALICA KERAMIKE

VOKEL ŠIFRA	DIMENZIJA (DxŠxV)	ARTIKAL
1367045	146x68x124	F1-101



BATTLE

VIBRACIJSKI VAKUM PODIZAČ

VOKEL ŠIFRA	ARTIKAL
1367083	BATTLE



300-71SL2PZ

VAKUM PODIZAČ KOMPLET 2 kom

VOKEL ŠIFRA	ARTIKAL
1367093	300-71SL2PZ



300-76

VAKUM PODIZAČ ZA VELIKE FORMATE

VOKEL ŠIFRA	ARTIKAL
1367076	300-76



300-71

VAKUM PODIZAČ ZA VELIKE FORMATE

VOKEL ŠIFRA	ARTIKAL
1367061	300-71



16-S

RUČKA ZA PODIZANJE I PRIJENOS PLOČICA

VOKEL ŠIFRA	ARTIKAL
1367095	16-S



300-80L

SET ZA DIZANJE VELIKIH FORMATA

VOKEL ŠIFRA	ARTIKAL
1367097	300-80L



300-70SL

SET ZA DIZANJE VELIKIH FORMATA S TOČKIĆIMA

VOKEL ŠIFRA	ARTIKAL
1367098	300-70SL



TOPROFILE

ELEKTRIČNI UREĐAJ ZA PROFILIRANJE

VOKEL ŠIFRA	ARTIKAL
1367084	TOPROFILE



TUTORCUT

VODILICA ZA PRECIZNO REZANJE

VOKEL ŠIFRA	ARTIKAL
1367091	TUTORCUT115-U



300-20

RADNI STOL ZA KERAMIČARE

VOKEL ŠIFRA	ARTIKAL
1367080	300-20



VERTIGO

STALAK ZA REZALICU

VOKEL ŠIFRA	ARTIKAL
1367060	VERTIGO2

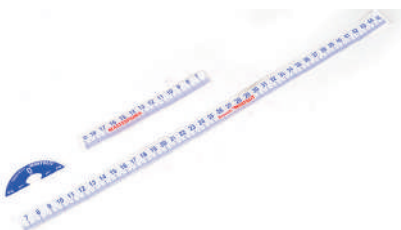

481P2

MJERNA TRAKA ZA REZALICU

VOKEL ŠIFRA	ARTIKAL
1367077	481P2



X-WORKS

RADNI STOL ZA KERAMIČARE

VOKEL ŠIFRA	ARTIKAL
1367046	X-WORKS



MOSAKIT

PODLOGA ZA REZANJE MOZAIKA

VOKEL ŠIFRA	ARTIKAL
1367006	58



BASEBOARD

GRANIČNIK PRI REZANJU KERAMIKE

VOKEL ŠIFRA	ARTIKAL
1367043	64



P5

NOSAČ REZNOG KOLA

VOKEL ŠIFRA	DIMENZIJA (mm)	ARTIKAL
1367112	7	505P5
1367113	12	506P5



P5

NOSAČ REZNOG KOLA

VOKEL ŠIFRA	DIMENZIJA (mm)	ARTIKAL
1367038	7	505
1367037	12	506

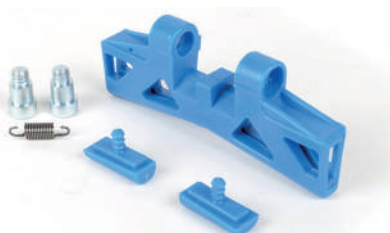

446P

STOPICA ZA REZANJE LKERAMIKE

VOKEL ŠIFRA	ARTIKAL
1367036	446P



515-5

AMPULE ZA PODMAZIVANJE

VOKEL ŠIFRA	PAKIRANJE (kom)	ARTIKAL
1367039	5	515-5



T

REZNO KOLO ZA REZANJE KERAMIKE

VOKEL ŠIFRA	ARTIKAL
1367070	240T
1367063	241T
1367007	243
1367008	243T



55W2

SPECIAL KLIJEŠTA ZA KERAMIKU

VOKEL ŠIFRA	ARTIKAL
1367010	55W2



33W

KLIJEŠTA ZA KERAMIKU

VOKEL ŠIFRA	ARTIKAL
1367088	33W



56R

KLIJEŠTA ZA LOMLJENJE KERAMIKE Max 20 mm

VOKEL ŠIFRA	ARTIKAL
1367082	56R



449P

PRODUŽENA NOGICA ZA LOM KERAMIKE

VOKEL ŠIFRA	ARTIKAL
1367071	449P



MFL2

ELEKTERIČNA REZALICA KERAMIKE

VOKEL ŠIFRA	ARTIKAL
1367081	MFL2-PU



CZ

REZNA PLATA

VOKEL ŠIFRA	DIMENZIJA (Ø mm)	ARTIKAL
1367011	100	CZ115



CSE

REZNA PLATA

VOKEL ŠIFRA	DIMENZIJA (Ø mm)	ARTIKAL
1367012	115	CSE115



CG

REZNA PLATA

VOKEL ŠIFRA	DIMENZIJA (Ø mm)	ARTIKAL
1367014	115	CG115



CPF

REZNA PLATA

VOKEL ŠIFRA	DIMENZIJA (Ø mm)	ARTIKAL
1367065	200	CPF200



TCS

REZNA PLATA

VOKEL ŠIFRA	DIMENZIJA (Ø mm)	ARTIKAL
1367015	85	TCS85



SCX

REZNA PLATA

VOKEL ŠIFRA	DIMENZIJA (Ø mm)	ARTIKAL
1367027	250	SCX250
1367017	350	SCX350



CX

REZNA PLATA

VOKEL ŠIFRA	DIMENZIJA (Ø mm)	ARTIKAL
1367047	250	CX250



CBX

REZNA PLATA

VOKEL ŠIFRA	DIMENZIJA (Ø mm)	ARTIKAL
1367049	115	CBX115



TXH

REZNA PLATA

VOKEL ŠIFRA	DIMENZIJA (Ø mm)	ARTIKAL
1367050	115	TXH115



CM MOSAIC

REZNA PLATA ZA MOZAIK

VOKEL ŠIFRA	DIMENZIJA (Ø mm)	ARTIKAL
1367051	115	CM115



CGX

REZNA PLATA TURMONT

VOKEL ŠIFRA	DIMENZIJA (Ø mm)	ARTIKAL
1367078	115	CGX115



TCS-R

REZNA PLATA TURMONT

VOKEL ŠIFRA	DIMENZIJA (Ø mm)	ARTIKAL
1367052	115	TCS115R



STL-GF-M

PLATA ZA REZANJE I POLIRANJE - SITNA ZRNCA

VOKEL ŠIFRA	DIMENZIJA (Ø mm)	ARTIKAL
1367073	115	STL115GF-M
1367057	125	STL125GF-M



STIL-GG

DISK ZA POLIRANJE I REZANJE - KRUPNA ZRNCA

VOKEL ŠIFRA	DIMENZIJA (Ø mm)	ARTIKAL
1367074	115	STL115GG



PEBS-GF

DISK ZA BRUŠENJE

VOKEL ŠIFRA	DIMENZIJA (Ø mm)	ARTIKAL
1367072	115	PEBS115GF



FAJ

SVRDLO S DIJAMANTOM ZA BUŠENJE

VOKEL ŠIFRA	DIMENZIJA (Ø mm)	ARTIKAL
1367018	6	FAJ06
1367019	8	FAJ08
1367020	10	FAJ10
1367021	12	FAJ12



FAJVA-N

SET DIJAMANTNA SVRDLA

VOKEL ŠIFRA	ARTIKAL
1367089	FAJVA-N



FAJVA-N
SET ZA BUŠENJE

VOKEL ŠIFRA	DIMENZIJA (Ø mm)	ARTIKAL
1367022	5/6/7/8/10/12	FAJVA-N
1367053	5/6/7/8/10/12 (za suho bušenje)	FAJVA-N



FSB KIT
SET ZA BUŠENJE

VOKEL ŠIFRA	DIMENZIJA (Ø mm)	ARTIKAL
1367032	6/8/10	FSBKIT



FT
SET ZA BUŠENJE

VOKEL ŠIFRA	DIMENZIJA (Ø mm)	ARTIKAL
1367067	20	FT20
1367023	35	FT35
1367031	40	FT40
1367024	60	FT60



FS
SET ZA BUŠENJE

VOKEL ŠIFRA	DIMENZIJA (Ø mm)	ARTIKAL
1367090	10	FS10
1367025	35	FS35
1367028	60	FS60
1367069	68	FS68



FA
DIJAMANTNA KRUNA ZA BUŠENJE

VOKEL ŠIFRA	DIMENZIJA (Ø mm)	ARTIKAL
1367104	40	FA40
1367105	65	FA65



FT-S

DIJAMANTNA KRUNA ZA BUŠENJE

VOKEL ŠIFRA	DIMENZIJA (Ø mm)	ARTIKAL
1367054	35	FT-S35
1367092	40	FT-S40



FPU

DIJAMANTNA KRUNA ZA BUŠENJE

VOKEL ŠIFRA	DIMENZIJA (Ø mm)	ARTIKAL
1367056	20	FPU20



FPS

SVRDLO ZA PROŠIRIVANJE RUPA

VOKEL ŠIFRA	DIMENZIJA (Ø mm)	ARTIKAL
1367079	35-75	FPS75



FPB

ALAT ZA SKIDANJE RUBOVA

VOKEL ŠIFRA	DIMENZIJA (mm)	ARTIKAL
1367033	10	FPB10



FPB

DIJAMANTNI PROFILER

VOKEL ŠIFRA	ARTIKAL
1367099	FPB03TP
1367100	FPB05TP
1367101	FPB10TP



FPE

DIJAMANTNI PROFILER

VOKEL ŠIFRA	ARTIKAL
1367085	FPE15TPGF



FPE
DIJAMANTNI PROFILER

VOKEL ŠIFRA	ARTIKAL
1367102	FPE15TP



AUFA
SPOJNICA ZA DIJAMANTNE KRUNE

VOKEL ŠIFRA	ARTIKAL
1367106	AUFA



300-VAS
DIJAMANTNI SET ZA TANKE PLOČICE

VOKEL ŠIFRA	ARTIKAL
1367086	300-VAS



M-PERFORMER
RASHLADNA TEKUĆINA ZA DIJAMANTNO SVRDLO

VOKEL ŠIFRA	DIMENZIJA (Ø mm)	ARTIKAL
1367068	12	M-PERFORMER

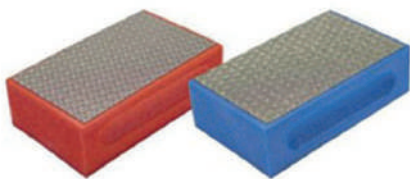

DT
DIJAMANTNE SPUŽVICE

VOKEL ŠIFRA	ARTIKAL
1367034	DT262



PDR
NOSAČ DIJAMANTNIH JASTUČIĆA ZA POLIRANJE

VOKEL ŠIFRA	ARTIKAL
1367058	PDR



PDR

DIJAMANTNI JASTUČIĆ POZICIJA "0"

VOKEL ŠIFRA	ARTIKAL
1367075	PDR0

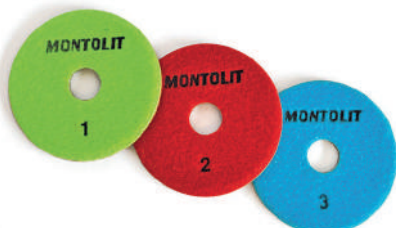

PDR KIT

SET DIJAMANTNIH JASTUČIĆA

VOKEL ŠIFRA	ARTIKAL
1367059	PDRKIT



MAGNETNI ODVAJAČ NEČISTOĆA

- Multifunkcionalni uređaj s hvatačem nečistoća i filterom
- Jedinstven jer u potpunosti čisti hidraulički krug s ciljem trajne zaštite generatora i ostalih komponenata
- Tijelo od tehnopolimera
- Hvatač nečistoća s unutarnjim elementom od tehnopolimera s magnetom
- Zaporni ventil s maticom, tijelo od mesinga
- Pogodno za okomite, vodoravne ili cijevi pod 45°C
- Ispusna slavina s priključkom za crijevom
- Pmax radni: 3bar
- Tmin-Tmax: 0-90°C
- Mehanička ozračna slavina
- Maksimalni protok 1"KVS (m³/h) 14,50

VOKEL ŠIFRA	OPIS	ARTIKAL
1781001	MAGNETNI ODVAJAČ NEČISTOĆA 1" S VENTILIMA	AFM-08B
1781002	MAGNETNI ODVAJAČ NEČISTOĆA 5/4" S VENTILIMA	AFM-08B
1781003	ZAMJENSKI FILTER ZA MAGNETNI ODVAJAČ NEČISTOĆA	RPF-SS

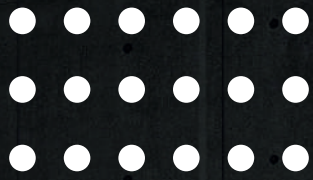

Aria^A



RUBIN WHITE

VISEĆA WC ŠKOLJKA BEZ DASKE



ŠIFRA VOKEL	DIMENZIJA (cm)	BOJA	ART.
1732001	53,5	WHITE	MGZ(Y)-3105B
1732002	53,5	WHITE MATT	MGZ(Y)-3105B-MW
1732004	48,2	WHITE	MGZ(Y)-3105
1732005	48,2	WHITE MATT	MGZ(Y)-3105MW

RUBIN WHITE

WC DASKA



ŠIFRA VOKEL	OPIS	BOJA	ART.
1732011	ZA ŠKOLJKE 1732001 i 1732004	WHITE	MO660
1732012	ZA ŠKOLJKE 1732002 i 1732005	WHITE MATT	MO660-MW

RUBIN BLACK

VISEĆA WC ŠKOLJKA BEZ DASKE



ŠIFRA VOKEL	DIMENZIJA (cm)	BOJA	ART.
1732003	53,5	BLACK MATT	MGZ(Y)-3105B-MB
1732006	48,2	BLACK MATT	MGZ(Y)-3105MB

RUBIN BLACK

WC DASKA



ŠIFRA VOKEL	OPIS	BOJA	ART.
1732013	ZA ŠKOLJKE 1732003 i 1732006	BLACK MATT	MO660-MB

OPAL

VISEĆA WC ŠKOLJKA BEZ DASKE



ŠIFRA VOKEL	BOJA	ART.
1732007	WHITE	MGZ - 20



VENETO

PODNA WC ŠKOLJKA - ODVOD U ZID, BEZ DASKE

ŠIFRA VOKEL	BOJA	ART.
1732008	WHITE	MKZ-45D



VENETO

WC DASKA

ŠIFRA VOKEL	OPIS	BOJA	ART.
1732014	ZA ŠKOLJKU 1732008	WHITE	MU6157



REZERVNI VIJCI

ZA VISEĆU WC ŠKOLJKU

ŠIFRA VOKEL	OPIS	ART.
1732015	ZA VISEĆU WC ŠKOLJKU RUBIN (1732004, 1732005, 1732006)	WS-001



REZERVNI VIJCI

ZA VISEĆU WC ŠKOLJKU

ŠIFRA VOKEL	OPIS	ART.
1732021	ZA WC VISEĆU WC ŠKOLJKU RUBIN (1732001, 1732002, 1732003)	WS-002



REZERVNI VIJCI

ZA WC DASKU

ŠIFRA VOKEL	OPIS
1732016	ZA WC DASKU 1732011



REZERVNI VIJCI

ZA WC DASKU

ŠIFRA VOKEL	OPIS
1732017	ZA WC DASKU 1732012



REZERVNI VIJCI
ZA WC DASKU

ŠIFRA VOKEL	OPIS
1732018	ZA WC DASKU 1732013



REZERVNI VIJCI
ZA WC ŠKOLJKU

ŠIFRA VOKEL	OPIS	ART.
1732019	ZA WC ŠKOLJKU VENETO 1732008	FS-001

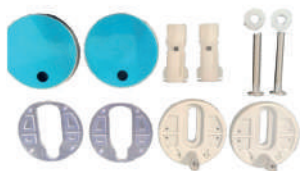

REZERVNI VIJCI
ZA WC DASKU

ŠIFRA VOKEL	OPIS	ART.
1732020	ZA WC DASKU 1732014	HG-MU6157

UMIVAONICI



TOPAZ

ŠIFRA VOKEL	OPIS	DIMENZIJA (cm)	BOJA	ART.
1732009	UMIVAONIK TOPAZ WHITE	53x46	WHITE	MHP-45



MOLISE

ŠIFRA VOKEL	OPIS	DIMENZIJA (cm)	BOJA	ART.
1732010	UMIVAONIK MOLISE WHITE	54,5x45,5	WHITE	MHP-14



VISOKOTEMPERATURNA DIZALICA TOPLINE

75°C

Zrak - Voda

- ▶ R290 Rashladni plin
- ▶ Energetska klasa: A+++
- ▶ Grijanje + Hlađenje + Topla voda
- ▶ DC inverterski kompresor i motor ventilatora
- ▶ Maksimalna izlazna temperatura: 75°C
- ▶ WiFi upravljanje
- ▶ Inverterska cirkulacijska pumpa
- ▶ Modbus RS485

DIZALICA TOPLINE je uređaj s vrlo visokim stupnjem iskorištenja, koji energiju crpi iz okoliša. Energiju koju crpi ovaj uređaj priroda daje potpuno besplatno. Osim grijanja i pripreme sanitarne tople vode ovi uređaji mogu služiti i za hlađenje, što je velika prednost u odnosu na tradicionalne sustave koji služe samo za grijanje. Za rad ovih uređaja nije potrebna izgradnja dimnjaka, a za instalaciju je potreban samo 1 m².



Visokotemperaturna dizalica topline za grijanje + hlađenje + PTV (Monoblok R290)
Značajke:

1. R290 rashladni plin
2. Energetska klasa: A+++
3. Grijanje+Hlađenje+PTV
4. DC inverter kompresor i motor ventilatora
5. Maksimalna temperatura vode: 75°C
6. WiFi pametno upravljanje
7. Inverterska cirkulacijska pumpa (ugrađena)
8. Modbus RS485 (internet dijagnostika)



MODEL		BLN-006TC1	BLN-008TC1	BLN-012TC1	BLN-012TC3	BLN-018TC1	BLN-018TC3	
Napajanje	V/Ph/Hz	220~240/1/50	220~240/1/50	220~240/1/50	380~415/3/50	220~240/1/50	380~415/3/50	
Presjek kabela	mm ²	4	4	4	4	6	4	
Nominalno grijanje (Max) (A7/6°C, W30/35°C)	Kapacitet grijanja	kW	2.92~9.10	4.10~12.10	4.30~15.20	4.30~15.20	7.24~21.90	7.24~21.90
	Ulazna snaga	kW	0.61~2.11	0.79~2.85	0.87~3.73	0.87~3.73	1.05~5.73	1.50~5.73
	Ulazna struja	A	2.80~9.25	3.45~13.04	4.02~16.38	1.78~6.04	6.86~30.25	2.82~9.16
	COP	W/W	4.31~5.66	4.24~5.57	4.08~5.75	4.08~5.57	3.82~5.59	3.82~5.59
Nominalno grijanje (Max) (A7/6°C, W47/55°C)	Kapacitet grijanja	kW	2.99~8.16	4.05~11.95	4.25~14.55	4.25~14.55	6.36~19.45	6.36~19.45
	Ulazna snaga	kW	1.03~2.92	1.38~4.01	1.45~4.78	1.45~4.78	2.15~6.75	2.15~6.75
	Ulazna struja	A	4.57~12.79	5.73~17.70	6.71~18.80	2.84~6.78	9.84~30.12	3.71~10.60
	COP	W/W	2.79~3.46	2.98~3.45	3.04~3.45	3.04~3.45	2.88~3.75	2.88~3.75
Nominalno hlađenje (Max) (A35/24°C, W12/7°C)	Kapacitet hlađenja	kW	1.38~5.70	3.65~8.59	3.65~11.04	3.65~11.04	4.55~17.20	4.55~17.20
	Ulazna snaga	kW	0.67~2.44	1.12~3.31	1.12~3.37	1.12~4.37	1.85~7.31	1.85~7.31
	Ulazna struja	A	3.06~10.27	5.18~14.47	5.18~17.44	1.97~6.30	8.47~32.1	2.99~11.26
ERP razina (Temperatura polaza vode 35°C)	/	A+++	A+++	A+++	A+++	A+++	A+++	
Nazivna ulazna snaga	kW	3,50	5,40	5,40	5,85	7,50	10,50	
Nazivna ulazna struja	A	15,0	25,0	25,0	10,0	35,0	17,0	
Tip rashladnog sredstva / Punjenje	/kg	R290/0.55	R290/1.05	R290/1.05	R290/1.05	R290/1.40	R290/1.40	
CO ₂ Ekvivalent	/	0.0017t	0.0032t	0.0032t	0.0032t	0.0042t	0.0042t	
Radni tlak (Niski)	MPa	0,8	0,8	0,8	0,8	0,8	0,8	
Radni tlak (Visoki)	MPa	3,0	3,0	3,0	3,0	3,0	3,0	
Maksimalni dozvoljeni tlak	MPa	3,2	3,2	3,2	3,2	3,2	3,2	
Nazivni protok vode	m ³ /h	1,00	1,40	2,06	2,06	3,10	3,10	
Broj ventilatora	/	1	1	1	1	2	2	
Tip motora ventilatora	/	DC inverter						
Tip kompresora	/	DC inverter						
Cirkulacijska pumpa	/	Inverterski tip / Ugrađena						
IP klasa	/	IPX4						
Razina buke (1 m udaljenost)	dB(A)	46	43	53	54	56	56	
Maksimalna temperatura vode na prolazu	°C	75	75	75	75	75	75	
Hidraulički priključak	inch	G1	G1	G1	G1	G1-1/4	G1-1/4	
Pad tlaka vode (Max)	kPa	20	20	20	20	55	55	
Radni raspon (Grijanje)	°C	-25~45						
Radni raspon (Hlađenje)	°C	16~45						
Dimenzije uređaja (DxŠxV)	mm	1187x418x808	1287x438x908	1287x438x908	1287x438x908	1187x488x1460	1187x488x1460	
Dimenzije uređaja u kutiji (DxŠxV)	mm	1217x463x920	1317x493x1020	1317x493x1020	1317x493x1020	1217x538x1570	1217x538x1570	
Težina uređaja	kg	110	134	134	134	195	195	
Težina uređaja s kutijom	kg	125	153	153	153	210	210	

VOKEL ŠIFRA	OPIS	SNAGA (kW)	ARTIKAL
1482001	VISOKOTEMPERATURNA DIZALICA TOPLINE - MONOFAZNA	6	31070002000158
1482006	VISOKOTEMPERATURNA DIZALICA TOPLINE - MONOFAZNA	8	31070002000185
1482002	VISOKOTEMPERATURNA DIZALICA TOPLINE - MONOFAZNA	12	31070002000159
1482003	VISOKOTEMPERATURNA DIZALICA TOPLINE - TROFAZNA	12	31070002000160
1482004	VISOKOTEMPERATURNA DIZALICA TOPLINE - MONOFAZNA	18	31070002000161
1482005	VISOKOTEMPERATURNA DIZALICA TOPLINE - TROFAZNA	18	31070002000162

NISKOTEMPERATURNA DIZALICA TOPLINE

60°C

Zrak - Voda

- ▶ R32 rashladni plin
- ▶ Energetska klasa: A+++
- ▶ Grijanje+Hlađenje+PTV
- ▶ DC inverter kompresor s EVI tehnologijom
- ▶ Maksimalna temperatura vode: 60°C
- ▶ WiFi pametno upravljanje
- ▶ Inverterska cirkulacijska pumpa (ugrađena)
- ▶ Modbus RS485 (internet dijagnostika)
- ▶ Dvostruka temperaturna zona
- ▶ SG Ready

Zahvaljujući EVI tehnologiji koja omogućuje mirniji rad kompresora i bolje performanse na nižim vanjskim temperaturama, ove dizalice topline su pravi izbor za niskotemperaturne režime grijanja. Uz grijanje ili hlađenje mogu osigurati i sanitarnu toplu vodu, što ih čini savršenim uređajem za vaš dom.



Niskotemperaturna dizalica topline za grijanje + hlađenje + PTV (Monoblok R32)

Značajke:

1. R32 rashladni plin
2. Energetska klasa: A+++
3. Grijanje+Hlađenje+PTV
4. DC inverter kompresor s EVI tehnologijom
5. Maksimalna temperatura vode: 60°C
6. WiFi pametno upravljanje
7. Inverterska cirkulacijska pumpa (ugrađena)
8. Modbus RS485 (internet dijagnostika)
9. Dvostruka temperaturna zona
10. SG Ready



MODEL		BLN-006TD1	BLN-010TD1	BLN-014TD1	BLN-014TD3	BLN-018TD1	BLN-018TD3	BLN-024TD3	
Napajanje	V/Ph/Hz	220~240/1/50	220~240/1/50	220~240/1/50	380~415/3/50	220~240/1/50	380~415/3/50	380~415/3/50	
Presjek kabela	mm ²	2,5	4	4	4	6	6	6	
Grijanje (Min-Max) (A7/6°C, W30/35°C)	Kapacitet grijanja	kW	2,50~8,3	4,20~12,20	5,30~16,50	5,30~16,50	6,20~20,50	6,20~20,50	6,50~26,10
	Ulazna snaga	kW	0,57~1,92	0,86~2,88	1,15~4,15	1,15~4,15	1,36~5,28	1,36~5,28	1,78~6,45
	Ulazna struja	A	2,53~8,52	3,82~12,77	5,10~18,41	1,86~6,70	6,10~23,67	2,31~8,96	2,87~10,35
	COP	W/W	4,32~5,86	4,23~5,39	3,97~5,43	3,97~5,43	3,88~5,21	3,88~5,21	4,04~5,43
Grijanje (Min-Max) (A7/6°C, W47/55°C)	Kapacitet grijanja	kW	2,30~7,62	3,85~11,20	4,90~15,10	4,90~15,10	6,30~19,90	6,30~19,90	6,90~26,10
	Ulazna snaga	kW	0,75~2,61	1,13~3,75	1,67~5,25	1,65~5,25	1,65~6,82	1,65~6,82	1,95~8,55
	Ulazna struja	A	3,32~11,58	5,01~16,60	7,32~23,30	1,67~8,47	7,40~30,56	2,80~11,58	3,15~13,80
	COP	W/W	2,92~3,33	2,99~3,46	2,87~3,38	2,87~3,38	2,91~3,34	2,91~3,34	3,05~3,42
Hlađenje (Min-Max) (A35/24°C, W12/7°C)	Kapacitet hlađenja	kW	1,80~7,10	2,60~10,30	4,50~13,50	4,50~13,50	5,50~17,50	5,50~17,50	5,20~21,30
	Ulazna snaga	kW	0,61~2,43	0,91~3,65	1,45~4,85	1,45~4,85	1,65~6,25	1,65~6,25	1,95~8,20
	Ulazna struja	A	2,71~10,78	4,03~16,19	6,43~21,52	2,34~7,82	7,40~28,02	2,80~10,61	3,15~13,23
ERP razina (Temperatura polaza vode 35°C)	/	A+++	A+++	A+++	A+++	A+++	A+++	A+++	
Nazivna ulazna snaga	kW	2,71	3,83	6,20	6,20	7,50	7,50	10,00	
Nazivna ulazna struja	A	12,00	17,00	27,50	10,50	35,00	13,00	17,00	
Tip rashladnog sredstva / Punjenje	/kg	R32/1,25	R32/1,8	R32/2,8	R32/2,8	R32/3,5	R32/3,5	R32/3,5	
CO ₂ Ekvivalent	/	0,844 t	1,215 t	1,890 t	1,890 t	2,363 t	2,363 t	2,363 t	
Radni tlak (Niski)	MPa	1,5	1,5	1,5	1,5	1,5	1,5	1,5	
Radni tlak (Visoki)	MPa	4,4	4,4	4,4	4,4	4,4	4,4	4,4	
Maksimalni dozvoljeni tlak	MPa	4,4	4,4	4,4	4,4	4,4	4,4	4,4	
Nazivni protok vode	m ³ /h	1,10	1,75	2,52	2,52	3,20	3,20	4,12	
Broj ventilatora	/	1	1	1	1	2	2	2	
Tip motora ventilatora	/	DC inverter							
Tip kompresora	/	Panasonic / DC inverter / Rotacijski / EVI							
Cirkulacijska pumpa	/	Inverterski tip / Ugrađena							
Otpornost na električni udar	/	I							
IP klasa	/	IPX4							
Razina buke (1 m udaljenosti)	dB(A)	49	52	54	54	56	55	58	
Maksimalna temperatura vode na polazu	°C	60	60	60	60	60	60	60	
Hidraulički priključak (muški)	inch	G1	G1	G1-1/4	G1-1/4	G1-1/2	G1-1/2	G1-1/2	
Pad tlaka vode (Max)	kPa	25	27	30	30	32	32	35	
Radni raspon (Grijanje)	°C	-25~45							
Radni raspon (Hlađenje)	°C	16~45							
Dimenzije uređaja (DxŠxV)	mm	1108x466x856	1108x466x856	1108x466x856	1108x466x856	1118x428x1449	1118x428x1449	1118x428x1449	
Dimenzije uređaja u kutiji (DxŠxV)	mm	1160x530x1010	1160x530x1010	1160x565x1010	1160x565x1010	1170x530x1610	1170x530x1610	1170x530x1610	
Težina uređaja	kg	102	107	124	124	151	151	160	
Težina uređaja s kutijom	kg	114	119	136	136	168	168	177	

VOKEL ŠIFRA	OPIS	SNAGA (kW)	ARTIKAL
1491001	NISKOTEMPERATURNNA DIZALICA TOPLINE - MONOFAZNA	6	31070002000070
1491002	NISKOTEMPERATURNNA DIZALICA TOPLINE - MONOFAZNA	10	31070002000075
1491003	NISKOTEMPERATURNNA DIZALICA TOPLINE - MONOFAZNA	14	31070002000076
1491004	NISKOTEMPERATURNNA DIZALICA TOPLINE - TROFAZNA	14	31070002000072
1491005	NISKOTEMPERATURNNA DIZALICA TOPLINE - MONOFAZNA	18	31070002000077
1491006	NISKOTEMPERATURNNA DIZALICA TOPLINE - TROFAZNA	18	31070002000073
1491007	NISKOTEMPERATURNNA DIZALICA TOPLINE - TROFAZNA	24	31070002000074

HEATSENSE

Katalog proizvoda





ELEKTRIČNA GRIJAĆA MREŽA

- » **Konstrukcija kabela:** Dvožilni vodič
- » **Jamstvo:** 20 godina
- » **Izolacija vodiča:** FEP
- » **Metalni omotač:** 100% aluminijska folija
- » **Vanjski omotač:** PVDF
- » **Debljina kabela:** 3 mm
- » **Razmak kabela:** 80 mm
- » **Snaga:** 150W/m²
- » **Napon:** 230 V
- » **Zaštita:** IPX7
- » **Samoljepljiva**

VOKEL ŠIFRA	OPIS	SNAGA (W)	DIMENZIJE DxŠ	OTPOR Ω	ARTIKAL
1487001	ELEKTRIČNA GRIJAĆA MREŽA 1.0 m ²	150 W	2x0,5 m	352.7	HS-MAT 1.0m ²
1487002	ELEKTRIČNA GRIJAĆA MREŽA 1.5 m ²	225 W	3x0,5 m	235.1	HS-MAT 1.5m ²
1487003	ELEKTRIČNA GRIJAĆA MREŽA 2.0 m ²	300 W	4x0,5 m	176.3	HS-MAT 2.0m ²
1487004	ELEKTRIČNA GRIJAĆA MREŽA 2.5 m ²	375 W	5x0,5 m	141.1	HS-MAT 2.5m ²
1487005	ELEKTRIČNA GRIJAĆA MREŽA 3.0 m ²	450 W	6x0,5 m	117.6	HS-MAT 3.0m ²
1487006	ELEKTRIČNA GRIJAĆA MREŽA 3.5 m ²	525 W	7x0,5 m	100.8	HS-MAT 3.5m ²
1487007	ELEKTRIČNA GRIJAĆA MREŽA 4.0 m ²	600 W	8x0,5 m	88.2	HS-MAT 4.0m ²
1487008	ELEKTRIČNA GRIJAĆA MREŽA 5.0 m ²	750 W	10x0,5 m	70.5	HS-MAT 5.0m ²
1487009	ELEKTRIČNA GRIJAĆA MREŽA 6.0 m ²	900 W	12,0,5 m	58.8	HS-MAT 6.0m ²
1487010	ELEKTRIČNA GRIJAĆA MREŽA 7.0 m ²	1050 W	14x0,5 m	50.4	HS-MAT 7.0m ²
1487011	ELEKTRIČNA GRIJAĆA MREŽA 8.0 m ²	1200 W	16x0,5 m	44.1	HS-MAT 8.0m ²
1487012	ELEKTRIČNA GRIJAĆA MREŽA 9.0 m ²	1350 W	18x0,5 m	39.2	HS-MAT 9.0m ²
1487013	ELEKTRIČNA GRIJAĆA MREŽA 10.0 m ²	1500 W	20x0,5 m	35.3	HS-MAT 10.0m ²
1487014	ELEKTRIČNA GRIJAĆA MREŽA 12.0 m ²	1800 W	24x0,5 m	29.4	HS-MAT 12.0m ²

ANALOGNI TERMOSTAT



- » **Jamstvo:** 2 godine
- » **Napon:** 230 V
- » **Raspon temperature:** 5°C - 40°C
- » **LED indikator:** On/Off
- » **Zaštita:** IP20
- » **Nazivna struja:** 16A
- » **Podni senzor:** NTC senzor

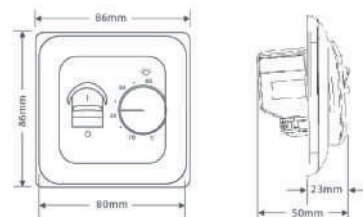

VOKEL ŠIFRA	BOJA	ARTIKAL
1488001	BIJELA	HS-50W

DIGITALNI INTERNET TERMOSTAT



- » **Jamstvo:** 2 godine
- » **Napon:** 230 V
- » **Zaštita:** IP20
- » **Nazivna struja:** 16A
- » **Podni senzor:** NTC senzor

1. Termostat s tjednim programom
2. WIFI konekcija
3. Ultra veliki LCD ekran
4. Može se individualno prilagoditi osobnim potrebama - može se postaviti do 6 intervala grijanja zasebno
5. Preporučuje se za upravljanje el. podnim mrežama

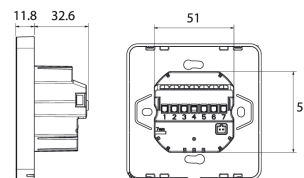

VOKEL ŠIFRA	BOJA	ARTIKAL
1488002	BIJELA	HS-100WIFIW
1488003	CRNA	HS-101WIFIB

DIGITALNI TERMOSTAT



- » **Jamstvo:** 2 godine
- » **Napon:** 230 V
- » **Zaštita:** IP20
- » **Nazivna struja:** 16A
- » **Podni senzor:** NTC senzor

1. Termostat s tjednim programom
2. Ultra veliki LCD ekran
3. Može se individualno prilagoditi osobnim potrebama - može se postaviti do 6 intervala grijanja zasebno
4. Preporučuje se za upravljanje el. podnim mrežama

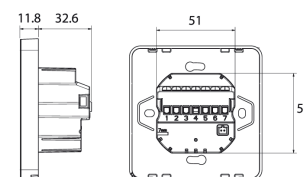

VOKEL ŠIFRA	BOJA	ARTIKAL
1488004	BIJELA	HS-110W
1488005	CRNA	HS-111B



MOTORNI POGON

- » NC - Normalno zatvaranje
- » Napon: 230V

VOKEL ŠIFRA	OPIS	ARTIKAL
1488006	MOTORNI POGON M30X1,5	HS-230NC

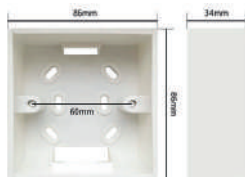

NADŽBUKNA KUTIJA

- » Dimenzija: 86x86x34 mm



VOKEL ŠIFRA	OPIS	ARTIKAL
1488007	NADŽBUKNA KUTIJA ZA TERMOSTAT	HS-8601

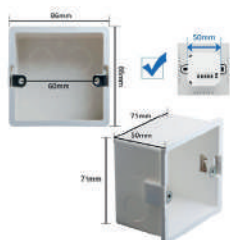

PODŽBUKNA KUTIJA

- » Dimenzija: 86x86x50 mm



VOKEL ŠIFRA	OPIS	ARTIKAL
1488008	PODŽBUKNA KUTIJA ZA TERMOSTAT	HS-8602

SENZOR

- » Dužina: 3 m



VOKEL ŠIFRA	OPIS	ARTIKAL
1488009	PODNI SENZOR	HS-3950

SENZOR

- » Dužina: 3 m



VOKEL ŠIFRA	OPIS	ARTIKAL
1488010	PODNI SENZOR	HS-3380



SUPAL POSTOLJE

FIKSNI I SAMONIVELIRAJUĆI SA NAGBIOM DO 5%

VOKEL ŠIFRA	OPIS
1694001	NISKO POSTOLJE ZA PODIGNUTE PODOVE 28-43 mm



SUPAS POSTOLJE

FIKSNI I SAMONIVELIRAJUĆI SA NAGBIOM DO 5%

VOKEL ŠIFRA	OPIS
1694002	POSTOLJE ZA PODIGNUTE PODOVE 43-58 mm



SUPT4 POSTOLJE

KOMBINIRATI SA SUPB-MAX 3 SUPB

VOKEL ŠIFRA	OPIS
1694007	NISKO POSTOLJE ZA PODIGNUTE PODOVE 10-15 mm FUGA 4 mm



SUPB BAZA

ZA VEĆU VISINU +5 mm

VOKEL ŠIFRA	OPIS
1694008	PRODUŽETAK ZA POSTOLJE SUPT4 PODEŠAVANJE DO 30 mm MAX 3 SUPB



SUPAR PRSTEN

ZA PODIZANJE VISINE +30 mm

VOKEL ŠIFRA	OPIS
1694003	PRSTEN ZA PODIZANJE VISINE 3 cm, MOŽE SE KORISTITI POJEDINAČNO ILI VIŠE SUPAR (PRSTENOVA)



SUPAR120 PRSTEN

ZA PODIZANJE VISINE +120 mm

VOKEL ŠIFRA	OPIS
1694004	PRSTEN ZA PODIZANJE VISINE 12 cm, MOŽE SE KORISTITI POJEDINAČNO ILI VIŠE SUPAR (PRSTENOVA)



SUPA4 ZAVRŠNI KOMAD

FUGA 4 mm

VOKEL ŠIFRA	OPIS
1694005	DODATAK S GUMOM KOJA JAMČI SMANJENJE BUKE I PROTUKLIZNOST



SUPA2 ZAVRŠNI KOMAD

FUGA 2 mm

VOKEL ŠIFRA	OPIS
1694006	DODATAK S GUMOM KOJA JAMČI SMANJENJE BUKE I PROTUKLIZNOST

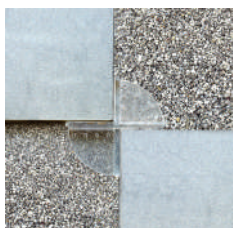

DISC10 ABS BAZA ZA POLAGANJE

FUGA 3 mm

VOKEL ŠIFRA	OPIS
1694009	BAZA ZA POLAGANJE FUGA 3 mm, H=10 mm NA PLOČICE, PRIRODNI KAMEN, ESTRIH



SUPACL PB DONJA KOPČA

ZA IZRADU OBODNIH RUBOVA

VOKEL ŠIFRA	OPIS
1694010	SPOJNICA KOJA SE POSTAVLJA NA PODNOŽJE NOSAČA ZA IZRADU OBODNIH RUBOVA S PROFILOM ILI PLOČICAMA



SUPACL PT GORNJA KOPČA

ZA IZRADU OBODNIH RUBOVA

VOKEL ŠIFRA	OPIS
1694011	SPOJNICA KOJA SE POSTAVLJA NA GLAVU NOSAČA ZA IZRADU OBODNIH RUBOVA S PROFILOM ILI PLOČICAMA



SUPACLPP ZIDNA KOPČA

PRIMJENJIVO NA SUPA2 I SUPA4

VOKEL ŠIFRA	OPIS
1694012	METALNA KOPČA ZA PRAVILNO RASPOREĐIVANJE NOSAČA KADA SE OSLANJAJU NA ZID



SUPAK KLJUČ ZA POSTOLJE

METALNI KLJUČ ZA PODEŠAVANJE

VOKEL ŠIFRA	OPIS
1694013	PODEŠAVANJE NA 3 NAČINA: 1.PROMJENA FIKSNE GLAVE NA SAMONIVELIRAJUĆU 2.UKLANJANJE BAZA ZA VEZIVANJE 3.PODEŠAVANJE VISINE

UZORCI ZA POLAGANJE

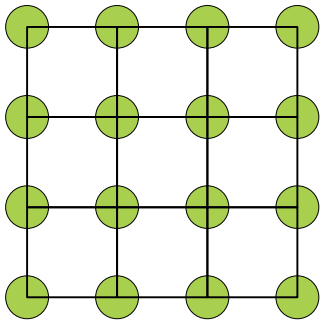

40x40 cm

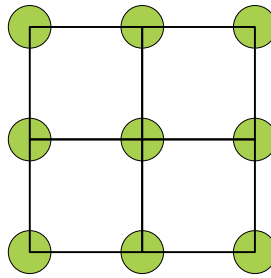

50x50 cm

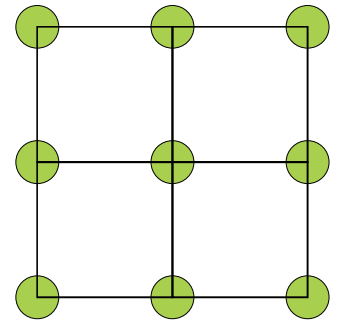

60x60 cm

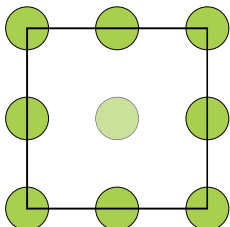

80x80 cm

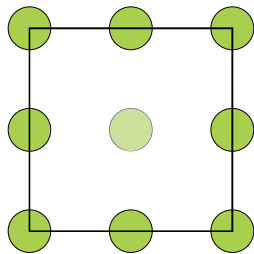

90x90 cm

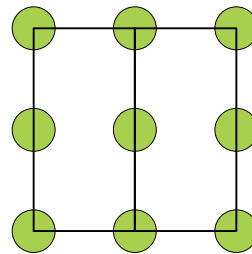

40x80 cm

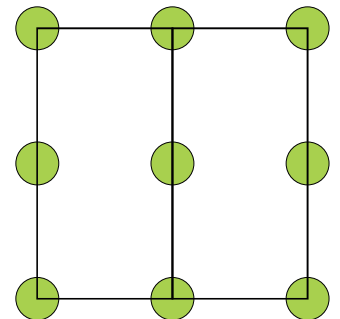

45x90 cm

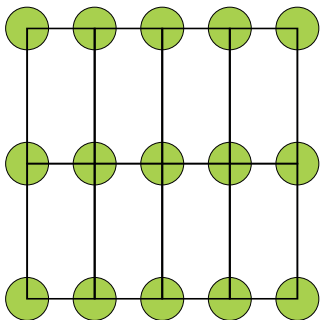

30x60 cm

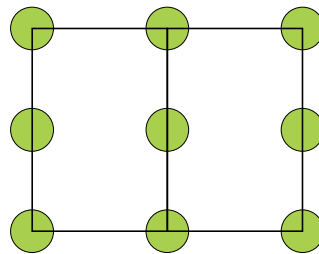

60x90 cm

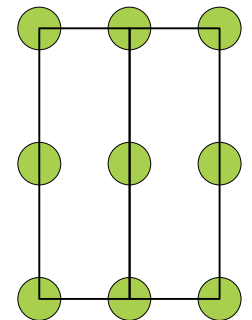

40x120 cm

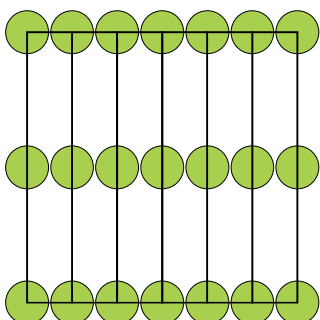

20x120 cm

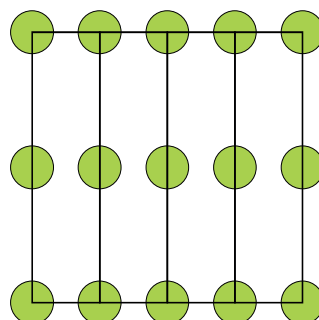

30x120 cm

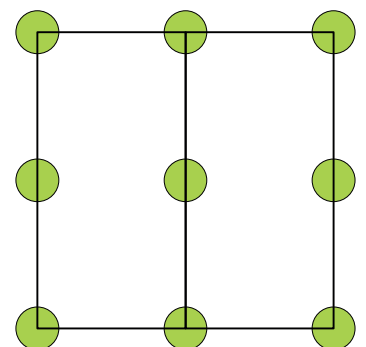

60x120 cm

POTROŠNJA NOSAČA NA m2

TILE SIZE	20	30	40	45	50	60	70	75	80	90	100
20	25	16,67	12,5	11,11	10	8,33	14,29	13,33	12,5	11,11	10
30	16,67	11,11	8,33	7,41	6,67	5,56	9,52	8,89	8,33	7,41	6,67
40	12,5	8,33	6,5	5,56	5	4,17	7,14	6,67	6,65	5,56	5
45	11,1	7,41	5,56	4,94	4,44	3,7	6,35	5,63	5,56	4,94	4,44
50	10	6,67	5	4,44	4	3,33	5,71	5,33	5	4,44	4
60	8,3	5,56	4,17	3,7	3,33	2,78	4,76	4,44	4,17	3,7	3,33
70	14,29	9,52	7,14	6,35	5,71	4,76	4,08	3,81	3,57	3,17	2,86
75	13,33	8,89	6,67	5,93	5,33	4,44	3,81	3,56	3,33	2,96	2,67
80	12,5	8,33	6,25	5,56	5	4,17	3,57	3,33	6,25	5,59	5
90	11,11	7,41	5,56	4,94	4,44	3,7	3,17	2,96	5,56	4,94	4,44
100	10	6,67	5	4,44	4	3,33	2,86	2,67	5	4,44	4
120	8,33	5,56	4,17	3,7	3,33	2,78	2,38	2,22	4,17	3,7	3,33
140	14,29	9,52	7,14	6,35	5,71	4,76	2,04	1,9	3,57	3,17	2,86
160	12,5	8,33	6,25	5,56	5	4,17	3,57	3,33	6,25	5,56	5
180	8,33	5,56	4,17	3,7	3,33	2,78	2,38	2,22	4,17	3,7	3,33

Tablica daje čisto matematičku procjenu potrošnje bez uzimanja u obzir svih varijabli lokacije. Preporučuje se da se navedene vrijednosti povećaju za 5-15%.



SUPAL	SUPAS	SUPAS + 1 SUPAR	SUPAS + 2 SUPAR	SUPAS + 3 SUPAR	SUPAS + 1 SUPAR120
28-43 mm	43-58 mm	58-88 mm	88-118 mm	118-148 mm	148-178 mm

LAPIS

KATALOG PROIZVODA





LAPIS GREY 80, 100 cm

PLOČA S UMIVAONIKOM

VOKEL ŠIFRA	OPIS	ARTIKAL
1741001	GORNJA PLOČA S UMIVAONIKOM LAPIS GREY 80x50x15 cm	AY01-80 (6008)
1741003	GORNJA PLOČA S UMIVAONIKOM LAPIS GREY 100x50x15 cm	AY01-100(6008)

PREPORUČENI NOSAČI ZA GORNJE PLOČE

VOKEL ŠIFRA	OPIS	PAKIRANJE (KOM)
1196010	NOSAČ PLOČE ZA UMIVAONIK TIP-L-450	2



LAPIS GREY 80, 100 cm

DONJA PLOČA

VOKEL ŠIFRA	OPIS	ARTIKAL
1741002	PLOČA S RUPOM LAPIS GREY 80x50x8 cm	AY01-80 (6008)
1741004	PLOČA S RUPOM LAPIS GREY 100x50x8 cm	AY01-100(6008)





LAPIS CALACCATA 80,100 cm

PLOČA S UMIVAONIKOM

VOKEL ŠIFRA	OPIS	ARTIKAL
1741005	GORNJA PLOČA S UMIVAONIKOM LAPIS CALACCATA 80x50x15 cm	AY01-80 (6001)
1741007	GORNJA PLOČA S UMIVAONIKOM LAPIS CALACCATA 100x50x15 cm	AY01-100 (6001)

PREPORUČENI NOSAČI ZA GORNJE PLOČE

VOKEL ŠIFRA	OPIS	PAKIRANJE (KOM)
1196010	NOSAČ PLOČE ZA UMIVAONIK TIP-L-450	2



LAPIS CALACCATA 80,100 cm

DONJA PLOČA

VOKEL ŠIFRA	OPIS	ARTIKAL
1741006	PLOČA S RUPOM LAPIS CALACCATA 80x50x8 cm	AY01-80 (6001)
1741008	PLOČA S RUPOM LAPIS CALACCATA 100x50x8 cm	AY01-100 (6001)





LAPIS CALACCATA GOLD 80,100 cm

PLOČA S UMIVAONIKOM

VOKEL ŠIFRA	OPIS	ARTIKAL
1741009	GORNJA PLOČA S UMIVAONIKOM LAPIS GOLD CALACCATA 80x50x15 cm	AY01-80 (6017)
1741011	GORNJA PLOČA S UMIVAONIKOM LAPIS GOLD CALACCATA 100x50x15 cm	AY01-100 (6017)

PREPORUČENI NOSAČI ZA GORNJE PLOČE

VOKEL ŠIFRA	OPIS	PAKIRANJE (KOM)
1196010	NOSAČ PLOČE ZA UMIVAONIK TIP-L-450	2

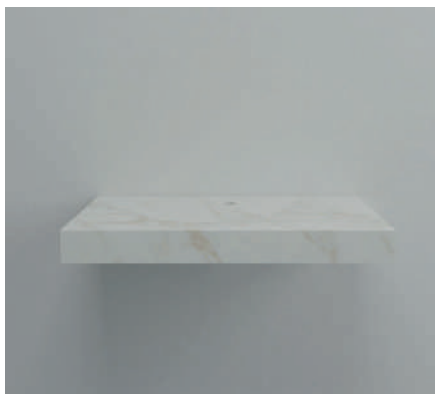

LAPIS CALACCATA GOLD 80,100 cm

DONJA PLOČA

VOKEL ŠIFRA	OPIS	ARTIKAL
1741010	PLOČA S RUPOM LAPIS GOLD CALACCATA 80x50x8 cm	AY01-80 (6017)
1741012	PLOČA S RUPOM LAPIS GOLD CALACCATA 100x50x8 cm	AY01-100 (6017)





LAPIS CEDAR

PLOČA ZA UMIVAONIK

VOKEL ŠIFRA	OPIS	ARTIKAL
1741013	PLOČA ZA UMIVAONIK LAPIS CEDAR 60x50x13cm	4010-60 (6075)
1741014	PLOČA ZA UMIVAONIK LAPIS CEDAR 80x50x13cm	4010-80 (6075)
1741015	PLOČA ZA UMIVAONIK LAPIS CEDAR 100x50x13cm	4010-100 (6075)
1741016	PLOČA ZA UMIVAONIK LAPIS CEDAR 120x50x13cm	4010-120 (6075)

PREPORUČENI NOSAČI ZA GORNJE PLOČE

VOKEL ŠIFRA	OPIS	PAKIRANJE (KOM)
1196010	NOSAČ PLOČE ZA UMIVAONIK TIP-L-450	2

* Umivaonik se prodaje posebno



LAPIS WALNUT

PLOČA ZA UMIVAONIK

VOKEL ŠIFRA	OPIS	ARTIKAL
1741017	PLOČA ZA UMIVAONIK LAPIS WALNUT 60x50x13cm	4010-60 (6077)
1741018	PLOČA ZA UMIVAONIK LAPIS WALNUT 80x50x13cm	4010-80 (6077)
1741019	PLOČA ZA UMIVAONIK LAPIS WALNUT 100x50x13cm	4010-100 (6077)
1741020	PLOČA ZA UMIVAONIK LAPIS WALNUT 120x50x13cm	4010-120 (6077)

PREPORUČENI NOSAČI ZA GORNJE PLOČE

VOKEL ŠIFRA	OPIS	PAKIRANJE (KOM)
1196010	NOSAČ PLOČE ZA UMIVAONIK TIP-L-450	2

* Umivaonik se prodaje posebno



LAPIS PURE BLACK

PLOČA ZA UMIVAONIK

VOKEL ŠIFRA	OPIS	ARTIKAL
1741021	PLOČA ZA UMIVAONIK LAPIS PURE BLACK 60x50x13cm	4010-60 (6010)
1741022	PLOČA ZA UMIVAONIK LAPIS PURE BLACK 80x50x13cm	4010-80 (6010)
1741023	PLOČA ZA UMIVAONIK LAPIS PURE BLACK 100x50x13cm	4010-100 (6010)
1741024	PLOČA ZA UMIVAONIK LAPIS PURE BLACK 120x50x13cm	4010-120 (6010)

PREPORUČENI NOSAČI ZA GORNJE PLOČE

VOKEL ŠIFRA	OPIS	PAKIRANJE (KOM)
1196010	NOSAČ PLOČE ZA UMIVAONIK TIP-L-450	2

* Umivaonik se prodaje posebno

LAPIS PURE WHITE

PLOČA ZA UMIVAONIK



VOKEL ŠIFRA	OPIS	ARTIKAL
1741025	PLOČA ZA UMIVAONIK LAPIS PURE WHITE 60x50x13cm	4010-60 (6009)
1741026	PLOČA ZA UMIVAONIK LAPIS PURE WHITE 80x50x13cm	4010-80 (6009)
1741027	PLOČA ZA UMIVAONIK LAPIS PURE WHITE 100x50x13cm	4010-100 (6009)
1741028	PLOČA ZA UMIVAONIK LAPIS PURE WHITE 120x50x13cm	4010-120 (6009)

PREPORUČENI NOSAČI ZA GORNJE PLOČE

VOKEL ŠIFRA	OPIS	PAKIRANJE (KOM)
1196010	NOSAČ PLOČE ZA UMIVAONIK TIP-L-450	2

* Umivaonik se prodaje posebno



LAJSNE ZA KERAMIKU I PODNE OBLOGE

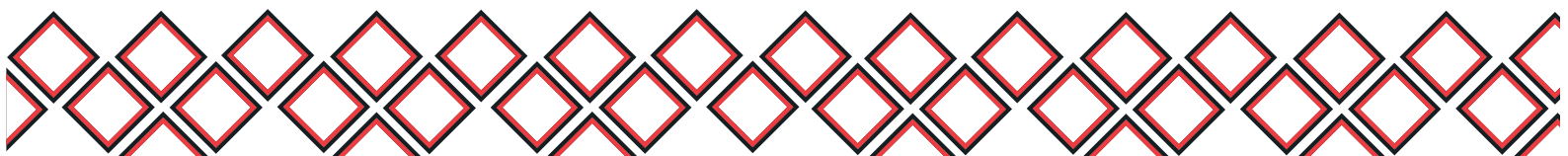

STIQ LAJSNA
S810

- Lajsna koja se koristi kod postavljanja keramike
- Materijal lajsne: stirplastika
- Karakteristike: vodootporna, otporna na udarce
- Ugradnja: montažno ljepilo

VOKEL ŠIFRA	BOJA	DUŽINA (m)	ARTIKAL
1209001	BIJELA	2,2	10545

STIQ LAJSNA
S610

- Lajsna koja se koristi kod postavljanja keramike
- Materijal lajsne: stirplastika
- Karakteristike: vodootporna, otporna na udarce
- Ugradnja: montažno ljepilo

VOKEL ŠIFRA	BOJA	DUŽINA (m)	ARTIKAL
1209002	BIJELA	2,2	10544

STIQ XL LAJSNA
STX610

- Lajsna koja se koristi za sve vrste podnih obloga
- Materijal lajsne: stirplastika
- Karakteristike: vodootporna, otporna na udarce
- Ugradnja: montažno ljepilo

VOKEL ŠIFRA	BOJA	DUŽINA (m)	ARTIKAL
1209003	BIJELA	2,2	10541

**STIQ LAJSNA**

S810

- Lajsna koja se koristi za sve vrste podnih obloga
- Materijal lajsne: stirplastika
- Karakteristike: vodootporna, otporna na udarce
- Ugradnja: montažno ljepilo

VOKEL ŠIFRA	BOJA	DUŽINA (m)	ARTIKAL
1209004	BIJELA	2,2	10542

**STIQ LAJSNA**

S610

- Lajsna koja se koristi za sve vrste podnih obloga
- Materijal lajsne: stirplastika
- Karakteristike: vodootporna, otporna na udarce
- Ugradnja: montažno ljepilo

VOKEL ŠIFRA	BOJA	DUŽINA (m)	ARTIKAL
1209005	BIJELA	2,2	10543

**STIQ XL LAJSNA**

STX610

- Lajsna koja se koristi kod postavljanja keramike
- Materijal lajsne: stirplastika
- Karakteristike: vodootporna, otporna na udarce
- Ugradnja: montažno ljepilo

VOKEL ŠIFRA	BOJA	DUŽINA (m)	ARTIKAL
1209006	BIJELA	2,4	10876



PROFIFLOOR LAJSNA

PF-6015

- Lajsna koja se koristi kod postavljanja keramike
- Materijal lajsne: stирplastika
- Karakteristike: vodootporna, otporna na udarce
- Ugradnja: montažno ljepilo

VOKEL ŠIFRA	BOJA	DUŽINA (m)	ARTIKAL
1209007	BIJELA	2,4	10875

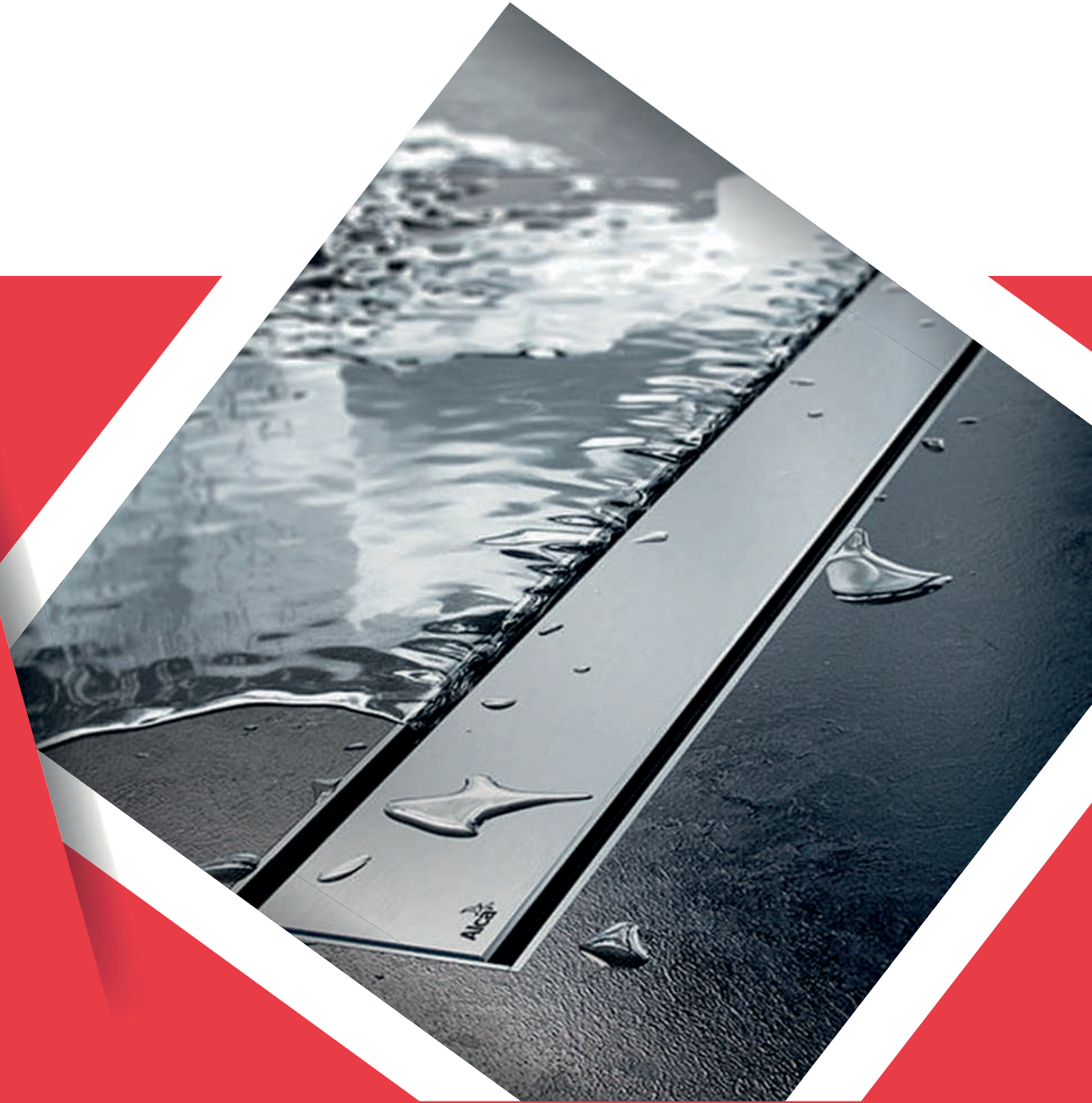
alca





AGV1S
OLUČNI SLIVNIK

ŠIFRA VOKEL	PAKIRANJE	ŠIFRA ARTIKLA
0528253	1	AGV1S

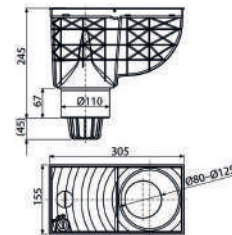

APZ19
PVC TUŠ KANALICA S DVOSTRANOM INOX REŠETKOM

ŠIFRA VOKEL	DULJINA/mm	ŠIFRA ARTIKLA
0528254	550	APZ19-550
0528255	650	APZ19-650
0528256	750	APZ19-750
0528257	850	APZ19-850
0528258	950	APZ19-950

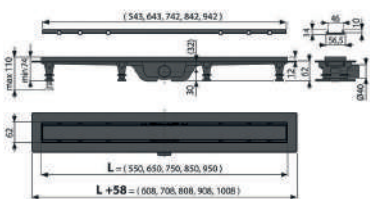

A55K-G-B
SIFON ZA KADU-ZLATNI

ŠIFRA VOKEL	PAKIRANJE (kom)	DUŽINA POTEZNE SAJLE (cm)	ŠIFRA ARTIKLA
0528259	20	57	A55K-G-B

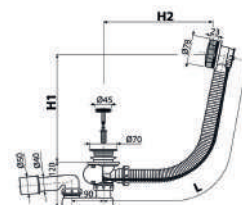

A55BLACK-80
SIFON ZA KADU-CRNI MAT

ŠIFRA VOKEL	PAKIRANJE (kom)	DUŽINA POTEZNE SAJLE (cm)	ŠIFRA ARTIKLA
0528260	12	80	A55BLACK-80

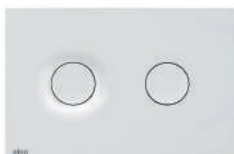
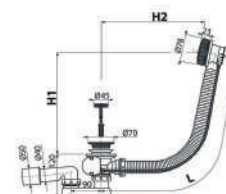

ŠIFRA VOKEL	BOJA	PAKIRANJE	ŠIFRA ARTIKLA
0528261	BIJELA	1	M1976

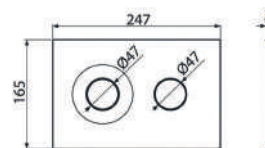

APZ101BLACK
TUŠ KANALICA SA SKRAĆENIM SIFONOM

ŠIFRA VOKEL	DULJINA/mm	ŠIFRA ARTIKLA
0528264	550	APZ101BLACK-550
0528265	650	APZ101BLACK-650
0528266	750	APZ101BLACK-750

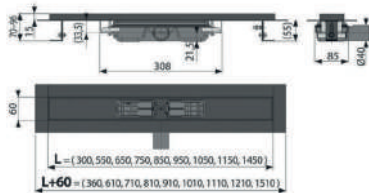

**** Instalacija Easy serije je moguća isključivo ljepljenjem na zid (bez bušenja).**



VJEŠALICA

45 x 45 x 31 mm

ŠIFRA VOKEL	BOJA	ŠIFRA ARTIKLA	PAKIRANJE
1160176	CRNA	163106360	1



DRŽAČ WC PAPIRA

100 x 145 x 42 mm

ŠIFRA VOKEL	BOJA	ŠIFRA ARTIKLA	PAKIRANJE
1160178	CRNA	163112020	1



DRŽAČ WC ČETKE

97 x 80 x 355 mm

ŠIFRA VOKEL	BOJA	ŠIFRA ARTIKLA	PAKIRANJE
1160180	CRNA	163113060	1



DRŽAČ RUČNIKA

645 x 72 x 74 mm

ŠIFRA VOKEL	BOJA	ŠIFRA ARTIKLA	PAKIRANJE
1160182	CRNA	163104240	1



VJEŠALICA

45 x 45 x 31 mm

ŠIFRA VOKEL	BOJA	ŠIFRA ARTIKLA	PAKIRANJE
1160177	KROM	163106361	1



DRŽAČ WC PAPIRA

100 x 145 x 42 mm

ŠIFRA VOKEL	BOJA	ŠIFRA ARTIKLA	PAKIRANJE
1160179	KROM	163112021	1



DRŽAČ WC ČETKE

97 x 80 x 355 mm

ŠIFRA VOKEL	BOJA	ŠIFRA ARTIKLA	PAKIRANJE
1160181	KROM	163113061	1



DRŽAČ RUČNIKA

645 x 72 x 74 mm

ŠIFRA VOKEL	BOJA	ŠIFRA ARTIKLA	PAKIRANJE
1160183	KROM	163104241	1



KATALOG PROIZVODA

VENTILATOR TEXO AIR PRO

ŠIFRA VOKEL	MODEL	BOJA	ŠIFRA ARTIKLA
0527062	AIR PRO 100-ZAKRIVLJENI	BIJELA	004-606
0527072	AIR PRO 120-ZAKRIVLJENI	BIJELA	004-616

VENTILATOR TEXO AIR PRO

 MOGUĆNOST BOJANJA

ŠIFRA VOKEL	MODEL	ŠIFRA ARTIKLA
0527063	AIR PRO 100	004-607
0527073	AIR PRO 120	004-617

VENTILATOR TEXO AIR PRO

ŠIFRA VOKEL	MODEL	BOJA	ŠIFRA ARTIKLA
0527064	AIR PRO 100	SILVER	004-608
0527074	AIR PRO 120	SILVER	004-618

VENTILATOR TEXO AIR PRO

ŠIFRA VOKEL	MODEL	BOJA	ŠIFRA ARTIKLA
0527065	AIR PRO 100	GOLD	004-609
0527075	AIR PRO 120	GOLD	004-619

VENTILATOR TEXO AIR PRO

ŠIFRA VOKEL	MODEL	BOJA	ŠIFRA ARTIKLA
0527066	AIR PRO 100	SATEN	004-610
0527076	AIR PRO 120	SATEN	004-620

VENTILATORI



VENTILATOR TEXO AIR PRO

ŠIFRA VOKEL	MODEL	BOJA	ŠIFRA ARTIKLA
0527067	AIR PRO 100	KROM	004-611
0527077	AIR PRO 120	KROM	004-621



VENTILATOR TEXO AIR PRO

ŠIFRA VOKEL	MODEL	BOJA	ŠIFRA ARTIKLA
0527068	AIR PRO 100-RAVNI	BIJELA	004-612
0527078	AIR PRO 120-RAVNI	BIJELA	004-622



VENTILATOR TEXO AIR PRO

ŠIFRA VOKEL	MODEL	BOJA	ŠIFRA ARTIKLA
0527069	AIR PRO 100	BIJELO STAKLO	004-613
0527079	AIR PRO 120	BIJELO STAKLO	004-623



VENTILATOR TEXO AIR PRO

ŠIFRA VOKEL	MODEL	BOJA	ŠIFRA ARTIKLA
0527070	AIR PRO 100	CRNO STAKLO	004-614
0527080	AIR PRO 120	CRNO STAKLO	004-624

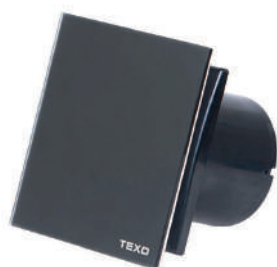

VENTILATOR TEXO AIR PRO

POSTAVLJANJE PLOČICE

ŠIFRA VOKEL	MODEL	BOJA	ŠIFRA ARTIKLA
0527071	AIR PRO 100	CRNA	004-615
0527081	AIR PRO 120	CRNA	004-625



VENTILATOR TEXO AIR PRO

ZAKRIVLJENI S TAJMEROM

ŠIFRA VOKEL	MODEL	BOJA	ŠIFRA ARTIKLA
0527082	AIR PRO 120	BIJELA	004-626

CU CIJEV S UV IZOLACIJOM ZA KLIME

VOKEL ŠIFRA	DIMENZIJA (")	DIMENZIJA (mm)	ARTIKAL
1477017	1/4"	6,35x0,8	2FR99A307001Q1450
1477018	3/8"	9,52x0,8	2FR99A307101Q1490
1477019	1/2"	12,7x0,8	2FR99A303701Q1530
1477020	5/8"	15,87x0,8	2FR99A307701Q1590



SIFON ZA SUDOPER JEDNODJELNI

VOKEL ŠIFRA	BOJA	ARTIKAL
0533001	BIJELA	960001



SIFON ZA UMIVAONIK

VOKEL ŠIFRA	BOJA	ARTIKAL
0533002	BIJELA	960003



SIFON NASTAVAK L-500

VOKEL ŠIFRA	BOJA	DIMENZIJA	ARTIKAL
0533003	BIJELA	5/4"	960026
0533004	BIJELA	6/4"	960052



BALTIK VEZA FLEX FI110

VOKEL ŠIFRA	BOJA	ARTIKAL
0533005	BIJELA	960117

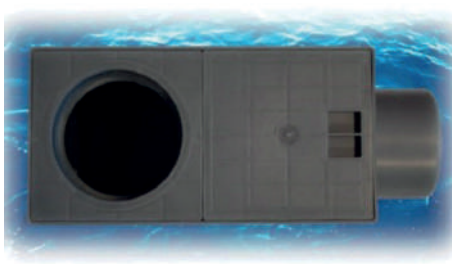

PJESKOLOVAC

VOKEL ŠIFRA	BOJA	ARTIKAL
0533006	BIJELA	8004957



www.vokel.com



Vokeldoo



Sjedište tvrtke (BIH)

Vokel d.o.o.
 Vinjani b.b.
 88240 Posušje
 +387 39 693 001
 vokel@vokel.com

Podružnica (HR)

Vokel d.o.o.
 Bleiburška ulica 131
 21260 Imotski
 +385 21 582 427
 vokel@vokel.com

Vokel partner (MNE)

Feroplet d.o.o.
 Druge Dalmatinske 5
 85340 Herceg Novi
 +382 31 580 052
 office@feroplet.me

Podružnice: (BIH)

Vokel d.o.o. Brčko

Grbavica b.b.
 +387 49 213 874
 brcko@vokel.com

Vokel d.o.o. Sarajevo

Kurta Schorka 5a-Stup
 +387 33 768 605
 sarajevo@vokel.com

Vokel d.o.o. Trn-Laktaši

Cara Dušana 74
 +387 51 507 300
 banjaluka@vokel.com

Vokel d.o.o. Derventa

Željeznička 12G
 +387 53 822 839
 derventa@vokel.com

Vokel d.o.o. Livno

Župana Želimira b.b.
 +387 34 202 665
 livno@vokel.com

Vokel d.o.o. Trebinje

Todorići b.b.
 +387 59 490 210
 trebinje@vokel.com

Vokel d.o.o. Bijeljina

Ljeljenča b.b.
 +387 55 256 050
 bijeljina@vokel.com

Vokel d.o.o. Mostar

Bišće Polje b.b.
 +387 36 351 900
 mostar@vokel.com

Vokel d.o.o. Bijać

Pritoka b.b.
 +387 37 328 128
 bihac@vokel.com

Vokel d.o.o. Prijedor

Svale b.b.
 +387 52 243 810
 prijedor@vokel.com

Vokel d.o.o. Bosanska Krupa

Unska b.b.
 +387 37 489 589
 bosanskakrupa@vokel.com

Vokel d.o.o. Jajce

Skela b.b.
 +387 30 654 088
 jajce@vokel.com

Vokel d.o.o. Tuzla

Mitra Trifunovića Uče 1
 +387 35 398 580
 tuzla@vokel.com

Vokel d.o.o. Sanski Most

Bulevar 7. Korpusa b.b.
 +387 37 681 134
 sanskimost@vokel.com